

Mini TOPLED® RG

LS M770, LO M770, LY M770
LG M770, LP M770

Besondere Merkmale

- Gehäusefarbe: weiß
- als optischer Indikator einsetzbar
- zur Hinterleuchtung, Lichtleiter- und Linseneinkopplung
- für alle SMT-Bestück- und Löttechniken geeignet
- gegurtet (12-mm-Filmgurt)
- Störimpulsfest nach DIN 40839

Features

- color of package: white
- for use as optical indicator
- for backlighting, optical coupling into light pipes and lenses
- suitable for all SMT assembly and soldering methods
- available taped on reel (12 mm tape)
- load dump resistant acc. to DIN 40839

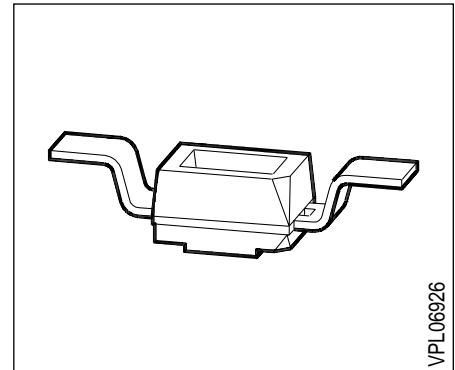

| Typ | Emissions- farbe | Farbe der Lichtaustritts- fläche | Lichtstärke | Lichtstrom | Bestellnummer |
|--|----------------------|--|---|---|--|
| Type | Color of Emission | Color of the Light Emitting Area | Luminous Intensity $I_F = 10 \text{ mA}$ $I_V \text{ (mcd)}$ | Luminous Flux $I_F = 10 \text{ mA}$ $\Phi_V \text{ (mlm)}$ | Ordering Code |
| LS M770-HK LS M770-J LS M770-K LS M770-JM | super-red | colorless clear | 2.5 ... 12.5 4.0 ... 8.0 6.3 ... 12.5 4.0 ... 32.0 | - 18 (typ.) 30 (typ.) - | Q62703-Q3326 Q62703-Q3327 Q62703-Q3328 Q62703-Q3329 |
| LO M770-HK LO M770-J LO M770-K LO M770-JM | orange | colorless clear | 2.5 ... 12.5 4.0 ... 8.0 6.3 ... 12.5 4.0 ... 32.0 | - 18 (typ.) 30 (typ.) - | Q62703-Q3330 Q62703-Q3331 Q62703-Q3332 Q62703-Q3333 |
| LY M770-HK LY M770-J LY M770-K LY M770-JM | yellow | colorless clear | 2.5 ... 12.5 4.0 ... 8.0 6.3 ... 12.5 4.0 ... 32.0 | - 18 (typ.) 30 (typ.) - | Q62703-Q3334 Q62703-Q3336 Q62703-Q3335 Q62703-Q3337 |
| LG M770-HK LG M770-J LG M770-K LG M770-JM | green | colorless clear | 2.5 ... 12.5 4.0 ... 8.0 6.3 ... 12.5 4.0 ... 32.0 | - 18 (typ.) 30 (typ.) - | Q62703-Q3338 Q62703-Q3339 Q62703-Q3340 Q62703-Q3341 |
| LP M770-FJ LP M770-G LP M770-H LP M770-GK | pure green | colorless clear | 1.0 ... 8.0 1.6 ... 3.2 2.5 ... 5.0 1.6 ... 12.5 | - 8 (typ.) 12 (typ.) - | Q62703-Q3342 Q62703-Q3343 Q62703-Q3344 Q62703-Q3345 |

Streuung der Lichtstärke in einer Verpackungseinheit $I_{V \max} / I_{V \min} \leq 2.0$.

Luminous intensity ratio in one packaging unit $I_{V \max} / I_{V \min} \leq 2.0$.

Grenzwerte Maximum Ratings

| Bezeichnung Parameter | Symbol Symbol | Werte Values | Einheit Unit |
|---|------------------|-----------------|-----------------|
| Betriebstemperatur Operating temperature range | T_{op} | - 55 ... + 100 | °C |
| Lagertemperatur Storage temperature range | T_{stg} | - 55 ... + 100 | °C |
| Sperrschichttemperatur Junction temperature | T_j | + 100 | °C |
| Durchlaßstrom Forward current | I_F | 30 | mA |
| Stoßstrom Surge current $t \leq 10 \mu s, D = 0.005$ | I_{FM} | 0.5 | A |
| Sperrspannung Reverse voltage | V_R | 5 | V |
| Verlustleistung Power dissipation | P_{tot} | 100 | mW |
| Wärmewiderstand Thermal resistance Sperrschicht / Umgebung Junction / air Montage auf PC-board*) (Padgröße $\geq 16 \text{ mm}^2$) mounted on PC board*) (pad size $\geq 16 \text{ mm}^2$) | $R_{th JA}$ | 530 | K/W |

*) PC-board: FR4

Kennwerte ($T_A = 25\text{ °C}$)

Characteristics

| Bezeichnung Parameter | Symbol Symbol | Werte Values | | | | | Einheit Unit |
|---|-------------------------|-----------------|------------|------------|------------|------------|--------------------------------|
| | | LS | LO | LY | LG | LP | |
| Wellenlänge des emittierten Lichtes (typ.) Wavelength at peak emission (typ.) $I_F = 10\text{ mA}$ | λ_{peak} | 635 | 610 | 586 | 565 | 557 | nm |
| Dominantwellenlänge (typ.) Dominant wavelength (typ.) $I_F = 10\text{ mA}$ | λ_{dom} | 628 | 605 | 590 | 570 | 560 | nm |
| Spektrale Bandbreite bei 50 % $I_{\text{rel max}}$ (typ.) Spectral bandwidth at 50 % $I_{\text{rel max}}$ (typ.) $I_F = 10\text{ mA}$ | $\Delta\lambda$ | 45 | 40 | 45 | 25 | 22 | nm |
| Abstrahlwinkel bei 50 % I_v (Vollwinkel) Viewing angle at 50 % I_v | 2ϕ | 120 | 120 | 120 | 120 | 120 | Grad deg. |
| Durchlaßspannung (typ.) Forward voltage (max.) $I_F = 10\text{ mA}$ | V_F V_F | 2.0 2.6 | 2.0 2.6 | 2.0 2.6 | 2.0 2.6 | 2.0 2.6 | V V |
| Sperrstrom (typ.) Reverse current (max.) $V_R = 5\text{ V}$ | I_R I_R | 0.01 10 | 0.01 10 | 0.01 10 | 0.01 10 | 0.01 10 | μA μA |
| Kapazität (typ.) Capacitance $V_R = 0\text{ V}, f = 1\text{ MHz}$ | C_0 | 12 | 8 | 10 | 15 | 15 | pF |
| Schaltzeiten: Switching times: I_v from 10 % to 90 % (typ.) I_v from 90 % to 10 % (typ.) $I_F = 100\text{ mA}, t_p = 10\text{ }\mu\text{s}, R_L = 50\text{ }\Omega$ | t_r t_f | 300 150 | 300 150 | 300 150 | 450 200 | 450 200 | ns ns |

Relative spektrale Emission $I_{rel} = f(\lambda)$, $T_A = 25\text{ °C}$, $I_F = 10\text{ mA}$

Relative spectral emission

$V(\lambda)$ = spektrale Augenempfindlichkeit

Standard eye response curve

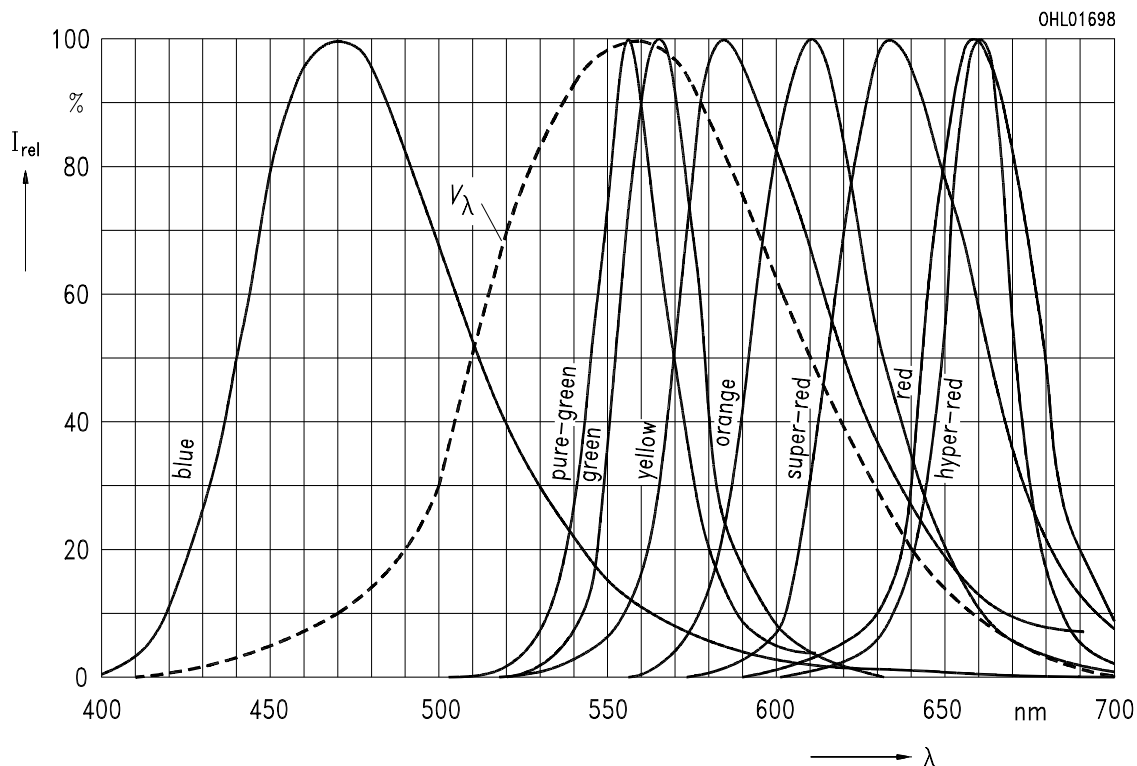

Abstrahlcharakteristik $I_{rel} = f(\varphi)$

Radiation characteristic

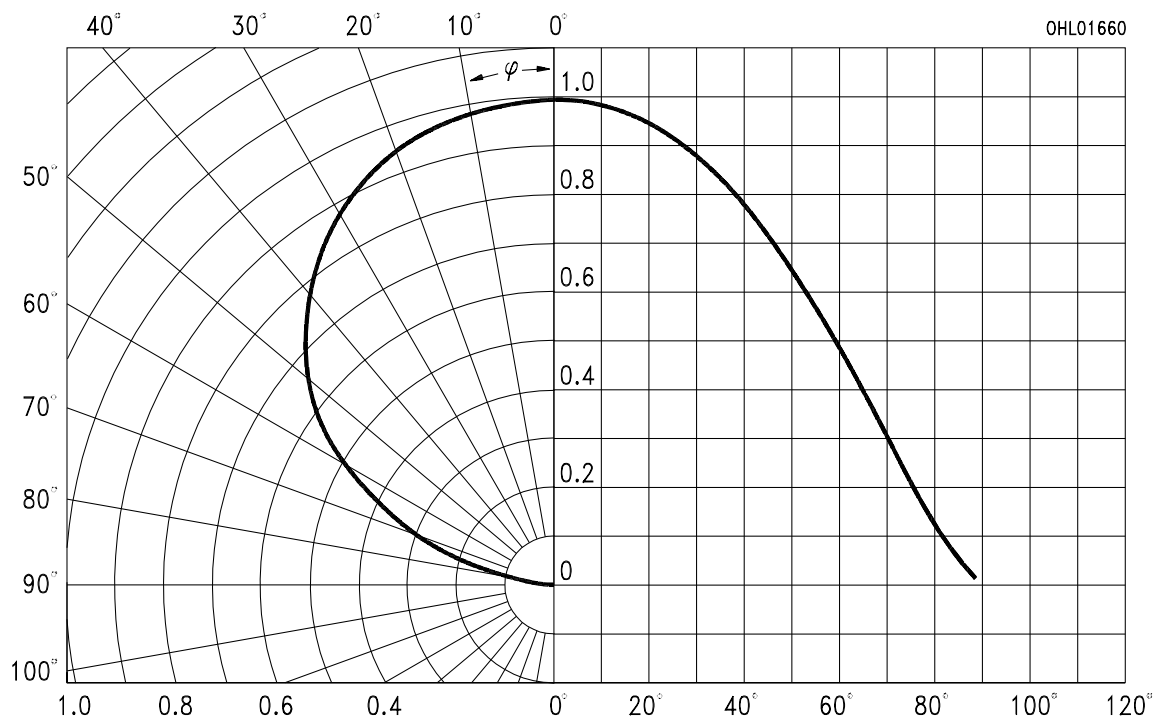

Durchlaßstrom $I_F = f(V_F)$

Forward current

$T_A = 25^\circ\text{C}$

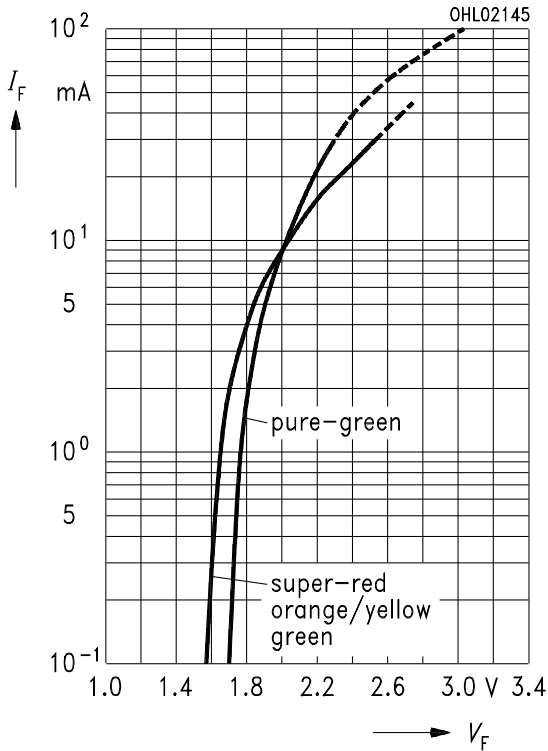

Relative Lichtstärke $I_V/I_{V(10\text{mA})} = f(I_F)$

Relative luminous intensity

$T_A = 25^\circ\text{C}$

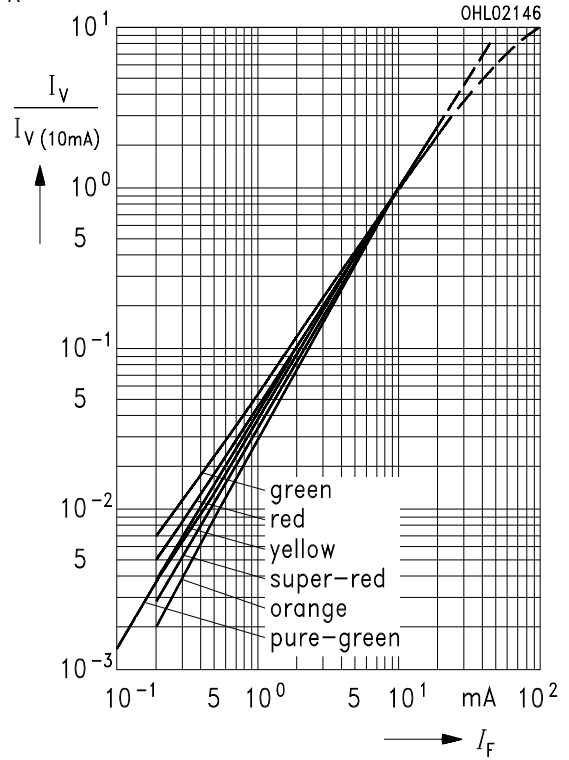

Zulässige Impulsbelastbarkeit $I_F = f(t_p)$

Permissible pulse handling capability

Duty cycle $D =$ parameter, $T_A = 25^\circ\text{C}$

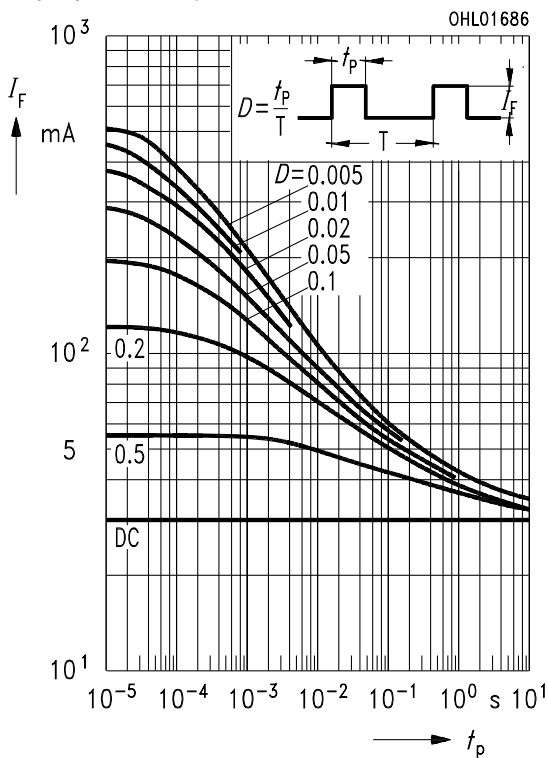

Maximal zulässiger Durchlaßstrom

Max. permissible forward current

$I_F = f(T_A)$

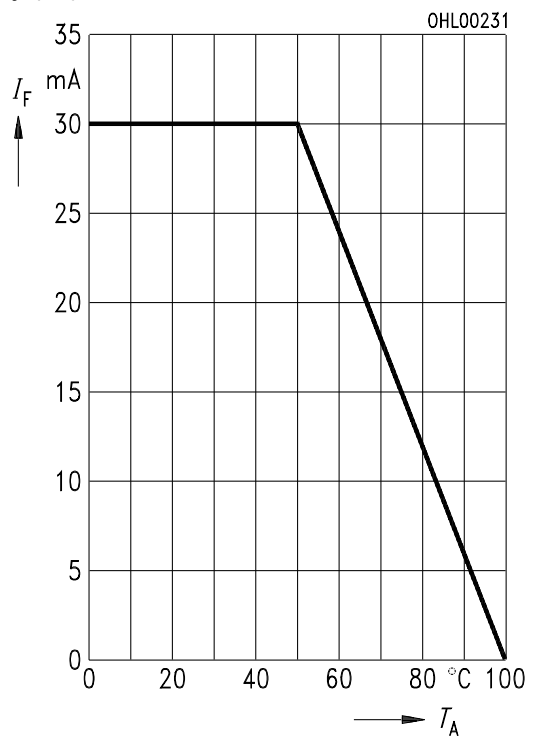

Wellenlänge der Strahlung $\lambda_{\text{peak}} = f(T_A)$
Wavelength at peak emission

$I_F = 10 \text{ mA}$

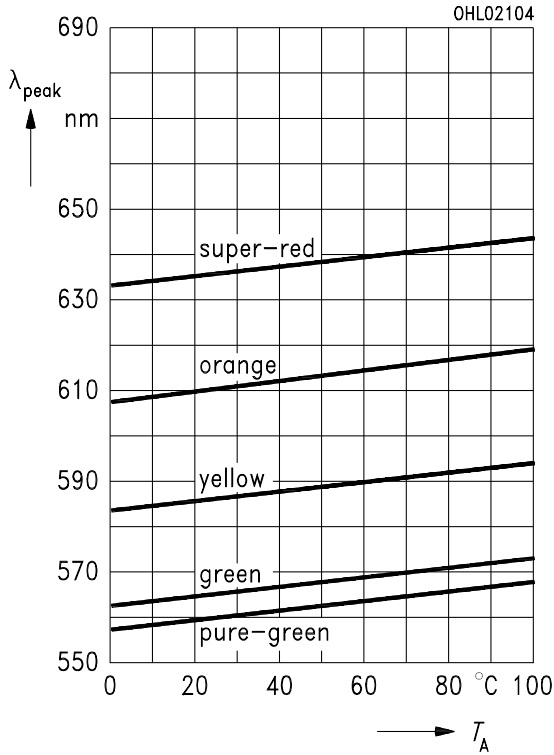

Dominantwellenlänge $\lambda_{\text{dom}} = f(T_A)$
Dominant wavelength

$I_F = 10 \text{ mA}$

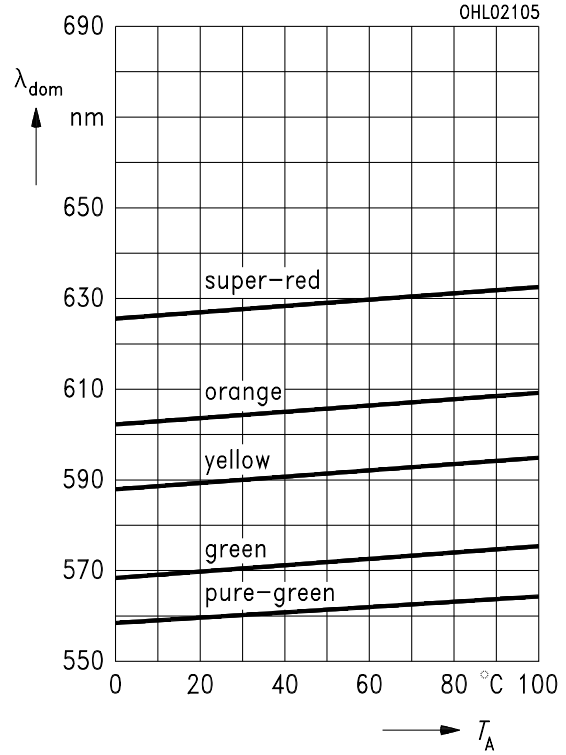

Durchlaßspannung $V_F = f(T_A)$
Forward voltage

$I_F = 10 \text{ mA}$

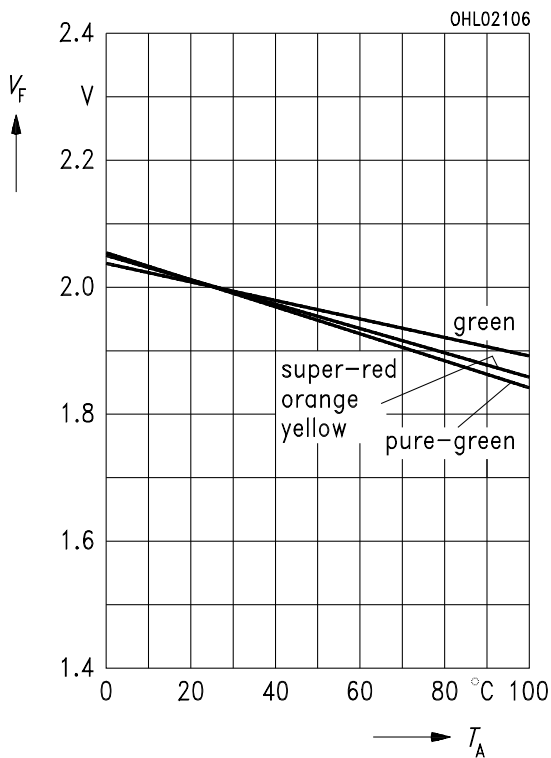

Relative Lichtstärke $I_V / I_{V(25^\circ\text{C})} = f(T_A)$
Relative luminous intensity

$I_F = 10 \text{ mA}$

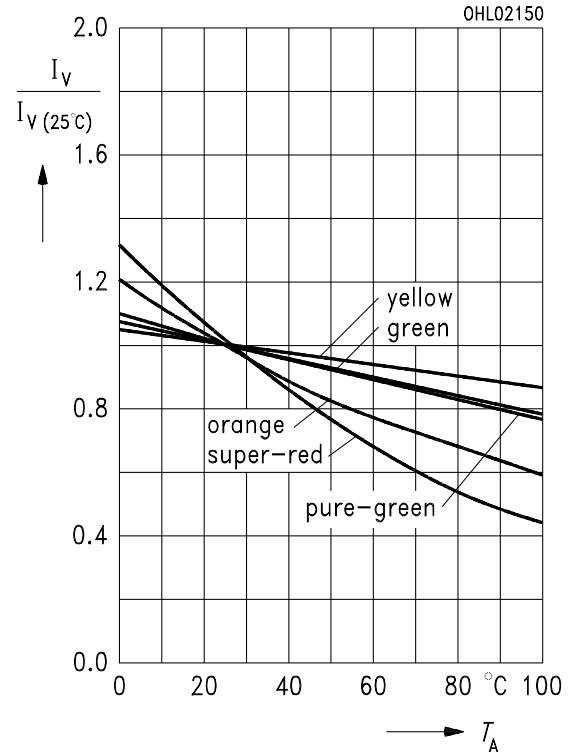

Maßzeichnung (Maße in mm, wenn nicht anders angegeben)
Package Outlines (Dimensions in mm, unless otherwise specified)

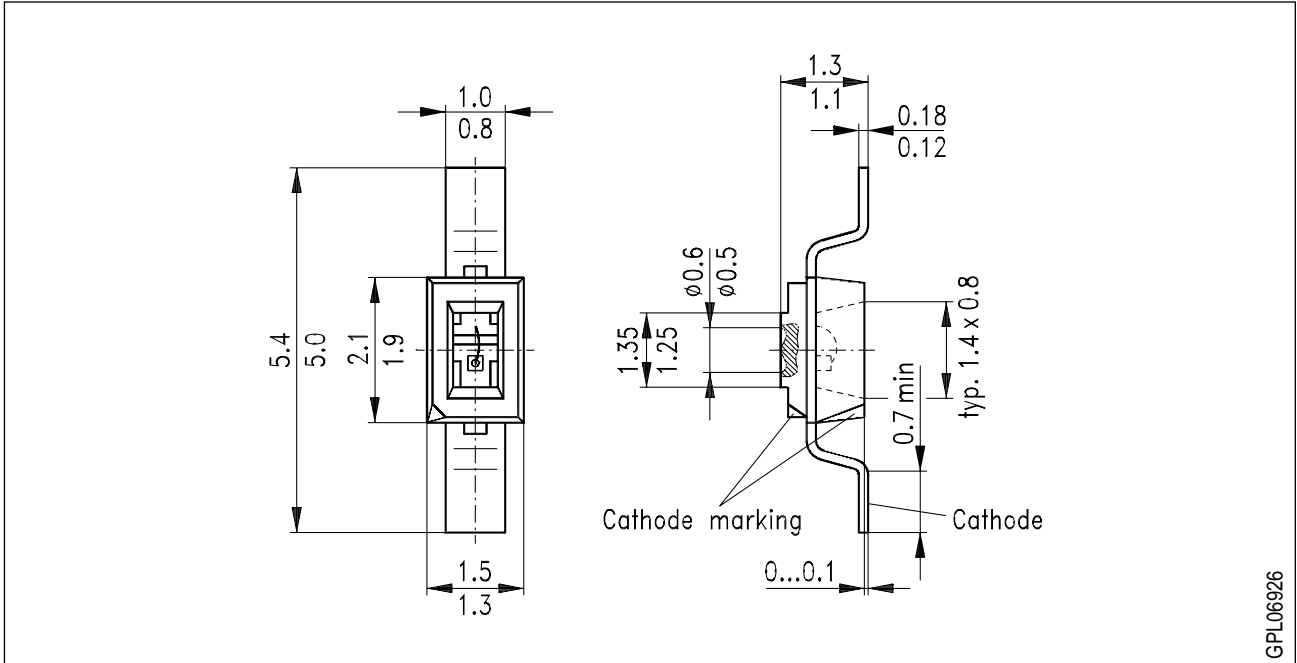

GPL06926

Kathodenkennung: abgeschrägte Ecke
Cathode mark: bevelled edge