

Plane 3 mm (T1) LED, Non Diffused

LS P380, LO P380, LY P380
LG P380, LP P380

Besondere Merkmale

- farbloses, klares Gehäuse
- zur Einkopplung in Lichtleiter
- als optischer Indikator einsetzbar
- Lötspieße mit Aufsetzebene
- gegurtet lieferbar
- Störimpulsfest nach DIN 40839

Features

- colorless, clear package
- for optical coupling into light pipes
- for use as optical indicator
- solder leads with stand-off
- available taped on reel
- load dump resistant acc. to DIN 40839

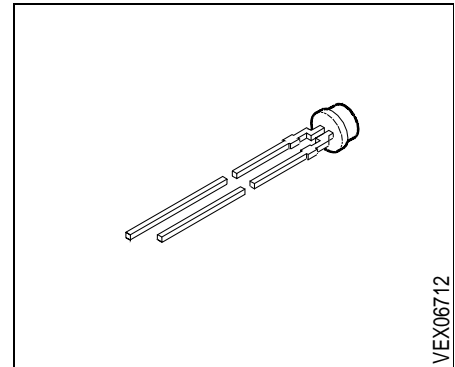

Typ Type	Emissionsfarbe Color of Emission	Gehäusefarbe Color of Package	Lichtstrom Luminous Flux $I_F = 15 \text{ mA}$ $\Phi_V (\text{mlm})$	Bestellnummer Ordering Code
LS P380-MP LS P380-N LS P380-P LS P380-NQ	super-red	red clear	16 ... 80 25 ... 50 40 ... 80 25 ... 125	Q62703-Q2466 Q62703-Q3227 Q62703-Q3228 Q62703-Q3229
LO P380-MP LO P380-N LO P380-P LO P380-NQ	orange	orange clear	16 ... 80 25 ... 50 40 ... 80 25 ... 125	Q62703-Q2465 Q62703-Q3205 Q62703-Q3206 Q62703-Q3207
LY P380-MP LY P380-N LY P380-P LY P380-NQ	yellow	yellow clear	16 ... 80 25 ... 50 40 ... 80 25 ... 125	Q62703-Q3237 Q62703-Q3238 Q62703-Q3239 Q62703-Q3240
LG P380-MP LG P380-N LG P380-P LG P380-NQ	green	green clear	16 ... 80 25 ... 50 40 ... 80 25 ... 125	Q62703-Q2463 Q62703-Q3194 Q62703-Q3195 Q62703-Q3196
LP P380-LN LP P380-M LP P380-N LP P380-MP	pure green	green clear	10 ... 50 16 ... 32 25 ... 50 16 ... 80	Q62703-Q2464 Q62703-Q2519 Q62703-Q2520 Q62703-Q3218

Streuung des Lichtstromes in einer Verpackungseinheit $\Phi_{V \max} / \Phi_{V \min} \leq 2.0$.
Luminous flux ratio in one packaging unit $\Phi_{V \max} / \Phi_{V \min} \leq 2.0$.

Grenzwerte Maximum Ratings

Bezeichnung Parameter	Symbol Symbol	Werte Values		Einheit Unit
		LS, LO, LY, LG	LP	
Betriebstemperatur Operating temperature range	T_{op}	- 55 ... + 100	- 55 ... + 100	°C
Lagertemperatur Storage temperature range	T_{stg}	- 55 ... + 100	- 55 ... + 100	°C
Sperrschichttemperatur Junction temperature	T_j	+ 100	+ 100	°C
Durchlaßstrom Forward current	I_F	40	30	mA
Stoßstrom Surge current $t \leq 10 \mu s, D = 0.005$	I_{FM}	0.5	0.5	A
Sperrspannung Reverse voltage	V_R	5	5	V
Verlustleistung Power dissipation $T_A \leq 25 \text{ °C}$	P_{tot}	140	100	mW
Wärmewiderstand Thermal resistance Sperrschicht / Luft Junction / air	R_{thJA}	400	400	K/W

Kennwerte ($T_A = 25\text{ °C}$)

Characteristics

Bezeichnung Parameter	Symbol Symbol	Werte Values					Einheit Unit
		LS	LO	LY	LG	LP	
Wellenlänge des emittierten Lichtes (typ.) Wavelength at peak emission (typ.) $I_F = 20\text{ mA}$	λ_{peak}	635	610	586	565	557	nm
Dominantwellenlänge (typ.) Dominant wavelength (typ.) $I_F = 20\text{ mA}$	λ_{dom}	628	605	590	570	560	nm
Spektrale Bandbreite bei 50 % $\Phi_{\text{rel max}}$ (typ.) spectral bandwidth at 50 % $\Phi_{\text{rel max}}$ (typ.) $I_F = 20\text{ mA}$	$\Delta\lambda$	45	40	45	25	22	nm
Durchlaßspannung (typ.) Forward voltage (max.) $I_F = 15\text{ mA}$	V_F	2.1	2.1	2.1	2.1	2.1	V
Sperrstrom (typ.) Reverse current (max.) $V_R = 5\text{ V}$	I_R	0.01	0.01	0.01	0.01	0.01	μA
Kapazität (typ.) Capacitance $V_R = 0\text{ V}, f = 1\text{ MHz}$	C_0	12	8	10	15	32	pF
Schaltzeiten: Switching times: I_V from 10 % to 90 % (typ.) I_V from 90 % to 10 % (typ.) $I_F = 100\text{ mA}, t_p = 10\text{ }\mu\text{s}, R_L = 50\text{ }\Omega$	t_r	300	300	300	450	450	ns
	t_f	150	150	150	200	200	ns

Relative spektrale Emission $\Phi_{rel} = f(\lambda)$, $T_A = 25\text{ °C}$, $I_F = 20\text{ mA}$

Relative spectral emission

$V(\lambda)$ = spektrale Augenempfindlichkeit

Standard eye response curve

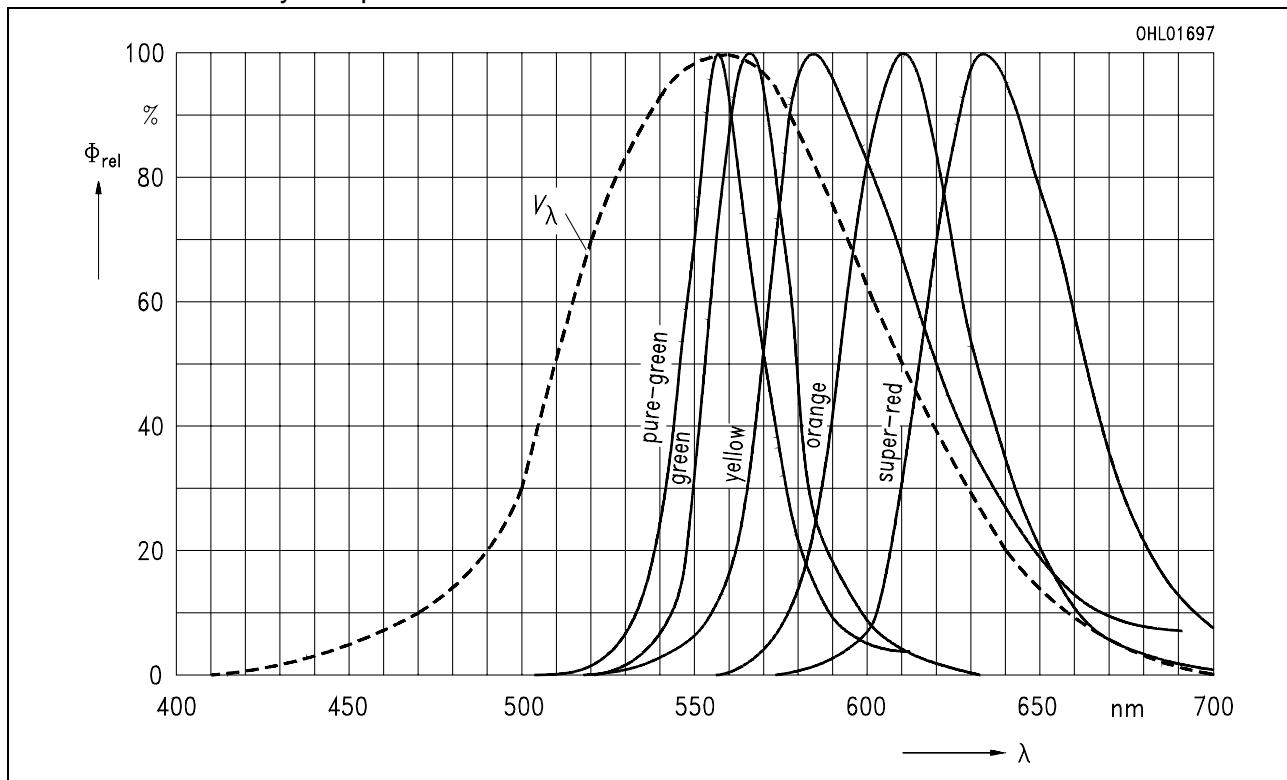

Abstrahlcharakteristik $\Phi_{rel} = f(\varphi)$

Radiation characteristic

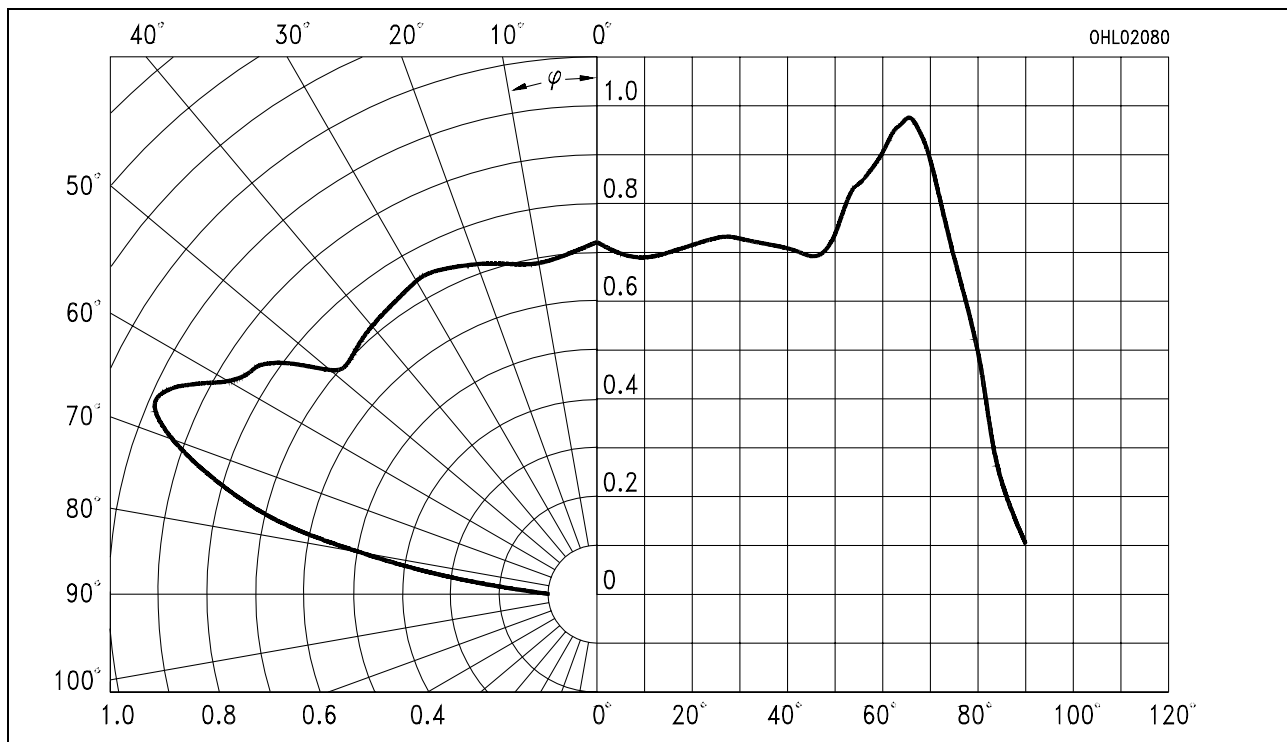

Durchlaßstrom $I_F = f(V_F)$

Forward current

$T_A = 25\text{ °C}$

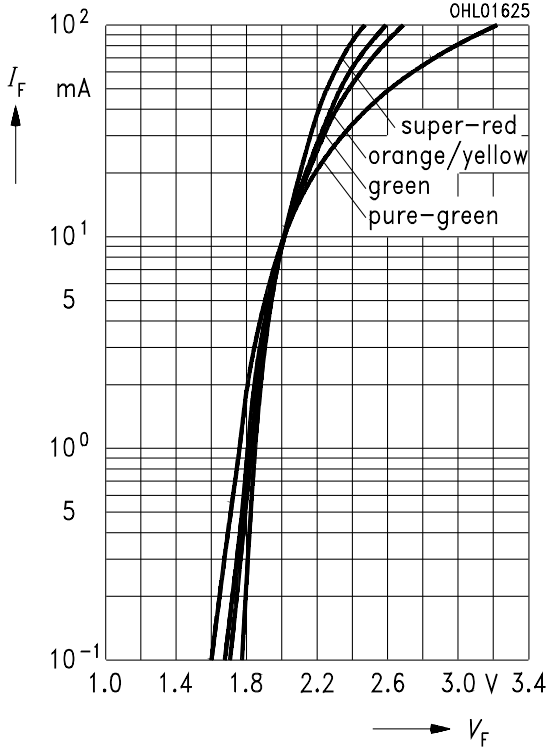

Relativer Lichtstrom $\Phi_V / \Phi_{V(15\text{ mA})} = f(I_F)$

Relative luminous flux

$T_A = 25\text{ °C}$

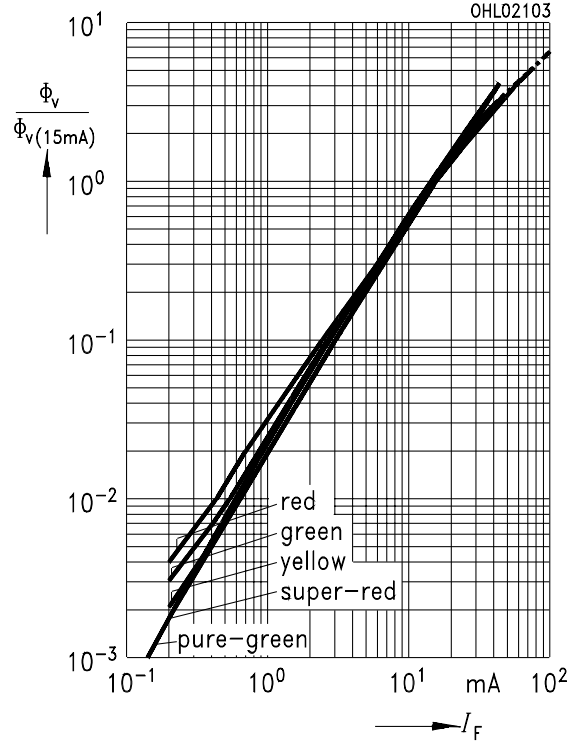

Zulässige Impulsbelastbarkeit $I_F = f(t_p)$

Permissible pulse handling capability

Duty cycle $D =$ parameter, $T_A = 25\text{ °C}$

LS, LO, LY, LG

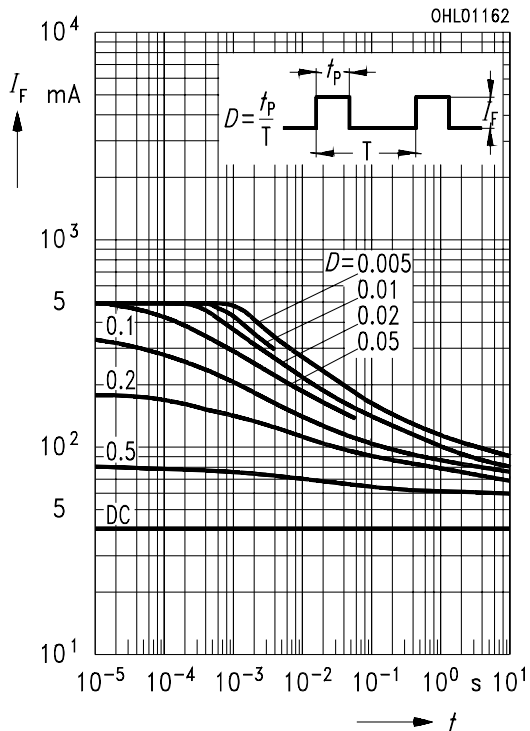

Zulässige Impulsbelastbarkeit $I_F = f(t_p)$

Permissible pulse handling capability

Duty cycle $D =$ parameter, $T_A = 25\text{ °C}$

LP

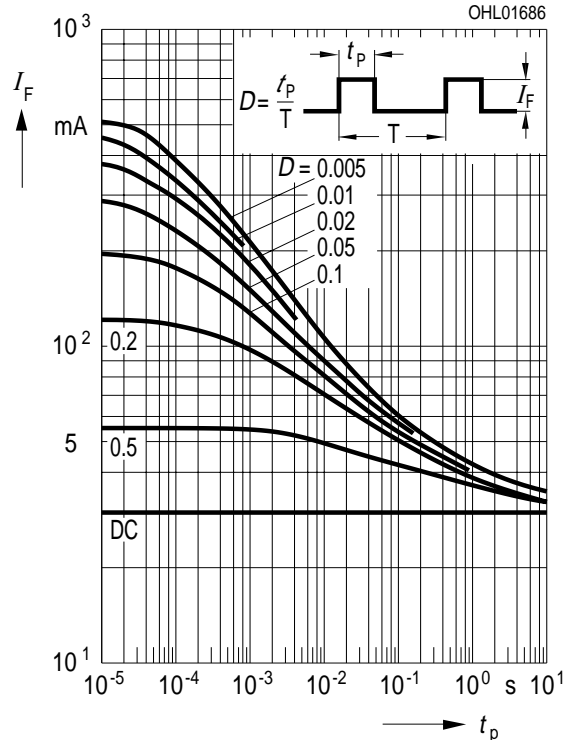

Maximal zulässiger Durchlaßstrom $I_F = f(T_A)$
Max. permissible forward current
LS, LO, LY, LG

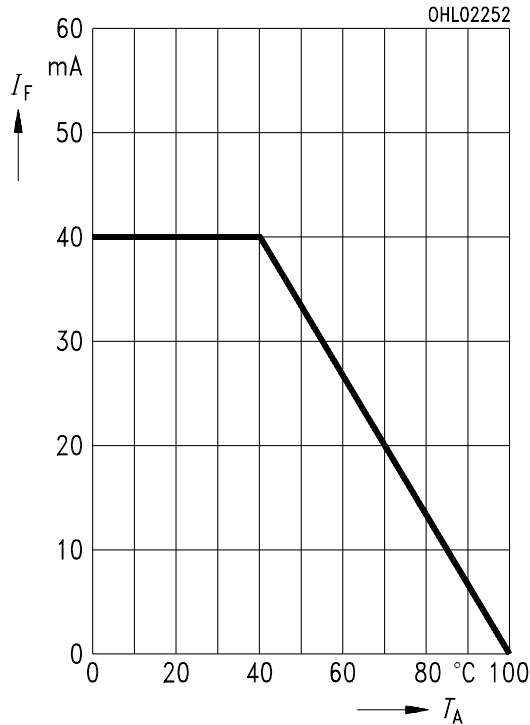

Maximal zulässiger Durchlaßstrom $I_F = f(T_A)$
Max. permissible forward current
LP

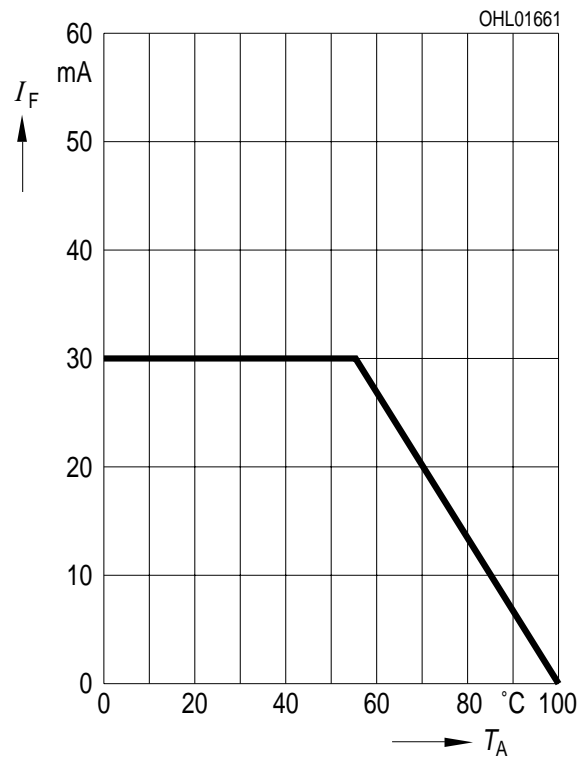

Wellenlänge der Stahlung $\lambda_{\text{peak}} = f(T_A)$
Wavelength at peak emission
 $I_F = 20 \text{ mA}$

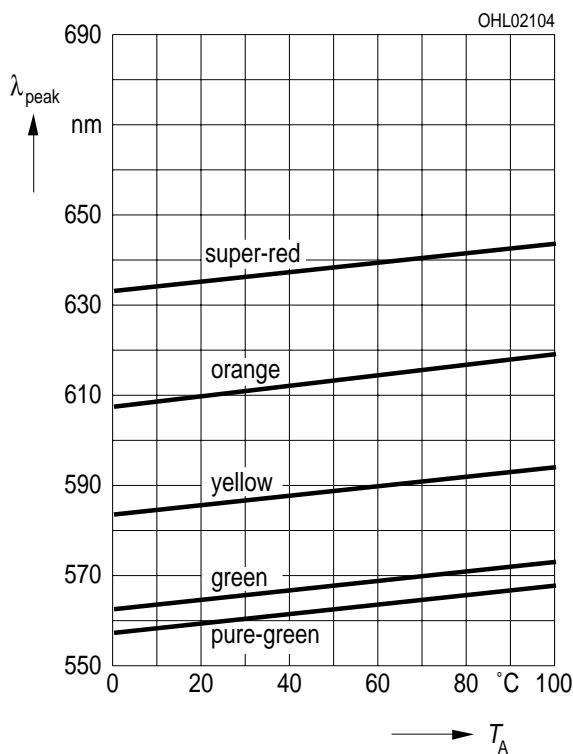

Dominantwellenlänge $\lambda_{\text{dom}} = f(T_A)$
Dominant wavelength
 $I_F = 20 \text{ mA}$

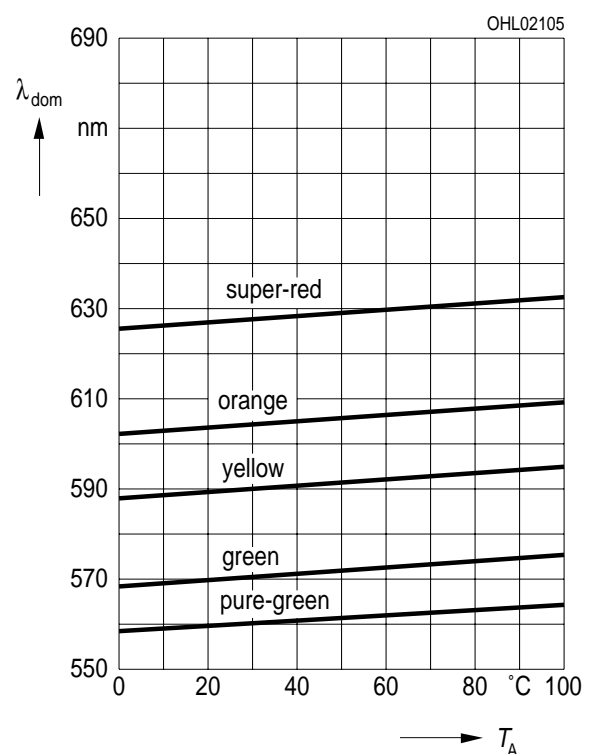

Durchlaßspannung $V_F = f(T_A)$

Forward voltage

$I_F = 15 \text{ mA}$

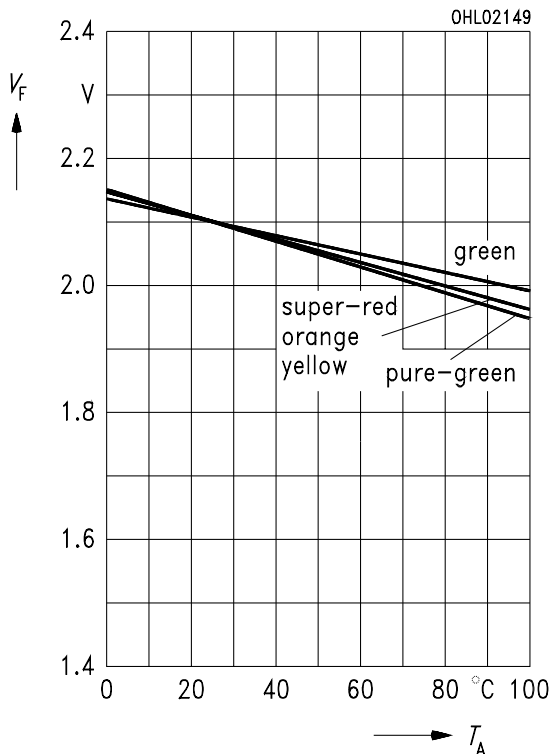

Relativer Lichtstrom $\Phi_V / \Phi_{V(25^\circ\text{C})} = f(T_A)$

Relative luminous flux

$I_F = 15 \text{ mA}$

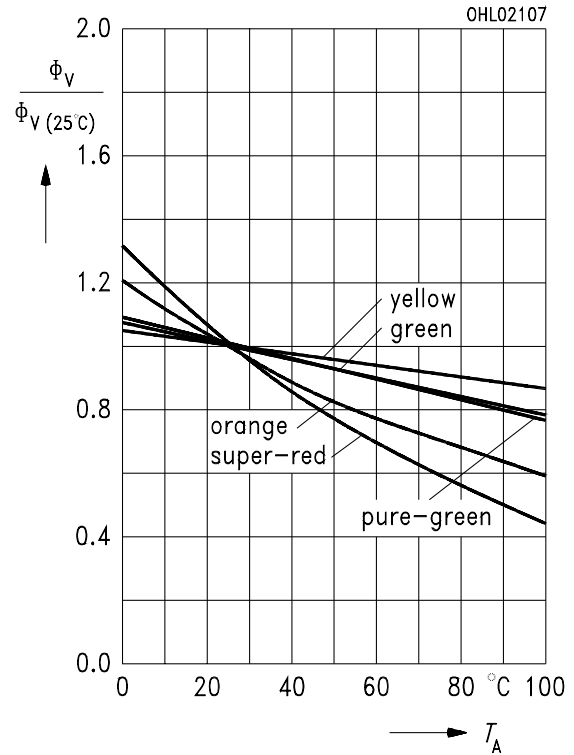

Maßzeichnung
Package Outlines

(Maße in mm, wenn nicht anders angegeben)
(Dimensions in mm, unless otherwise specified)

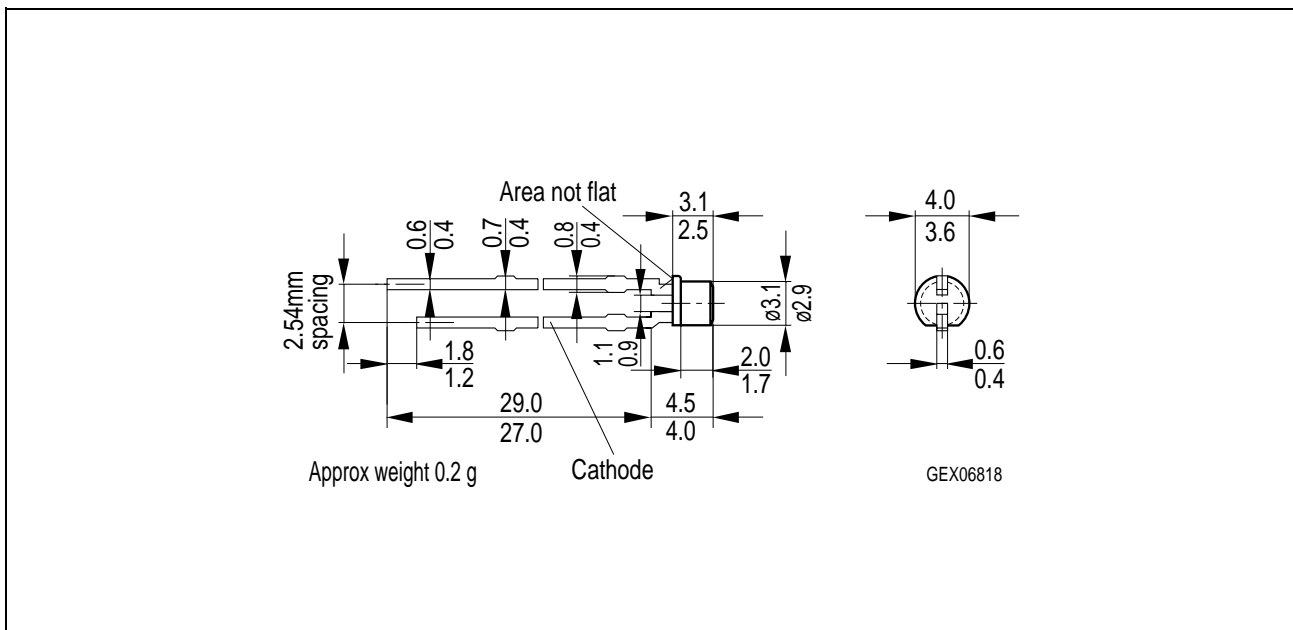

Kathodenkennzeichnung: Kürzerer Lötspieß
Cathode mark: Short solder lead