

Product Specification

SPECIFICATION FOR APPROVAL

- () Preliminary Specification
- (◆) Final Specification

Title	14.1" WXGA TFT LCD
-------	--------------------

Customer	TOSHIBA
MODEL	

SUPPLIER	LG.Philips LCD Co., Ltd.
*MODEL	LP141WX3
Suffix	TLN1

*When you obtain standard approval, please use the above model name without suffix

APPROVED BY	SIGNATURE
/	_____
/	_____
/	_____

Please return 1 copy for your confirmation with your signature and comments.

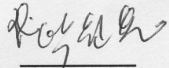
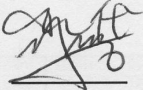
APPROVED BY	SIGNATURE
K.S. Kwon / G.Manager	
REVIEWED BY	
W.Y. Park / Manager	
PREPARED BY	
M.K. Bae / Engineer J.W. Kim / Engineer	

Products Engineering Dept.
LG. Philips LCD Co., Ltd

Product Specification

Contents

No	ITEM	Page
	COVER	1
	CONTENTS	2
	RECORD OF REVISIONS	3
1	GENERAL DESCRIPTION	4
2	ABSOLUTE MAXIMUM RATINGS	5
3	ELECTRICAL SPECIFICATIONS	
3-1	ELECTRICAL CHARACTREISTICS	6
3-2	INTERFACE CONNECTIONS	8
3-3	LVDS SIGNAL TIMING SPECIFICATIONS	9
3-4	SIGNAL TIMING SPECIFICATIONS	11
3-5	SIGNAL TIMING WAVEFORMS	11
3-6	COLOR INPUT DATA REFERNECE	12
3-7	POWER SEQUENCE	13
4	OPTICAL SFECIFICATIONS	14
5	MECHANICAL CHARACTERISTICS	17
6	RELIABLITY	24
7	INTERNATIONAL STANDARDS	
7-1	SAFETY	25
7-2	EMC	25
8	PACKING	
8-1	DESIGNATION OF LOT MARK	26
8-2	PACKING FORM	26
9	PRECAUTIONS	27
A	APPENDIX. Enhanced Extended Display Identification Data	29

Product Specification

1. General Description

The LP141WX3 is a Color Active Matrix Liquid Crystal Display with an integral Cold Cathode Fluorescent Lamp (CCFL) backlight system. The matrix employs a-Si Thin Film Transistor as the active element. It is a transmissive type display operating in the normally white mode. This TFT-LCD has 14.1 inches diagonally measured active display area with WXGA resolution(800 vertical by 1280 horizontal pixel array). Each pixel is divided into Red, Green and Blue sub-pixels or dots which are arranged in vertical stripes. Gray scale or the brightness of the sub-pixel color is determined with a 6-bit gray scale signal for each dot, thus, presenting a palette of more than 262,144 colors.

The LP141WX3 has been designed to apply the interface method that enables low power, high speed, low EMI.

The LP141WX3 is intended to support applications where thin thickness, low power are critical factors and graphic displays are important. In combination with the vertical arrangement of the sub-pixels, the LP141WX3 characteristics provide an excellent flat display for office automation products such as Notebook PC.

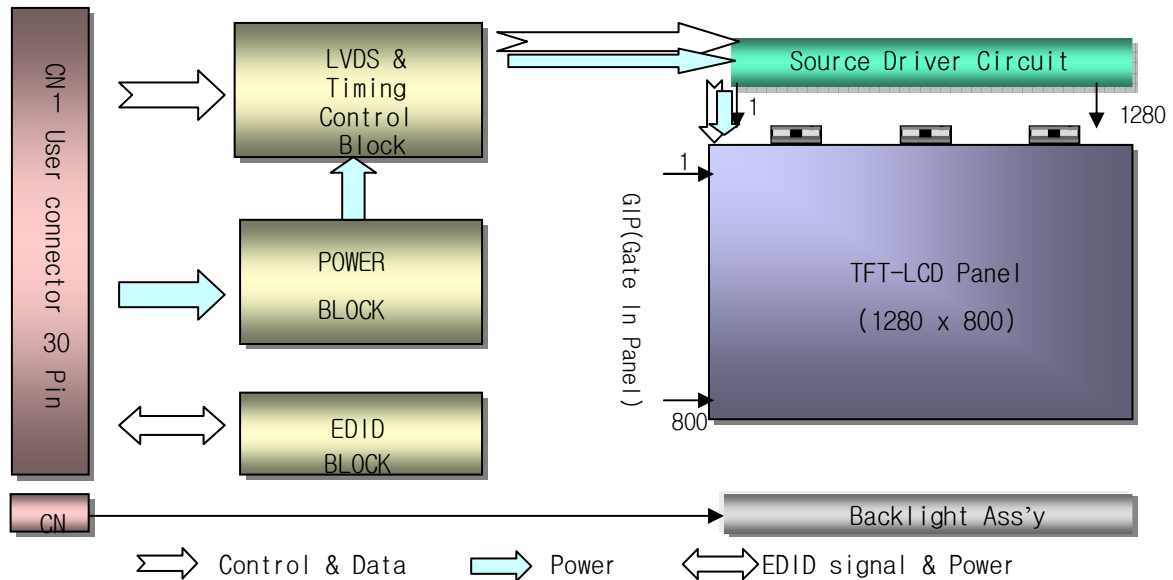

General Features

Active Screen Size	14.1 inches diagonal
Outline Dimension	319.5(H,Typ.) × 205.5(V,Typ.) × 5.5(D,Max) [mm]
Pixel Pitch	0.2373mm × 0.2373 mm
Pixel Format	1280 horiz. By 800 vert. Pixels RGB strip arrangement
Color Depth	6-bit, 262,144 colors
Luminance, White	200 cd/m ² (Typ.5 point)
Power Consumption	Total 5.2 Watt(Typ.) @ LCM circuit 1.2 Watt(Typ._Mosaic), B/L input 4.0Watt(Typ.)
Weight	400g(Max.)
Display Operating Mode	Transmissive mode, normally white
Surface Treatment	Glare treatment of the front polarizer
RoHS Comply	Yes

Product Specification

2. Absolute Maximum Ratings

The following are maximum values which, if exceeded, may cause faulty operation or damage to the unit.

Table 1. ABSOLUTE MAXIMUM RATINGS

Parameter	Symbol	Values		Units	Notes
		Min	Max		
Power Input Voltage	VCC	-0.3	4.0	Vdc	at 25 ± 5°C
Operating Temperature	TOP	0	50	°C	1
Storage Temperature	HST	-20	60	°C	1
Operating Ambient Humidity	HOP	10	90	%RH	1
Storage Humidity	HST	10	90	%RH	1

Note : 1. Temperature and relative humidity range are shown in the figure below.
 Wet bulb temperature should be 39°C Max, and no condensation of water.

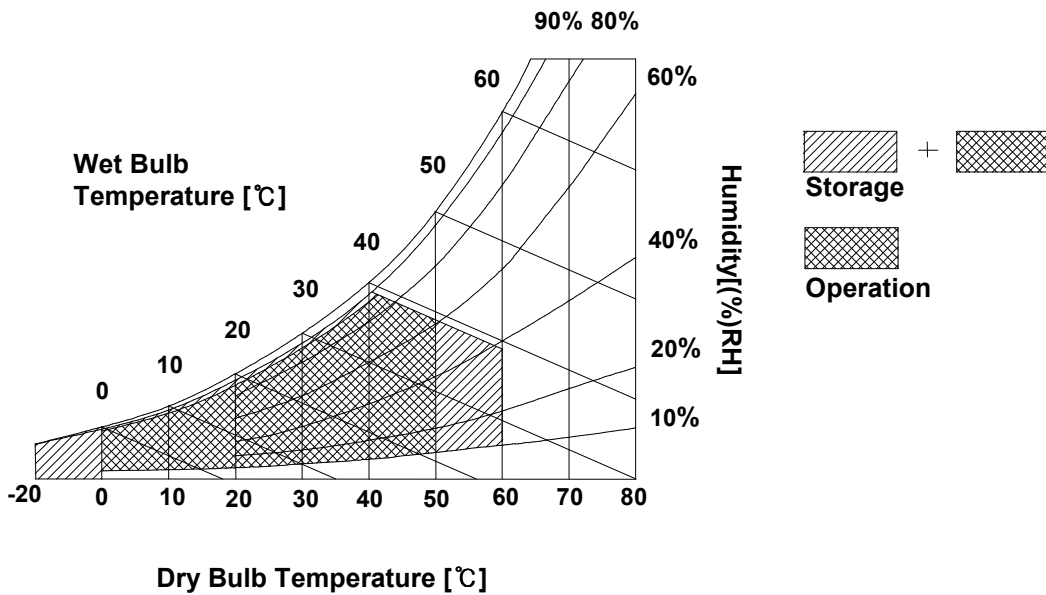

Product Specification

3. Electrical Specifications

3-1. Electrical Characteristics

The LP141WX3 requires two power inputs. One is employed to power the LCD electronics and to drive the TFT array and liquid crystal. The second input which powers the CCFL, is typically generated by an inverter. The inverter is an external unit to the LCD.

Table 2. ELECTRICAL CHARACTERISTICS

Parameter	Symbol	Values			Unit	Notes
		Min	Typ	Max		
MODULE :						
Power Supply Input Voltage	VCC	3.0	3.3	3.6	V _{DC}	
Power Supply Input Current	I _{CC} Mosaic	-	360	414	mA	1
Power Consumption	P _c Mosaic	-	1.2	1.4		
Differential Impedance	Z _m	90	100	110	Ohm	2
LAMP :						
Operating Voltage	V _{BL}	640(7.0mA)	670(6.0mA)	880(2.0mA)	V _{RMS}	
Operating Current	I _{BL}	2.0	6.0	7.0	mA _{RMS}	3
Power Consumption	P _{BL}	1.8	4.0	4.5	W	
Operating Frequency	f _{BL}	45	55	80	kHz	
Discharge Stabilization Time	T _s			3	Min	4
Life Time		15,000			Hrs	5
Established Starting Voltage at 25°C at 0 °C	V _s	1180			V _{RMS}	
		1415			V _{RMS}	

Note)

1. The specified current and power consumption are under the Vcc = 3.3V , 25°C , fv = 60Hz condition whereas Mosaic pattern is displayed and fv is the frame frequency.

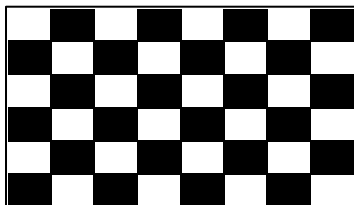

2. This impedance value is needed to proper display and measured form LVDS Tx to the mating connector.
3. The typical operating current is for the typical surface luminance (L_{WH}) in optical characteristics.
4. Define the brightness of the lamp after being lighted for 5 minutes as 100%, Ts is the time required for the brightness of the center of the lamp to be not less than 95%.
5. The life time is determined as the time at which brightness of lamp is 50% compare to that of initial value at the typical lamp current.

Product Specification

Note)

6. The output of the inverter must have symmetrical(negative and positive) voltage waveform and symmetrical current waveform.(Asymmetrical ratio is less than 10%) Please do not use the inverter which has asymmetrical voltage and asymmetrical current and spike wave.
Lamp frequency may produce interface with horizontal synchronous frequency and as a result this may cause beat on the display. Therefore lamp frequency shall be as away possible from the horizontal synchronous frequency and from its harmonics in order to prevent interference.
7. It is defined the brightness of the lamp after being lighted for 5 minutes as 100%.
 T_S is the time required for the brightness of the center of the lamp to be not less than 95%.
8. The lamp power consumption shown above does not include loss of external inverter.
The applied lamp current is a typical one.
9. Requirements for a system inverter design, which is intended to have a better display performance, a better power efficiency and a more reliable lamp, are following.
It shall help increase the lamp lifetime and reduce leakage current.
 - a. The asymmetry rate of the inverter waveform should be less than 10%.
 - b. The distortion rate of the waveform should be within $\sqrt{2} \pm 10\%$.
 * Inverter output waveform had better be more similar to ideal sine wave.

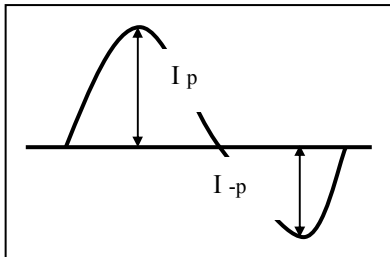

* Asymmetry rate:

$$\frac{|I_p - I_{-p}|}{I_{rms}} * 100\%$$

* Distortion rate

$$I_p \text{ (or } I_{-p}) / I_{rms}$$

10. Inverter open voltage must be more than lamp voltage for more than 1 second for start-up. Otherwise, the lamps may not be turned on.
※ Do not attach a conducting tape to lamp connecting wire.
If the lamp wire attach to a conducting tape, TFT-LCD Module has a low luminance and the inverter has abnormal action. Because leakage current is occurred between lamp wire and conducting tape.

Ex of current wave)

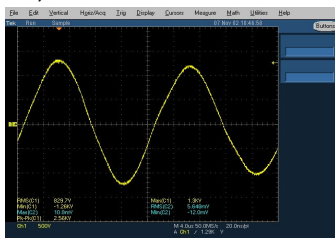

Normal current wave - Standard

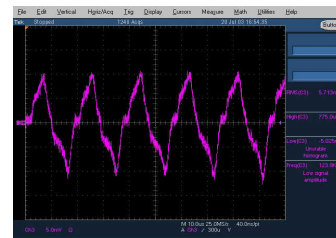

Abnormal current wave - Bad

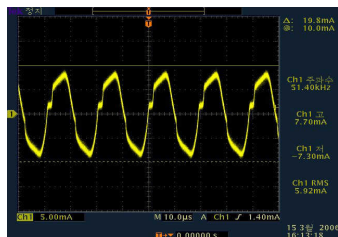

Abnormal current wave - Bad

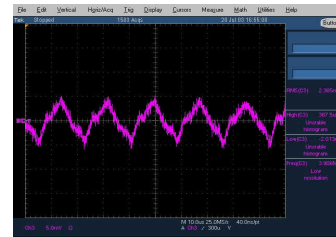

Abnormal current wave - Bad

Product Specification

3-2. Interface Connections

This LCD employs two interface connections, a 30 pin connector is used for the module electronics interface and the other connector is used for the integral backlight system.

The electronics interface connector is a model GT101-30S-HR11 manufactured by LSC.

Table 3. MODULE CONNECTOR PIN CONFIGURATION (CN1)

Pin	Symbol	Description	Notes
1	GND	Ground	1, Interface chips 1.1 LCD : SW, SW0612B (LCD Controller) including LVDS Receiver 1.2 System : THC63LVD823A or equivalent * Pin to Pin compatible with LVDS 2. Connector 2.1 LCD : GT101-30S-HR11, LSC IS100-C30R-C15 ,UJU Elec. it's compatible. 2.2 Mating : FI-X30M or equivalent. 2.3 Connector pin arrangement  [LCD Module Rear View]
2	VCC	Power Supply, 3.3V Typ.	
3	VCC	Power Supply, 3.3V Typ.	
4	V EEDID	DDC 3.3V power	
5	NC	Reserved for supplier test point	
6	Clk EEDID	DDC Clock	
7	DATA EEDID	DDC Data	
8	R _{IN} 0-	Negative LVDS differential data input	
9	R _{IN} 0+	Positive LVDS differential data input	
10	GND	Ground	
11	R _{IN} 1-	Negative LVDS differential data input	
12	R _{IN} 1+	Positive LVDS differential data input	
13	GND	Ground	
14	R _{IN} 2-	Negative LVDS differential data input	
15	R _{IN} 2+	Positive LVDS differential data input	
16	GND	Ground	
17	CLKIN-	Negative LVDS differential clock input	
18	CLKIN+	Positive LVDS differential clock input	
19	GND	Ground	
20	NC	No Connect	
21	NC	No Connect	
22	GND	Ground	
23	NC	No Connect	
24	NC	No Connect	
25	GND	Ground	
26	NC	No Connect	
27	NC	No Connect	
28	GND	Ground	
29	NC	No Connect	
30	NC	No Connect	

The backlight interface connector is a model BHSR-02VS-1, manufactured by JST or Compatible. The mating connector part number is AMP1674817-2 or equivalent.

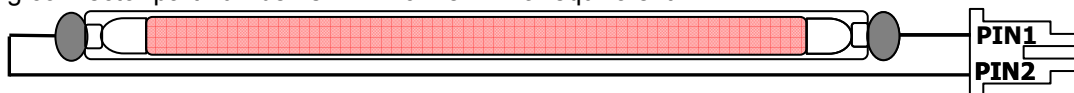

Table 4. BACKLIGHT CONNECTOR PIN CONFIGURATION (J3)

Pin	Symbol	Description	Notes
1	HV	Power supply for lamp (High voltage side)	1
2	LV	Power supply for lamp (Low voltage side)	1

Notes : 1. The high voltage side terminal is colored White and the low voltage side terminal is Yellow.

Product Specification

3-3. LVDS Signal Timing Specifications

3-3-1. DC Specification

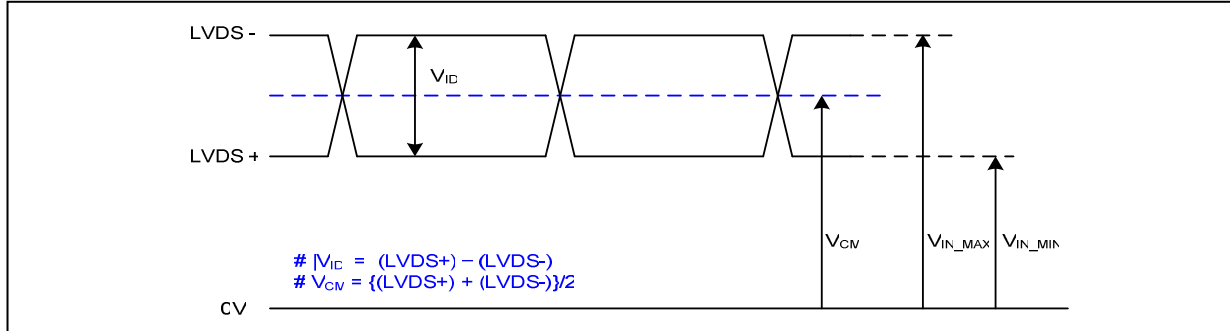

Description	Symbol	Min	Max	Unit	Notes
LVDS Differential Voltage	$ V_{ID} $	100	600	mV	-
LVDS Common mode Voltage	V_{CM}	0.6	1.8	V	-
LVDS Input Voltage Range	V_{IN}	0.3	2.1	V	-

3-3-2. AC Specification

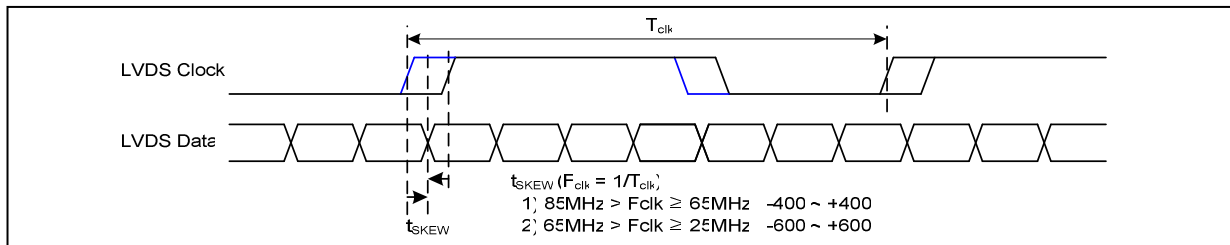

Description	Symbol	Min	Max	Unit	Notes
LVDS Clock to Data Skew Margin	t_{SKEW}	- 400	+ 400	ps	$85MHz > F_{clk} \geq 65MHz$
	t_{SKEW}	- 600	+ 600	ps	$65MHz > F_{clk} \geq 25MHz$
LVDS Clock to Clock Skew Margin (Even to Odd)	t_{SKEW_EO}	- 1/7	+ 1/7	T_{clk}	-
Maximum deviation of input clock frequency during SSC	F_{DEV}	-	± 3	%	-
Maximum modulation frequency of input clock during SSC	F_{MOD}	-	200	KHz	-

Product Specification

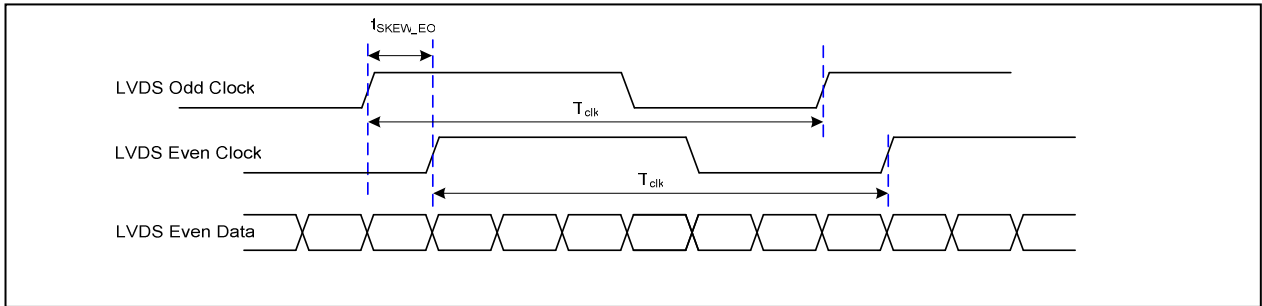

< Clock skew margin between channel >

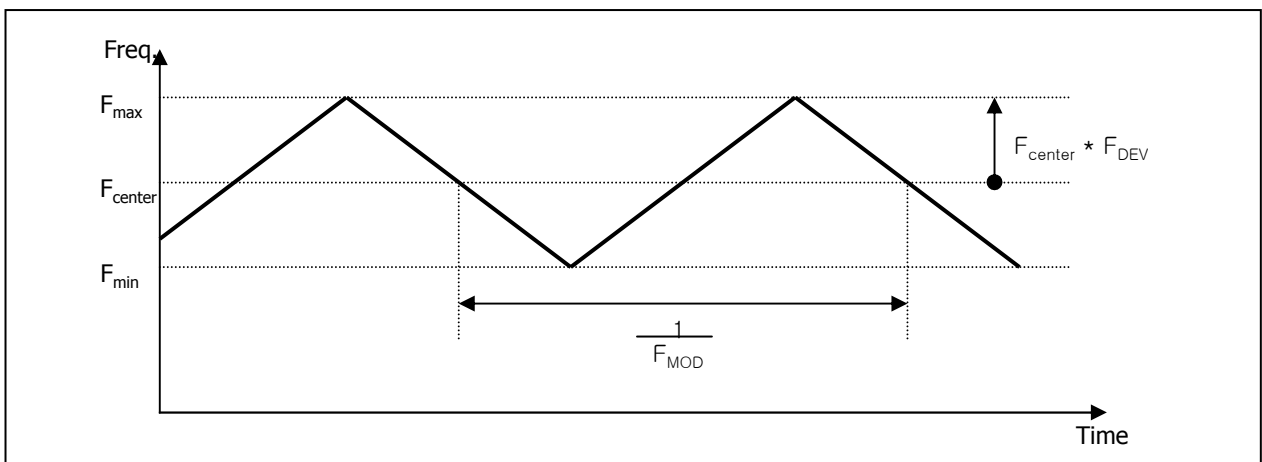

< Spread Spectrum >

3-3-3. Data Format

1) LVDS 1 Port

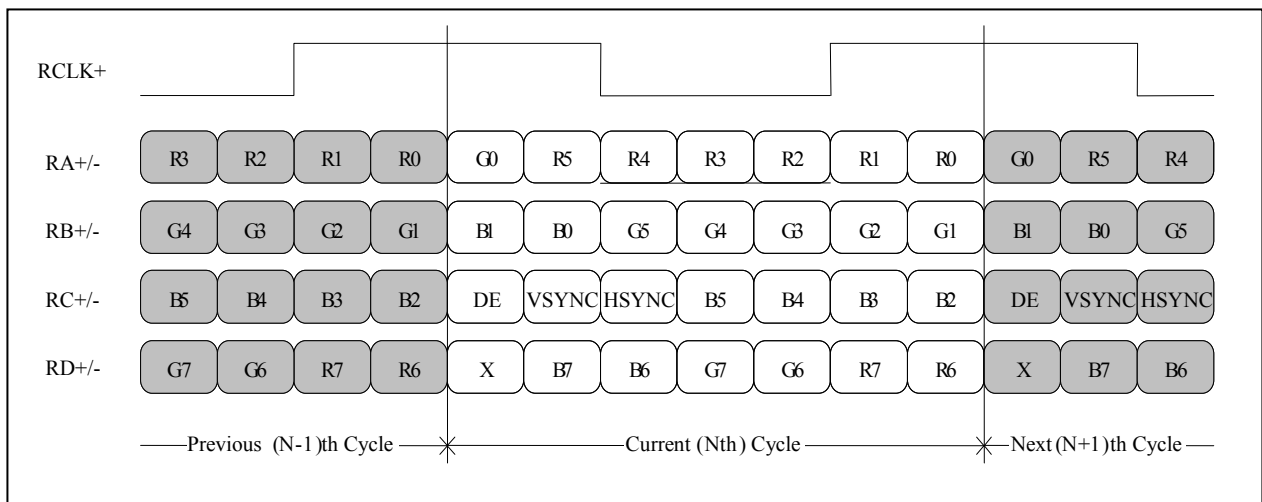

< LVDS Data Format >

3-4. Signal Timing Specifications

This is the signal timing required at the input of the User connector. All of the interface signal timing should be satisfied with the following specifications and specifications of LVDS Tx/Rx for its proper operation.

Table 6. TIMING TABLE

ITEM	Symbol	Min	Typ	Max	Unit	Note
DCLK	Frequency	f_{CLK}	-	69.3	-	MHz
Hsync	Period	T_{hp}	1360	1405	1480	tCLK
	Width	t_{WH}	16	32	48	
	Width-Active	t_{WHA}	1280	1280	1280	
Vsync	Period	t_{VP}	809	822	860	tHP
	Width	t_{WV}	2	6	10	
	Width-Active	t_{WVA}	800	800	800	
Data Enable	Horizontal back porch	t_{HBP}	40	45	96	tCLK
	Horizontal front porch	t_{HFP}	24	48	56	
	Vertical back porch	t_{VBP}	6	13	32	tHP
	Vertical front porch	t_{VFP}	1	3	18	

3-5. Signal Timing Waveforms

Condition : VCC = 3.3V

Data Enable, Hsync, Vsync

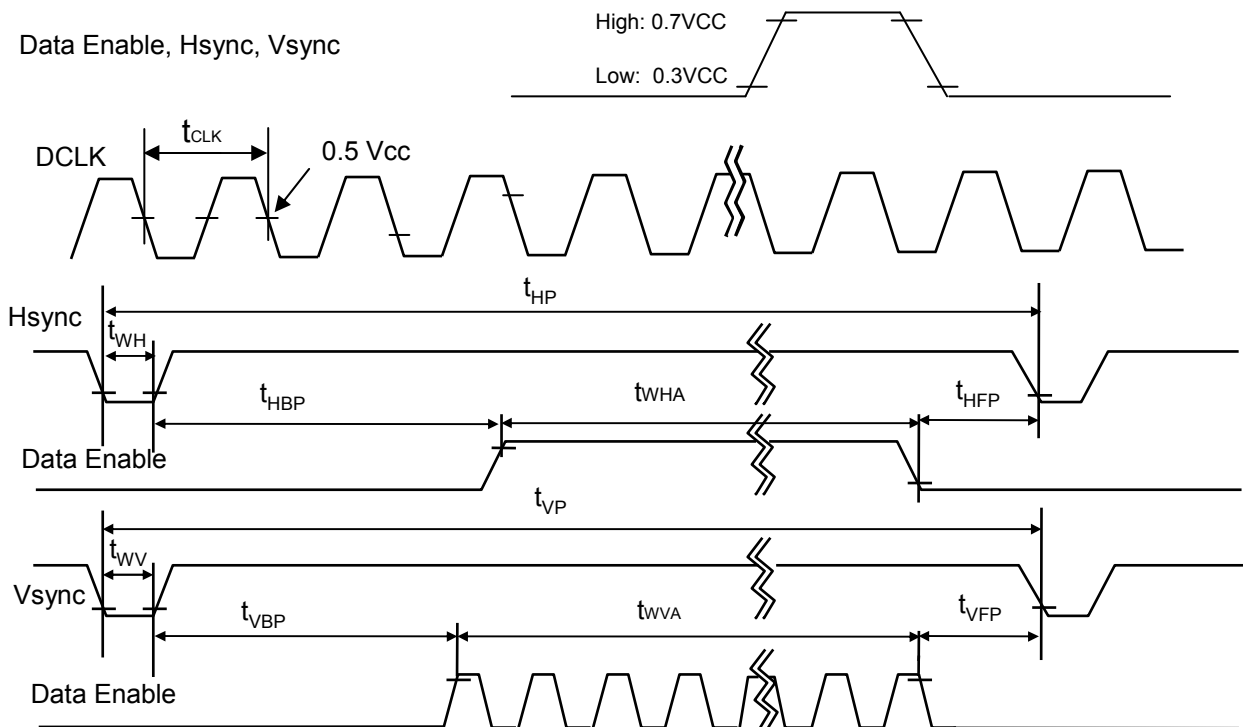

Product Specification

3-6. Color Input Data Reference

The brightness of each primary color (red, green and blue) is based on the 6-bit gray scale data input for the color ; the higher the binary input, the brighter the color. The table below provides a reference for color versus data input.

Table 7. COLOR DATA REFERENCE

Color		Input Color Data																	
		RED						GREEN						BLUE					
		MSB				LSB		MSB				LSB		MSB		LSB			
		R5	R4	R3	R2	R1	R0	G5	G4	G3	G2	G1	G0	B5	B4	B3	B2	B1	B0
Basic Color	Black	0	0	0	0	0	0	0	0	0	0	0	0	0	0	0	0	0	0
	Red	1	1	1	1	1	1	0	0	0	0	0	0	0	0	0	0	0	0
	Green	0	0	0	0	0	0	1	1	1	1	1	1	0	0	0	0	0	0
	Blue	0	0	0	0	0	0	0	0	0	0	0	0	1	1	1	1	1	1
	Cyan	0	0	0	0	0	0	1	1	1	1	1	1	1	1	1	1	1	1
	Magenta	1	1	1	1	1	1	0	0	0	0	0	0	1	1	1	1	1	1
	Yellow	1	1	1	1	1	1	1	1	1	1	1	1	0	0	0	0	0	0
	White	1	1	1	1	1	1	1	1	1	1	1	1	1	1	1	1	1	1
RED	RED (00)	0	0	0	0	0	0	0	0	0	0	0	0	0	0	0	0	0	0
	RED (01)	0	0	0	0	0	1	0	0	0	0	0	0	0	0	0	0	0	0
	...																		
	RED (62)	1	1	1	1	1	0	0	0	0	0	0	0	0	0	0	0	0	0
	RED (63)	1	1	1	1	1	1	0	0	0	0	0	0	0	0	0	0	0	0
GREEN	GREEN (00)	0	0	0	0	0	0	0	0	0	0	0	0	0	0	0	0	0	0
	GREEN (01)	0	0	0	0	0	0	0	0	0	0	0	1	0	0	0	0	0	0
	...																		
	GREEN (62)	0	0	0	0	0	0	1	1	1	1	1	0	0	0	0	0	0	0
	GREEN (63)	0	0	0	0	0	0	1	1	1	1	1	1	0	0	0	0	0	0
BLUE	BLUE (00)	0	0	0	0	0	0	0	0	0	0	0	0	0	0	0	0	0	0
	BLUE (01)	0	0	0	0	0	0	0	0	0	0	0	0	0	0	0	0	0	1
	...																		
	BLUE (62)	0	0	0	0	0	0	0	0	0	0	0	0	1	1	1	1	1	0
	BLUE (63)	0	0	0	0	0	0	0	0	0	0	0	0	1	1	1	1	1	1

Product Specification

3-7. Power Sequence

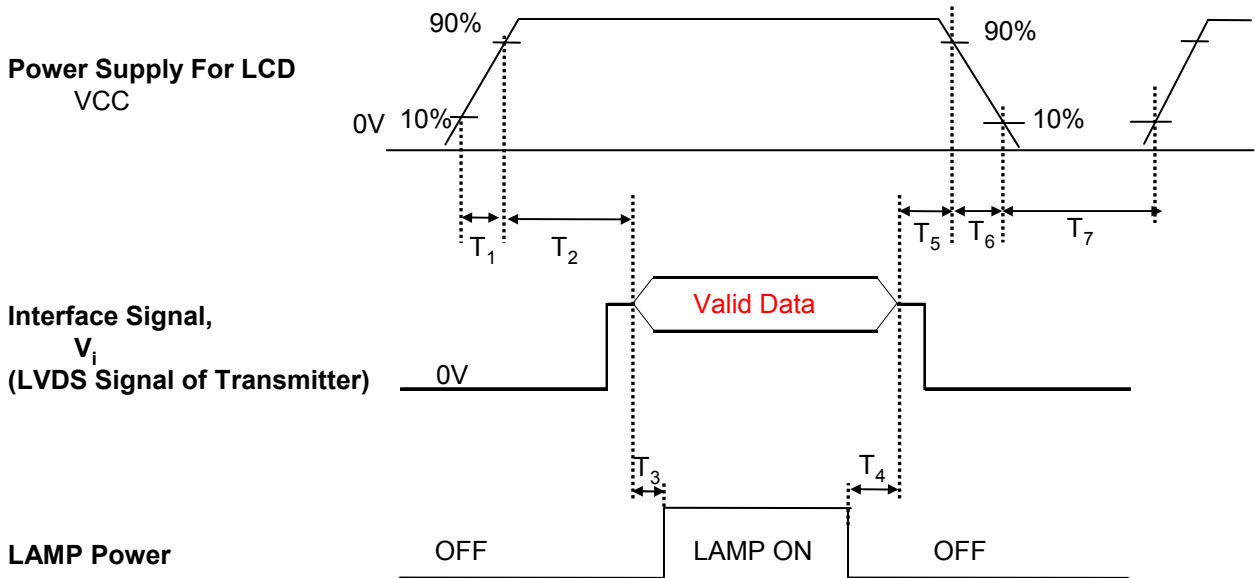

Table 8. POWER SEQUENCE TABLE

Parameter	Value			Units
	Min.	Typ.	Max.	
T_1	0.5	-	10	(ms)
T_2	0	-	50	(ms)
T_3	200	-	-	(ms)
T_4	200	-	-	(ms)
T_5	0	-	50	(ms)
T_6	0	-	10	(ms)
T_7	200	-	-	(ms)

Note)

1. Valid Data is Data to meet "3-3. LVDS Signal Timing Specifications"
2. Please avoid floating state of interface signal at invalid period.
3. When the interface signal is invalid, be sure to pull down the power supply for LCD VCC to 0V.
4. Lamp power must be turn on after power supply for LCD and interface signal are valid.

Product Specification

4. Optical Specification

Optical characteristics are determined after the unit has been 'ON' and stable for approximately 30 minutes in a dark environment at 25°C. The values specified are at an approximate distance 50cm from the LCD surface at a viewing angle of Φ and Θ equal to 0°.

FIG. 1 presents additional information concerning the measurement equipment and method.

FIG. 1 Optical Characteristic Measurement Equipment and Method

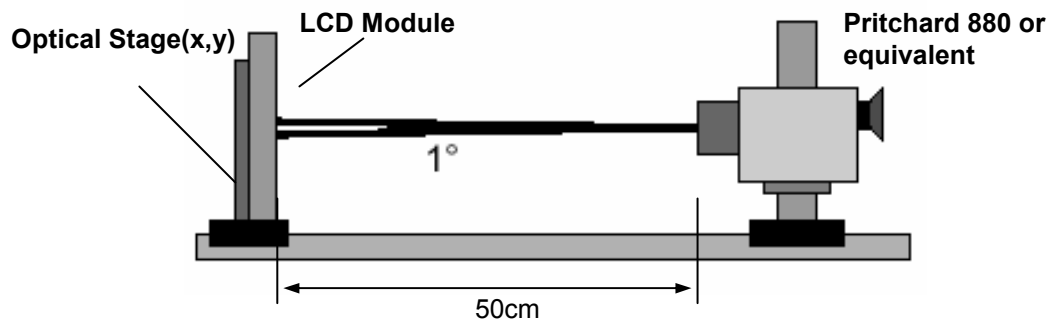

Table 9. OPTICAL CHARACTERISTICS

Ta=25°C, VCC=3.3V, fv=60Hz, f_{CLK}= 71.0MHz, F_{BL} = 55kHz , I_{BL}= 6.0mA

Parameter	Symbol	Values			Units	Notes
		Min	Typ	Max		
Contrast Ratio	CR	300	-	-		1
Surface Luminance, white	L _{WH}	170	200	-	cd/m ²	2
Luminance Variation	δ_{WHITE}	-	1.4	1.6		3
Response Time	T _R + T _D		16		ms	4
Color Coordinates						
RED	RX	0.554	0.584	0.614		
	RY	0.317	0.347	0.377		
GREEN	GX	0.294	0.324	0.354		
	GY	0.512	0.542	0.572		
BLUE	BX	0.128	0.158	0.188		
	BY	0.115	0.145	0.175		
WHITE	WX	0.283	0.313	0.343		
	WY	0.299	0.329	0.359		
Viewing Angle						
x axis, right($\Phi=0^\circ$)	Θ_r	40	-	-	degree	5
x axis, left ($\Phi=180^\circ$)	Θ_l	40	-	-	degree	
y axis, up ($\Phi=90^\circ$)	Θ_u	15	-	-	degree	
y axis, down ($\Phi=270^\circ$)	Θ_d	35	-	-	degree	
Gray Scale						6

Product Specification

Note)

1. Contrast Ratio(CR) is defined mathematically as

$$\text{Contrast Ratio} = \frac{\text{Surface Luminance with all white pixels}}{\text{Surface Luminance with all black pixels}}$$

2. Surface luminance is the average of 5 point across the LCD surface 50cm from the surface with all pixels displaying white. For more information see FIG 1.

$$L_{WH} = \text{Average}(L_1, L_2, \dots L_5)$$

3. The variation in surface luminance , The panel total variation (δ_{WHITE}) is determined by measuring L_N at each test position 1 through 13 and then defined as followed numerical formula.
For more information see FIG 2.

$$\delta_{WHITE} = \frac{\text{Maximum}(L_1, L_2, \dots L_{13})}{\text{Minimum}(L_1, L_2, \dots L_{13})}$$

4. Response time is the time required for the display to transition from white to black (rise time, Tr_R) and from black to white(Decay Time, Tr_D). For additional information see FIG 3.

5. Viewing angle is the angle at which the contrast ratio is greater than 10. The angles are determined for the horizontal or x axis and the vertical or y axis with respect to the z axis which is normal to the LCD surface. For more information see FIG 4.

6. Gray scale specification

* $f_v = 60\text{Hz}$

Gray Level	Luminance [%] (Typ)
L0	0.2
L7	1.96
L15	6.4
L23	12.6
L31	20.4
L39	34.9
L47	55.2
L55	78.8
L63	100

Product Specification

FIG. 2 Luminance

<measuring point for surface luminance & measuring point for luminance variation>

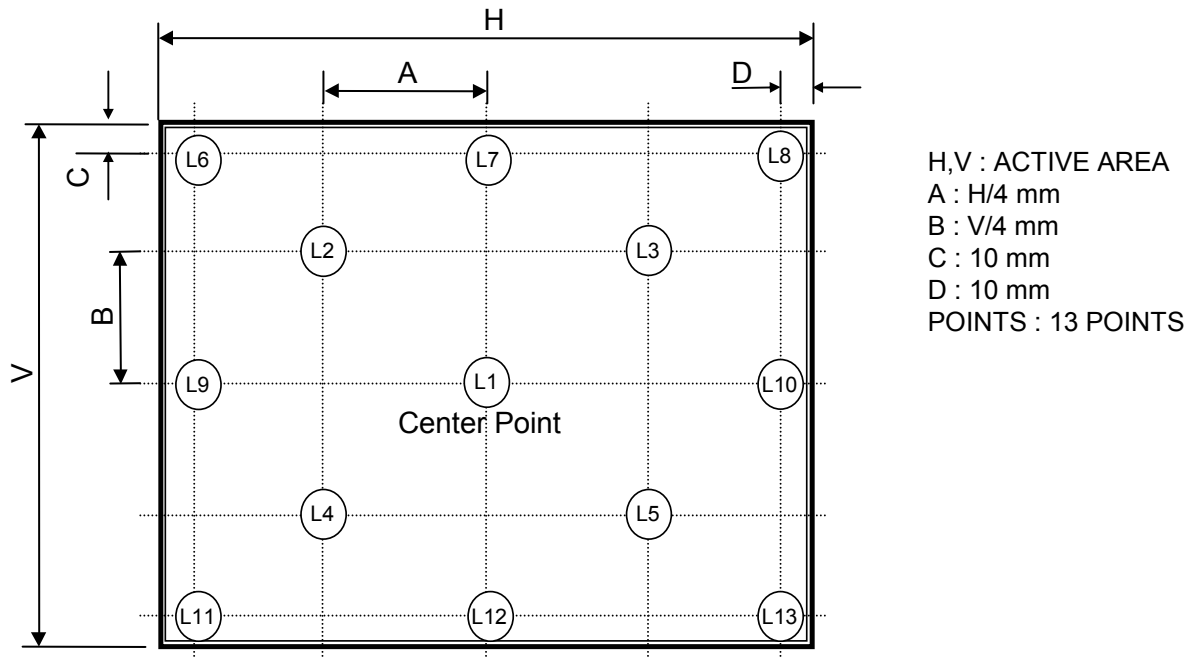
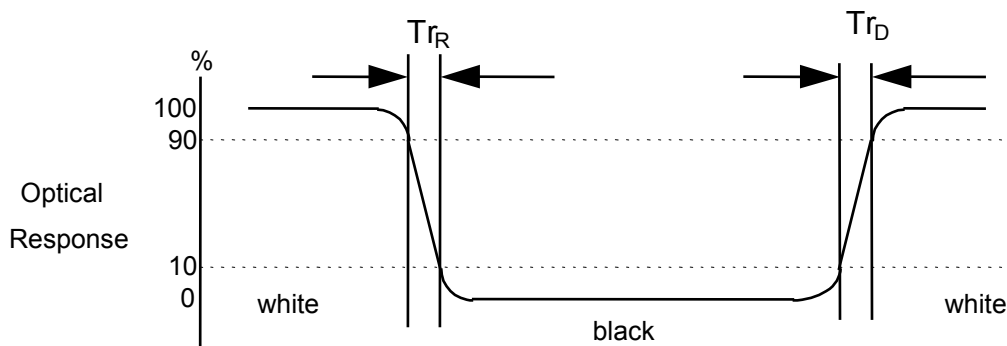

FIG. 3 Response Time

The response time is defined as the following figure and shall be measured by switching the input signal for “black” and “white”.



Product Specification

5. Mechanical Characteristics

The contents provide general mechanical characteristics for the model LP141WX3. In addition the figures in the next page are detailed mechanical drawing of the LCD.

Outline Dimension	Horizontal	319.5 ± 0.5mm
	Vertical	205.5 ± 0.5mm
	Thickness	5.5mm (max)
Bezel Area	Horizontal	306.76 ± 0.5mm
	Vertical	193.00 ± 0.5mm
Active Display Area	Horizontal	303.74 mm
	Vertical	189.84 mm
Weight	400(Max)	
Surface Treatment	Glare treatment of the front polarizer	

Product Specification

<FRONT VIEW>

Note) Unit:[mm], General tolerance: $\pm 0.5\text{mm}$

Wire Length : 61mm

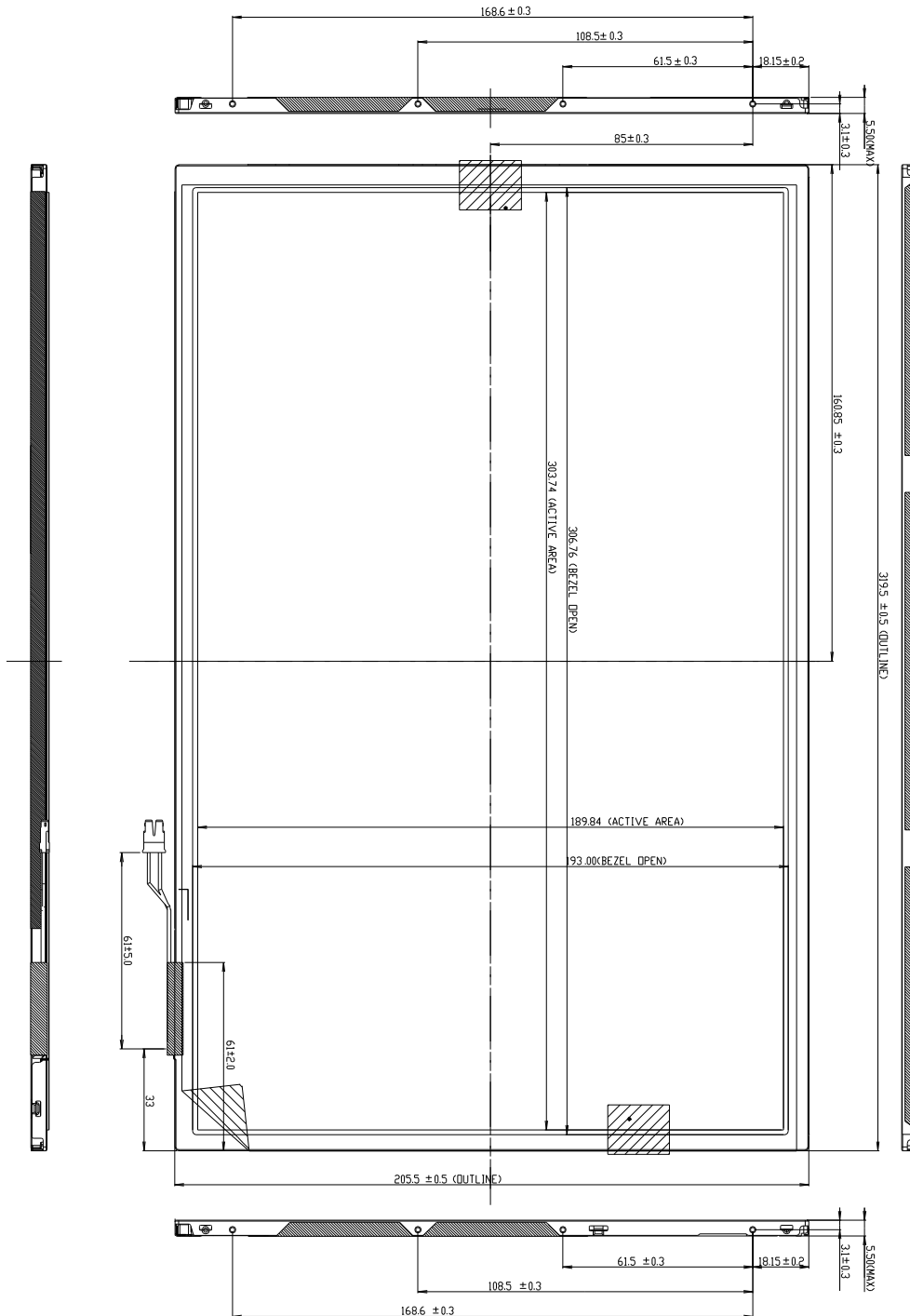

Product Specification

<REAR VIEW>

Note) Unit:[mm], General tolerance: $\pm 0.5\text{mm}$

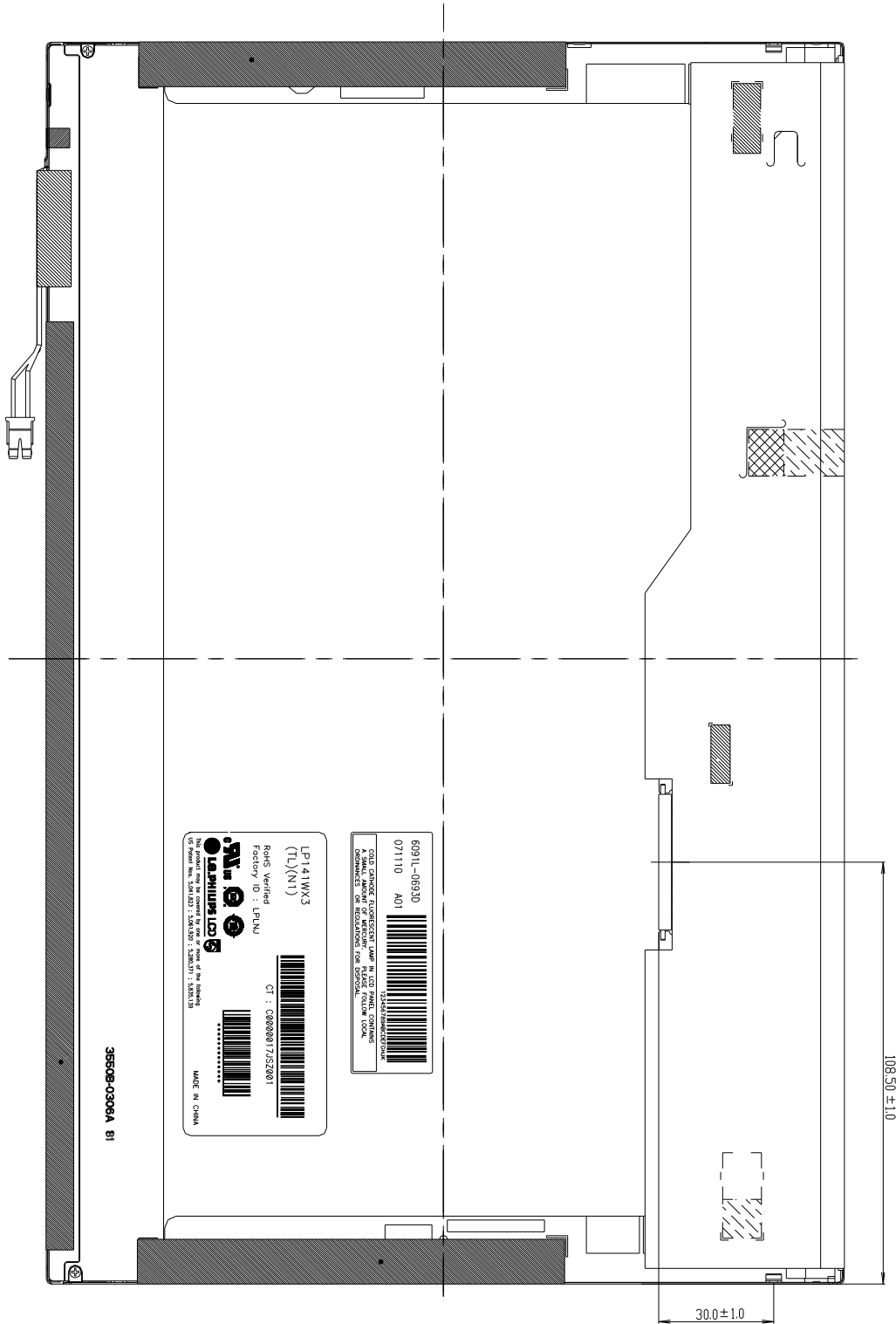

Product Specification

[DETAIL DESCRIPTION OF SIDE MOUNTING SCREW]

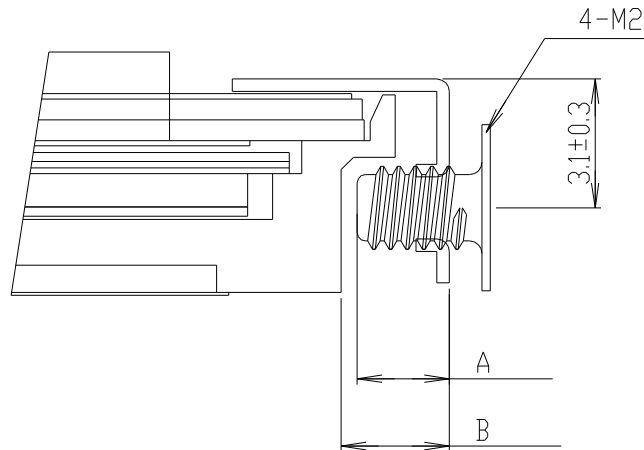

- * Mounting Screw Length (A)
= 2.0(Min) / 2.5(Max)
- * Mounting Screw Hole Depth (B)
= 2.5(Min)
- * Mounting hole location : 3.7(typ.)
- * Torque : 2.5 kgf.cm(Max)
(Measurement gauge : torque meter)

Notes : 1. Screw plated through the method of non-electrolytic nickel plating is preferred to reduce possibility that results in vertical and/or horizontal line defect due to the conductive particles from screw surface.

Product Specification

LPL Proposal for system cover design.(Appendix)

1	Gap check for securing the enough gap between LCM and System cover.	
<p>The diagram illustrates the assembly of the LCM and system cover. On the left, a color-coded view of the LCM reflector side is shown. In the center, a cross-sectional view shows the LCM with a 'Max thickness' dimension and a 'A boundary line' indicated by a red dashed line. On the right, a 'Sponge' is shown between the LCM and the 'System cover'.</p>		
Define	<p>1.Rear side of LCM is sensitive against external stress,and previous check about interference is highly needed.</p> <p>2.In case there is something from system cover comes into the boundary above,mechanical interference may cause the FOS defects. (Eg:Ripple,White spot..)</p>	
2	Check if antenna cable is sufficiently apart from T-CON of LCD Module.	
Define	<p>The diagram shows two scenarios for antenna cable placement on a laptop. The left scenario, labeled 'NO GOOD', shows the antenna cable overlapping the T-CON. The right scenario, labeled 'GOOD', shows the antenna cable placed away from the T-CON.</p>	
	1.If system antenna is overlapped with T-CON,it might be cause the noise.	

Product Specification

LPL Proposal for system cover design.

3	Gap check for securing the enough gap between LCM and System hinge.	
Define	<p>1. At least 2.0mm of gap needs to be secured to prevent the shock related defects.</p> <p>2. "L" type of hinge is recommended than "I" type under shock test.</p>	
4	Checking the path of the System wire.	
Define	<p>1. COF area needs to be handled with care.</p> <p>2. GOOD → Wire path design to system side. OK → Wire path is located between COFs. BAD → Wire path overlapped with COF area.</p>	

LPL Proposal for system cover design.

5	Using a bracket on the top of LCM is not recommended.	
---	---	--

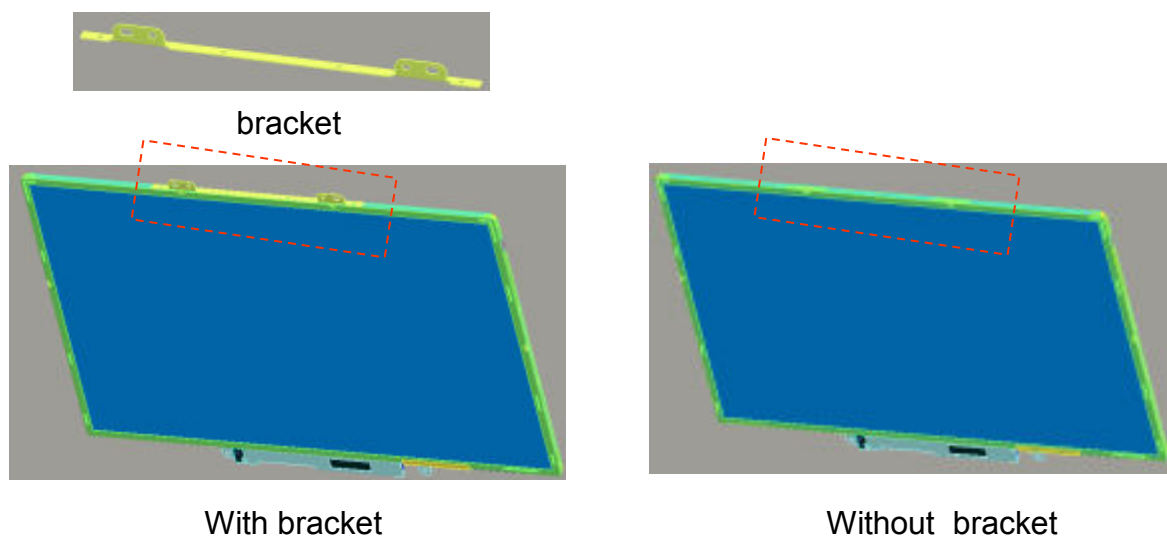

Define	<p>1.Condition without bracket is good for mechanical noise,and can minimize the light leakage from deformation of bracket.</p> <p>2.The results shows that there is no difference between the condition with or without bracket.</p>
--------	---

6	Securing additional gap on CNT area..	
---	---------------------------------------	--

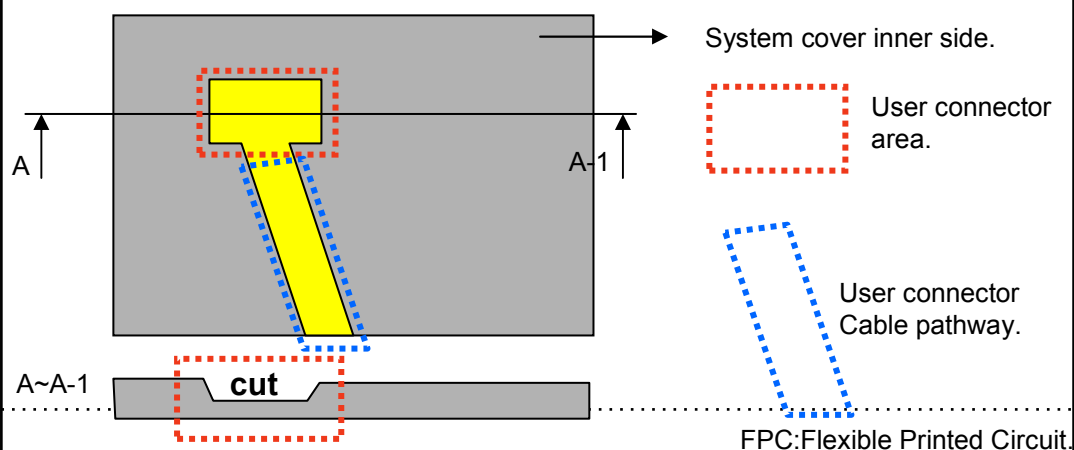

Define	<p>1.CNT area is specially sensitive against external stress,and additional gap by cutting on system cover will be helpful on removing the Ripple.</p> <p>2.Using a thinner CNT will be better. (eg: FPC type)</p>	
--------	--	--

Product Specification

6. Reliability

Environment test condition

No.	Test Item	Conditions
1	High temperature storage test	Ta= 60°C, 240h
2	Low temperature storage test	Ta= -20°C, 240h
3	High temperature operation test	Ta= 50°C, 50%RH, 240h
4	Low temperature operation test	Ta= 0°C, 240h
5	Vibration test (non-operating)	Sine wave, 10 ~ 500 ~ 10Hz, 1.5G, 0.37oct/min 3 axis, 1hour/axis
6	Shock test (non-operating)	Half sine wave, 180G, 2ms one shock of each six faces(I.e. run 180G, 2ms for all six faces)
7	Altitude operating storage / shipment	0 ~ 10,000 feet (3,048m) 24Hr 0 ~ 40,000 feet (12,192m) 24Hr

{ Result Evaluation Criteria }

There should be no change which might affect the practical display function when the display quality test is conducted under normal operating condition.

7. International Standards

7-1. Safety

- a) UL 60950-1:2003, First Edition, Underwriters Laboratories, Inc., Standard for Safety of Information Technology Equipment.
- b) CAN/CSA C22.2, No. 60950-1-03 1st Ed. April 1, 2003, Canadian Standards Association, Standard for Safety of Information Technology Equipment.
- c) EN 60950-1:2001, First Edition, European Committee for Electrotechnical Standardization(CENELEC) European Standard for Safety of Information Technology Equipment.

7-2. EMC

- a) ANSI C63.4 "Methods of Measurement of Radio-Noise Emissions from Low-Voltage Electrical and Electrical Equipment in the Range of 9kHz to 40GHz. "American National Standards Institute(ANSI), 1992
- b) C.I.S.P.R "Limits and Methods of Measurement of Radio Interface Characteristics of Information Technology Equipment." International Special Committee on Radio Interference.
- c) EN 55022 "Limits and Methods of Measurement of Radio Interface Characteristics of Information Technology Equipment." European Committee for Electrotechnical Standardization.(CENELEC), 1998 (Including A1: 2000)

Product Specification

8. Packing

8-1. Designation of Lot Mark

a) Lot Mark

A	B	C	D	E	F	G	H	I	J	K	L	M
---	---	---	---	---	---	---	---	---	---	---	---	---

A,B,C : SIZE(INCH)
E : MONTH

D : YEAR
F ~ M : SERIAL NO.

Note

1. YEAR

Year	2001	2002	2003	2004	2005	2006	2007	2008	2009	2010
Mark	1	2	3	4	5	6	7	8	9	0

2. MONTH

Month	Jan	Feb	Mar	Apr	May	Jun	Jul	Aug	Sep	Oct	Nov	Dec
Mark	1	2	3	4	5	6	7	8	9	A	B	C

b) Location of Lot Mark

Serial No. is printed on the label. The label is attached to the backside of the LCD module.
This is subject to change without prior notice.

8-2. Packing Form

a) Package quantity in one box : 20 pcs

b) Box Size : 430mm × 334mm × 287mm

9. PRECAUTIONS

Please pay attention to the followings when you use this TFT LCD module.

9-1. MOUNTING PRECAUTIONS

- (1) You must mount a module using holes arranged in four corners or four sides.
- (2) You should consider the mounting structure so that uneven force (ex. Twisted stress) is not applied to the module. And the case on which a module is mounted should have sufficient strength so that external force is not transmitted directly to the module.
- (3) Please attach the surface transparent protective plate to the surface in order to protect the polarizer. Transparent protective plate should have sufficient strength in order to resist external force.
- (4) You should adopt radiation structure to satisfy the temperature specification.
- (5) Acetic acid type and chlorine type materials for the cover case are not desirable because the former generates corrosive gas of attacking the polarizer at high temperature and the latter causes circuit break by electro-chemical reaction.
- (6) Do not touch, push or rub the exposed polarizers with glass, tweezers or anything harder than HB pencil lead. And please do not rub with dust clothes with chemical treatment. Do not touch the surface of polarizer for bare hand or greasy cloth. (Some cosmetics are detrimental to the polarizer.)
- (7) When the surface becomes dusty, please wipe gently with absorbent cotton or other soft materials like chamois soaks with petroleum benzene. Normal-hexane is recommended for cleaning the adhesives used to attach front / rear polarizers. Do not use acetone, toluene and alcohol because they cause chemical damage to the polarizer.
- (8) Wipe off saliva or water drops as soon as possible. Their long time contact with polarizer causes deformations and color fading.
- (9) Do not open the case because inside circuits do not have sufficient strength.

9-2. OPERATING PRECAUTIONS

- (1) The spike noise causes the mis-operation of circuits. It should be lower than following voltage :
 $V = \pm 200\text{mV}$ (Over and under shoot voltage)
- (2) Response time depends on the temperature. (In lower temperature, it becomes longer.)
- (3) Brightness depends on the temperature. (In lower temperature, it becomes lower.)
And in lower temperature, response time (required time that brightness is stable after turned on) becomes longer.
- (4) Be careful for condensation at sudden temperature change. Condensation makes damage to polarizer or electrical contacted parts. And after fading condensation, smear or spot will occur.
- (5) When fixed patterns are displayed for a long time, remnant image is likely to occur.
- (6) Module has high frequency circuits. Sufficient suppression to the electromagnetic interference shall be done by system manufacturers. Grounding and shielding methods may be important to minimize the interference.

9-3. ELECTROSTATIC DISCHARGE CONTROL

Since a module is composed of electronic circuits, it is not strong to electrostatic discharge. Make certain that treatment persons are connected to ground through wrist band etc. And don't touch interface pin directly.

9-4. PRECAUTIONS FOR STRONG LIGHT EXPOSURE

Strong light exposure causes degradation of polarizer and color filter.

9-5. STORAGE

When storing modules as spares for a long time, the following precautions are necessary.

- (1) Store them in a dark place. Do not expose the module to sunlight or fluorescent light. Keep the temperature between 5°C and 35°C at normal humidity.
- (2) The polarizer surface should not come in contact with any other object.
It is recommended that they be stored in the container in which they were shipped.

9-6. HANDLING PRECAUTIONS FOR PROTECTION FILM

- (1) When the protection film is peeled off, static electricity is generated between the film and polarizer.
This should be peeled off slowly and carefully by people who are electrically grounded and with well ion-blown equipment or in such a condition, etc.
- (2) The protection film is attached to the polarizer with a small amount of glue. If some stress is applied to rub the protection film against the polarizer during the time you peel off the film, the glue is apt to remain on the polarizer.
Please carefully peel off the protection film without rubbing it against the polarizer.
- (3) When the module with protection film attached is stored for a long time, sometimes there remains a very small amount of glue still on the polarizer after the protection film is peeled off.
- (4) You can remove the glue easily. When the glue remains on the polarizer surface or its vestige is recognized, please wipe them off with absorbent cotton waste or other soft material like chamois soaked with normal-hexane.

Product Specification

APPENDIX A. Enhanced Extended Display Identification Data (EEDID™) 1/3

Byte# (decimal)	Byte# (HEX)	Field Name and Comments	Value (HEX)	Value (binary)	
0	00	Header	0 0	0000 0000	Header
1	01	Header	F F	1111 1111	
2	02	Header	F F	1111 1111	
3	03	Header	F F	1111 1111	
4	04	Header	F F	1111 1111	
5	05	Header	F F	1111 1111	
6	06	Header	F F	1111 1111	
7	07	Header	0 0	0000 0000	
8	08	EISA manufacturer code = LPL	3 2	0011 0010	Vender/ Product ID
9	09	Compressed ASCII	0 C	0000 1100	
10	0A	Product code =	2 9	0010 1001	
11	0B	(Hex, LSB first)	0 1	0000 0001	
12	0C	LCD Module Serial No. = 0 (If not used)	0 0	0000 0000	
13	0D	LCD Module Serial No. = 0 (If not used)	0 0	0000 0000	
14	0E	LCD Module Serial No. = 0 (If not used)	0 0	0000 0000	
15	0F	LCD Module Serial No. = 0 (If not used)	0 0	0000 0000	
16	10	Week of manufacture	0 0	0000 0000	
17	11	Year of manufacture = 2007	1 1	0001 0001	
18	12	EDID Structure version # = 1	0 1	0000 0001	EDID Version/ Revision
19	13	EDID Revision # = 3	0 3	0000 0011	
20	14	Video input definition = Digital I/p,non TMDS CRGB	8 0	1000 0000	Display Parameter
21	15	Max H image size(cm) = 30.374cm (30)	1 E	0001 1110	
22	16	Max V image size(cm) = 18.984cm (19)	1 3	0001 0011	
23	17	Display gamma = 2.20	7 8	0111 1000	
24	18	Feature support(DPMS) = Active off, RGB Color	0 A	0000 1010	
25	19	Red/Green low Bits	B 3	1011 0011	Color Characteristic
26	1A	Blue/White Low Bits	8 5	1000 0101	
27	1B	Red X Rx = 0.584	9 5	1001 0101	
28	1C	Red Y Ry = 0.347	5 8	0101 1000	
29	1D	Green X Gx = 0.324	5 3	0101 0011	
30	1E	Green Y Gy = 0.542	8 A	1000 1010	
31	1F	Blue X Bx = 0.158	2 8	0010 1000	
32	20	Blue Y By = 0.145	2 5	0010 0101	
33	21	White X Wx = 0.313	5 0	0101 0000	
34	22	White Y Wy = 0.329	5 4	0101 0100	
35	23	Established Timing I	0 0	0000 0000	Established Timings
36	24	Established Timing II	0 0	0000 0000	
37	25	Manufacturer's Timings	0 0	0000 0000	Standard Timing ID
38	26	Standard Timing Identification 1 was not used	0 1	0000 0001	
39	27	Standard Timing Identification 1 was not used	0 1	0000 0001	
40	28	Standard Timing Identification 2 was not used	0 1	0000 0001	
41	29	Standard Timing Identification 2 was not used	0 1	0000 0001	
42	2A	Standard Timing Identification 3 was not used	0 1	0000 0001	
43	2B	Standard Timing Identification 3 was not used	0 1	0000 0001	
44	2C	Standard Timing Identification 4 was not used	0 1	0000 0001	
45	2D	Standard Timing Identification 4 was not used	0 1	0000 0001	
46	2E	Standard Timing Identification 5 was not used	0 1	0000 0001	
47	2F	Standard Timing Identification 5 was not used	0 1	0000 0001	
48	30	Standard Timing Identification 6 was not used	0 1	0000 0001	
49	31	Standard Timing Identification 6 was not used	0 1	0000 0001	
50	32	Standard Timing Identification 7 was not used	0 1	0000 0001	
51	33	Standard Timing Identification 7 was not used	0 1	0000 0001	
52	34	Standard Timing Identification 8 was not used	0 1	0000 0001	
53	35	Standard Timing Identification 8 was not used	0 1	0000 0001	

Product Specification

APPENDIX A. Enhanced Extended Display Identification Data (EEDID™) 2/3

Byte# (decimal)	Byte# (HEX)	Field Name and Comments	Value (HEX)	Value (binary)		
54	36	Pixel Clock/10,000 (LSB) 69.3 MHz @60 Hz	1 2	0001 0010	Detailed Timing Descriptor #1	
55	37	Pixel Clock/10,000 (MSB)	1 B	0001 1011		
56	38	Horizontal Active 1280 pixels	0 0	0000 0000		
57	39	Horizontal Blanking(Thbp) 125 pixels	7 D	0111 1101		
58	3A	Horizontal Active / Horizontal Blanking(Thbp)	5 0	0101 0000		
59	3B	Vertical Avtive 800 lines	2 0	0010 0000		
60	3C	Vertical Blanking (Tvbp) 22 lines	1 6	0001 0110		
61	3D	Vertical Active : Vertical Blanking (Tvbp)	3 0	0011 0000		
62	3E	Horizontal Sync. Offset (Thfp) 48 pixels	3 0	0011 0000		
63	3F	Horizontal Sync Pulse Width 32 pixels	2 0	0010 0000		
64	40	Vertical Sync Offset(Tvbp) : Sync Width 3 lines : 6 lines	3 6	0011 0110		
65	41	Horizontal Vertical Sync Offset/Width upper 2bits	0 0	0000 0000		
66	42	Horizontal Image Size 304 mm	3 0	0011 0000		
67	43	Vertical Image Size 190 mm	B E	1011 1110		
68	44	Horizontal Image Size / Vertical Image Size	1 0	0001 0000		
69	45	Horizontal Border = 0 (Zero for Notebook LCD)	0 0	0000 0000		
70	46	Vertical Border = 0 (Zero for Notebook LCD)	0 0	0000 0000		
71	47	Non-interlaced, Normal ,no stereo, separate sync, H/V pol negatives, DE only note : LSB is set to "1" if panel is DE-timing only. H/V can be ignored.	1 8	0001 1000		
72	48	Detailed Timing Descriptor #2	0 0	0000 0000		Detailed Timing Description #2
73	49		0 0	0000 0000		
74	4A		0 0	0000 0000		
75	4B		0 0	0000 0000		
76	4C		0 0	0000 0000		
77	4D		0 0	0000 0000		
78	4E		0 0	0000 0000		
79	4F		0 0	0000 0000		
80	50		0 0	0000 0000		
81	51		0 0	0000 0000		
82	52		0 0	0000 0000		
83	53		0 0	0000 0000		
84	55		0 0	0000 0000		
85	55		0 0	0000 0000		
86	56		0 0	0000 0000		
87	57		0 0	0000 0000		
88	58		0 0	0000 0000		
89	59		0 0	0000 0000		
90	5A	Detailed Timing Descriptor #3	0 0	0000 0000	Detailed Timing Description #3	
91	5B		0 0	0000 0000		
92	5C		0 0	0000 0000		
93	5D		F E	1111 1110		
94	5E		0 0	0000 0000		
95	5F	L	4 C	0100 1100		
96	60	G	4 7	0100 0111		
97	61	P	5 0	0101 0000		
98	62	h	6 8	0110 1000		
99	63	i	6 9	0110 1001		
100	64	l	6 C	0110 1100		
101	65	i	6 9	0110 1001		
102	66	p	7 0	0111 0000		
103	67	s	7 3	0111 0011		
104	68	L	4 C	0100 1100		
105	69	C	4 3	0100 0011		
106	6A	D	4 4	0100 0100		
107	6B	LF	0 A	0000 1010		

Product Specification

APPENDIX A. Enhanced Extended Display Identification Data (EEDID™) 3/3

Byte# (decimal)	Byte# (HEX)	Field Name and Comments	Value (HEX)	Value (binary)	
108	6C	Detailed Timing Descriptor #4	0 0	0000 0000	Detailed Timing Description #4
109	6D		0 0	0000 0000	
110	6E		0 0	0000 0000	
111	6F		F E	1111 1110	
112	70		0 0	0000 0000	
113	71	L	4 C	0100 1100	
114	72	P	5 0	0101 0000	
115	73	1	3 1	0011 0001	
116	74	4	3 4	0011 0100	
117	75	1	3 1	0011 0001	
118	76	W	5 7	0101 0111	
119	77	X	5 8	0101 1000	
120	78	3	3 3	0011 0011	
121	79	-	2 D	0010 1101	
122	7A	T	5 4	0101 0100	
123	7B	L	4 C	0100 1100	
124	7C	N	4 E	0100 1110	
125	7D	1	3 1	0011 0001	
126	7E	Extension flag = 00	0 0	0000 0000	Extension Flag
127	7F	Checksum	B 2	1011 0010	Checksum