

LP2980-ADJ

Micropower SOT, 50 mA Ultra Low-Dropout Adjustable Voltage Regulator

General Description

The LP2980-ADJ is a 50 mA adjustable voltage regulator designed to provide ultra low dropout in battery powered applications.

Using an optimized VIP™ (vertically Integrated PNP) process, the LP2980-ADJ delivers unequalled performance in all specifications critical to battery-powered designs:

Adjustable Output: output voltage can be set from 1.23V to 15V.

Precision Reference: 0.75% tolerance.

Dropout Voltage: typically 120 mV @ 50 mA load, and 7 mV @ 1 mA load.

Ground Pin Current: typically 320 μ A @ 50 mA load, and 80 μ A @ 1 mA load.

Sleep Mode: less than 1 μ A quiescent current when on/off pin is pulled low.

Smallest Possible Size: SOT-23 package uses minimum board space.

Features

- Ultra low dropout voltage
- Output adjusts from 1.23V to 15V
- Guaranteed 50 mA output current
- Uses tiny SOT-23 package
- Requires few external components
- <1 μ A quiescent current when shutdown
- Low ground pin current at all loads
- High peak current capability (150 mA typical)
- Wide supply voltage range (2.5V–16V)
- Overtemperature/overcurrent protection
- -40°C to $+125^{\circ}\text{C}$ Junction temperature range

Applications

- Cellular Phone
- Palmtop/Laptop Computer
- Camcorder, Personal Stereo, Camera

Block Diagram

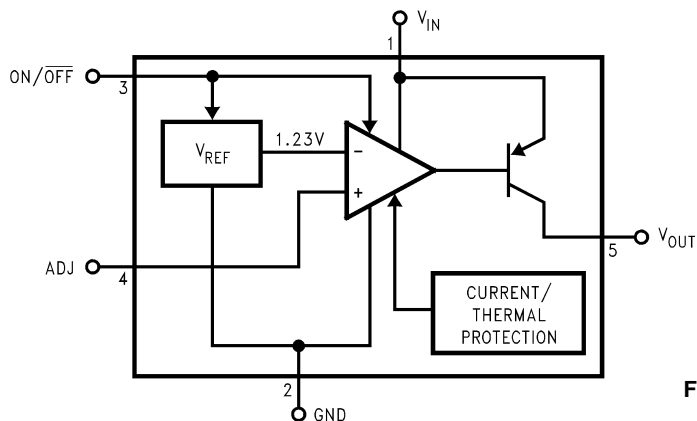

DS100001-1

Connection Diagram

5-Lead Small Outline Package (M5)

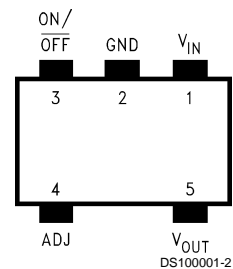

Top View

See NS Package Number MA05B
For ordering information, refer to Table 1 in this document

Basic Application Circuit

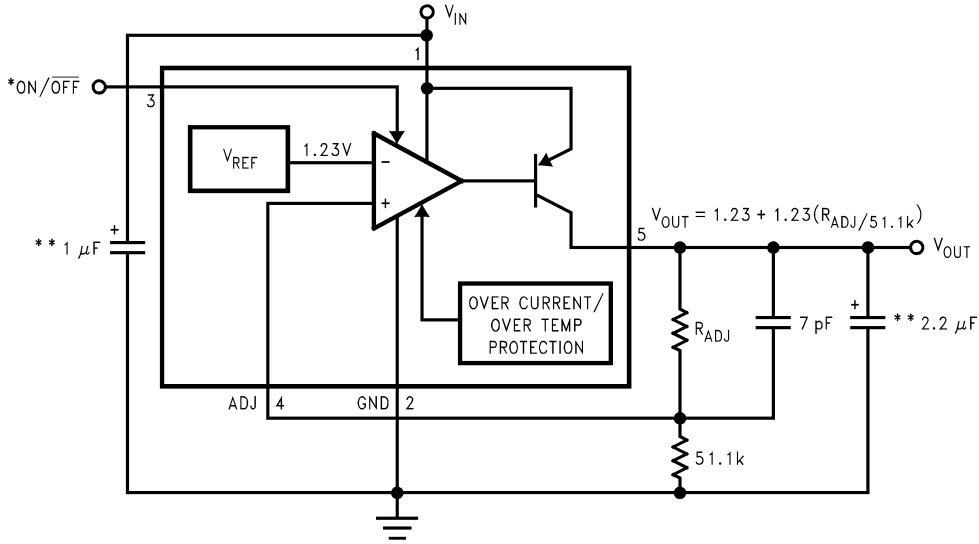

DS100001-3

*ON/OFF INPUT MUST BE ACTIVELY TERMINATED. TIE TO V_{IN} IF THIS FUNCTION IS NOT TO BE USED.

**MINIMUM CAPACITANCE IS SHOWN TO ENSURE STABILITY OVER FULL LOAD CURRENT RANGE (SEE APPLICATION HINTS).

Ordering Information

TABLE 1. Package Marking and Ordering Information

Grade	Order Information	Package Marking	Supplied as
STD	LP2980IM5X-ADJ	L06B	3k Units on Tape and Reel
STD	LP2980IM5-ADJ	L06B	250 Units on Tape and Reel

For fixed output voltage versions, see LP2980 and LP2980LV datasheets.

Absolute Maximum Ratings (Note 1)

If Military/Aerospace specified devices are required, please contact the National Semiconductor Sales Office/Distributors for availability and specifications.

Storage Temperature Range	-65 to +150°C	Input Supply Voltage (Operating)	2.5V to +16V
Operating Junction Temperature Range	-40 to +125°C	Shutdown Input Voltage (Survival)	-0.3V to +16V
Lead Temp. (Soldering, 5 seconds)	260°C	Output Voltage (Survival) (Note 4)	-0.3V to 16V
ESD Rating (Note 2)	2 kV	I _{OUT} (Survival)	Short Circuit Protected
Power Dissipation (Note 3)	Internally Limited	Input-Output Voltage (Survival) (Note 5)	-0.3V to 16V
Input Supply Voltage (Survival)	-0.3V to +16V		

Electrical Characteristics

Limits in standard typeface are for T_J = 25°C, and limits in **boldface type** apply over the full operating temperature range. Unless otherwise specified: V_{IN} = 4.3V, V_{OUT} = 3.3V, I_L = 1 mA, C_{IN} = 1 μF, C_{OUT} = 2.2 μF, V_{ON/OFF} = 2V.

Symbol	Parameter	Conditions	Typ	LP2980-ADJ (Note 6)		Units
				Min	Max	
V _{REF}	Reference Voltage		1.225	1.213	1.237	V
		1 mA < I _L < 50 mA V _{OUT} + 1 ≤ V _{IN} ≤ 16V	1.225	1.206	1.243	
$\frac{\Delta V_{REF}}{\Delta V_{IN}}$	Reference Voltage Line Regulation	2.5V ≤ V _{IN} ≤ 16V	3		6.0 15.0	mV
V _{IN} -V _O	Dropout Voltage (Note 7)	I _L = 0	1		3 5	mV
		I _L = 1 mA	7		10 15	
		I _L = 10 mA	40		60 90	
		I _L = 50 mA	120		150 225	
I _{GND}	Ground Pin Current	I _L = 0	60		95 125	μA
		I _L = 1 mA	80		110 170	
		I _L = 10 mA	120		220 460	
		I _L = 50 mA	320		600 1200	
		V _{ON/OFF} < 0.18V	0.01		1	
I _{ADJ}	ADJ Pin Bias Current	1 mA ≤ I _L ≤ 50 mA	150		350	nA
V _{ON/OFF}	ON/OFF Input Voltage (Note 8)	High = O/P ON	1.4	1.6		V
		Low = O/P OFF	0.55		0.18	
I _{ON/OFF}	ON/OFF Input Current	V _{ON/OFF} = 0	0.01		-1	μA
		V _{ON/OFF} = 5V	5		15	
I _O (PK)	Peak Output Current	V _{OUT} ≥ V _O (NOM) - 5%	150	100		mA
e _n	Output Noise Voltage (RMS)	BW = 300 Hz to 50 kHz, C _{OUT} = 10 μF	160			μV
$\frac{\Delta V_{OUT}}{\Delta V_{IN}}$	Ripple Rejection	f = 1 kHz C _{OUT} = 10 μF	68			dB
I _O (MAX)	Short Circuit Current	R _L = 0 (Steady State) (Note 9)	150			mA

Electrical Characteristics (Continued)

Note 1: Absolute maximum ratings indicate limits beyond which damage to the component may occur. Electrical specifications do not apply when operating the device outside of its rated operating conditions.

Note 2: The ESD rating of pins 3 and 4 is 1 kV.

Note 3: The maximum allowable power dissipation is a function of the maximum junction temperature, $T_J(\text{MAX})$, the junction-to-ambient thermal resistance, θ_{J-A} , and the ambient temperature, T_A . The maximum allowable power dissipation at any ambient temperature is calculated using:

$$P(\text{MAX}) = \frac{T_J(\text{MAX}) - T_A}{\theta_{J-A}}$$

The value of θ_{J-A} for the SOT-23 package is 300°C/W. Exceeding the maximum allowable power dissipation will cause excessive die temperature, and the regulator will go into thermal shutdown.

Note 4: If used in a dual-supply system where the regulator load is returned to a negative supply, the LP2980-ADJ output must be diode-clamped to ground.

Note 5: The output PNP structure contains a diode between the V_{IN} and V_{OUT} terminals that is normally reverse-biased. Reversing the polarity from V_{IN} to V_{OUT} will turn on this diode (see Application Hints).

Note 6: Limits are 100% production tested at 25°C. Limits over the operating temperature range are guaranteed through correlation using Statistical Quality Control (SQC) methods. The limits are used to calculate National's Average Outgoing Quality Level (AOQL).

Note 7: Dropout voltage is defined as the input to output differential at which the output voltage drops 100 mV below the value measured with a 1V differential.

Note 8: The ON/OFF input must be properly driven to prevent possible misoperation. For details, refer to Application Hints.

Note 9: See Typical Performance Characteristics curves.

Typical Performance Characteristics Unless otherwise specified: $T_A = 25^\circ\text{C}$, $V_{IN} = V_O(\text{NOM}) + 1\text{V}$, $I_L = 1\text{ mA}$, ON/OFF pin tied to V_{IN} , $R_{ADJ} = 86.6\text{ k}\Omega$, and test circuit is as shown in Basic Application Circuit.

Output Voltage vs. Temperature

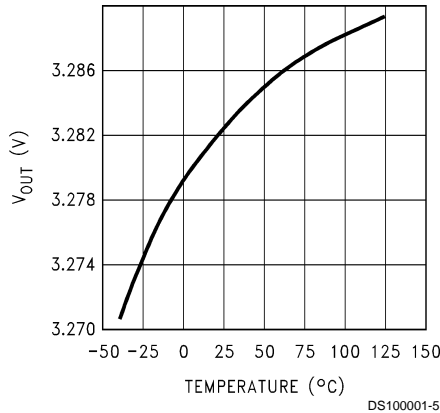

Dropout Characteristics

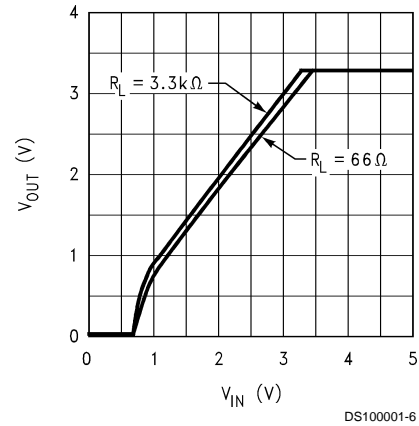

Dropout Voltage vs. Temperature

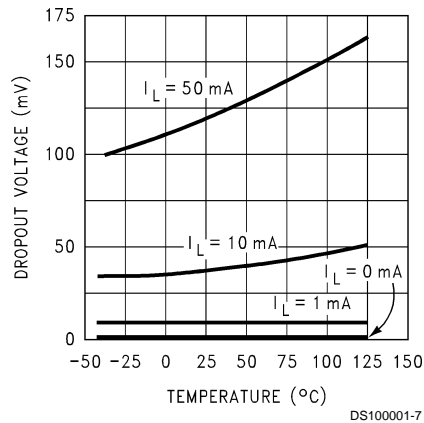

Dropout Voltage vs. Load Current

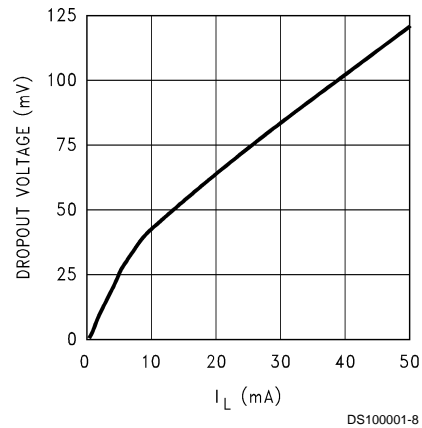

Typical Performance Characteristics

Unless otherwise specified: $T_A = 25^\circ\text{C}$, $V_{IN} = V_O(\text{NOM}) + 1\text{V}$, $I_L = 1\text{ mA}$, ON/OFF pin tied to V_{IN} , $R_{ADJ} = 86.6\text{k}$, and test circuit is as shown in Basic Application Circuit. (Continued)

Ground Pin Current vs. Temperature

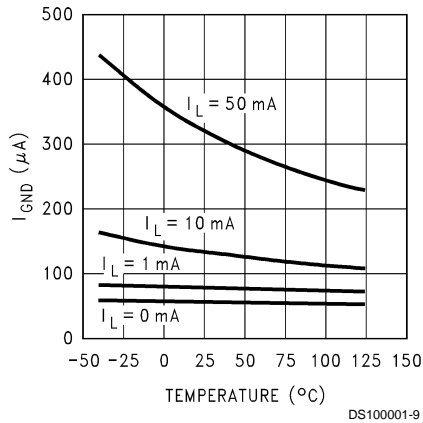

Ground Pin Current vs. Load Current

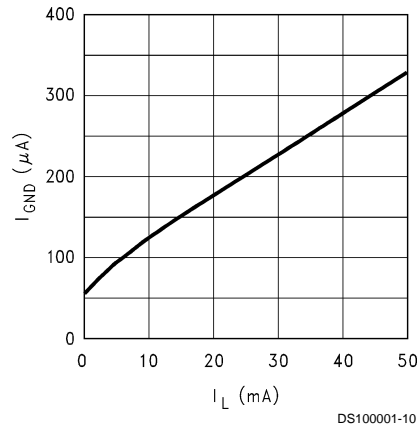

Input Current vs. V_{IN}

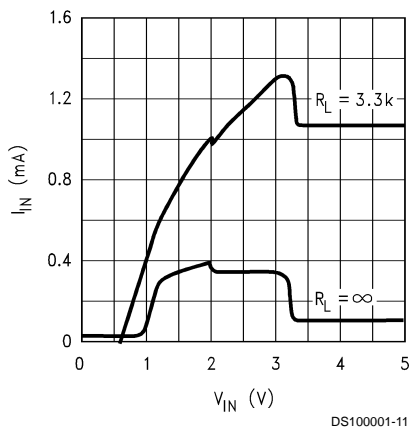

Load Transient Response

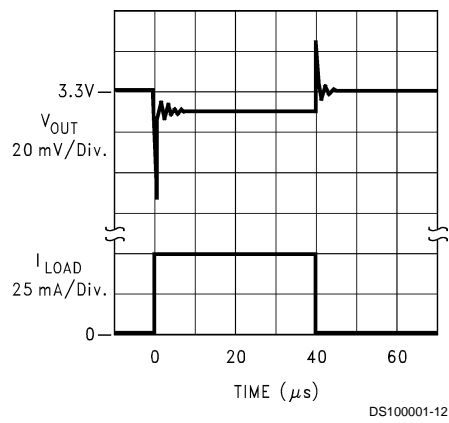

Line Transient Response

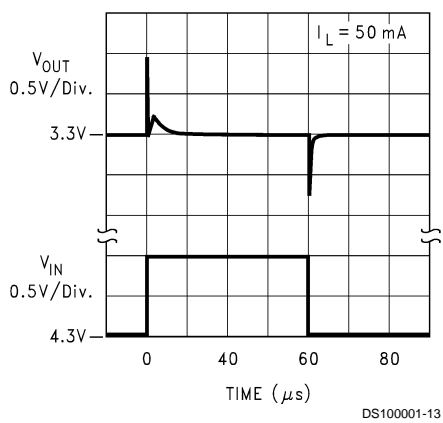

Short Circuit Current

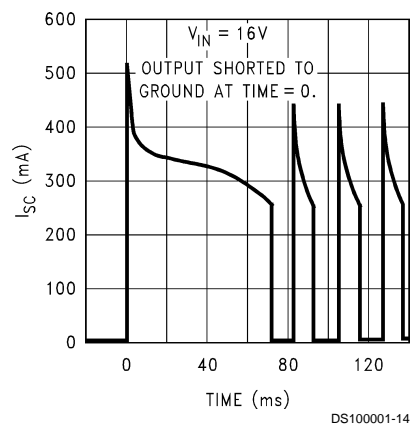

Typical Performance Characteristics Unless otherwise specified: $T_A = 25^\circ\text{C}$, $V_{IN} = V_O(\text{NOM}) + 1\text{V}$, $I_L = 1\text{ mA}$, ON/OFF pin tied to V_{IN} , $R_{ADJ} = 86.6\text{k}$, and test circuit is as shown in Basic Application Circuit. (Continued)

Short Circuit Current

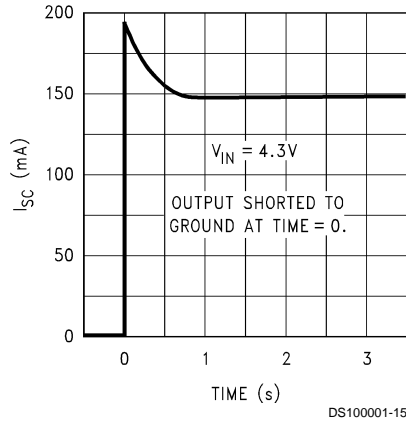

Load Regulation

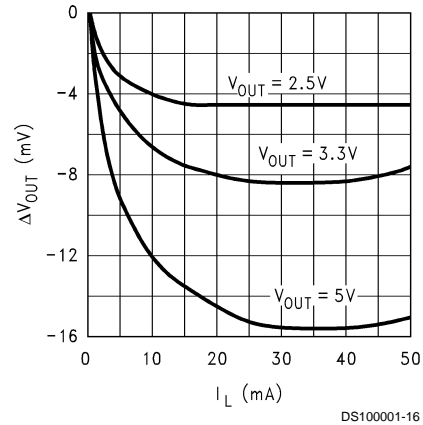

ADJ Pin Bias Current vs. Load Current

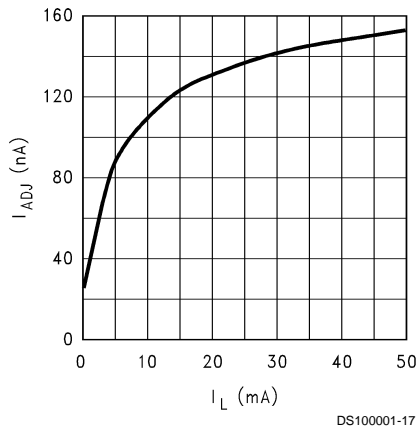

ADJ Pin Bias Current vs. Temperature

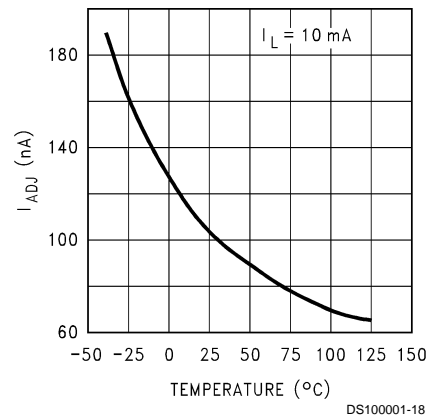

ON/OFF Threshold vs. Temperature

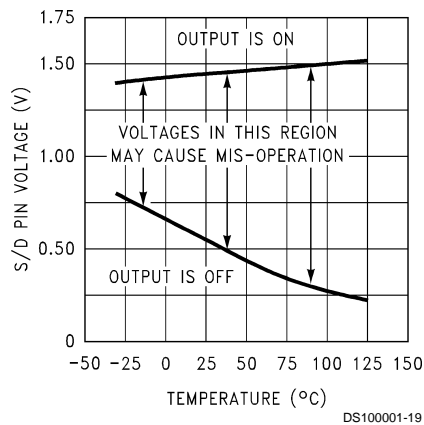

Output Noise Density

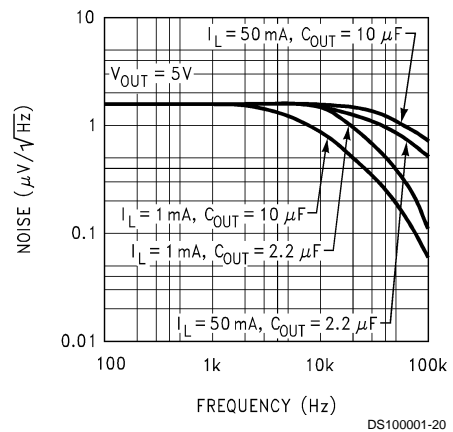

Typical Performance Characteristics Unless otherwise specified: $T_A = 25^\circ\text{C}$, $V_{IN} = V_{O(NOM)} + 1\text{V}$, $I_L = 1\text{ mA}$, ON/OFF pin tied to V_{IN} , $R_{ADJ} = 86.6\text{k}$, and test circuit is as shown in Basic Application Circuit. (Continued)

Ripple Rejection

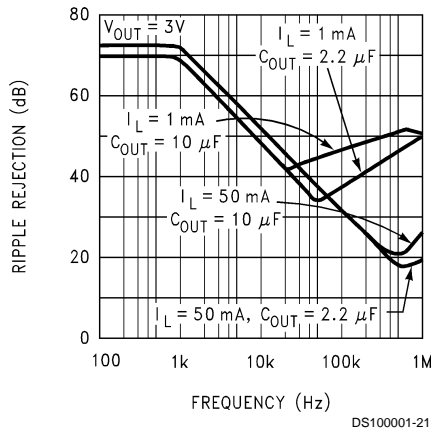

Application Hints

EXTERNAL CAPACITORS

Like any low-dropout regulator, the external capacitors must be selected carefully to assure regulator loop stability.

INPUT CAPACITOR: An input capacitor whose value is $\geq 1\ \mu\text{F}$ is *required* (the amount of capacitance may be increased without limit).

Any good quality Tantalum or Ceramic capacitor may be used here. The capacitor must be located not more than 0.5" from the input pin and returned to a clean analog ground.

OUTPUT CAPACITOR: The output capacitor must meet both the requirement for minimum amount of capacitance and E.S.R. (Equivalent Series Resistance) for stable operation.

Curves are provided below which show the allowable ESR of the output capacitor as a function of load current for both 2.2 μF and 4.7 μF . A solid Tantalum capacitor is the best choice for the output.

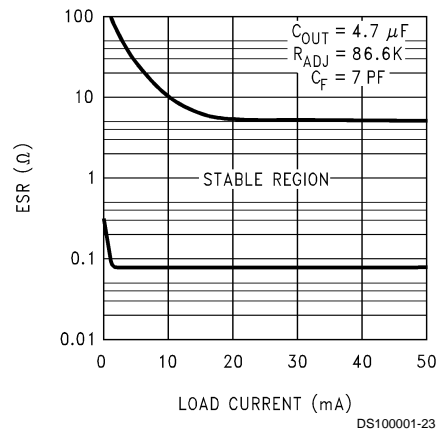

4.7 μF ESR Curves

IMPORTANT: The output capacitor must maintain its ESR in the stable region *over the full operating temperature range* to assure stability. Also, capacitor tolerance and variation with temperature must be considered to assure the minimum amount of capacitance is provided at all times.

Note that this capacitor must be located not more than 0.5" from the output pin and returned to a clean analog ground.

FEED-FORWARD CAPACITOR: A 7 pF feed-forward capacitor is required (see Basic Application Circuit). The function of this capacitor is to provide the lead compensation necessary for loop stability.

A temperature-stable ceramic capacitor (type NPO or COG) should be used here.

CAPACITOR CHARACTERISTICS

TANTALUM: The best capacitor choice for the LP2980-ADJ output is solid Tantalum. The ESR of a good quality Tantalum is almost perfectly centered in the middle of the "stable" range of the ESR curve (about 0.5 Ω –1 Ω).

The temperature stability of Tantalums is typically very good, with a total variation of only about 2:1 over the temperature range of -40°C to $+125^\circ\text{C}$ (ESR increases at colder temperatures).

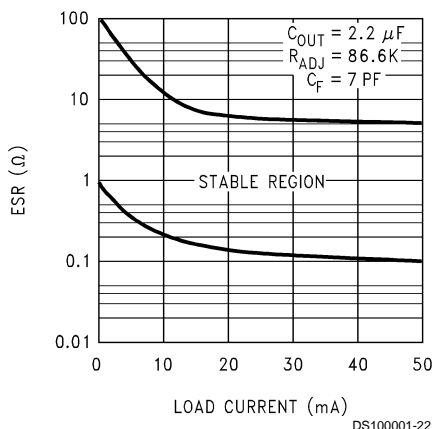

2.2 μF ESR Curves

Application Hints (Continued)

Off-brand capacitors should be avoided, as some poor quality Tantalums are seen with ESR's $> 10\Omega$, and this usually causes oscillation problems.

One caution about Tantalums if they are used on the input: the ESR of a Tantalum is low enough that it can be destroyed by surge current if powered up from a low impedance source (like a battery) that has no limit on inrush current. In these cases, use a ceramic input capacitor which does not have this problem.

CERAMIC: Ceramics are generally larger and more costly than Tantalums for a given amount of capacitance. Also, they have a very low ESR which is quite stable with temperature.

Be warned that the ESR of a ceramic capacitor is typically low enough to make an LDO oscillate: a 2.2 μF ceramic demonstrated an ESR of about 15 $\text{m}\Omega$ when tested. If used as an output capacitor, this will cause instability (see ESR Curves).

If a ceramic is used on the output of an LDO, a small resistance (about 1Ω) should be placed in series with the capacitor. If it is used as an input capacitor, no resistor is needed as there is no requirement for ESR on capacitors used on the input.

EXTERNAL RESISTORS

The output voltage is set using two external resistors (see Basic Application Circuit). It is recommended that the resistor from the ADJ pin to ground be 51.1k.

The other resistor (R_{ADJ}) which connects between V_{OUT} and the ADJ pin is selected to set V_{OUT} as given by the formula:

$$V_{\text{OUT}} = 1.23 + 1.23 (R_{\text{ADJ}}/51.1\text{k})$$

REVERSE CURRENT PATH

The power transistor used in the LP2980-ADJ has an inherent diode connected between the input and output pin (see below).

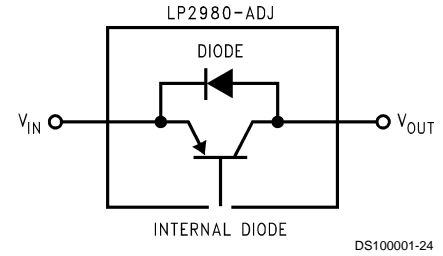

If the output is forced above the input by more than a V_{BE} , this diode will become forward biased and current will flow into the output pin and out the input pin. This current must be limited to $< 100 \text{ mA}$ to prevent damage to the part.

The internal diode can also be turned on if the input voltage is abruptly stepped down to a voltage which is a V_{BE} below the output voltage. To prevent mis-operation, an external Schottky diode (see below) must be used in applications where the internal diode may be turned on.

Since the external Schottky diode turns on at a lower voltage than the internal diode, the Schottky conducts all of the current and prevents the internal diode from becoming forward biased.

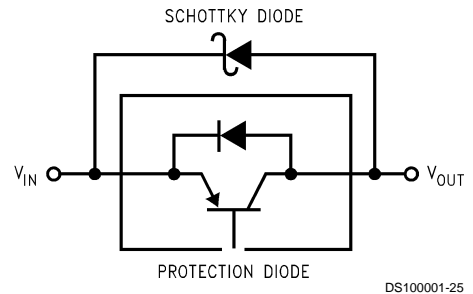

ON/OFF INPUT OPERATION

The LP2980-ADJ is shut off by driving the ON/OFF input low, and turned on by pulling the ON/OFF input high. If this feature is not to be used, the ON/OFF input must be tied to V_{IN} to keep the regulator output on at all times (the ON/OFF input must not be left floating).

To ensure proper operation, the signal source used to drive the ON/OFF input must be able to swing above and below the specified turn-on/turn-off voltage thresholds which guarantee an ON or OFF state (see Electrical Characteristics).

It is also important that the turn-on (and turn-off) voltage signals applied to the ON/OFF input have a slew rate which is greater than 40 $\text{mV}/\mu\text{s}$.

IMPORTANT: The shutdown function will not operate correctly if a slow-moving signal is used to drive the S/D input.

Physical Dimensions inches (millimeters) unless otherwise noted

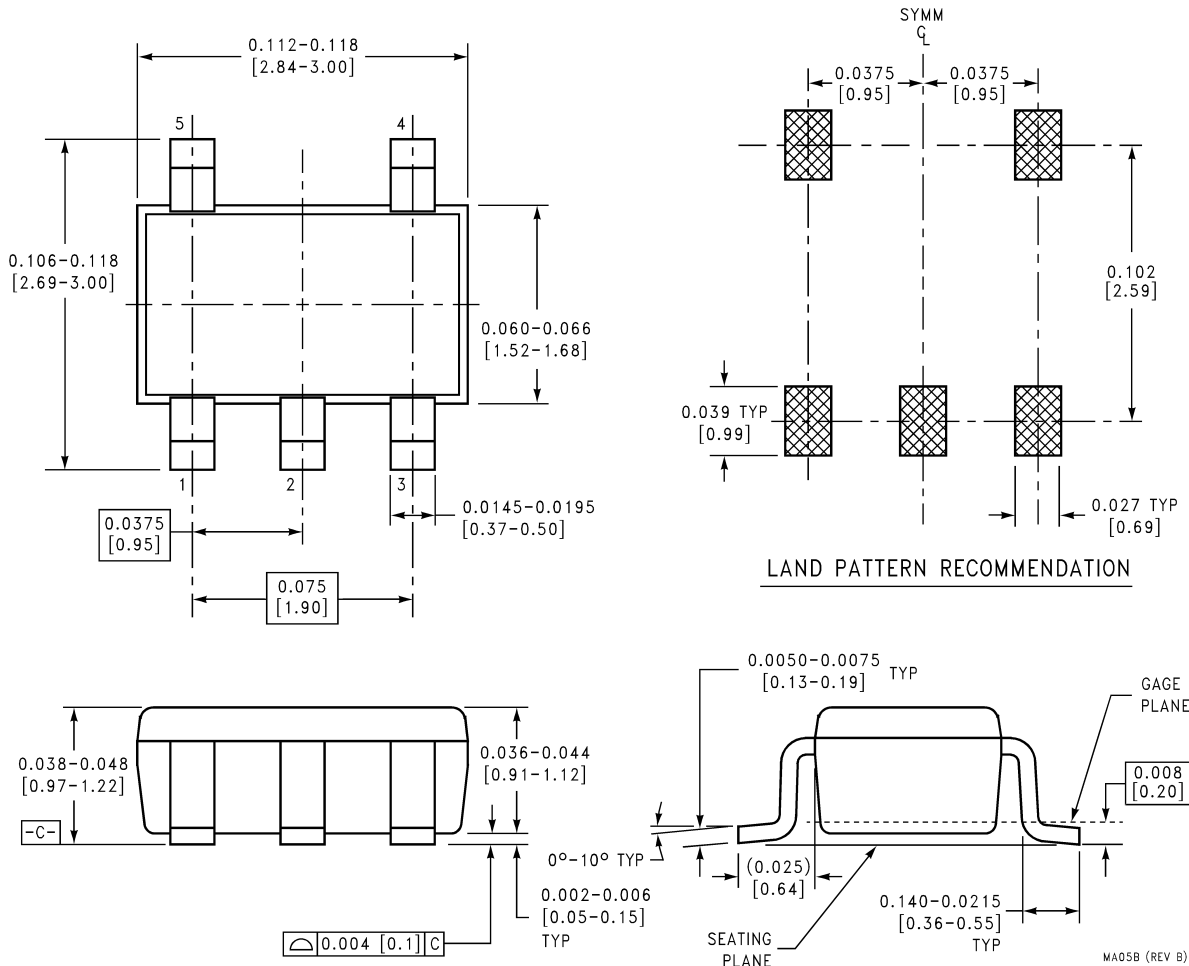

**5-Lead Small Outline Package (M5)
NS Package Number MA05B**

LIFE SUPPORT POLICY

NATIONAL'S PRODUCTS ARE NOT AUTHORIZED FOR USE AS CRITICAL COMPONENTS IN LIFE SUPPORT DEVICES OR SYSTEMS WITHOUT THE EXPRESS WRITTEN APPROVAL OF THE PRESIDENT AND GENERAL COUNSEL OF NATIONAL SEMICONDUCTOR CORPORATION. As used herein:

1. Life support devices or systems are devices or systems which, (a) are intended for surgical implant into the body, or (b) support or sustain life, and whose failure to perform when properly used in accordance with instructions for use provided in the labeling, can be reasonably expected to result in a significant injury to the user.
2. A critical component is any component of a life support device or system whose failure to perform can be reasonably expected to cause the failure of the life support device or system, or to affect its safety or effectiveness.

National Semiconductor Corporation
Americas
Tel: 1-800-272-9959
Fax: 1-800-737-7018
Email: support@nsc.com
www.national.com

National Semiconductor Europe
Fax: +49 (0) 180-530 85 86
Email: europe.support@nsc.com
Deutsch Tel: +49 (0) 69 9508 6208
English Tel: +44 (0) 870 24 0 2171
Français Tel: +33 (0) 1 41 91 8790

National Semiconductor Asia Pacific Customer Response Group
Tel: 65-2544466
Fax: 65-2504466
Email: ap.support@nsc.com

National Semiconductor Japan Ltd.
Tel: 81-3-5639-7560
Fax: 81-3-5639-7507