

3 mm (T1) LED, Diffused

LR 3360, LS 3360, LO 3360
LY 3360, LG 3360, LP 3360

Besondere Merkmale

- eingefärbtes, diffuses Gehäuse
- als optischer Indikator einsetzbar
- Lötspieße mit Aufsetzebene
- gegurtet lieferbar
- Störimpulsfest nach DIN 40839

Features

- colored, diffused package
- for use as optical indicator
- solder leads with stand-off
- available taped on reel
- load dump resistant acc. to DIN 40839

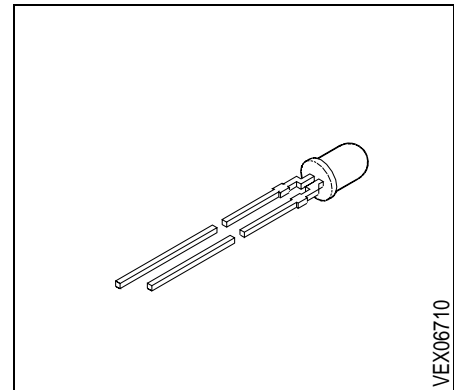

Typ Type	Emissionsfarbe Color of Emission	Gehäusefarbe Color of Package	Lichtstärke Luminous Intensity $I_F = 10 \text{ mA}$ $I_V \text{ (mcd)}$	Bestellnummer Ordering Code
LR 3360-DG LR 3360-F LR 3360-G LR 3360-FJ	red	red diffused	0.4 ... 3.2 1.0 ... 2.0 1.6 ... 3.2 1.0 ... 8.0	Q62703-Q1316 Q62703-Q1317 Q62703-Q1318 Q62703-Q1319
LS 3360-HL LS 3360-K LS 3360-L LS 3360-KN	super-red	red diffused	2.5 ... 20.0 6.3 ... 12.5 10.0 ... 20.0 6.3 ... 50.0	Q62703-Q1320 Q62703-Q1321 Q62703-Q1322 Q62703-Q1323
LO 3360-HL LO 3360-K LO 3360-L LO 3360-JM	orange	orange diffused	2.5 ... 20.0 6.3 ... 12.5 10.0 ... 20.0 4.0 ... 32.0	Q62703-Q1887 Q62703-Q2400 Q62703-Q2596 Q62703-Q2410
LY 3360-HL LY 3360-K LY 3360-L LY 3360-KN	yellow	yellow diffused	2.5 ... 20.0 6.3 ... 12.5 10.0 ... 20.0 6.3 ... 50.0	Q62703-Q1324 Q62703-Q1325 Q62703-Q1326 Q62703-Q1998
LG 3360-HL LG 3360-J LG 3360-K LG 3360-L LG 3360-KN	green	green diffused	2.5 ... 20.0 4.0 ... 8.0 6.3 ... 12.5 10.0 ... 20.0 6.3 ... 50.0	Q62703-Q3818 Q62703-Q1865 Q62703-Q2008 Q62703-Q3507 Q62703-Q3819
LP 3360-GK LP 3360-H LP 3360-J LP 3360-HL	pure green	green diffused	1.6 ... 12.5 2.5 ... 5.0 4.0 ... 8.0 2.5 ... 20.0	Q62703-Q2467 Q62703-Q2914 Q62703-Q2915 Q62703-Q3213

Streuung der Lichtstärke in einer Verpackungseinheit $I_{V \max} / I_{V \min} \leq 2.0$.

Luminous intensity ratio in one packaging unit $I_{V \max} / I_{V \min} \leq 2.0$.

Grenzwerte
Maximum Ratings

Bezeichnung Parameter	Symbol Symbol	Werte Values			Einheit Unit
		LS, LO, LY, LG	LR	LP	
Betriebstemperatur Operating temperature range	T_{op}	- 55 ... + 100			°C
Lagertemperatur Storage temperature range	T_{stg}	- 55 ... + 100			°C
Sperrschichttemperatur Junction temperature	T_j	+ 100			°C
Durchlaßstrom Forward current	I_F	40	45	30	mA
Stoßstrom Surge current $t \leq 10 \mu s, D = 0.005$	I_{FM}	0.5			A
Sperrspannung Reverse voltage	V_R	5			V
Verlustleistung Power dissipation $T_A \leq 25 \text{ °C}$	P_{tot}	140	100	100	mW
Wärmewiderstand Thermal resistance Sperrschicht / Luft Junction / air	$R_{th JA}$	400			K/W

Kennwerte ($T_A = 25\text{ °C}$)

Characteristics

Bezeichnung Parameter	Symbol Symbol	Werte Values						Einheit Unit
		LR	LS	LO	LY	LG	LP	
Wellenlänge des emittierten Lichtes(typ.) Wavelength at peak emission(typ.) $I_F = 20\text{ mA}$	λ_{peak}	660	635	610	586	565	557	nm
Dominantwellenlänge(typ.) Dominant wavelength(typ.) $I_F = 20\text{ mA}$	λ_{dom}	645	628	605	590	570	560	nm
Spektrale Bandbreite bei 50 % $I_{\text{rel max}}$ (typ.) Spectral bandwidth at 50 % $I_{\text{rel max}}$ (typ.) $I_F = 20\text{ mA}$	$\Delta\lambda$	35	45	40	45	25	22	nm
Abstrahlwinkel bei 50 % I_V (Vollwinkel) Viewing angle at 50 % I_V	2ϕ	70	70	70	70	70	70	Grad deg.
Durchlaßspannung(typ.) Forward voltage(max.) $I_F = 10\text{ mA}$	V_F V_F	1.6 2.0	2.0 2.6	2.0 2.6	2.0 2.6	2.0 2.6	2.0 2.6	V V
Sperrstrom(typ.) Reverse current(max.) $V_R = 5\text{ V}$	I_R I_R	0.01 10	0.01 10	0.01 10	0.01 10	0.01 10	0.01 10	μA μA
Kapazität(typ.) Capacitance $V_R = 0\text{ V}, f = 1\text{ MHz}$	C_0	25	12	8	10	15	15	pF
Schaltzeiten: Switching times: I_V from 10 % to 90 % (typ.) I_V from 90 % to 10 % (typ.) $I_F = 100\text{ mA}, t_P = 10\text{ }\mu\text{s}, R_L = 50\text{ }\Omega$	t_r t_f	120 50	300 150	300 150	300 150	450 200	450 200	ns ns

Relative spektrale Emission $I_{rel} = f(\lambda)$, $T_A = 25\text{ °C}$, $I_F = 20\text{ mA}$

Relative spectral emission

$V(\lambda)$ = spektrale Augenempfindlichkeit

Standard eye response curve

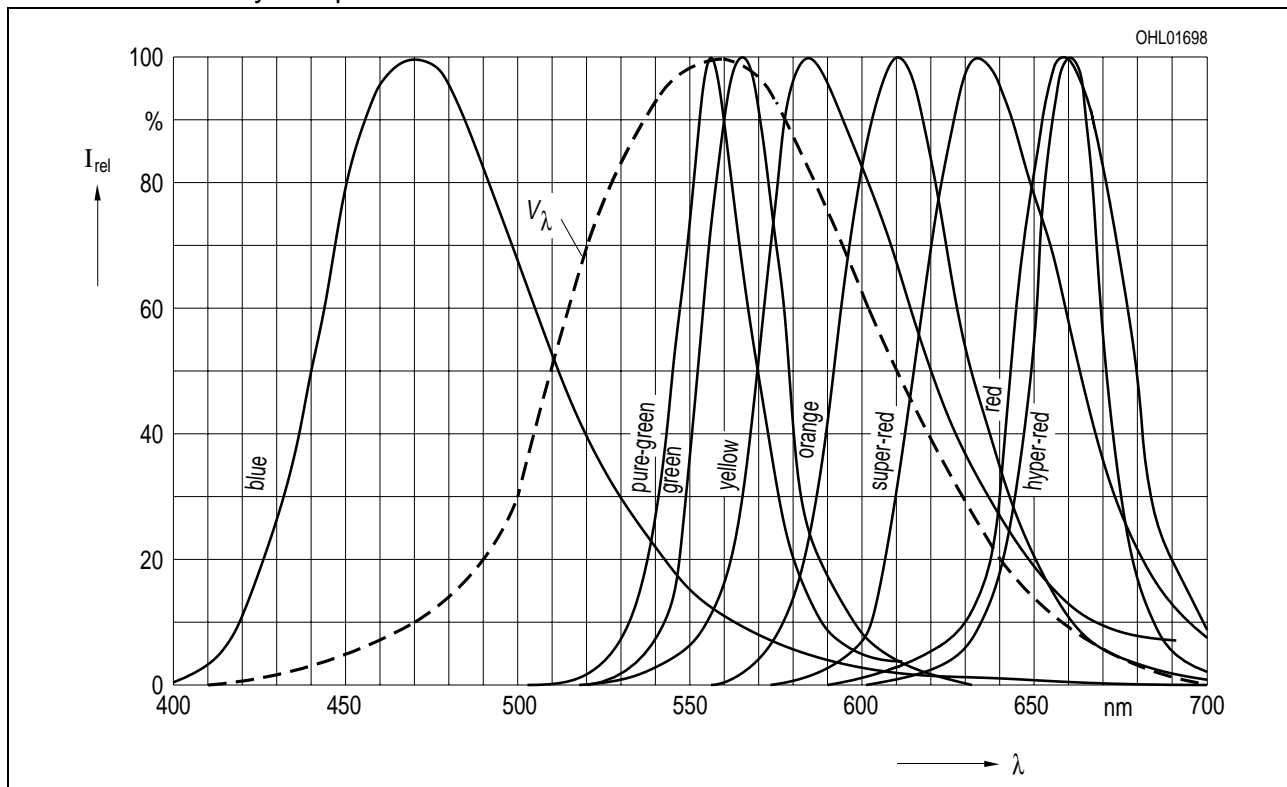

Abstrahlcharakteristik $I_{rel} = f(\varphi)$

Radiation characteristic

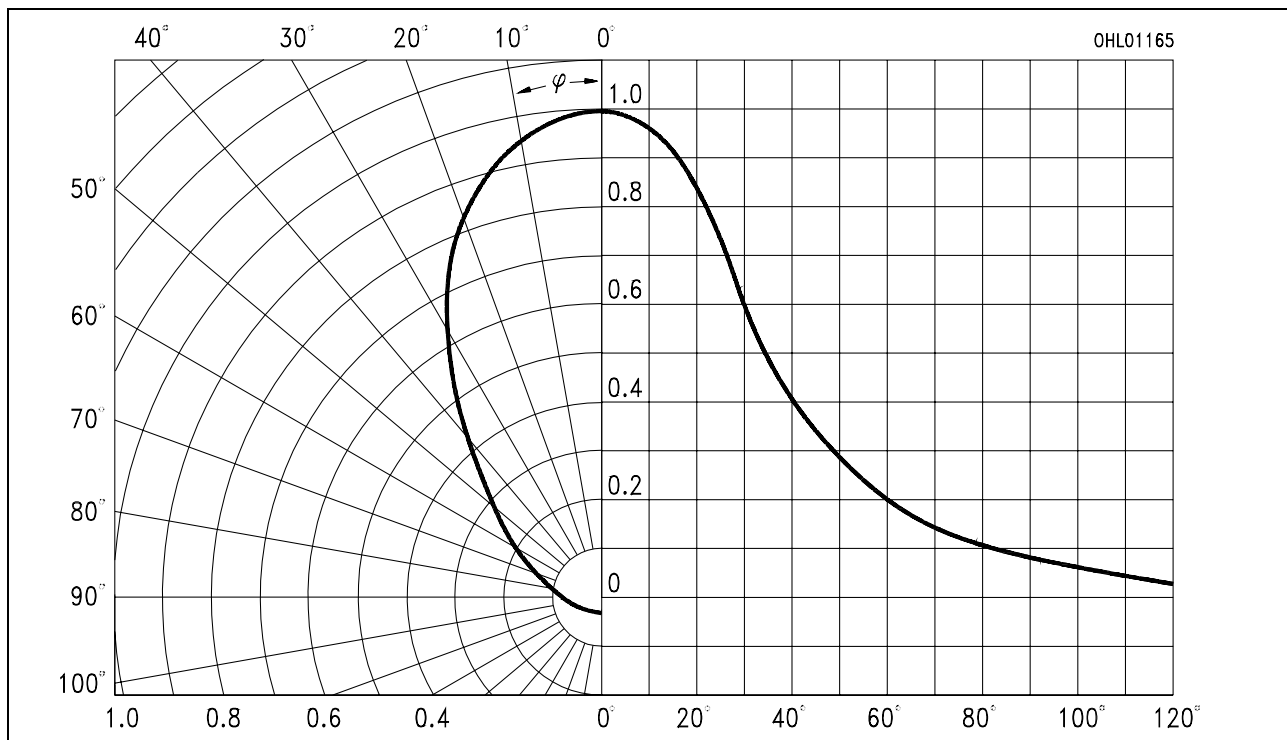

Durchlaßstrom $I_F = f(V_F)$
Forward current

$T_A = 25\text{ °C}$

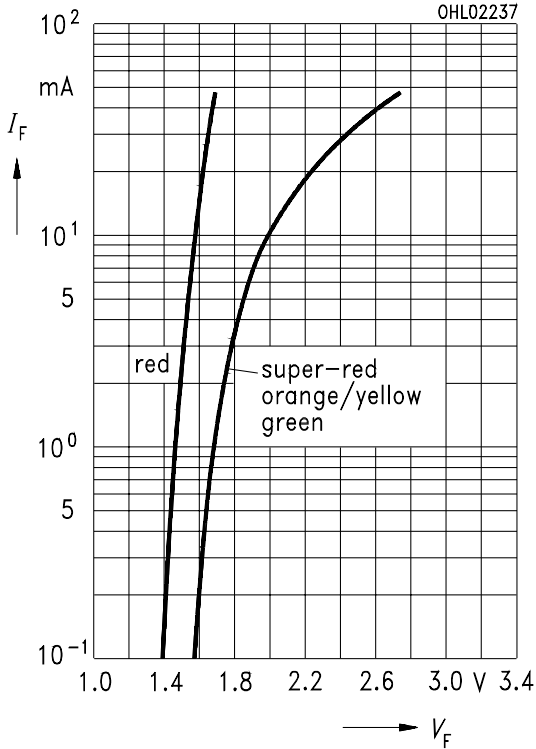

Relative Lichtstärke $I_V/I_{V(10\text{ mA})} = f(I_F)$
Relative luminous intensity

$T_A = 25\text{ °C}$

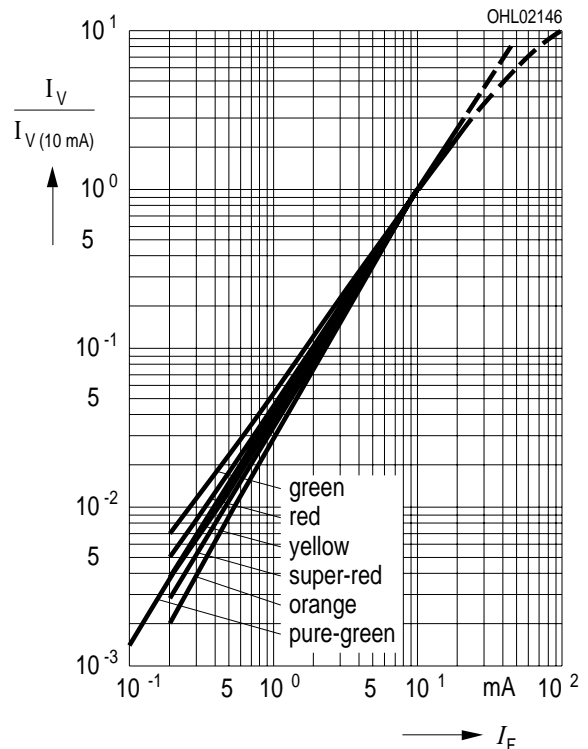

Zulässige Impulsbelastbarkeit $I_F = f(t_p)$
Permissible pulse handling capability

Duty cycle $D = \text{parameter}$, $T_A = 25\text{ °C}$

LS, LO, LY, LG

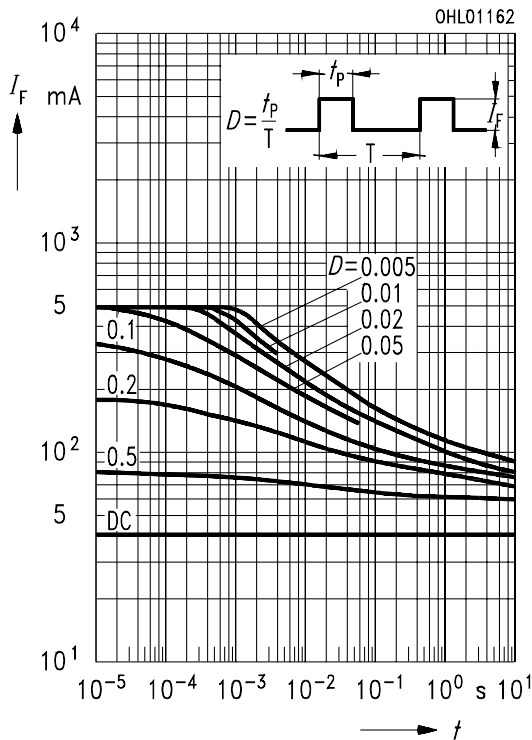

Zulässige Impulsbelastbarkeit $I_F = f(t_p)$
Permissible pulse handling capability

Duty cycle $D = \text{parameter}$, $T_A = 25\text{ °C}$

LR

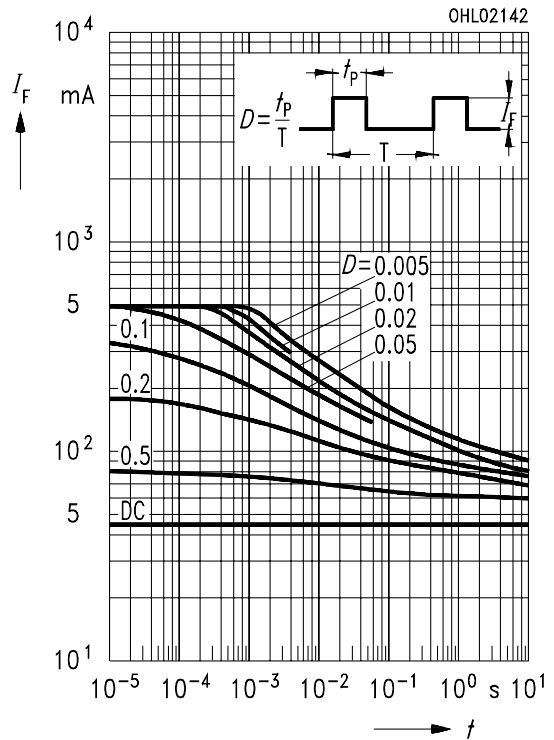

Zulässige Impulsbelastbarkeit $I_F = f(t_p)$
Permissible pulse handling capability
 Duty cycle $D =$ parameter, $T_A = 25\text{ °C}$
LP

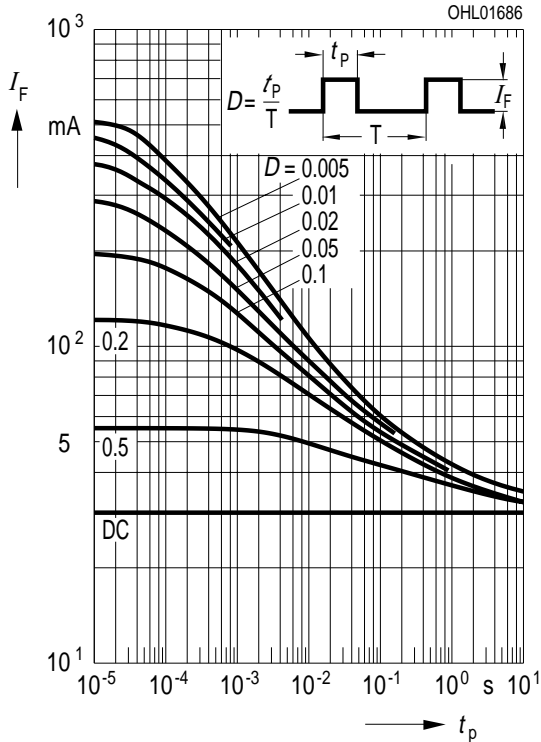

Maximal zulässiger Durchlaßstrom
Max. permissible forward current
 $I_F = f(T_A)$

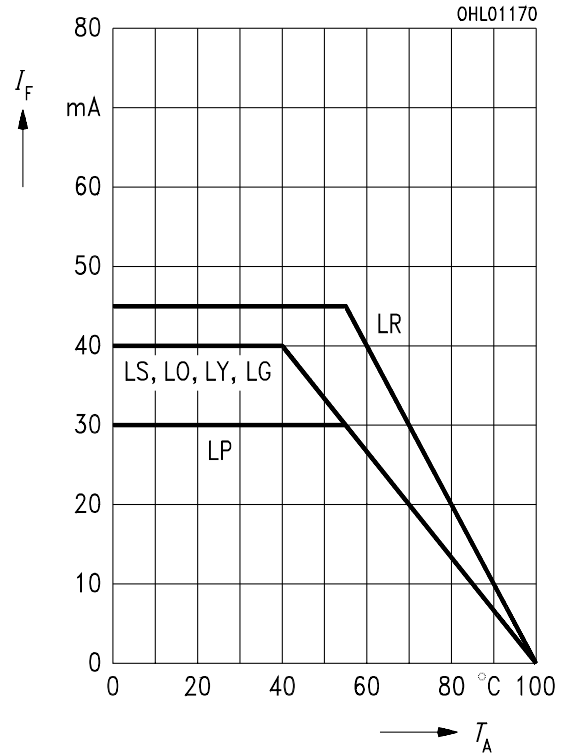

Wellenlänge der Strahlung $\lambda_{peak} = f(T_A)$
Wavelength at peak emission
 $I_F = 20\text{ mA}$

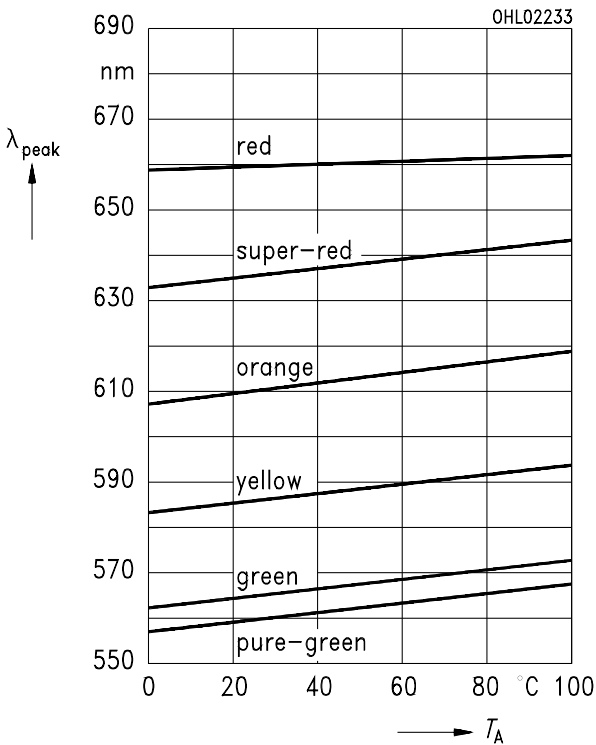

Dominantwellenlänge $\lambda_{dom} = f(T_A)$
Dominant wavelength
 $I_F = 20\text{ mA}$

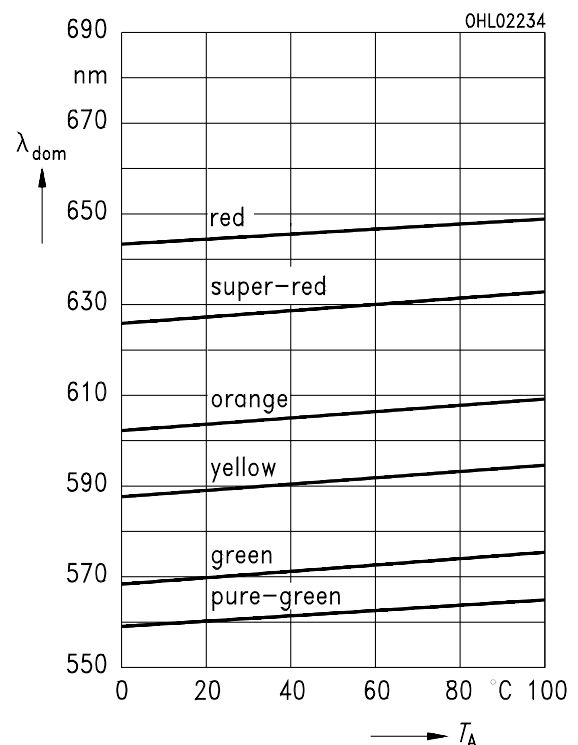

Durchlaßspannung $V_F = f(T_A)$

Forward voltage

$I_F = 10 \text{ mA}$

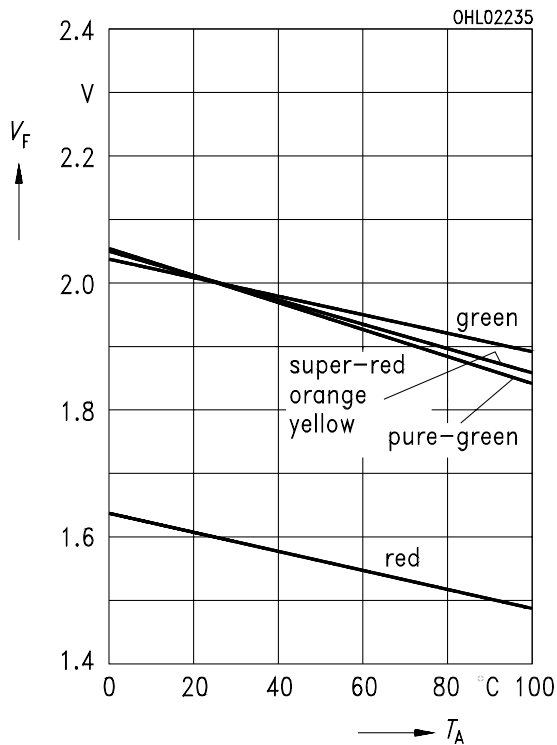

Relative Lichtstärke $I_V/I_{V(25^\circ\text{C})} = f(T_A)$

Relative luminous intensity

$I_F = 10 \text{ mA}$

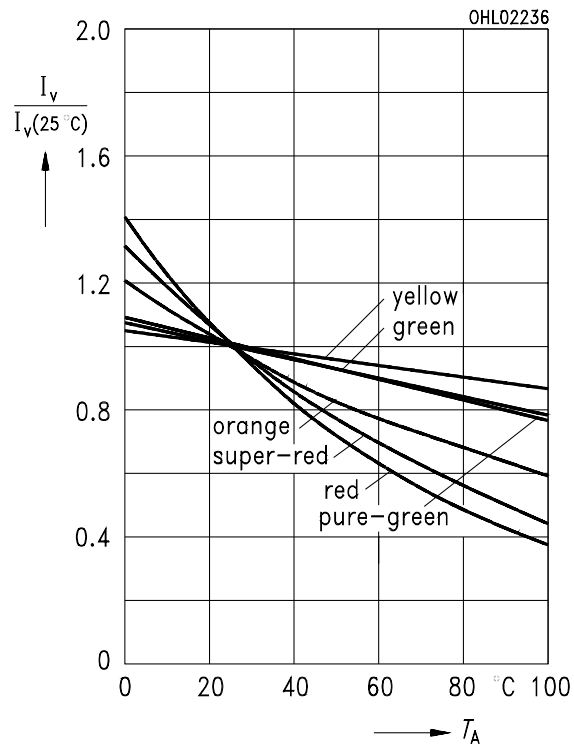

Maßzeichnung
Package Outlines

(Maße in mm, wenn nicht anders angegeben)
(Dimensions in mm, unless otherwise specified)

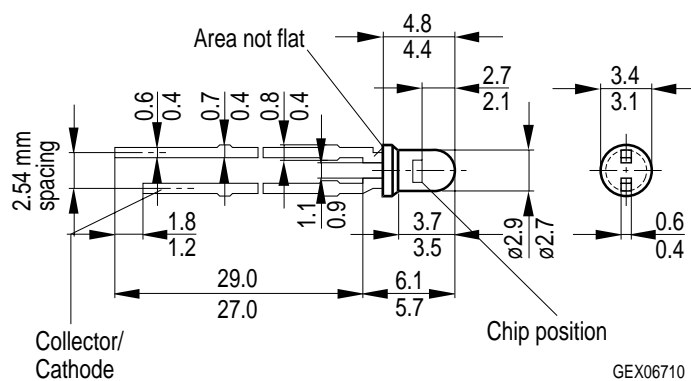

Kathodenkennzeichnung: Kürzerer Lötspieß
Cathode mark: Short solder lead