



# LPC12D27

32-bit ARM Cortex-M0 microcontroller; 128 kB flash and 8 kB SRAM; 40 segment x 4 LCD driver

Rev. 1 — 20 September 2011

Product data sheet

## 1. General description

The LPC12D27 are ARM Cortex-M0 based microcontrollers for embedded applications featuring a high level of integration and low power consumption. The ARM Cortex-M0 is a next generation core that offers system enhancements such as enhanced debug features and a higher level of support block integration.

The LPC12D27 is a dual-chip module consisting of a LPC1227 single-chip microcontroller combined with a PCF8576D Universal LCD driver in a low-cost 100-pin package. The LCD driver provides 40 segments and supports from one to four backplanes. Display overhead is minimized by an on-chip display RAM with auto-increment addressing.

The LPC12D27 operate at CPU frequencies of up to 45 MHz and include 128 kB of flash memory and 8 kB of data memory.

The peripheral complement of the LPC1227 microcontroller includes a micro DMA controller, one Fast-mode Plus I<sup>2</sup>C interface, one SSP interface, two UARTs, four general purpose timers, a 10-bit ADC, two comparators, and up to 40 general purpose I/O pins.

**Remark:** For a functional description of the LPC1227 microcontroller see the *LPC122x data sheet*. For a detailed description of the LCD driver see the *PCF8576D data sheet*. Both data sheets are available at <http://www.nxp.com/microcontrollers>

## 2. Features and benefits

- LCD driver
  - ◆ 40 segments.
  - ◆ One to four backplanes.
  - ◆ On-chip display RAM with auto-increment addressing.
- Processor core
  - ◆ ARM Cortex-M0 processor, running at frequencies of up to 45 MHz (one wait state from flash) or 30 MHz (zero wait states from flash). The LPC12D27 have a high score of over 45 in CoreMark CPU performance benchmark testing, equivalent to 1.51/MHz.
  - ◆ ARM Cortex-M0 built-in Nested Vectored Interrupt Controller (NVIC).
  - ◆ Serial Wire Debug (SWD).
  - ◆ System tick timer.
- Memory
  - ◆ 8 kB SRAM.
  - ◆ 128 kB on-chip flash programming memory.



- ◆ In-System Programming (ISP) and In-Application Programming (IAP) via on-chip bootloader software.
- ◆ Includes ROM-based 32-bit integer division routines.
- Clock generation unit
  - ◆ Crystal oscillator with an operating range of 1 MHz to 25 MHz.
  - ◆ 12 MHz Internal RC (IRC) oscillator trimmed to 1 % accuracy that can optionally be used as a system clock.
  - ◆ PLL allows CPU operation up to the maximum CPU rate without the need for a high-frequency crystal. May be run from the system oscillator or the internal RC oscillator.
  - ◆ Clock output function with divider that can reflect the system oscillator clock, IRC clock, main clock, and Watchdog clock.
  - ◆ Real-Time Clock (RTC).
- Digital peripherals
  - ◆ Micro DMA controller with 21 channels.
  - ◆ CRC engine.
  - ◆ Two UARTs with fractional baud rate generation and internal FIFO. One UART with RS-485 and modem support and one standard UART with IrDA.
  - ◆ SSP/SPI controller with FIFO and multi-protocol capabilities.
  - ◆ I<sup>2</sup>C-bus interface supporting full I<sup>2</sup>C-bus specification and Fast-mode Plus with a data rate of 1 Mbit/s with multiple address recognition and monitor mode. I<sup>2</sup>C-bus pins have programmable glitch filter.
  - ◆ Up to 40 General Purpose I/O (GPIO) pins with programmable pull-up resistor, open-drain mode, programmable digital input glitch filter, and programmable input inverter.
  - ◆ Programmable output drive on all GPIO pins. Four pins support high-current output drivers.
  - ◆ All GPIO pins can be used as edge and level sensitive interrupt sources.
  - ◆ Four general purpose counter/timers with four capture inputs and four match outputs (32-bit timers) or two capture inputs and two match outputs (16-bit timers).
  - ◆ Windowed WatchDog Timer (WWDt), IEC-60335 Class B certified.
- Analog peripherals
  - ◆ One 8-channel, 10-bit ADC.
  - ◆ Two highly flexible analog comparators. Comparator outputs can be programmed to trigger a timer match signal or can be used to emulate 555 timer behavior.
- Power
  - ◆ Three reduced power modes: Sleep, Deep-sleep, and Deep power-down.
  - ◆ Processor wake-up from Deep-sleep mode via start logic using 12 port pins.
  - ◆ Processor wake-up from Deep-power down and Deep-sleep modes via the RTC.
  - ◆ Brownout detect with three separate thresholds each for interrupt and forced reset.
  - ◆ Power-On Reset (POR).
  - ◆ Integrated PMU (Power Management Unit).
- Unique device serial number for identification.
- 3.3 V power supply.
- Available as 100-pin LQFP package.

### 3. Applications

- White goods
- Portable medical devices
- Lighting control
- Thermostats
- Alarm systems

### 4. Ordering information

Table 1. Ordering information

Type number	Package		
	Name	Description	Version
LPC12D27FBD100/301	LQFP100	plastic low profile quad flat package; 100 leads; body 14 × 14 × 1.4 mm	SOT407-1

#### 4.1 Ordering options

Table 2. Ordering options for LPC12D27

Type number	Flash	Total SRAM	UART RS-485	I <sup>2</sup> C/ FM+	SSP	ADC channels	Package
LPC12D27FBD100/301	128 kB	8 kB	1	1	1	8	LQFP100

### 5. Block diagram

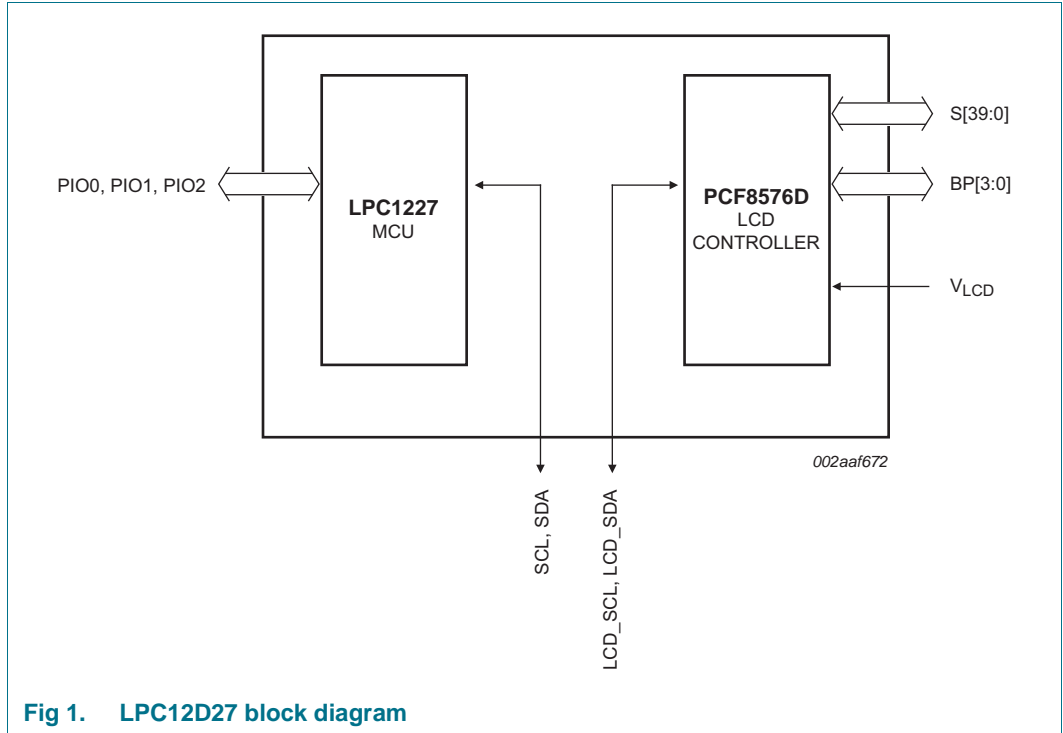

Fig 1. LPC12D27 block diagram

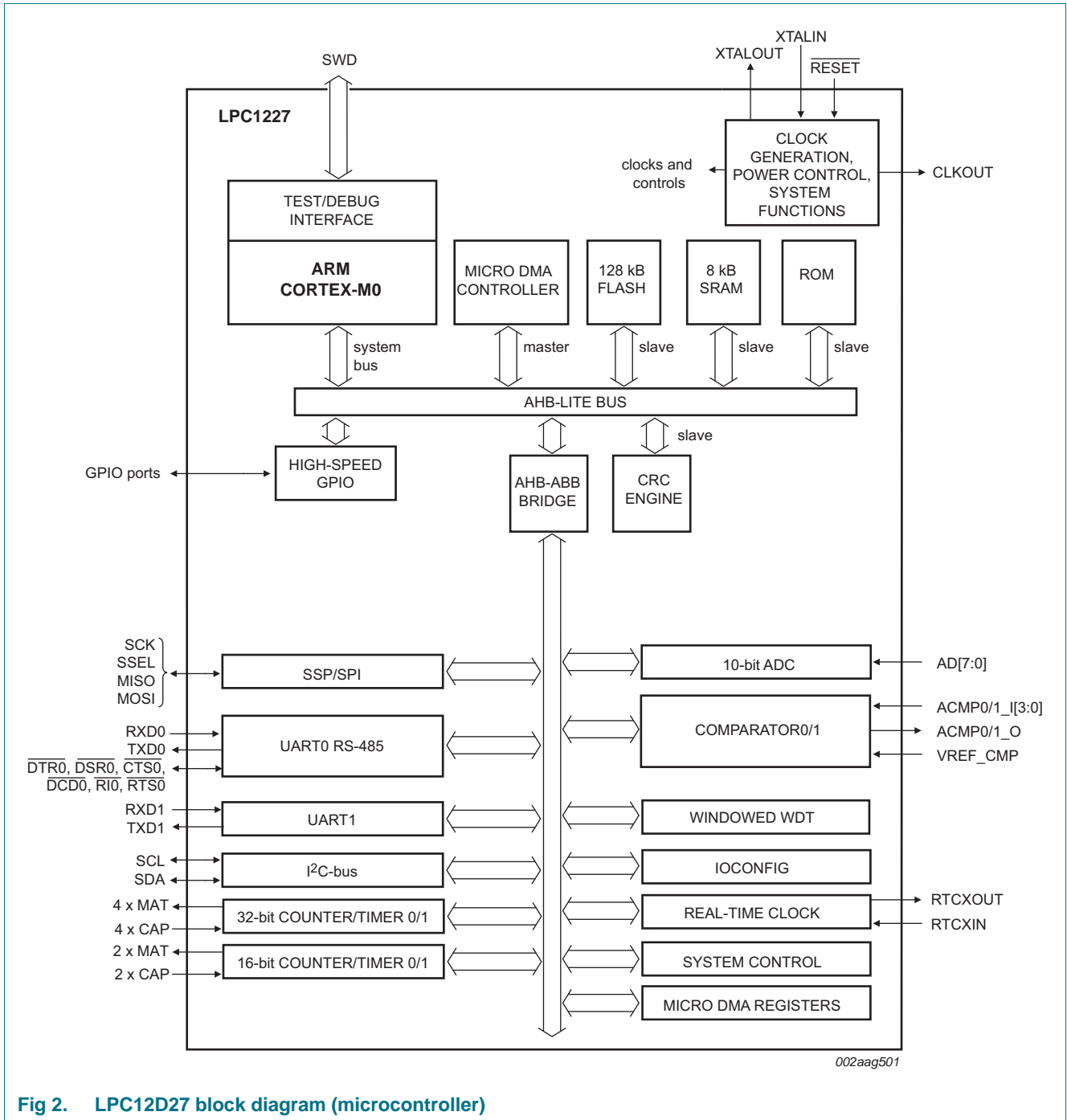

Fig 2. LPC12D27 block diagram (microcontroller)



## 6. Pinning information

### 6.1 Pinning

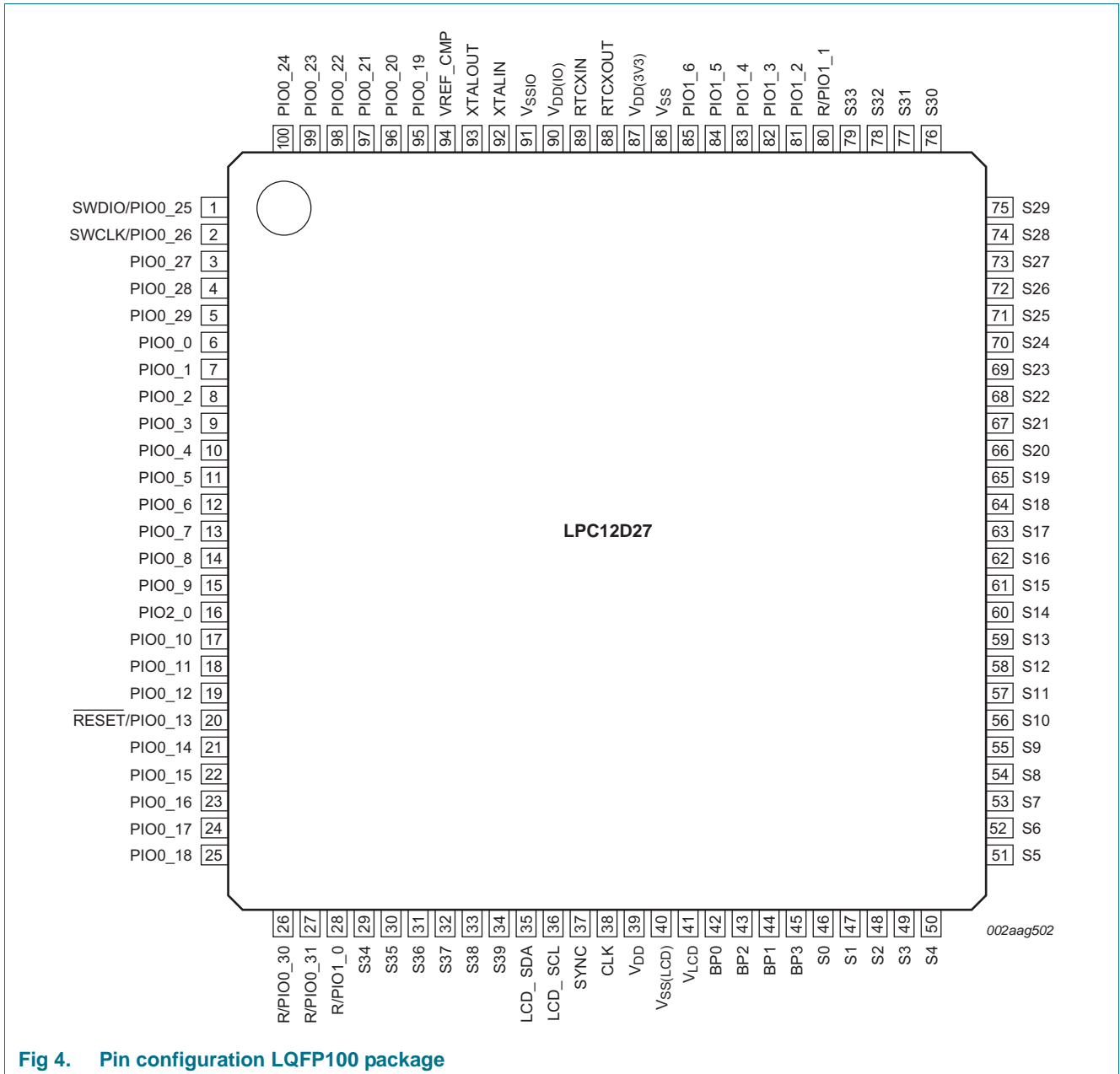

Fig 4. Pin configuration LQFP100 package

## 6.2 Pin description

All pins except the supply pins and the LCD pins can have more than one function as shown in [Table 3](#). The pin function is selected through the pin's IOCON register in the IOCONFIG block. The multiplexed functions include the counter/timer inputs and outputs, the UART receive, transmit, and control functions, and the serial wire debug functions.

For each pin, the default function is listed first together with the pin's reset state.

**Table 3. LPC12D27 LQFP100 pin description**

Symbol	Pin	Start logic input	Reset state <a href="#">[1]</a>	Type	Description
<b>Microcontroller pins</b>					
PIO0_0 to PIO0_31				I/O	<b>Port 0</b> — Port 0 is a 32-bit I/O port with individual direction and function controls for each bit. The operation of port 0 pins depends on the function selected through the IOCONFIG register block.
PIO0_0/ $\overline{\text{RTS0}}$	6 <a href="#">[2]</a>	yes	I; PU	I/O	<b>PIO0_0</b> — General purpose digital input/output pin. Also serves as wake-up pin from Deep-sleep mode.
				O	$\overline{\text{RTS0}}$ — Request To Send output for UART0.
PIO0_1/RXD0/ CT32B0_CAP0/ CT32B0_MAT0	7 <a href="#">[2]</a>	yes	I; PU	I/O	<b>PIO0_1</b> — General purpose digital input/output pin. Also serves as wake-up pin from Deep-sleep mode.
				I	<b>RXD0</b> — Receiver input for UART0.
				I	<b>CT32B0_CAP0</b> — Capture input, channel 0 for 32-bit timer 0.
				O	<b>CT32B0_MAT0</b> — Match output, channel 0 for 32-bit timer 0.
PIO0_2/TXD0/ CT32B0_CAP1/ CT32B0_MAT1	8 <a href="#">[2]</a>	yes	I; PU	I/O	<b>PIO0_2</b> — General purpose digital input/output pin. Also serves as wake-up pin from Deep-sleep mode.
				O	<b>TXD0</b> — Transmitter output for UART0.
				I	<b>CT32B0_CAP1</b> — Capture input, channel 1 for 32-bit timer 0.
				O	<b>CT32B0_MAT1</b> — Match output, channel 1 for 32-bit timer 0.
PIO0_3/ $\overline{\text{DTR0}}$ / CT32B0_CAP2/ CT32B0_MAT2	9 <a href="#">[2]</a>	yes	I; PU	I/O	<b>PIO0_3</b> — General purpose digital input/output pin. Also serves as wake-up pin from Deep-sleep mode.
				O	$\overline{\text{DTR0}}$ — Data Terminal Ready output for UART0.
				I	<b>CT32B0_CAP2</b> — Capture input, channel 2 for 32-bit timer 0.
				O	<b>CT32B0_MAT2</b> — Match output, channel 2 for 32-bit timer 0.
PIO0_4/ CT32B0_CAP3/ CT32B0_MAT3	10 <a href="#">[2]</a>	yes	I; PU	I/O	<b>PIO0_4</b> — General purpose digital input/output pin. Also serves as wake-up pin from Deep-sleep mode.
				I	<b>DSR0</b> — Data Set Ready input for UART0.
				I	<b>CT32B0_CAP3</b> — Capture input, channel 3 for 32-bit timer 0.
				O	<b>CT32B0_MAT3</b> — Match output, channel 3 for 32-bit timer 0.
PIO0_5/ $\overline{\text{DCD0}}$	11 <a href="#">[2]</a>	yes	I; PU	I/O	<b>PIO0_5</b> — General purpose digital input/output pin. Also serves as wake-up pin from Deep-sleep mode.
				I	$\overline{\text{DCD0}}$ — Data Carrier Detect input for UART0.



Table 3. LPC12D27 LQFP100 pin description ...continued

Symbol	Pin	Start logic input	Reset state	Type	Description
PIO0_6/ $\overline{\text{RI0}}$ / CT32B1_CAP0/ CT32B1_MAT0	12 <sup>[2]</sup>	yes	I; PU	I/O	<b>PIO0_6</b> — General purpose digital input/output pin. Also serves as wake-up pin from Deep-sleep mode.
				I	<b><math>\overline{\text{RI0}}</math></b> — Ring Indicator input for UART0.
				I	<b>CT32B1_CAP0</b> — Capture input, channel 0 for 32-bit timer 1.
				O	<b>CT32B1_MAT0</b> — Match output, channel 0 for 32-bit timer 1.
PIO0_7/ $\overline{\text{CTS0}}$ / CT32B1_CAP1/ CT32B1_MAT1	13 <sup>[2]</sup>	yes	I; PU	I/O	<b>PIO0_7</b> — General purpose digital input/output pin. Also serves as wake-up pin from Deep-sleep mode.
				I	<b><math>\overline{\text{CTS0}}</math></b> — Clear To Send input for UART0.
				I	<b>CT32B1_CAP1</b> — Capture input, channel 1 for 32-bit timer 1.
				O	<b>CT32B1_MAT1</b> — Match output, channel 1 for 32-bit timer 1.
PIO0_8/RXD1 /CT32B1_CAP2/ CT32B1_MAT2	14 <sup>[2]</sup>	yes	I; PU	I/O	<b>PIO0_8</b> — General purpose digital input/output pin. Also serves as wake-up pin from Deep-sleep mode.
				I	<b>RXD1</b> — Receiver input for UART1.
				I	<b>CT32B1_CAP2</b> — Capture input, channel 2 for 32-bit timer 1.
				O	<b>CT32B1_MAT2</b> — Match output, channel 2 for 32-bit timer 1.
PIO0_9/TXD1/ CT32B1_CAP3/ CT32B1_MAT3	15 <sup>[2]</sup>	yes	I; PU	I/O	<b>PIO0_9</b> — General purpose digital input/output pin. Also serves as wake-up pin from Deep-sleep mode.
				O	<b>TXD1</b> — Transmitter output for UART1.
				I	<b>CT32B1_CAP3</b> — Capture input, channel 3 for 32-bit timer 1.
				O	<b>CT32B1_MAT3</b> — Match output, channel 3 for 32-bit timer 1.
PIO0_10/SCL	17 <sup>[3]</sup>	yes	I; IA	I/O	<b>PIO0_10</b> — General purpose digital input/output pin. Also serves as wake-up pin from Deep-sleep mode.
				I/O	<b>SCL</b> — I <sup>2</sup> C-bus clock input/output.
PIO0_11/SDA/ CT16B0_CAP0/ CT16B0_MAT0	18 <sup>[3]</sup>	yes	I; IA	I/O	<b>PIO0_11</b> — General purpose digital input/output pin. Also serves as wake-up pin from Deep-sleep mode.
				I/O	<b>SDA</b> — I <sup>2</sup> C-bus data input/output.
				I	<b>CT16B0_CAP0</b> — Capture input, channel 0 for 16-bit timer 0.
				O	<b>CT16B0_MAT0</b> — Match output, channel 0 for 16-bit timer 0.
PIO0_12/CLKOUT/ CT16B0_CAP1/ CT16B0_MAT1	19 <sup>[7]</sup>	no	I; PU	I/O	<b>PIO0_12</b> — General purpose digital input/output pin. A LOW level on this pin in during reset starts the ISP command handler. High-current output driver.
				O	<b>CLKOUT</b> — Clock out pin.
				I	<b>CT16B0_CAP1</b> — Capture input, channel 0 for 16-bit timer 0.
				O	<b>CT16B0_MAT1</b> — Match output, channel 1 for 16-bit timer 0.
RESET/PIO0_13	20 <sup>[4]</sup>	no	I; PU	I	<b>RESET</b> — External reset input: A LOW on this pin resets the device, causing I/O ports and peripherals to take on their default states, and processor execution to begin at address 0.
				I/O	<b>PIO0_13</b> — General purpose digital input/output pin.
PIO0_14/SCK	21 <sup>[2]</sup>	no	I; PU	I/O	<b>PIO0_14</b> — General purpose digital input/output pin.
				I/O	<b>SCK</b> — Serial clock for SSP.

Table 3. LPC12D27 LQFP100 pin description ...continued

Symbol	Pin	Start logic input	Reset state	Type	Description
PIO0_15/SSEL/ CT16B1_CAP0/ CT16B1_MAT0	22 <sup>[2]</sup>	no	I; PU	I/O	<b>PIO0_15</b> — General purpose digital input/output pin.
				I/O	<b>SSEL</b> — Slave select for SSP.
				I	<b>CT16B1_CAP0</b> — Capture input, channel 0 for 16-bit timer 1.
				O	<b>CT16B1_MAT0</b> — Match output, channel 0 for 16-bit timer 1.
PIO0_16/MISO/ CT16B1_CAP1/ CT16B1_MAT1	23 <sup>[2]</sup>	no	I; PU	I/O	<b>PIO0_16</b> — General purpose digital input/output pin.
				I/O	<b>MISO</b> — Master In Slave Out for SSP.
				I	<b>CT16B1_CAP1</b> — Capture input, channel 1 for 16-bit timer 1.
				O	<b>CT16B1_MAT1</b> — Match output, channel 1 for 16-bit timer 1.
PIO0_17/MOSI	24 <sup>[2]</sup>	no	I; PU	I/O	<b>PIO0_17</b> — General purpose digital input/output pin.
				I/O	<b>MOSI</b> — Master Out Slave In for SSP.
PIO0_18/SWCLK/ CT32B0_CAP0/ CT32B0_MAT0	25 <sup>[2]</sup>	no	I; PU	I/O	<b>PIO0_18</b> — General purpose digital input/output pin.
				I	<b>SWCLK</b> — Serial wire clock, alternate location.
				I	<b>CT32B0_CAP0</b> — Capture input, channel 0 for 32-bit timer 0.
				O	<b>CT32B0_MAT0</b> — Match output, channel 0 for 32-bit timer 0.
PIO0_19/ACMP0_I0/ CT32B0_CAP1/ CT32B0_MAT1	95 <sup>[5]</sup>	no	I; PU	I/O	<b>PIO0_19</b> — General purpose digital input/output pin.
				I	<b>ACMP0_I0</b> — Input 0 for comparator 0.
				I	<b>CT32B0_CAP1</b> — Capture input, channel 1 for 32-bit timer 0.
				O	<b>CT32B0_MAT1</b> — Match output, channel 1 for 32-bit timer 0.
PIO0_20/ACMP0_I1/ CT32B0_CAP2/ CT32B0_MAT2	96 <sup>[5]</sup>	no	I; PU	I/O	<b>PIO0_20</b> — General purpose digital input/output pin.
				I	<b>ACMP0_I1</b> — Input 1 for comparator 0.
				I	<b>CT32B0_CAP2</b> — Capture input, channel 2 for 32-bit timer 0.
				O	<b>CT32B0_MAT2</b> — Match output, channel 2 for 32-bit timer 0.
PIO0_21/ACMP0_I2/ CT32B0_CAP3/ CT32B0_MAT3	97 <sup>[5]</sup>	no	I; PU	I/O	<b>PIO0_21</b> — General purpose digital input/output pin.
				I	<b>ACMP0_I2</b> — Input 2 for comparator 0.
				I	<b>CT32B0_CAP3</b> — Capture input, channel 3 for 32-bit timer 0.
				O	<b>CT32B0_MAT3</b> — Match output, channel 3 for 32-bit timer 0.
PIO0_22/ACMP0_I3	98 <sup>[5]</sup>	no	I; PU	I/O	<b>PIO0_22</b> — General purpose digital input/output pin.
				I	<b>ACMP0_I3</b> — Input 3 for comparator 0.
PIO0_23/ ACMP1_I0/ CT32B1_CAP0/ CT32B1_MAT0	99 <sup>[5]</sup>	no	I; PU	I/O	<b>PIO0_23</b> — General purpose digital input/output pin.
				I	<b>ACMP1_I0</b> — Input 0 for comparator 1.
				I	<b>CT32B1_CAP0</b> — Capture input, channel 0 for 32-bit timer 1.
				O	<b>CT32B1_MAT0</b> — Match output, channel 0 for 32-bit timer 1.
PIO0_24/ACMP1_I1/ CT32B1_CAP1/ CT32B1_MAT1	100 <sup>[5]</sup>	no	I; PU	I/O	<b>PIO0_24</b> — General purpose digital input/output pin.
				I	<b>ACMP1_I1</b> — Input 1 for comparator 1.
				I	<b>CT32B1_CAP1</b> — Capture input, channel 1 for 32-bit timer 1.
				O	<b>CT32B1_MAT1</b> — Match output, channel 1 for 32-bit timer 1.

Table 3. LPC12D27 LQFP100 pin description ...continued

Symbol	Pin	Start logic input	Reset state	Type	Description
SWDIO/ACMP1_I2/ CT32B1_CAP2/ CT32B1_MAT2/PIO0_25	1 <sup>[5]</sup>	no	I; PU	I/O	<b>SWDIO</b> — Serial wire debug input/output, default location.
				I	<b>ACMP1_I2</b> — Input 2 for comparator 1.
				I	<b>CT32B1_CAP2</b> — Capture input, channel 2 for 32-bit timer 1.
				O	<b>CT32B1_MAT2</b> — Match output, channel 2 for 32-bit timer 1.
SWCLK/ ACMP1_I3/ CT32B1_CAP3/ CT32B1_MAT3/PIO0_26	2 <sup>[6]</sup>	no	I; PU	I/O	<b>SWCLK</b> — Serial wire clock, default location.
				I	<b>ACMP1_I3</b> — Input 3 for comparator 1.
				I	<b>CT32B1_CAP3</b> — Capture input, channel 3 or 32-bit timer 1.
				O	<b>CT32B1_MAT3</b> — Match output, channel 3 for 32-bit timer 1.
PIO0_27/ACMP0_O	3 <sup>[7]</sup>	no	I; PU	I/O	<b>PIO0_27</b> — General purpose digital input/output pin (high-current output driver).
				O	<b>ACMP0_O</b> — Output for comparator 0.
PIO0_28/ACMP1_O/ CT16B0_CAP0/ CT16B0_MAT0	4 <sup>[7]</sup>	no	I; PU	I/O	<b>PIO0_28</b> — General purpose digital input/output pin (high-current output driver).
				O	<b>ACMP1_O</b> — Output for comparator 1.
				I	<b>CT16B0_CAP0</b> — Capture input, channel 0 for 16-bit timer 0.
PIO0_29/ROSC/ CT16B0_CAP1/ CT16B0_MAT1	5 <sup>[7]</sup>	no	I; PU	I/O	<b>PIO0_29</b> — General purpose digital input/output pin (high-current output driver).
				I/O	<b>ROSC</b> — Relaxation oscillator for 555 timer applications.
				I	<b>CT16B0_CAP1</b> — Capture input, channel 1 for 16-bit timer 0.
				O	<b>CT16B0_MAT1</b> — Match output, channel 1 for 16-bit timer 0.
R/PIO0_30/AD0	26 <sup>[5]</sup>	no	I; PU	I	<b>R</b> — Reserved. Configure for an alternate function in the IOCONFIG block.
				I/O	<b>PIO0_30</b> — General purpose digital input/output pin.
				I	<b>AD0</b> — A/D converter, input 0.
R/PIO0_31/AD1	27 <sup>[5]</sup>	no	I; PU	I	<b>R</b> — Reserved. Configure for an alternate function in the IOCONFIG block.
				I/O	<b>PIO0_31</b> — General purpose digital input/output pin.
				I	<b>AD1</b> — A/D converter, input 1.
PIO1_0 to PIO1_6				I/O	<b>Port 1</b> — Port 1 is a 32-bit I/O port with individual direction and function controls for each bit. The operation of port 1 pins depends on the function selected through the IOCONFIG register block. Pins PIO1_7 through PIO1_31 are not available.
R/PIO1_0/AD2	28 <sup>[5]</sup>	no	I; PU	O	<b>R</b> — Reserved. Configure for an alternate function in the IOCONFIG block.
				I/O	<b>PIO1_0</b> — General purpose digital input/output pin.
				I	<b>AD2</b> — A/D converter, input 2.

Table 3. LPC12D27 LQFP100 pin description ...continued

Symbol	Pin	Start logic input	Reset state	Type	Description
R/PIO1_1/AD3	80 <sup>[5]</sup>	no	I; PU	I	R — Reserved. Configure for an alternate function in the IOCONFIG block.
				I/O	PIO1_1 — General purpose digital input/output pin.
				I	AD3 — A/D converter, input 3.
PIO1_2/SWDIO/AD4	81 <sup>[5]</sup>	no	I; PU	I/O	PIO1_2 — General purpose digital input/output pin.
				I/O	SWDIO — Serial wire debug input/output, alternate location.
				I	AD4 — A/D converter, input 4.
PIO1_3/AD5/WAKEUP	82 <sup>[6]</sup>	no	I; PU	I/O	PIO1_3 — General purpose digital input/output pin.
				I	AD5 — A/D converter, input 5.
				I	WAKEUP — Deep power-down mode wake-up pin.
PIO1_4/AD6	83 <sup>[5]</sup>	no	I; PU	I/O	PIO1_4 — General purpose digital input/output pin.
				I	AD6 — A/D converter, input 6.
PIO1_5/AD7/ CT16B1_CAP0/ CT16B1_MAT0	84 <sup>[5]</sup>	no	I; PU	I/O	PIO1_5 — General purpose digital input/output pin.
				I	AD7 — A/D converter, input 7.
				I	CT16B1_CAP0 — Capture input, channel 0 for 16-bit timer 1.
				O	CT16B1_MAT0 — Match output, channel 0 for 16-bit timer 1.
PIO1_6/CT16B1_CAP1/ CT16B1_MAT1	85 <sup>[2]</sup>	no	I; PU	I/O	PIO1_6 — General purpose digital input/output pin.
				I	CT16B1_CAP1 — Capture input, channel 1 for 16-bit timer 1.
				O	CT16B1_MAT1 — Match output, channel 1 for 16-bit timer 1.
PIO2_0				I/O	Port 2 — Port 2 is a 32-bit I/O port with individual direction and function controls for each bit. The operation of port 2 pins depends on the function selected through the IOCONFIG register block. Pins PIO2_1 through PIO2_31 are not available.
PIO2_0/CT16B0_CAP0/ CT16B0_MAT0	16 <sup>[2]</sup>	no	I; PU	I/O	PIO2_0 — General purpose digital input/output pin.
				I	CT16B0_CAP0 — Capture input, channel 0 for 16-bit timer 0.
				O	CT16B0_MAT0 — Match output, channel 0 for 16-bit timer 0.
RTCXIN	89	-	-	-	Input to the 32 kHz oscillator circuit.
RTCXOUT	88	-	-	-	Output from the 32 kHz oscillator amplifier.
XTALIN	92	-	-	-	Input to the system oscillator circuit and internal clock generator circuits.
XTALOUT	93	-	-	-	Output from the system oscillator amplifier.
VREF_CMP	94	-	-	-	Reference voltage for comparator.
V <sub>DD(I/O)</sub>	90	-	-	-	Input/output supply voltage.
V <sub>DD(3V3)</sub>	87	-	-	-	3.3 V supply voltage to the internal regulator and the ADC. Also used as the ADC reference voltage.
V <sub>SSIO</sub>	91	-	-	-	Ground.
V <sub>SS</sub>	86	-	-	-	Ground.
<b>LCD display pins</b>					
S0	46	-	V <sub>LCD</sub> <sup>[8]</sup>	O	LCD segment output.
S1	47	-	V <sub>LCD</sub> <sup>[8]</sup>	O	LCD segment output.

Table 3. LPC12D27 LQFP100 pin description ...continued

Symbol	Pin	Start logic input	Reset state <a href="#">[1]</a>	Type	Description
S2	48	-	V <sub>LCD</sub> <a href="#">[8]</a>	O	LCD segment output.
S3	49	-	V <sub>LCD</sub> <a href="#">[8]</a>	O	LCD segment output.
S4	50	-	V <sub>LCD</sub> <a href="#">[8]</a>	O	LCD segment output.
S5	51	-	V <sub>LCD</sub> <a href="#">[8]</a>	O	LCD segment output.
S6	52	-	V <sub>LCD</sub> <a href="#">[8]</a>	O	LCD segment output.
S7	53	-	V <sub>LCD</sub> <a href="#">[8]</a>	O	LCD segment output.
S8	54	-	V <sub>LCD</sub> <a href="#">[8]</a>	O	LCD segment output.
S9	55	-	V <sub>LCD</sub> <a href="#">[8]</a>	O	LCD segment output.
S10	56	-	V <sub>LCD</sub> <a href="#">[8]</a>	O	LCD segment output.
S11	57	-	V <sub>LCD</sub> <a href="#">[8]</a>	O	LCD segment output.
S12	58	-	V <sub>LCD</sub> <a href="#">[8]</a>	O	LCD segment output.
S13	59	-	V <sub>LCD</sub> <a href="#">[8]</a>	O	LCD segment output.
S14	60	-	V <sub>LCD</sub> <a href="#">[8]</a>	O	LCD segment output.
S15	61	-	V <sub>LCD</sub> <a href="#">[8]</a>	O	LCD segment output.
S16	62	-	V <sub>LCD</sub> <a href="#">[8]</a>	O	LCD segment output.
S17	63	-	V <sub>LCD</sub> <a href="#">[8]</a>	O	LCD segment output.
S18	64	-	V <sub>LCD</sub> <a href="#">[8]</a>	O	LCD segment output.
S19	65	-	V <sub>LCD</sub> <a href="#">[8]</a>	O	LCD segment output.
S20	66	-	V <sub>LCD</sub> <a href="#">[8]</a>	O	LCD segment output.
S21	67	-	V <sub>LCD</sub> <a href="#">[8]</a>	O	LCD segment output.
S22	68	-	V <sub>LCD</sub> <a href="#">[8]</a>	O	LCD segment output.
S23	69	-	V <sub>LCD</sub> <a href="#">[8]</a>	O	LCD segment output.
S24	70	-	V <sub>LCD</sub> <a href="#">[8]</a>	O	LCD segment output.
S25	71	-	V <sub>LCD</sub> <a href="#">[8]</a>	O	LCD segment output.
S26	72	-	V <sub>LCD</sub> <a href="#">[8]</a>	O	LCD segment output.
S27	73	-	V <sub>LCD</sub> <a href="#">[8]</a>	O	LCD segment output.
S28	74	-	V <sub>LCD</sub> <a href="#">[8]</a>	O	LCD segment output.
S29	75	-	V <sub>LCD</sub> <a href="#">[8]</a>	O	LCD segment output.
S30	76	-	V <sub>LCD</sub> <a href="#">[8]</a>	O	LCD segment output.
S31	77	-	V <sub>LCD</sub> <a href="#">[8]</a>	O	LCD segment output.
S32	78	-	V <sub>LCD</sub> <a href="#">[8]</a>	O	LCD segment output.
S33	79	-	V <sub>LCD</sub> <a href="#">[8]</a>	O	LCD segment output.
S34	29	-	V <sub>LCD</sub> <a href="#">[8]</a>	O	LCD segment output.
S35	30	-	V <sub>LCD</sub> <a href="#">[8]</a>	O	LCD segment output.
S36	31	-	V <sub>LCD</sub> <a href="#">[8]</a>	O	LCD segment output.
S37	32	-	V <sub>LCD</sub> <a href="#">[8]</a>	O	LCD segment output.
S38	33	-	V <sub>LCD</sub> <a href="#">[8]</a>	O	LCD segment output.
S39	34	-	V <sub>LCD</sub> <a href="#">[8]</a>	O	LCD segment output.
BP0	42	-	V <sub>LCD</sub> <a href="#">[8]</a>	O	LCD backplane output.

Table 3. LPC12D27 LQFP100 pin description ...continued

Symbol	Pin	Start logic input	Reset state	Type	Description
BP1	44	-	V <sub>LCD</sub> [8]	O	LCD backplane output.
BP2	43	-	V <sub>LCD</sub> [8]	O	LCD backplane output.
BP3	45	-	V <sub>LCD</sub> [8]	O	LCD backplane output.
LCD_SDA	35	-	[8]	I/O	I <sup>2</sup> C-bus serial data input/output.
LCD_SCL	36	-	[8]	I/O	I <sup>2</sup> C-bus serial clock input.
SYNC	37	-	[8]	I/O	Cascade synchronization input/output.
CLK	38	-	[8]	I/O	External clock input/output.
V <sub>DD</sub>	39	-	-	-	1.8 V to 5.5 V power supply: Power supply voltage for the PCF8576D.
V <sub>SS(LCD)</sub>	40	-	-	-	LCD ground.
V <sub>LCD</sub>	41	-	-	-	LCD power supply: LCD voltage.

[1] Pin state at reset for default function: I = Input; O = Output; PU = internal pull-up enabled; IA = inactive, no pull-up/down enabled.

[2] Digital I/O pin; default: pull-up enabled, no hysteresis.

[3] I<sup>2</sup>C-bus pins; 5 V tolerant; open-drain; default: no pull-up/pull-down, no hysteresis.

[4] Digital I/O pin with RESET function; default: pull-up enabled, no hysteresis.

[5] Digital I/O pin with analog function; default: pull-up enabled, no hysteresis.

[6] Digital I/O pin with analog function and WAKEUP function; default: pull-up enabled, no hysteresis.

[7] High-drive digital I/O pin; default: pull-up enabled, no hysteresis.

[8] See [Section 7.2.3](#).

## 7. Functional description

### 7.1 LPC1227 microcontroller

See the *LPC122x data sheet* for a detailed functional description of the LPC1227 microcontroller.

### 7.2 LCD driver

See the *PCF8576 data sheet* for a detailed functional description of the PCF8576D LCD driver.

#### 7.2.1 General description

The PCF8576D is a peripheral device which interfaces to almost any Liquid Crystal Display (LCD) with low multiplex rates. It generates the drive signals for any static or multiplexed LCD containing up to four backplanes and up to 40 segments. It can be easily cascaded for larger LCD applications. The PCF8576D communicates via the two-line bidirectional I<sup>2</sup>C-bus. Communication overheads are minimized by a display RAM with auto-incremented addressing, by hardware subaddressing and by display memory switching (static and duplex drive modes). Please refer to *PCF8576D data sheet* for electrical data.

7.2.2 Functional description

The PCF8576D is a versatile peripheral device interfacing the LPC1227 microcontroller with a wide variety of LCDs. It can directly drive any static or multiplexed LCD containing up to four backplanes and up to 40 segments.

The possible display configurations of the PCF8576D depend on the number of active backplane outputs required. A selection of display configurations is shown in [Table 4](#). The integration of the LPC1227 microcontroller with the PCF8576D is shown in [Figure 1](#).

Table 4. Selection of display configurations

Number of Backplanes	Segments	Digits/Characters		
		7-segment	14-segment	Dot matrix/Elements
4	160	20	10	160 (4 × 40)
3	120	15	7	120 (3 × 40)
2	80	10	5	64 (2 × 40)
1	40	5	2	40 (1 × 40)

7.2.3 Reset state of the LCD controller and pins

After power-on, the LCD controller resets to the following starting conditions:

- All backplane and segment outputs are set to  $V_{LCD}$ .
- The selected drive mode is 1:4 multiplex with 1/3 bias.
- Blinking is switched off.
- Input and output bank selectors are reset.
- The I<sup>2</sup>C-bus interface is initialized.
- The data pointer and the subaddress counter are cleared (set to logic 0).
- The display is disabled.

**Remark:** Do not transfer data on the I<sup>2</sup>C-bus for at least 1 ms after a power-on to allow the reset action to complete.

7.2.4 LCD bias generator

Fractional LCD biasing voltages are obtained from an internal voltage divider consisting of three impedances connected in series between  $V_{LCD}$  and  $V_{SS(LCD)}$ . The middle resistor can be bypassed to provide a 1/2 bias voltage level for the 1:2 multiplex configuration. The LCD voltage can be temperature compensated externally using the supply to pin  $V_{LCD}$ .

7.2.5 Oscillator

7.2.5.1 Internal clock

The internal logic of the PCF8576D and its LCD drive signals are timed either by its internal oscillator or by an external clock. The internal oscillator is enabled by connecting pin OSC to pin  $V_{SS(LCD)}$ . If the internal oscillator is used, the output from pin CLK can be used as the clock signal for several PCF8576Ds in the system that are connected in cascade.



### 7.2.6 Timing

The PCF8576D timing controls the internal data flow of the device. This includes the transfer of display data from the display RAM to the display segment outputs. In cascaded applications, the correct timing relationship between each PCF8576D in the system is maintained by the synchronization signal at pin  $\overline{\text{SYNC}}$ . The timing also generates the LCD frame signal whose frequency is derived from the clock frequency. The frame signal frequency ( $f_{\text{fr}}$ ) is a fixed division of the clock frequency ( $f_{\text{clk}}$ ) from either the internal or an external clock:  $f_{\text{fr}} = f_{\text{clk}}/24$ .

### 7.2.7 Display register

A display latch holds the display data while the corresponding multiplex signals are generated. There is a one-to-one relationship between the data in the display latch, the LCD segment outputs, and each column of the display RAM.

### 7.2.8 Segment outputs

The LCD drive section includes 40 segment outputs S0 to S39 which should be connected directly to the LCD. The segment output signals are generated in accordance with the multiplexed backplane signals and with data residing in the display latch. When less than 40 segment outputs are required, the unused segment outputs should be left open-circuit.

### 7.2.9 Backplane outputs

The LCD drive section includes four backplane outputs BP0 to BP3 which must be connected directly to the LCD. The backplane output signals are generated in accordance with the selected LCD drive mode. If less than four backplane outputs are required, the unused outputs can be left open-circuit.

In the 1:3 multiplex drive mode, BP3 carries the same signal as BP1, therefore these two adjacent outputs can be tied together to give enhanced drive capabilities.

In the 1:2 multiplex drive mode, BP0 and BP2, BP1 and BP3 all carry the same signals and may also be paired to increase the drive capabilities.

In the static drive mode the same signal is carried by all four backplane outputs and they can be connected in parallel for very high drive requirements.

### 7.2.10 Display RAM

The display RAM is a static  $40 \times 4$ -bit RAM which stores LCD data. There is a one-to-one correspondence between the RAM addresses and the segment outputs, and between the individual bits of a RAM word and the backplane outputs. For details, see *PCF8576D data sheet*.



## 8. Limiting values

**Table 5. Limiting values**

In accordance with the Absolute Maximum Rating System (IEC 60134).<sup>[1]</sup>

Symbol	Parameter	Conditions	Min	Max	Unit
$V_{DD(3V3)}$	supply voltage (3.3 V)		3.0	3.6	V
$V_{DD(I/O)}$	input/output supply voltage		3.0	3.6	V
$V_I$	input voltage	on all digital pins	<sup>[2]</sup> -0.5	+3.6	V
		on pins PIO0_10 and PIO0_11 (I <sup>2</sup> C-bus pins)	0	5.5	V
$I_{DD}$	supply current	per supply pin	<sup>[3]</sup> -	100	mA
$I_{SS}$	ground current	per ground pin	<sup>[3]</sup> -	100	mA
$I_{latch}$	I/O latch-up current	$-(0.5V_{DD}) < V_I < (1.5V_{DD})$ ; $T_j < 125\text{ }^\circ\text{C}$	-	100	mA
$T_{stg}$	storage temperature		<sup>[4]</sup> -65	+150	$^\circ\text{C}$
$P_{tot(pack)}$	total power dissipation (per package)	based on package heat transfer, not device power consumption	-	1.5	W
$V_{ESD}$	electrostatic discharge voltage	human body model; all pins	<sup>[5]</sup> -8000	+8000	V

[1] The following applies to the limiting values:

- a) This product includes circuitry specifically designed for the protection of its internal devices from the damaging effects of excessive static charge. Nonetheless, it is suggested that conventional precautions be taken to avoid applying greater than the rated maximum.
- b) Parameters are valid over operating temperature range unless otherwise specified. All voltages are with respect to  $V_{SS}$  unless otherwise noted.

[2] Including voltage on outputs in 3-state mode.

[3] The peak current is limited to 25 times the corresponding maximum current.

[4] Dependent on package type.

[5] Human body model: equivalent to discharging a 100 pF capacitor through a 1.5 k $\Omega$  series resistor.

## 9. Thermal characteristics

### 9.1 Thermal characteristics

The average chip junction temperature,  $T_j$  (°C), can be calculated using the following equation:

$$T_j = T_{amb} + (P_D \times R_{th(j-a)}) \quad (1)$$

- $T_{amb}$  = ambient temperature (°C),
- $R_{th(j-a)}$  = the package junction-to-ambient thermal resistance (°C/W)
- $P_D$  = sum of internal and I/O power dissipation

The internal power dissipation is the product of  $I_{DD}$  and  $V_{DD}$ . The I/O power dissipation of the I/O pins is often small and many times can be negligible. However it can be significant in some applications.

**Table 6. Thermal characteristics**

$V_{DD} = 3.0\text{ V to }3.6\text{ V}$ ;  $T_{amb} = -40\text{ °C to }+85\text{ °C unless otherwise specified.}$

Symbol	Parameter	Conditions	Min	Typ	Max	Unit
$R_{th(j-a)}$	thermal resistance from junction to ambient	JEDEC test board; no air flow	-	61	-	°C/W
		LQFP64 package				
		LQFP48 package		86	-	°C/W
$R_{th(j-c)}$	thermal resistance from junction to case	JEDEC test board	-	19	-	°C/W
		LQFP64 package				
		LQFP48 package		36	-	°C/W
$T_{j(max)}$	maximum junction temperature		-	-	150	°C

## 10. Static characteristics

**Table 7. Static characteristics**

$T_{amb} = -40\text{ }^{\circ}\text{C}$  to  $+85\text{ }^{\circ}\text{C}$ , unless otherwise specified.

Symbol	Parameter	Conditions	Min	Typ <sup>[1]</sup>	Max	Unit
$V_{DD(I/O)}$	input/output supply voltage	on pin $V_{DD(I/O)}$	3.0	3.3	3.6	V
$V_{DD(3V3)}$	supply voltage (3.3 V)		3.0	3.3	3.6	V
$I_{DD}$	supply current	Active mode; $V_{DD(3V3)} = 3.3\text{ V}$ ; $T_{amb} = 25\text{ }^{\circ}\text{C}$ ; code while(1){} executed from flash				
		all peripherals disabled:				
		CCLK = 12 MHz	-	4.6	-	mA
		CCLK = 24 MHz	-	9	-	mA
		CCLK = 33 MHz	-	12.2	-	mA
		all peripherals enabled:				
		CCLK = 12 MHz	-	6.6	-	mA
		CCLK = 24 MHz	-	10.9	-	mA
		CCLK = 33 MHz	-	14.1	-	mA
		Sleep mode; $V_{DD(3V3)} = 3.3\text{ V}$ ; $T_{amb} = 25\text{ }^{\circ}\text{C}$ ; all peripherals disabled				
		CCLK = 12 MHz	-	1.8	-	mA
		CCLK = 24 MHz	-	3.3	-	mA
		CCLK = 33 MHz	-	4.4	-	mA
		Deep-sleep mode; $V_{DD(3V3)} = 3.3\text{ V}$ ; $T_{amb} = 25\text{ }^{\circ}\text{C}$	-	30	-	$\mu\text{A}$
		Deep power-down mode; $V_{DD(3V3)} = 3.3\text{ V}$ ; $T_{amb} = 25\text{ }^{\circ}\text{C}$	-	720	-	nA
<b>Normal-drive output pins (Standard port pins, RESET)</b>						
$I_{IL}$	LOW-level input current	$V_I = 0\text{ V}$ ;	-	-	100	nA
$I_{IH}$	HIGH-level input current	$V_I = V_{DD(I/O)}$ ;	-	-	100	nA
$I_{OZ}$	OFF-state output current	$V_O = 0\text{ V}$ ; $V_O = V_{DD(I/O)}$ ;	-	-	100	nA
$V_I$	input voltage	pin configured to provide a digital function	<a href="#">[2]</a> <a href="#">[3]</a> <a href="#">[4]</a> 0	-	$V_{DD(I/O)}$	V
$V_O$	output voltage	output active	0	-	$V_{DD(I/O)}$	V
$V_{IH}$	HIGH-level input voltage		$0.7V_{DD(I/O)}$	-	-	V

**Table 7. Static characteristics ...continued**  
 $T_{amb} = -40\text{ }^{\circ}\text{C}$  to  $+85\text{ }^{\circ}\text{C}$ , unless otherwise specified.

Symbol	Parameter	Conditions	Min	Typ <sup>[1]</sup>	Max	Unit
$V_{IL}$	LOW-level input voltage		-	-	$0.3V_{DD(IO)}$	V
$V_{hys}$	hysteresis voltage		-	0.4	-	V
$V_{OH}$	HIGH-level output voltage	low mode; $I_{OH} = -2\text{ mA}$	$V_{DD(IO)} - 0.4$	-	-	V
		high mode; $I_{OH} = -4\text{ mA}$	$V_{DD(IO)} - 0.4$	-	-	V
$V_{OL}$	LOW-level output voltage	low mode; $I_{OL} = 2\text{ mA}$	-	-	0.4	V
		high mode; $I_{OL} = 4\text{ mA}$	-	-	0.4	V
$I_{OH}$	HIGH-level output current	low mode; $V_{OH} = V_{DD(IO)} - 0.4\text{ V}$	-2	-	-	mA
		high mode; $V_{OH} = V_{DD(IO)} - 0.4\text{ V}$	-4	-	-	mA
$I_{OL}$	LOW-level output current	low mode; $V_{OL} = 0.4\text{ V}$	2	-	-	mA
		high mode; $V_{OL} = 0.4\text{ V}$	4	-	-	mA
$I_{OHS}$	HIGH-level short-circuit output current	$V_{OH} = 0\text{ V}$	<sup>[5]</sup> -	-	-45	mA
$I_{OLS}$	LOW-level short-circuit output current	$V_{OL} = V_{DDA}$	<sup>[5]</sup> -	-	50	mA
$I_{pu}$	pull-up current	$V_I = 0\text{ V}$	-50	-80	-100	$\mu\text{A}$
<b>High-drive output pins (PIO0_27, PIO0_28, PIO0_29, PIO0_12)</b>						
$I_{IL}$	LOW-level input current	$V_I = 0\text{ V};$	-	-	100	nA
$I_{IH}$	HIGH-level input current	$V_I = V_{DD(IO)};$	-	-	100	nA
$I_{OZ}$	OFF-state output current	$V_O = 0\text{ V}; V_O = V_{DD(IO)};$	-	-	100	nA
$V_I$	input voltage	pin configured to provide a digital function	<sup>[2][3]</sup> 0 <sup>[4]</sup>	-	$V_{DD(IO)}$	V
$V_O$	output voltage	output active	0	-	$V_{DD(IO)}$	V
$V_{IH}$	HIGH-level input voltage		$0.7V_{DD(IO)}$	-	-	V
$V_{IL}$	LOW-level input voltage		-	$0.3V_{DD(IO)}$	-	-
$V_{hys}$	hysteresis voltage		-	-	-	V
$V_{OH}$	HIGH-level output voltage	low mode; $I_{OH} = -20\text{ mA}$	$V_{DD(IO)} - 0.7$	-	-	V
		high mode; $I_{OH} = -28\text{ mA}$	$V_{DD(IO)} - 0.7$	-	-	V
$V_{OL}$	LOW-level output voltage	low mode; $I_{OL} = 12\text{ mA}$	-	-	0.4	V
		high mode; $I_{OL} = 18\text{ mA}$	-	-	0.4	V

**Table 7. Static characteristics ...continued**  
 $T_{amb} = -40\text{ }^{\circ}\text{C}$  to  $+85\text{ }^{\circ}\text{C}$ , unless otherwise specified.

Symbol	Parameter	Conditions	Min	Typ <sup>[1]</sup>	Max	Unit
$I_{OH}$	HIGH-level output current	low mode; $V_{OH} = V_{DD(IO)} - 0.7$	20	-	-	mA
		high mode; $V_{OH} = V_{DD(IO)} - 0.7$	28	-	-	mA
$I_{OL}$	LOW-level output current	$V_{OL} = 0.4\text{ V}$ low mode	12	-	-	mA
		high mode	18	-	-	mA
$I_{OLS}$	LOW-level short-circuit output current	$V_{OL} = V_{DD}$	<sup>[5]</sup> -	-	-	mA
$I_{pu}$	pull-up current	$V_I = 0\text{ V}$	-50	-80	-100	$\mu\text{A}$
<b>I<sup>2</sup>C-bus pins (PIO0_10 and PIO0_11)</b>						
$V_{IH}$	HIGH-level input voltage		$0.7V_{DD(IO)}$	-	-	V
$V_{IL}$	LOW-level input voltage		-	-	$0.3V_{DD(IO)}$	V
$V_{hys}$	hysteresis voltage		-	$0.05V_{DD(IO)}$	-	V
$V_{OL}$	LOW-level output voltage	$I_{OLS} = 20\text{ mA}$	-	-	0.4	V
$I_{LI}$	input leakage current	$V_I = V_{DD(IO)}$	<sup>[6]</sup> -	2	4	$\mu\text{A}$
		$V_I = 5\text{ V}$	-	10	22	$\mu\text{A}$
$C_i$	capacitance for each I/O pin	on pins PIO0_10 and PIO0_11	-	-	8	pF
<b>Oscillator pins</b>						
$V_{i(xtal)}$	crystal input voltage	see <a href="#">Section 12.1</a>	0	1.8	1.95	V
$V_{o(xtal)}$	crystal output voltage		0	1.8	1.95	V

- [1] Typical ratings are not guaranteed. The values listed are at room temperature (25 °C), nominal supply voltages.  
 [2] Including voltage on outputs in 3-state mode.  
 [3]  $V_{DD(3V3)}$  and  $V_{DD(IO)}$  supply voltages must be present.  
 [4] 3-state outputs go into 3-state mode when  $V_{DD(IO)}$  is grounded.  
 [5] Allowed as long as the current limit does not exceed the maximum current allowed by the device.  
 [6] To  $V_{SS}$ .

## 10.1 Peripheral power consumption

The supply current per peripheral is measured as the difference in supply current between the peripheral block enabled and the peripheral block disabled in the SYSAHBCLKCFG and PDRUNCFG (for analog blocks) registers. All other blocks are disabled in both registers and no code is executed. Measured on a typical sample at  $T_{amb} = 25\text{ °C}$  and  $V_{DD(3V3)} = 3.3\text{ V}$ .

**Table 8. Peripheral power consumption**

Peripheral	Typical current consumption $I_{DD}$ in mA	Frequency independent			
		24 MHz system oscillator + PLL	IRC + PLL	12 MHz system oscillator	IRC
IRC	0.29	-	-	-	-
PLL (PLL output frequency = 24 MHz)	1.87	-	-	-	-
WDosc (WDosc output frequency = 500 kHz)	0.25	-	-	-	-
BOD	0.06	-	-	-	-
Analog comparator 0/1	-	0.05	0.05	0.03	0.02
ADC	-	1.86	1.85	1.61	1.61
CRC engine	-	0.04	0.04	0.02	0.02
16-bit timer 0 (CT16B0)	-	0.09	0.09	0.04	0.04
16-bit timer 1 (CT16B1)	-	0.09	0.09	0.04	0.04
32-bit timer 0 (CT32B0)	-	0.08	0.08	0.04	0.04
32-bit timer 1 (CT32B1)	-	0.08	0.08	0.04	0.04
GPIO0	-	0.34	0.34	0.17	0.17
GPIO1	-	0.34	0.34	0.17	0.17
GPIO2	-	0.36	0.37	0.18	0.18
I2C	-	0.09	0.09	0.05	0.05
IOCON	-	0.09	0.10	0.05	0.05
RTC	-	0.10	0.10	0.05	0.05
SSP	-	0.30	0.29	0.15	0.15
UART0	-	0.52	0.51	0.26	0.26
UART1	-	0.52	0.51	0.26	0.26
DMA	-	0.18	0.18	0.09	0.09
WWDT	-	0.06	0.06	0.03	0.03

## 10.2 Power consumption

Power measurements in Active, Sleep, and Deep-sleep modes were performed under the following conditions (see *LPC122x user manual*):

- Active mode: all GPIO pins set to input with external pull-up resistors.
- Sleep and Deep-sleep modes: all GPIO pins set to output driving LOW.
- Deep power-down mode: all GPIO pins set to input with external pull-up resistors.

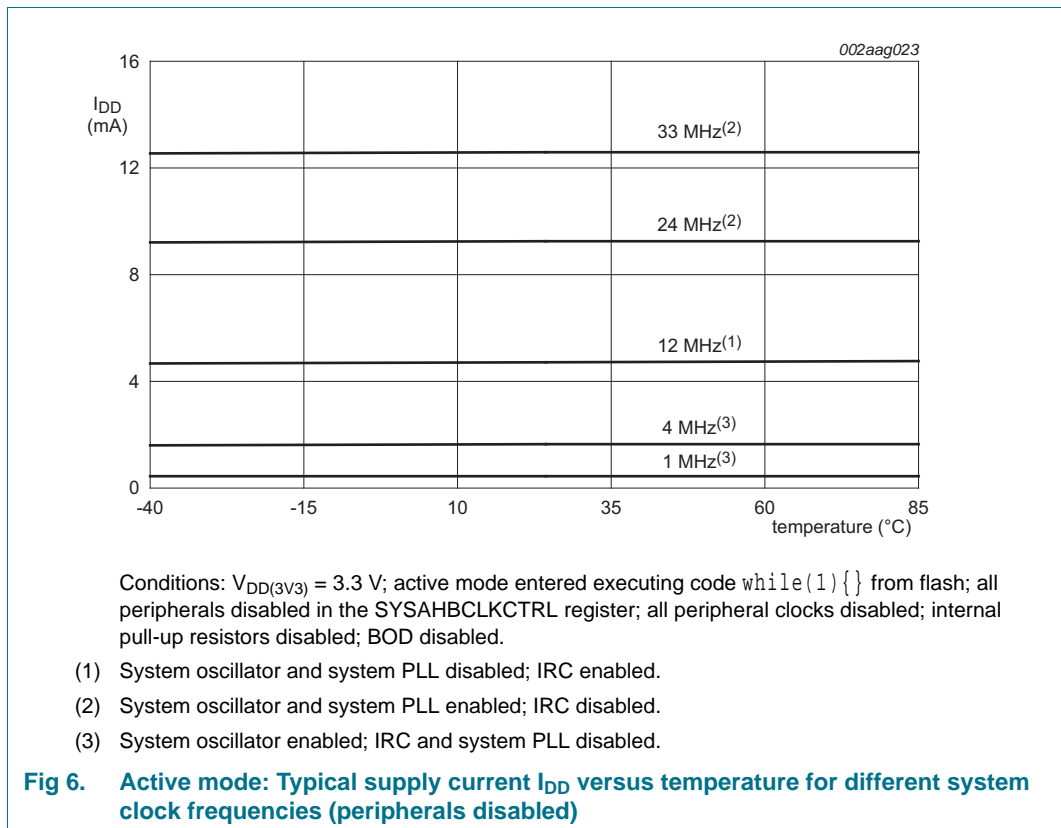
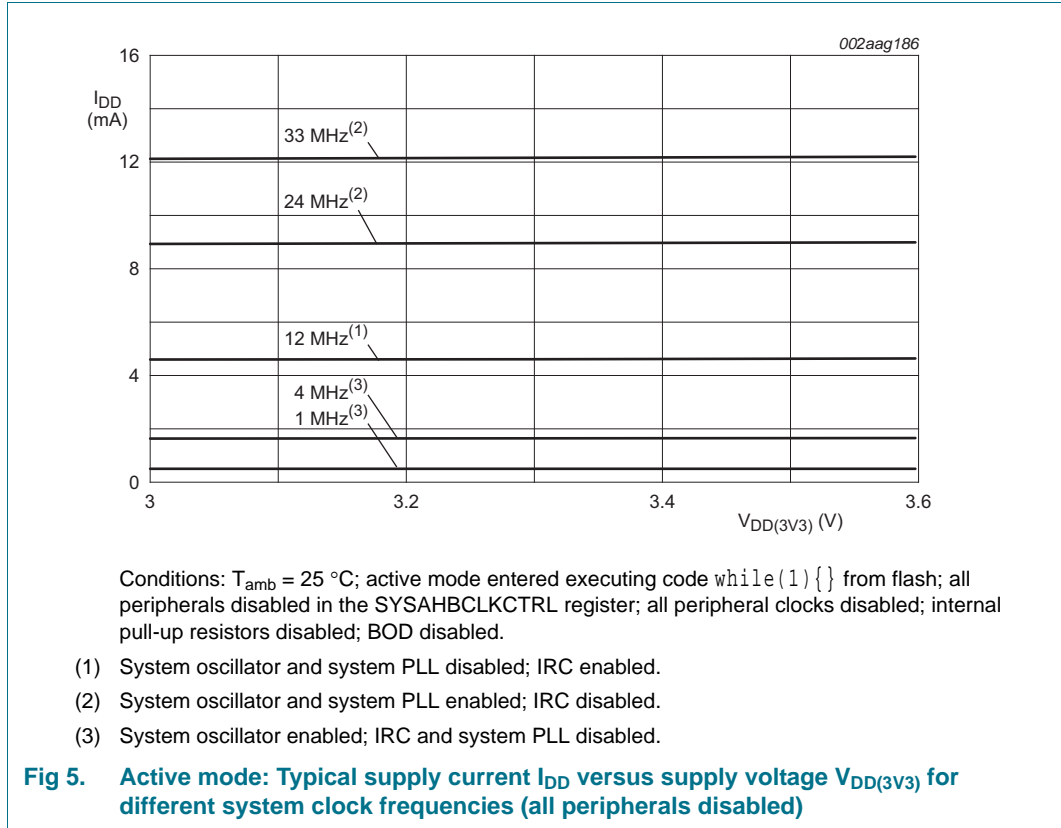

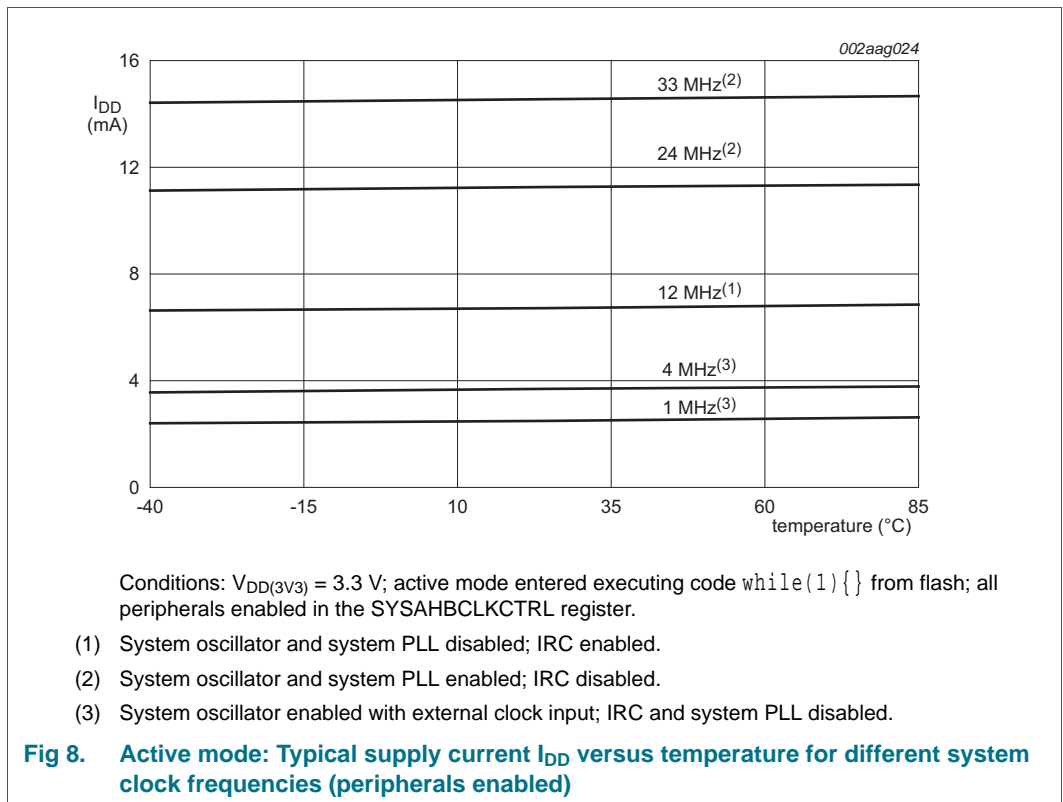
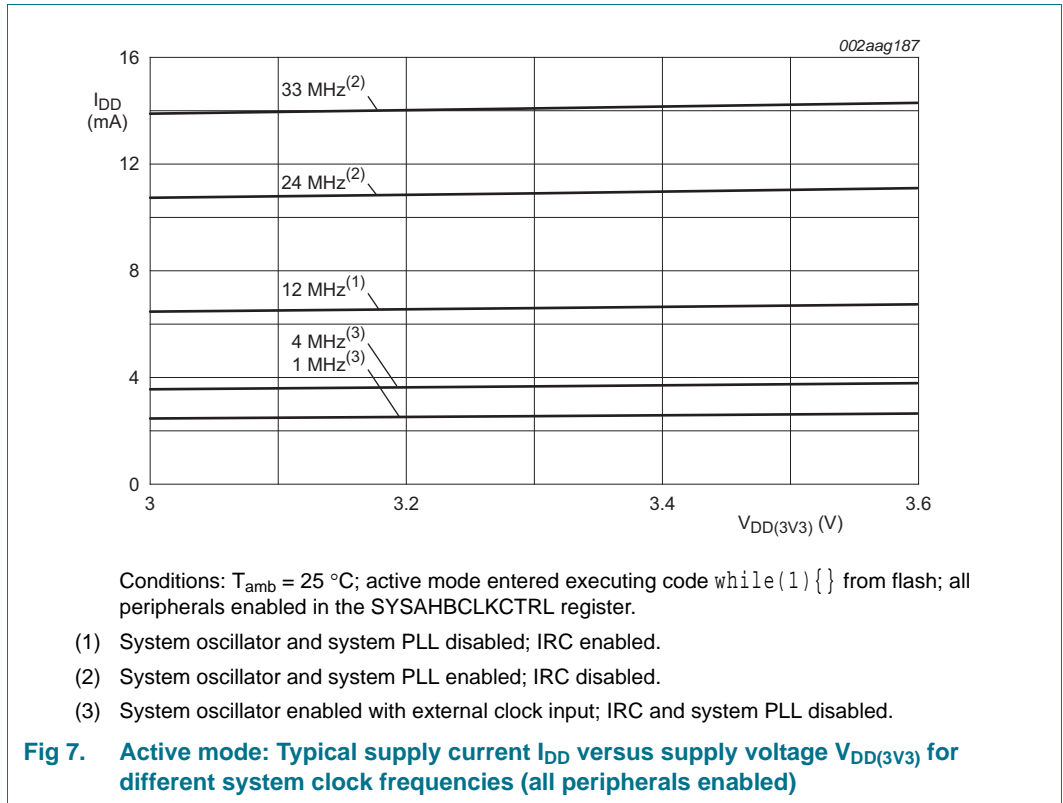



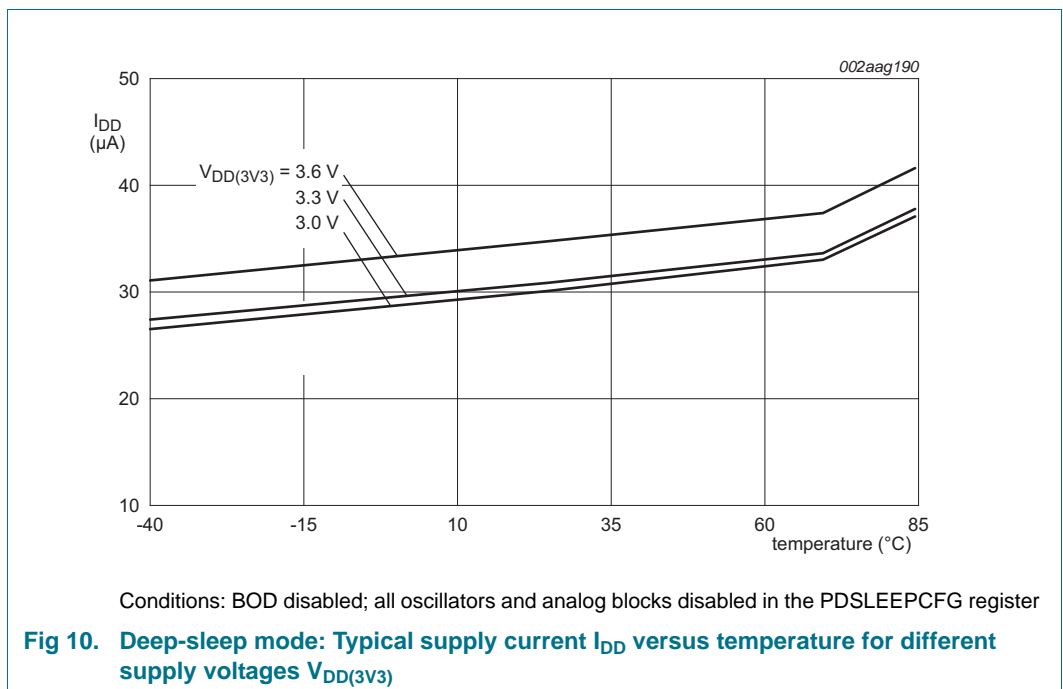
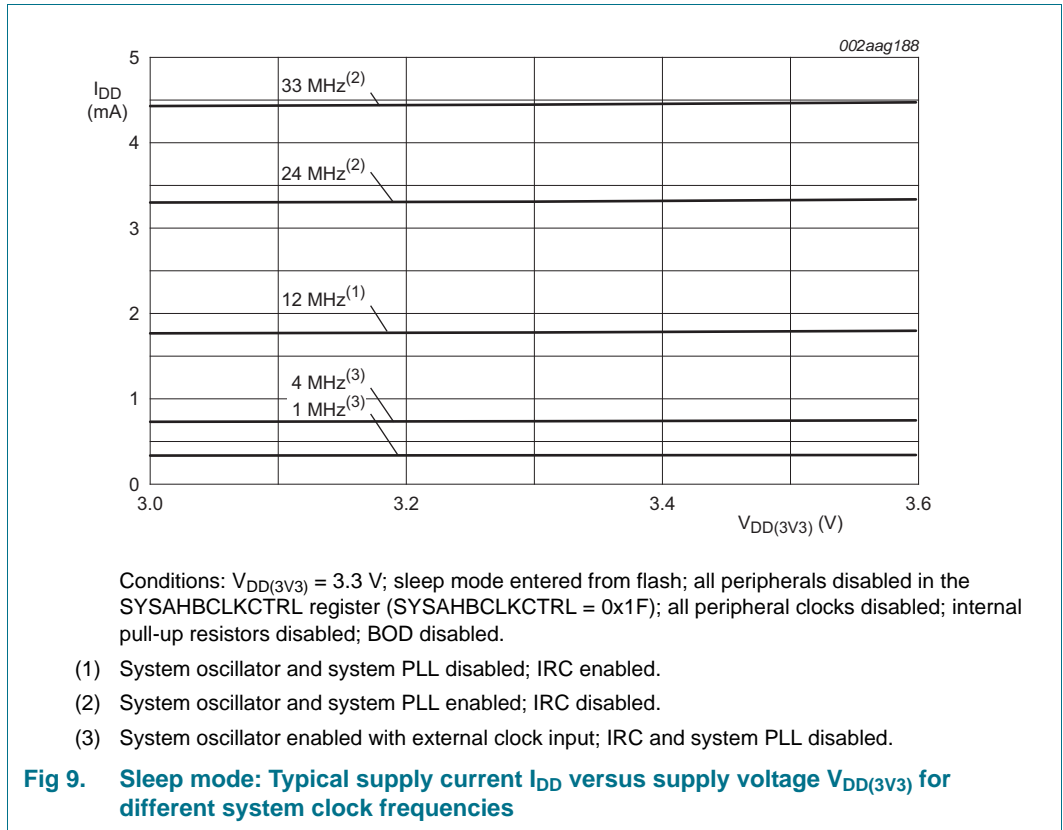

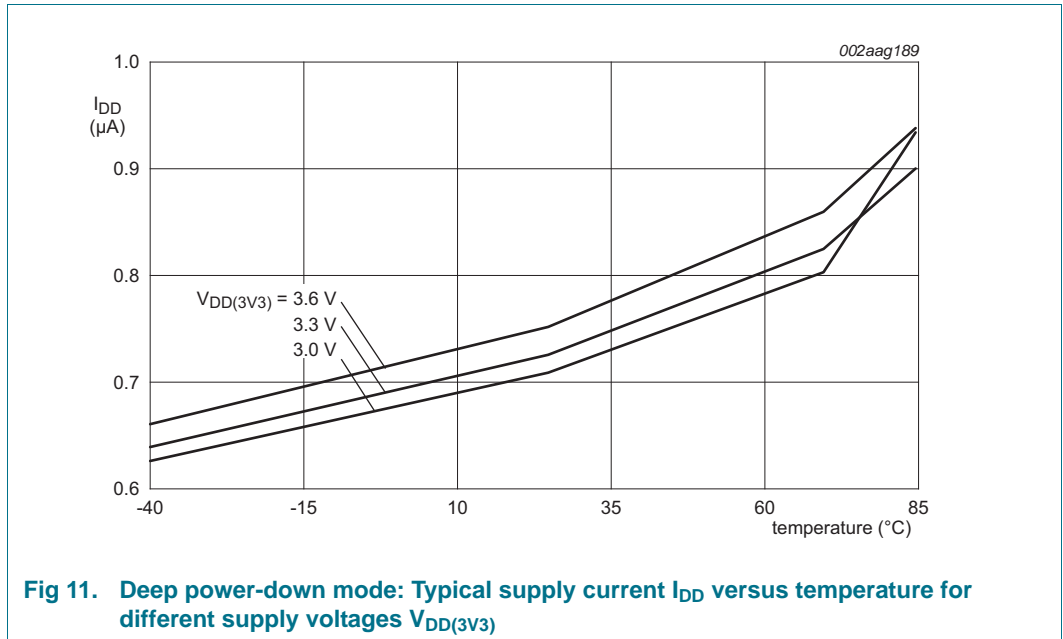

### 10.3 Electrical pin characteristics

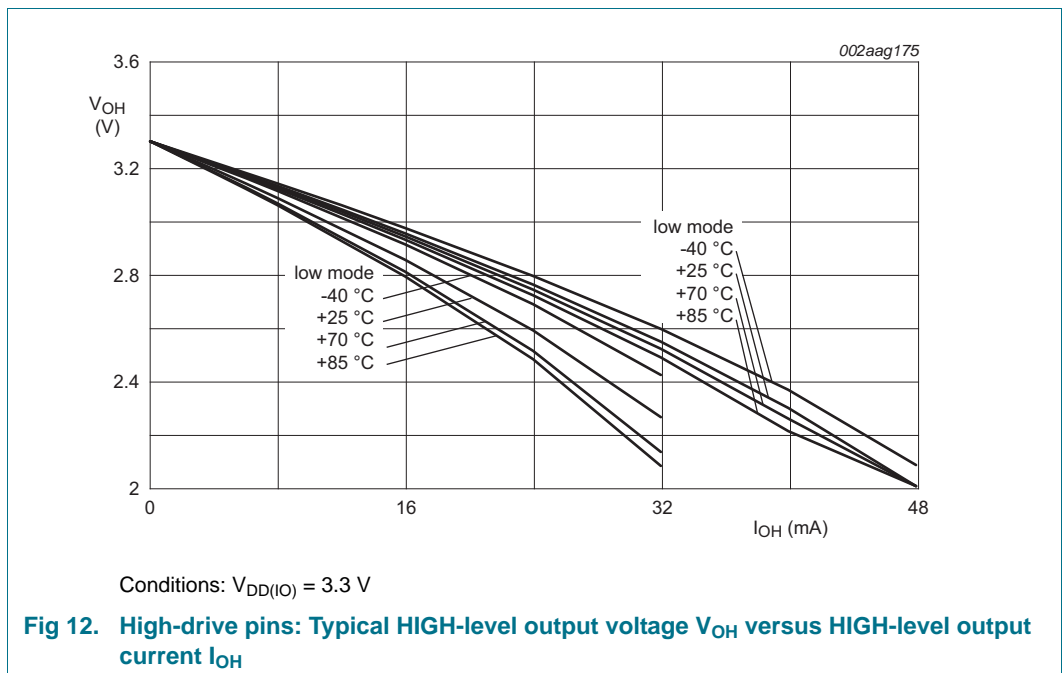

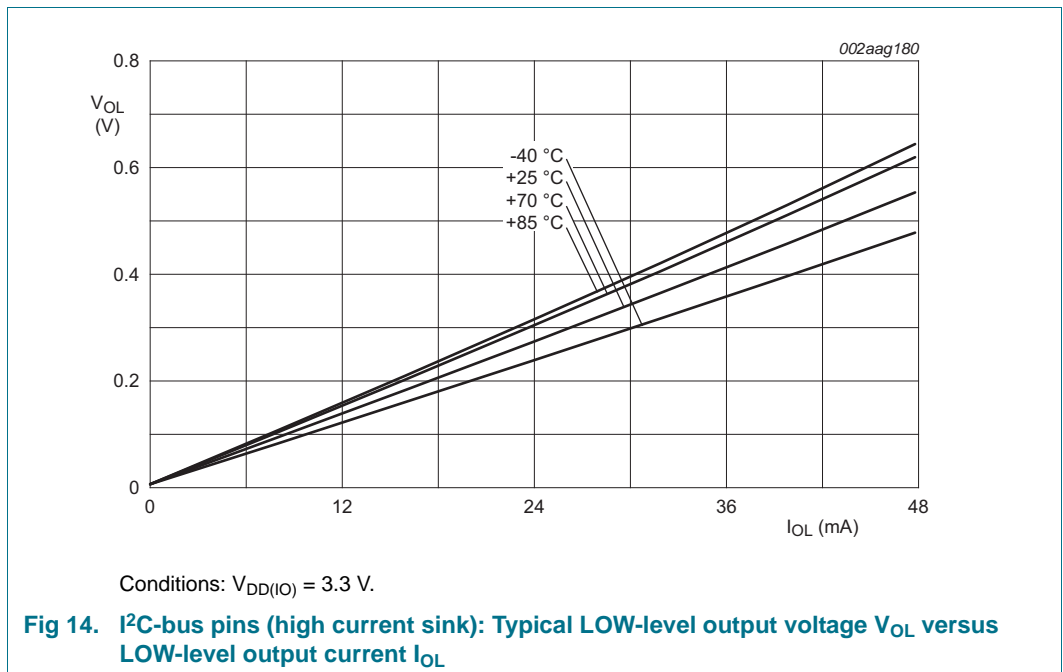
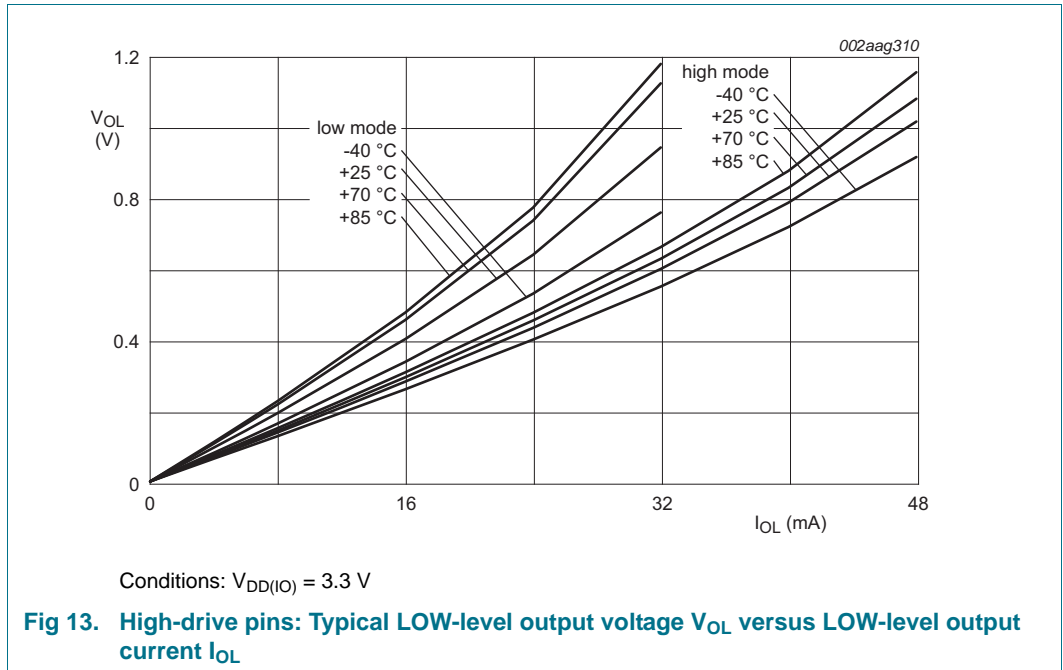

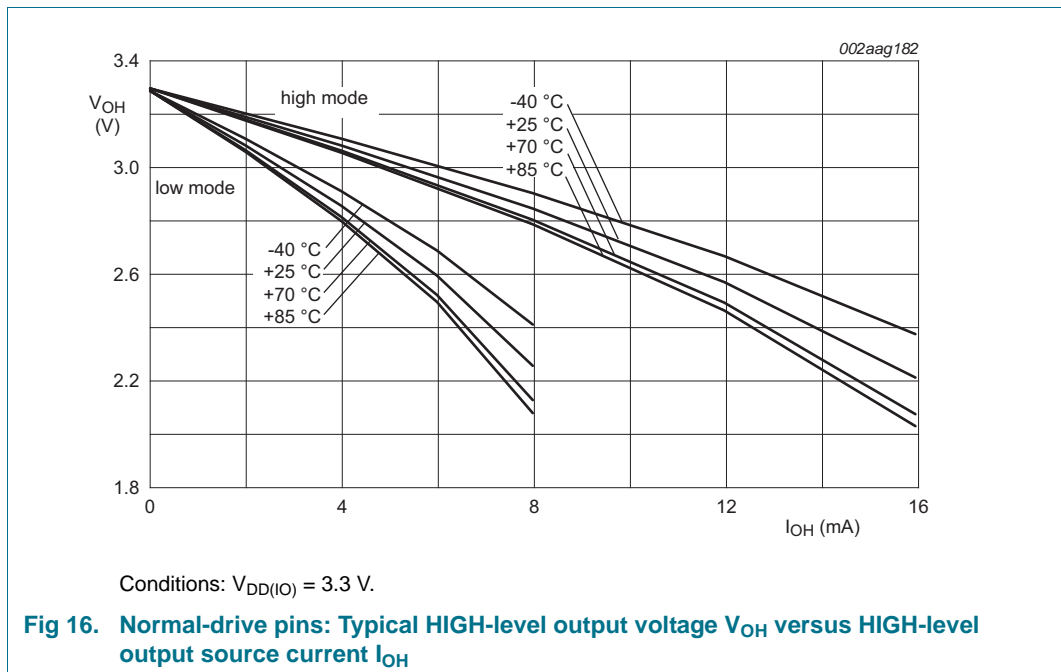
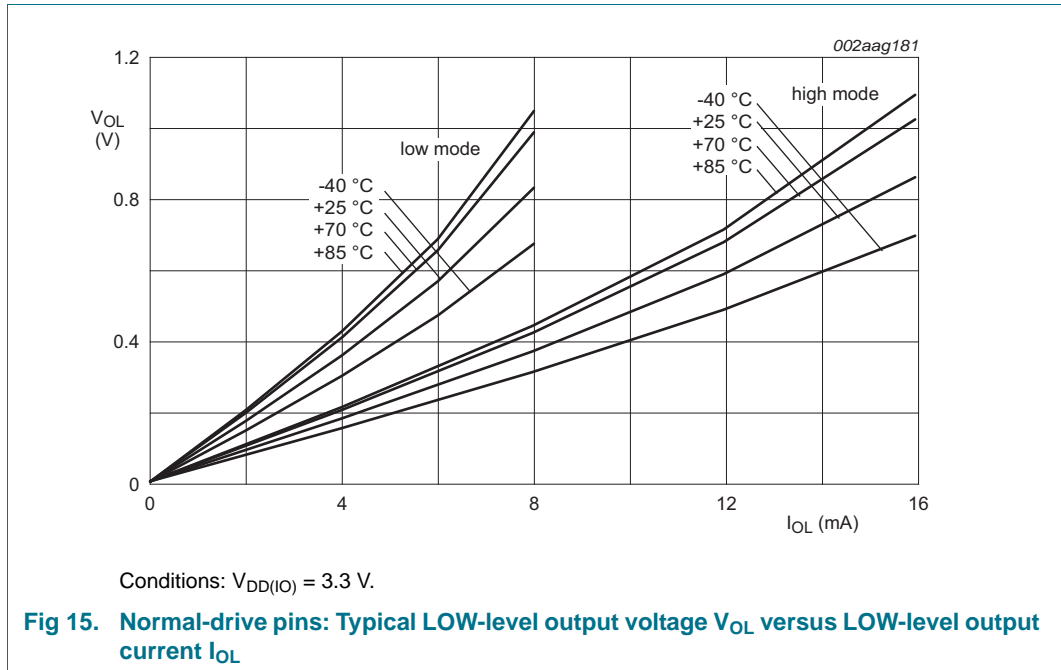

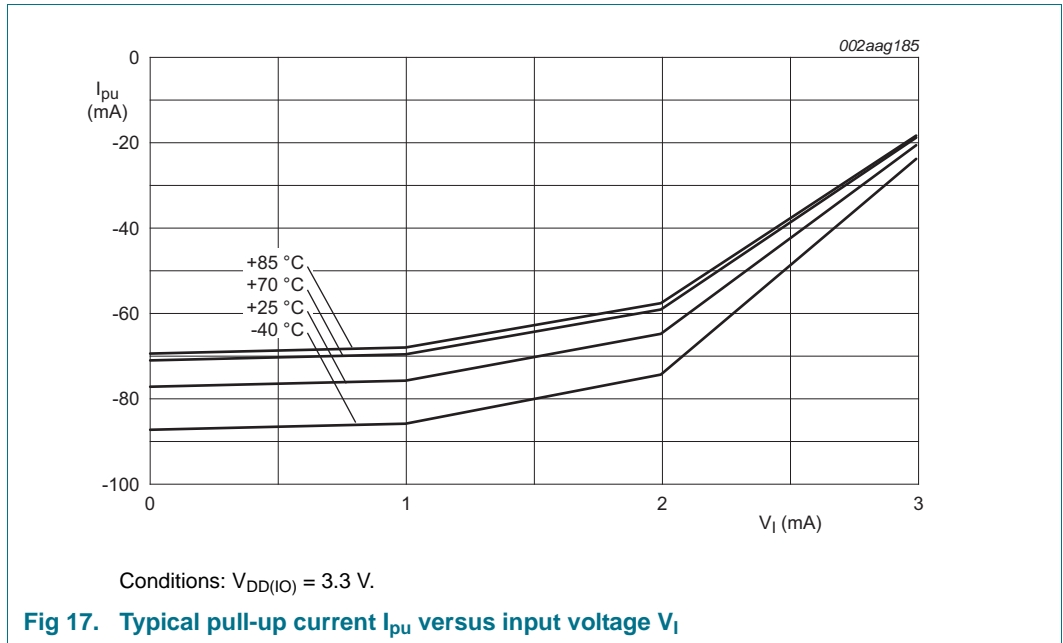

## 10.4 ADC characteristics

**Table 9. ADC static characteristics**

$T_{amb} = -40\text{ }^{\circ}\text{C}$  to  $+85\text{ }^{\circ}\text{C}$  unless otherwise specified; ADC frequency 9 MHz,  $V_{DD(3V3)} = 3.0\text{ V}$  to  $3.6\text{ V}$ .

Symbol	Parameter	Conditions	Min	Typ <sup>[1]</sup>	Max	Unit
$V_{IA}$	analog input voltage		0	-	$V_{DD(3V3)}$	V
$C_{ia}$	analog input capacitance		-	-	1	pF
$E_D$	differential linearity error	<a href="#">[2]</a> <a href="#">[3]</a> <a href="#">[4]</a>	-	-	$\pm 1$	LSB
$E_{L(adj)}$	integral non-linearity	<a href="#">[2]</a> <a href="#">[5]</a>	-	-	$\pm 2.5$	LSB
$E_O$	offset error	<a href="#">[2]</a> <a href="#">[6]</a>	-	-	$\pm 1$	LSB
$E_G$	gain error	<a href="#">[2]</a> <a href="#">[7]</a>	-	-	$\pm 3$	LSB
$E_T$	absolute error	<a href="#">[2]</a> <a href="#">[8]</a>	-	-	$\pm 3$	LSB
$f_{c(ADC)}$	ADC conversion frequency		-	-	257	kHz
$R_i$	input resistance	<a href="#">[9]</a> <a href="#">[10]</a>	-	-	3.9	$M\Omega$

[1] Typical ratings are not guaranteed. The values listed are at room temperature (25 °C), nominal supply voltages.

[2] Conditions:  $V_{SS} = 0\text{ V}$ ,  $V_{DD(3V3)} = 3.3\text{ V}$ .

[3] The ADC is monotonic, there are no missing codes.

[4] The differential linearity error ( $E_D$ ) is the difference between the actual step width and the ideal step width. See [Figure 18](#).

[5] The integral non-linearity ( $E_{L(adj)}$ ) is the peak difference between the center of the steps of the actual and the ideal transfer curve after appropriate adjustment of gain and offset errors. See [Figure 18](#).

[6] The offset error ( $E_O$ ) is the absolute difference between the straight line which fits the actual curve and the straight line which fits the ideal curve. See [Figure 18](#).

[7] The gain error ( $E_G$ ) is the relative difference in percent between the straight line fitting the actual transfer curve after removing offset error, and the straight line which fits the ideal transfer curve. See [Figure 18](#).

[8] The absolute error ( $E_T$ ) is the maximum difference between the center of the steps of the actual transfer curve of the non-calibrated ADC and the ideal transfer curve. See [Figure 18](#).

[9]  $T_{amb} = 25\text{ }^{\circ}\text{C}$ ; maximum sampling frequency  $f_s = 257\text{ kHz}$  and analog input capacitance  $C_{ia} = 1\text{ pF}$ .

[10] Input resistance  $R_i$  depends on the sampling frequency  $f_s$ :  $R_i = 1 / (f_s \times C_{ia})$ .

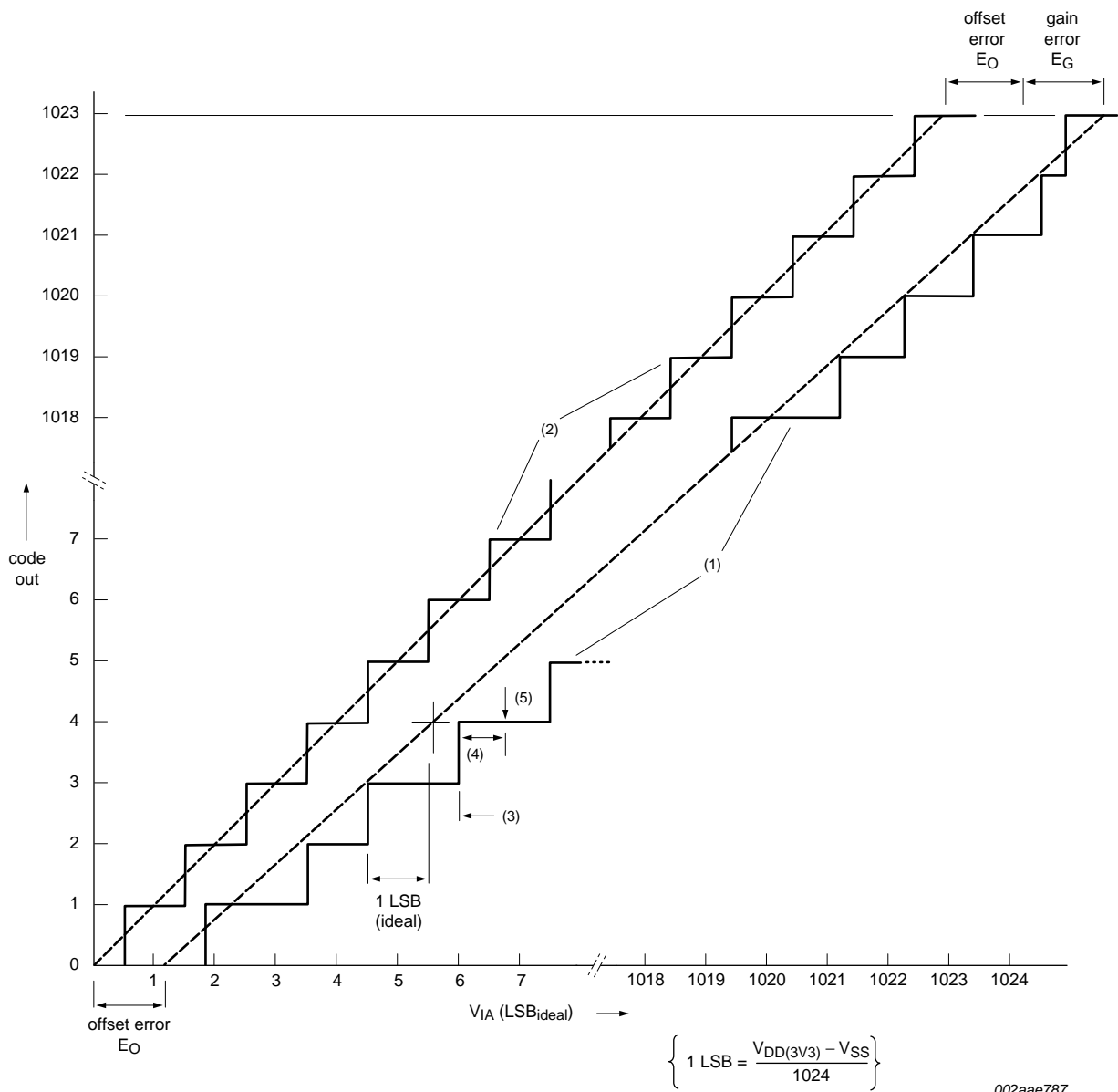

002aae787

- (1) Example of an actual transfer curve.
- (2) The ideal transfer curve.
- (3) Differential linearity error ( $E_D$ ).
- (4) Integral non-linearity ( $E_{L(adj)}$ ).
- (5) Center of a step of the actual transfer curve.

Fig 18. ADC characteristics

## 10.5 BOD static characteristics

**Table 10. BOD static characteristics<sup>[1]</sup>**

$T_{amb} = 25\text{ }^{\circ}\text{C}$ .

Symbol	Parameter	Conditions	Min	Typ	Max	Unit
$V_{th}$	threshold voltage	interrupt level 1				
		assertion	-	2.25	-	V
		de-assertion	-	2.39	-	V
		interrupt level 2				
		assertion	-	2.54	-	V
		de-assertion	-	2.67	-	V
		interrupt level 3				
		assertion	-	2.83	-	V
		de-assertion	-	2.93	-	V
		reset level 1				
		assertion	-	2.04	-	V
		de-assertion	-	2.18	-	V
		reset level 2				
		assertion	-	2.34	-	V
		de-assertion	-	2.47	-	V
		reset level 3				
		assertion	-	2.62	-	V
		de-assertion	-	2.76	-	V

[1] Interrupt levels are selected by writing the level value to the BOD control register BODCTRL, see *LPC122x user manual*.



## 11. Dynamic characteristics

### 11.1 Power-up ramp conditions

**Table 11. Power-up characteristics**

$T_{amb} = -40\text{ }^{\circ}\text{C}$  to  $+85\text{ }^{\circ}\text{C}$ .

Symbol	Parameter	Conditions	Min	Typ	Max	Unit
$t_r$	rise time	at $t = t_1$ : $0 < V_1 \leq 400\text{ mV}$	[1] 0	-	500	ms
$t_{wait}$	wait time		[1][2] 12	-	-	$\mu\text{s}$
$V_1$	input voltage	at $t = t_1$ on pin $V_{DD}$	0	-	400	mV

[1] See [Figure 19](#).

[2] The wait time specifies the time the power supply must be at levels below 400 mV before ramping up.

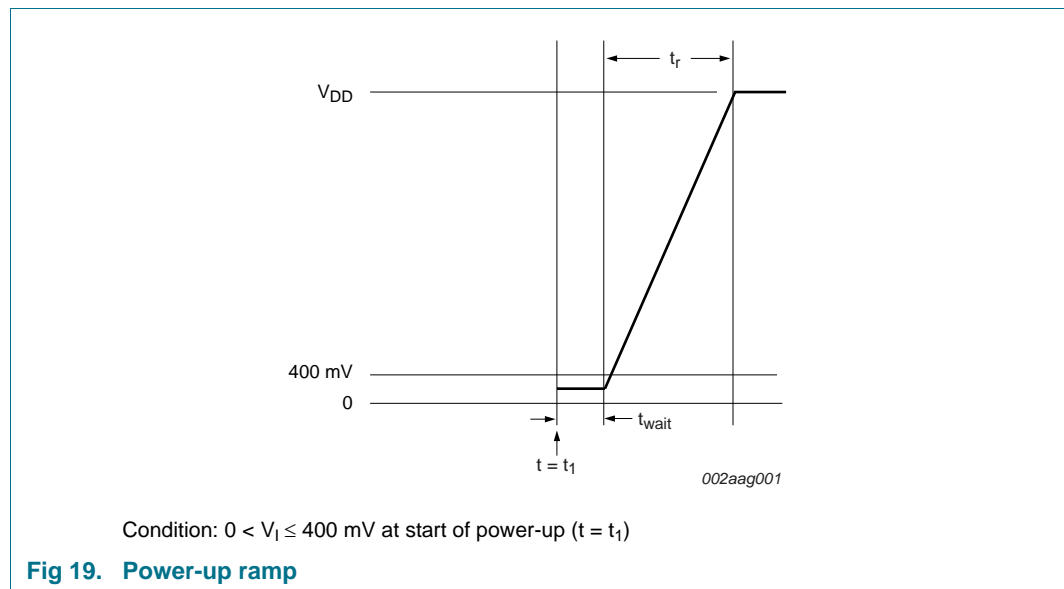

### 11.2 Flash memory

**Table 12. Dynamic characteristics: flash memory**

$T_{amb} = -40\text{ }^{\circ}\text{C}$  to  $+85\text{ }^{\circ}\text{C}$ ;  $V_{DD(3V3)}$  over specified ranges.

Symbol	Parameter	Conditions	Min	Max	Unit
$t_{er}$	erase time	for one page (512 byte)	[1] -	20	ms
		for one sector (4 kB)	[1]	162	ms
		for all sectors; mass erase	[1] -	20	ms
$t_{prog}$	programming time	one word (4 bytes)	[1] -	49	$\mu\text{s}$
		four sequential words	[1] -	194	$\mu\text{s}$
		128 bytes (one row of 32 words)	[1] -	765	$\mu\text{s}$
$N_{endu}$	endurance		[2] 20000	-	cycles
$t_{ret}$	retention time		10	-	years

[1] Erase and programming times are valid over the lifetime of the device (minimum 20000 cycles).

[2] Number of program/erase cycles.

### 11.3 External clock

**Table 13. Dynamic characteristics: external clock**

$T_{amb} = -40\text{ }^{\circ}\text{C}$  to  $+85\text{ }^{\circ}\text{C}$ ;  $V_{DD(3V3)}$  over specified ranges.[1]

Symbol	Parameter	Conditions	Min	Typ[2]	Max	Unit
$f_{osc}$	oscillator frequency		1	-	25	MHz
$T_{cy(clk)}$	clock cycle time		40	-	1000	ns
$t_{CHCX}$	clock HIGH time		$T_{cy(clk)} \times 0.4$	-	-	ns
$t_{CLCX}$	clock LOW time		$T_{cy(clk)} \times 0.4$	-	-	ns
$t_{CLCH}$	clock rise time		-	-	5	ns
$t_{CHCL}$	clock fall time		-	-	5	ns

[1] Parameters are valid over operating temperature range unless otherwise specified.

[2] Typical ratings are not guaranteed. The values listed are at room temperature (25 °C), nominal supply voltages.

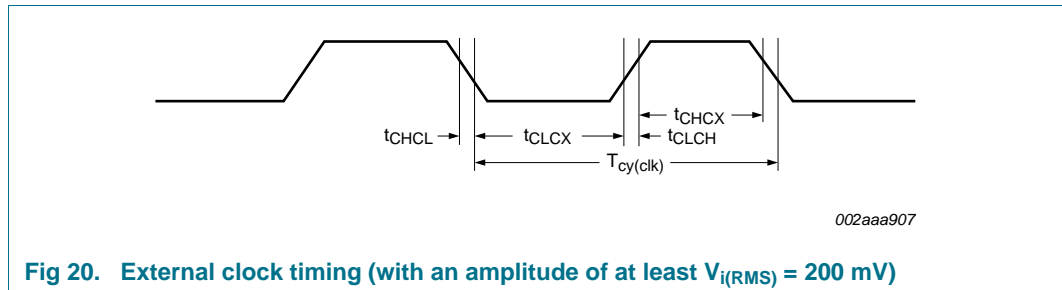

**Fig 20. External clock timing (with an amplitude of at least  $V_{i(RMS)} = 200\text{ mV}$ )**

11.4 Internal oscillators

**Table 14. Dynamic characteristics: internal oscillators**

$T_{amb} = -40\text{ }^{\circ}\text{C}$  to  $+85\text{ }^{\circ}\text{C}$ ;  $V_{DD(3V3)}$  over specified ranges.<sup>[1]</sup>

Symbol	Parameter	Conditions	Min	Typ <sup>[2]</sup>	Max	Unit
$f_{osc(RC)}$	internal RC oscillator frequency	-	11.88	12	12.12	MHz

[1] Parameters are valid over operating temperature range unless otherwise specified.

[2] Typical ratings are not guaranteed. The values listed are at nominal supply voltages.

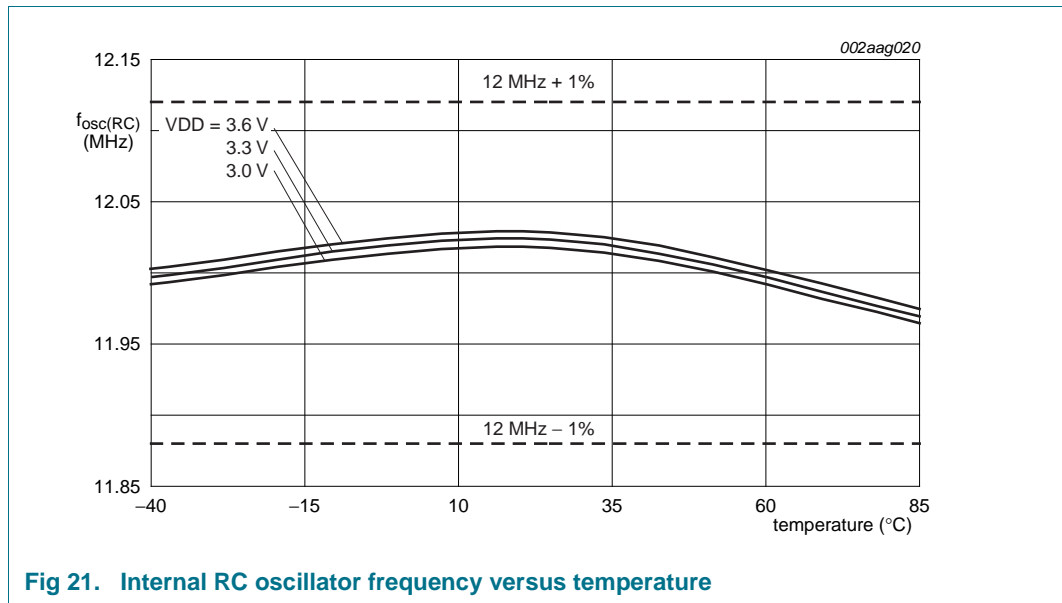

**Fig 21. Internal RC oscillator frequency versus temperature**

**Table 15. Dynamic characteristics: Watchdog oscillator**

Symbol	Parameter	Conditions	Min	Typ <sup>[1]</sup>	Max	Unit	
$f_{osc(int)}$	internal oscillator frequency	DIVSEL = 0x1F, FREQSEL = 0x1 in the WDTOSCCTRL register;	[2][3]	-	7.8	-	kHz
		DIVSEL = 0x00, FREQSEL = 0xF in the WDTOSCCTRL register	[2][3]	-	1700	-	kHz

[1] Typical ratings are not guaranteed. The values listed are at room temperature (25 °C), nominal supply voltages.

[2] The typical frequency spread over processing and temperature ( $T_{amb} = -40\text{ }^{\circ}\text{C}$  to  $+85\text{ }^{\circ}\text{C}$ ) is  $\pm 40\%$ .

[3] See the *LPC122x user manual*.

11.5 I<sup>2</sup>C-busTable 16. Dynamic characteristics: I<sup>2</sup>C-bus pins $T_{amb} = -40\text{ }^{\circ}\text{C}$  to  $+85\text{ }^{\circ}\text{C}$ . [1]

Symbol	Parameter	Conditions	Min	Max	Unit
$f_{SCL}$	SCL clock frequency	Standard-mode	0	100	kHz
		Fast-mode	0	400	kHz
		Fast-mode Plus	0	1	MHz
$t_f$	fall time <a href="#">[2][3][4][5]</a>	of both SDA and SCL signals	-	300	ns
		Standard-mode			
		Fast-mode	$20 + 0.1 \times C_b$	300	ns
$t_{HD;DAT}$	data hold time <a href="#">[6][2][7]</a>	Fast-mode Plus	-	120	ns
		Standard-mode	4.7	-	$\mu\text{s}$
		Fast-mode	1.3	-	$\mu\text{s}$
$t_{HIGH}$	HIGH period of the SCL clock	Fast-mode Plus	0.5	-	$\mu\text{s}$
		Standard-mode	4.0	-	$\mu\text{s}$
		Fast-mode	0.6	-	$\mu\text{s}$
$t_{SU;DAT}$	data set-up time <a href="#">[8][9]</a>	Fast-mode Plus	0.26	-	$\mu\text{s}$
		Standard-mode	0	-	$\mu\text{s}$
		Fast-mode	0	-	$\mu\text{s}$
$t_{SU;DAT}$	data set-up time <a href="#">[8][9]</a>	Standard-mode	250	-	ns
		Fast-mode	100	-	ns
		Fast-mode Plus	50	-	ns

- [1] Parameters are valid over operating temperature range unless otherwise specified.
- [2] A device must internally provide a hold time of at least 300 ns for the SDA signal (with respect to the  $V_{IH}(\text{min})$  of the SCL signal) to bridge the undefined region of the falling edge of SCL.
- [3]  $C_b$  = total capacitance of one bus line in pF. If mixed with Hs-mode devices, faster fall times are allowed.
- [4] The maximum  $t_f$  for the SDA and SCL bus lines is specified at 300 ns. The maximum fall time for the SDA output stage  $t_f$  is specified at 250 ns. This allows series protection resistors to be connected in between the SDA and the SCL pins and the SDA/SCL bus lines without exceeding the maximum specified  $t_f$ .
- [5] In Fast-mode Plus, fall time is specified the same for both output stage and bus timing. If series resistors are used, designers should allow for this when considering bus timing.
- [6]  $t_{HD;DAT}$  is the data hold time that is measured from the falling edge of SCL; applies to data in transmission and the acknowledge.
- [7] The maximum  $t_{HD;DAT}$  could be 3.45  $\mu\text{s}$  and 0.9  $\mu\text{s}$  for Standard-mode and Fast-mode but must be less than the maximum of  $t_{VD;DAT}$  or  $t_{VD;ACK}$  by a transition time. This maximum must only be met if the device does not stretch the LOW period ( $t_{LOW}$ ) of the SCL signal. If the clock stretches the SCL, the data must be valid by the set-up time before it releases the clock.
- [8]  $t_{SU;DAT}$  is the data set-up time that is measured with respect to the rising edge of SCL; applies to data in transmission and the acknowledge.
- [9] A Fast-mode I<sup>2</sup>C-bus device can be used in a Standard-mode I<sup>2</sup>C-bus system but the requirement  $t_{SU;DAT} = 250\text{ ns}$  must then be met. This will automatically be the case if the device does not stretch the LOW period of the SCL signal. If such a device does stretch the LOW period of the SCL signal, it must output the next data bit to the SDA line  $t_{r(\text{max})} + t_{SU;DAT} = 1000 + 250 = 1250\text{ ns}$  (according to the Standard-mode I<sup>2</sup>C-bus specification) before the SCL line is released. Also the acknowledge timing must meet this set-up time.



## 12. Application information

### 12.1 XTAL input

The input voltage to the on-chip oscillators is limited to 1.8 V. If the oscillator is driven by a clock in slave mode, it is recommended that the input be coupled through a capacitor with  $C_i = 100$  pF. To limit the input voltage to the specified range, choose an additional capacitor to ground  $C_g$  which attenuates the input voltage by a factor  $C_i/(C_i + C_g)$ . In slave mode, a minimum of 200 mV(RMS) is needed.

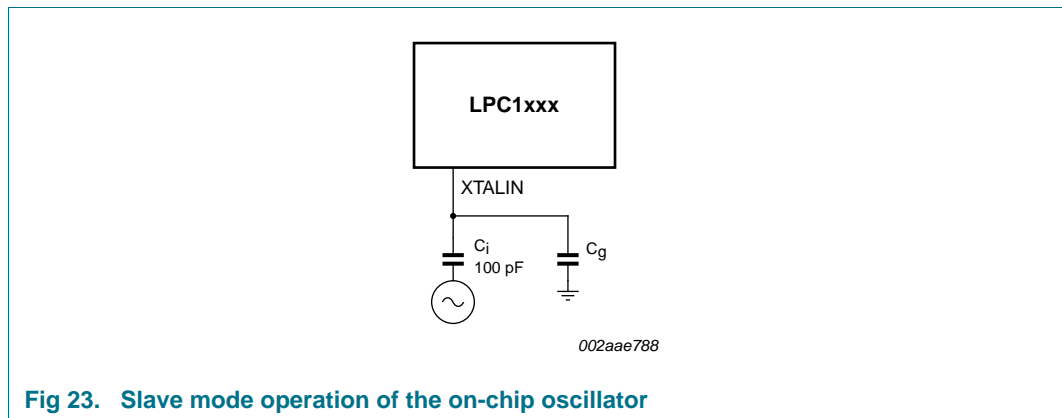

Fig 23. Slave mode operation of the on-chip oscillator

### 12.2 XTAL Printed Circuit Board (PCB) layout guidelines

The crystal should be connected on the PCB as close as possible to the oscillator input and output pins of the chip. Take care that the load capacitors  $C_{x1}$ ,  $C_{x2}$ , and  $C_{x3}$  in case of third overtone crystal usage have a common ground plane. The external components must also be connected to the ground plain. Loops must be made as small as possible in order to keep the noise coupled in via the PCB as small as possible. Also parasitics should stay as small as possible. Values of  $C_{x1}$  and  $C_{x2}$  should be chosen smaller accordingly to the increase in parasitics of the PCB layout.

### 12.3 ElectroMagnetic Compatibility (EMC)

Radiated emission measurements according to the IEC61967-2 standard using the TEM-cell method are shown for the LPC1227FBD64/301 in [Table 17](#).

**Table 17. ElectroMagnetic Compatibility (EMC) for part LPC1227FBD64/301 (TEM-cell method)**

$V_{DD} = 3.3\text{ V}$ ;  $T_{amb} = 25\text{ °C}$ .

Parameter	Frequency band	System clock =			Unit
		12 MHz	24 MHz	33 MHz	
<b>Input clock: IRC (12 MHz)</b>					
maximum peak level	150 kHz - 30 MHz	-4.2	-3.8	-6.4	dB $\mu$ V
	30 MHz - 150 MHz	7.3	5.4	9	dB $\mu$ V
	150 MHz - 1 GHz	16.4	20.1	23.4	dB $\mu$ V
IEC level <sup>[1]</sup>	-	M	L	L	-
<b>Input clock: crystal oscillator (12 MHz)</b>					
maximum peak level	150 kHz - 30 MHz	-4.8	-4	-6.6	dB $\mu$ V
	30 MHz - 150 MHz	6.9	5.6	10	dB $\mu$ V
	150 MHz - 1 GHz	16.3	20.3	22.3	dB $\mu$ V
IEC level <sup>[1]</sup>	-	M	L	L	-

[1] IEC levels refer to *Appendix D in the IEC61967-2 Specification*.

13. Package outline

LQFP100: plastic low profile quad flat package; 100 leads; body 14 x 14 x 1.4 mm

SOT407-1

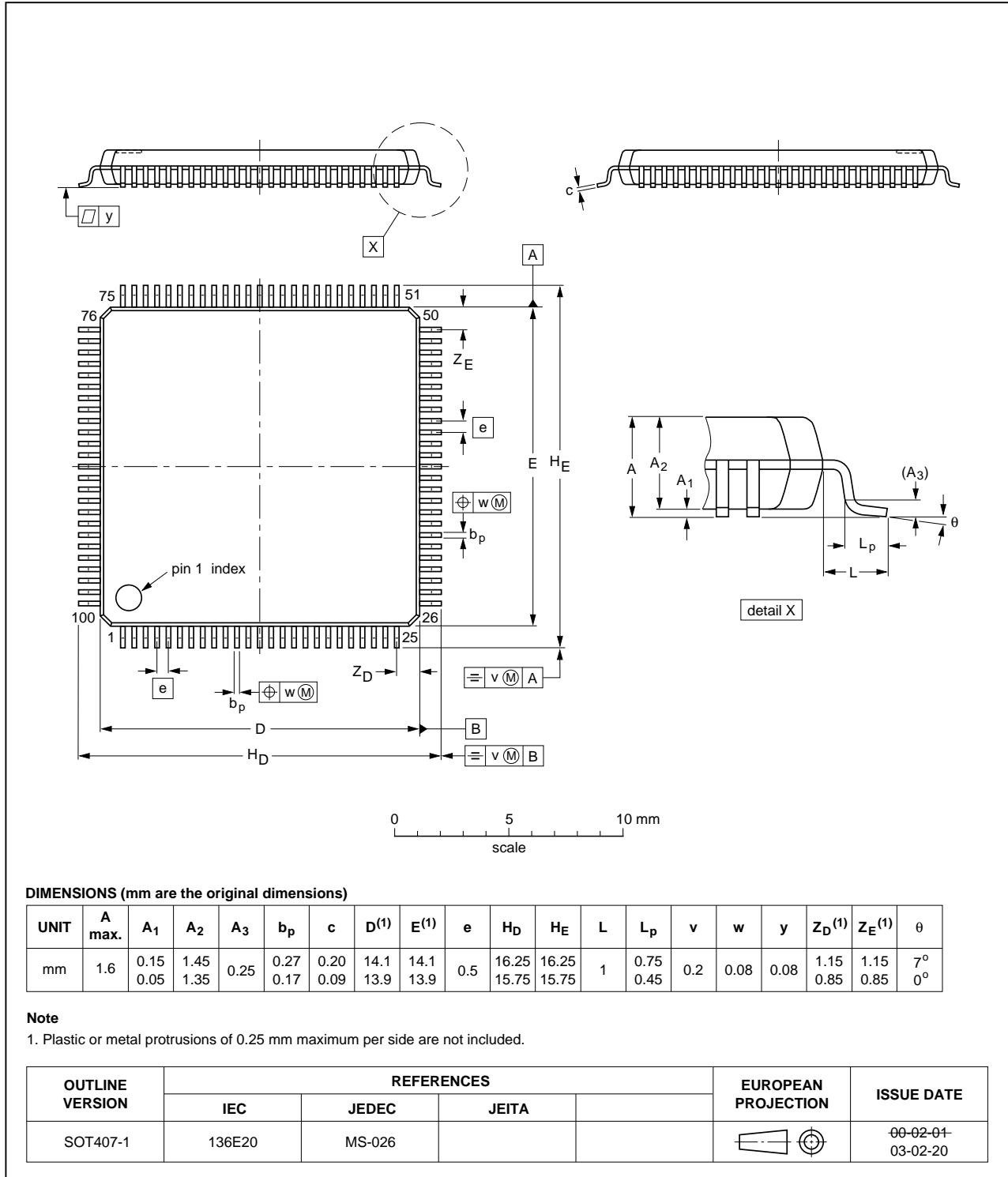

Fig 24. Package outline LQFP100



14. Soldering

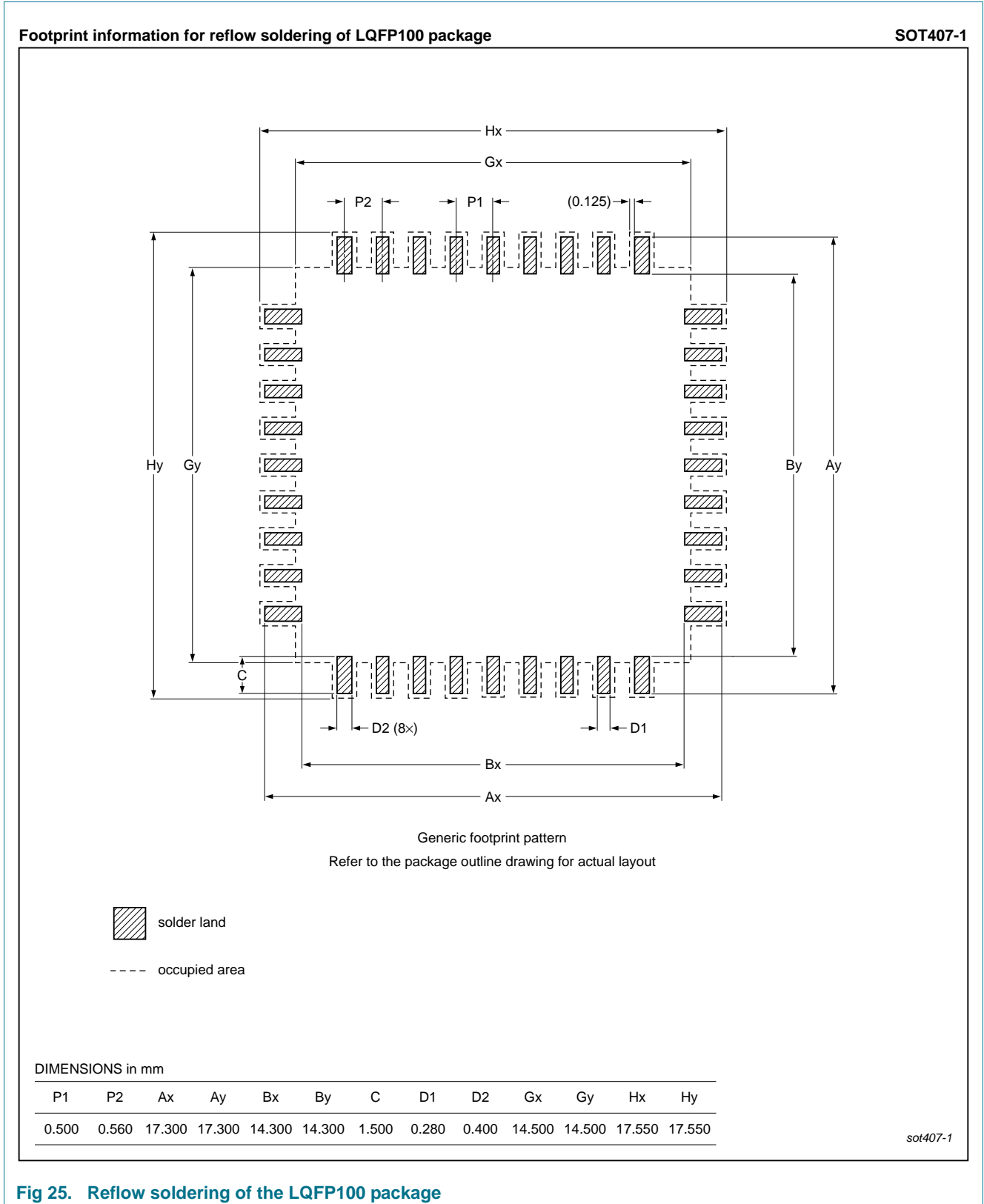

Fig 25. Reflow soldering of the LQFP100 package

## 15. References

---

- [1] *LPC122x data sheet*, <http://www.nxp.com/microcontrollers>
- [2] *PCF8576D data sheet*, <http://www.nxp.com/microcontrollers>

## 16. Revision history

Table 18. Revision history

Document ID	Release date	Data sheet status	Change notice	Supersedes
LPC12D27 v.1	20110920	Product data sheet	-	-

## 17. Legal information

### 17.1 Data sheet status

Document status <sup>[1][2]</sup>	Product status <sup>[3]</sup>	Definition
Objective [short] data sheet	Development	This document contains data from the objective specification for product development.
Preliminary [short] data sheet	Qualification	This document contains data from the preliminary specification.
Product [short] data sheet	Production	This document contains the product specification.

[1] Please consult the most recently issued document before initiating or completing a design.

[2] The term 'short data sheet' is explained in section "Definitions".

[3] The product status of device(s) described in this document may have changed since this document was published and may differ in case of multiple devices. The latest product status information is available on the Internet at URL <http://www.nxp.com>.

### 17.2 Definitions

**Draft** — The document is a draft version only. The content is still under internal review and subject to formal approval, which may result in modifications or additions. NXP Semiconductors does not give any representations or warranties as to the accuracy or completeness of information included herein and shall have no liability for the consequences of use of such information.

**Short data sheet** — A short data sheet is an extract from a full data sheet with the same product type number(s) and title. A short data sheet is intended for quick reference only and should not be relied upon to contain detailed and full information. For detailed and full information see the relevant full data sheet, which is available on request via the local NXP Semiconductors sales office. In case of any inconsistency or conflict with the short data sheet, the full data sheet shall prevail.

**Product specification** — The information and data provided in a Product data sheet shall define the specification of the product as agreed between NXP Semiconductors and its customer, unless NXP Semiconductors and customer have explicitly agreed otherwise in writing. In no event however, shall an agreement be valid in which the NXP Semiconductors product is deemed to offer functions and qualities beyond those described in the Product data sheet.

### 17.3 Disclaimers

**Limited warranty and liability** — Information in this document is believed to be accurate and reliable. However, NXP Semiconductors does not give any representations or warranties, expressed or implied, as to the accuracy or completeness of such information and shall have no liability for the consequences of use of such information.

In no event shall NXP Semiconductors be liable for any indirect, incidental, punitive, special or consequential damages (including - without limitation - lost profits, lost savings, business interruption, costs related to the removal or replacement of any products or rework charges) whether or not such damages are based on tort (including negligence), warranty, breach of contract or any other legal theory.

Notwithstanding any damages that customer might incur for any reason whatsoever, NXP Semiconductors' aggregate and cumulative liability towards customer for the products described herein shall be limited in accordance with the *Terms and conditions of commercial sale* of NXP Semiconductors.

**Right to make changes** — NXP Semiconductors reserves the right to make changes to information published in this document, including without limitation specifications and product descriptions, at any time and without notice. This document supersedes and replaces all information supplied prior to the publication hereof.

**Suitability for use** — NXP Semiconductors products are not designed, authorized or warranted to be suitable for use in life support, life-critical or safety-critical systems or equipment, nor in applications where failure or

malfunction of an NXP Semiconductors product can reasonably be expected to result in personal injury, death or severe property or environmental damage. NXP Semiconductors accepts no liability for inclusion and/or use of NXP Semiconductors products in such equipment or applications and therefore such inclusion and/or use is at the customer's own risk.

**Applications** — Applications that are described herein for any of these products are for illustrative purposes only. NXP Semiconductors makes no representation or warranty that such applications will be suitable for the specified use without further testing or modification.

Customers are responsible for the design and operation of their applications and products using NXP Semiconductors products, and NXP Semiconductors accepts no liability for any assistance with applications or customer product design. It is customer's sole responsibility to determine whether the NXP Semiconductors product is suitable and fit for the customer's applications and products planned, as well as for the planned application and use of customer's third party customer(s). Customers should provide appropriate design and operating safeguards to minimize the risks associated with their applications and products.

NXP Semiconductors does not accept any liability related to any default, damage, costs or problem which is based on any weakness or default in the customer's applications or products, or the application or use by customer's third party customer(s). Customer is responsible for doing all necessary testing for the customer's applications and products using NXP Semiconductors products in order to avoid a default of the applications and the products or of the application or use by customer's third party customer(s). NXP does not accept any liability in this respect.

**Limiting values** — Stress above one or more limiting values (as defined in the Absolute Maximum Ratings System of IEC 60134) will cause permanent damage to the device. Limiting values are stress ratings only and (proper) operation of the device at these or any other conditions above those given in the Recommended operating conditions section (if present) or the Characteristics sections of this document is not warranted. Constant or repeated exposure to limiting values will permanently and irreversibly affect the quality and reliability of the device.

**Terms and conditions of commercial sale** — NXP Semiconductors products are sold subject to the general terms and conditions of commercial sale, as published at <http://www.nxp.com/profile/terms>, unless otherwise agreed in a valid written individual agreement. In case an individual agreement is concluded only the terms and conditions of the respective agreement shall apply. NXP Semiconductors hereby expressly objects to applying the customer's general terms and conditions with regard to the purchase of NXP Semiconductors products by customer.

**No offer to sell or license** — Nothing in this document may be interpreted or construed as an offer to sell products that is open for acceptance or the grant, conveyance or implication of any license under any copyrights, patents or other industrial or intellectual property rights.

**Export control** — This document as well as the item(s) described herein may be subject to export control regulations. Export might require a prior authorization from national authorities.

**Non-automotive qualified products** — Unless this data sheet expressly states that this specific NXP Semiconductors product is automotive qualified, the product is not suitable for automotive use. It is neither qualified nor tested in accordance with automotive testing or application requirements. NXP Semiconductors accepts no liability for inclusion and/or use of non-automotive qualified products in automotive equipment or applications.

In the event that customer uses the product for design-in and use in automotive applications to automotive specifications and standards, customer (a) shall use the product without NXP Semiconductors' warranty of the product for such automotive applications, use and specifications, and (b) whenever customer uses the product for automotive applications beyond NXP Semiconductors' specifications such use shall be solely at customer's

own risk, and (c) customer fully indemnifies NXP Semiconductors for any liability, damages or failed product claims resulting from customer design and use of the product for automotive applications beyond NXP Semiconductors' standard warranty and NXP Semiconductors' product specifications.

## 17.4 Trademarks

Notice: All referenced brands, product names, service names and trademarks are the property of their respective owners.

**I<sup>2</sup>C-bus** — logo is a trademark of NXP B.V.

## 18. Contact information

For more information, please visit: <http://www.nxp.com>

For sales office addresses, please send an email to: [salesaddresses@nxp.com](mailto:salesaddresses@nxp.com)

## 19. Contents

<b>1</b>	<b>General description</b> . . . . .	<b>1</b>	<b>15</b>	<b>References</b> . . . . .	<b>42</b>
<b>2</b>	<b>Features and benefits</b> . . . . .	<b>1</b>	<b>16</b>	<b>Revision history</b> . . . . .	<b>43</b>
<b>3</b>	<b>Applications</b> . . . . .	<b>3</b>	<b>17</b>	<b>Legal information</b> . . . . .	<b>44</b>
<b>4</b>	<b>Ordering information</b> . . . . .	<b>3</b>	<b>17.1</b>	Data sheet status . . . . .	<b>44</b>
4.1	Ordering options . . . . .	3	<b>17.2</b>	Definitions . . . . .	44
<b>5</b>	<b>Block diagram</b> . . . . .	<b>4</b>	<b>17.3</b>	Disclaimers . . . . .	44
<b>6</b>	<b>Pinning information</b> . . . . .	<b>7</b>	<b>17.4</b>	Trademarks . . . . .	45
6.1	Pinning . . . . .	7	<b>18</b>	<b>Contact information</b> . . . . .	<b>45</b>
6.2	Pin description . . . . .	8	<b>19</b>	<b>Contents</b> . . . . .	<b>46</b>
<b>7</b>	<b>Functional description</b> . . . . .	<b>14</b>			
7.1	LPC1227 microcontroller . . . . .	14			
7.2	LCD driver . . . . .	14			
7.2.1	General description . . . . .	14			
7.2.2	Functional description . . . . .	15			
7.2.3	Reset state of the LCD controller and pins . . . . .	15			
7.2.4	LCD bias generator . . . . .	15			
7.2.5	Oscillator . . . . .	15			
7.2.5.1	Internal clock . . . . .	15			
7.2.6	Timing . . . . .	16			
7.2.7	Display register . . . . .	16			
7.2.8	Segment outputs . . . . .	16			
7.2.9	Backplane outputs . . . . .	16			
7.2.10	Display RAM . . . . .	16			
<b>8</b>	<b>Limiting values</b> . . . . .	<b>17</b>			
<b>9</b>	<b>Thermal characteristics</b> . . . . .	<b>18</b>			
9.1	Thermal characteristics . . . . .	18			
<b>10</b>	<b>Static characteristics</b> . . . . .	<b>19</b>			
10.1	Peripheral power consumption . . . . .	22			
10.2	Power consumption . . . . .	22			
10.3	Electrical pin characteristics . . . . .	26			
10.4	ADC characteristics . . . . .	30			
10.5	BOD static characteristics . . . . .	32			
<b>11</b>	<b>Dynamic characteristics</b> . . . . .	<b>33</b>			
11.1	Power-up ramp conditions . . . . .	33			
11.2	Flash memory . . . . .	34			
11.3	External clock . . . . .	34			
11.4	Internal oscillators . . . . .	35			
11.5	I <sup>2</sup> C-bus . . . . .	36			
<b>12</b>	<b>Application information</b> . . . . .	<b>38</b>			
12.1	XTAL input . . . . .	38			
12.2	XTAL Printed Circuit Board (PCB) layout guidelines . . . . .	38			
12.3	ElectroMagnetic Compatibility (EMC) . . . . .	39			
<b>13</b>	<b>Package outline</b> . . . . .	<b>40</b>			
<b>14</b>	<b>Soldering</b> . . . . .	<b>41</b>			

Please be aware that important notices concerning this document and the product(s) described herein, have been included in section 'Legal information'.

© NXP B.V. 2011.

All rights reserved.

For more information, please visit: <http://www.nxp.com>

For sales office addresses, please send an email to: [salesaddresses@nxp.com](mailto:salesaddresses@nxp.com)

Date of release: 20 September 2011

Document identifier: LPC12D27