

PREPARED BY: DATE	SHARP	SPEC No. LCY-06037B
<i>N. Maunishi Oct. 17, 2006</i>		FILE No.
APPROVED BY: DATE		ISSUE: Oct. 17, 2006
<i>T. Samoto Oct. 17, 2006</i>		PAGE : 26pages
MOBILE LIQUID CRYSTAL DISPLAY GROUP I SHARP CORPORATION SPECIFICATION		

DEVICE SPECIFICATION FOR
TFT - LCD module
 MODEL No. LQ065T9DZ03

CUSTOMER'S APPROVAL

DATE _____

BY _____

PRESENTED

BY *H. Yakushigawa*
 H.YAKUSHIGAWA
 DEPARTMENT GENERAL MANAGER
 ENGINEERING DAPARTMENT II
 MOBILE LCD DESIGN CENTER
 MOBILE LIQUID CRYSTAL DISPLAY GROUP I
 SHARP CORPORATION

RECORDS OF REVISION

MODEL No : LQ065T9DZ03

SPEC No.	Date	NO.	PAGE	SUMMARY	NOTE
LCY-05055	Sep.16. 2005	-	-	-	1 st Issue
LCY-06037	Sep.19. 2006		13/18	Table 9-1 - Contrast ratio (Perpendicular) added Typ. at 25 , -25 , 0 , 60 - Uniformity of luminance Added. 【Note 9-11】 Added. - Flicker rate Added. 【Note 9-12】 Added. - Gamma tolerance added	2 nd Issue
			14	Iso-contrast diagram and gamma value (Addition)	
			22	Table 15-1 Heat shock test added.	
			23	Fig.1 Outline dimensions (Modification)	
			25	Fig. 3 The Construction Form Added.	
LCY-06037B	Oct.17. 2006	B	14	Gamma curve & gamma ratio revised.	3 rd Issue
			15	Table 9-2 Luminance ratio (Reference data) added	

NOTICE

This publication is the proprietary of SHARP and is copyrighted, with all rights reserved. Under the copyright laws, no part of this publication may be reproduced or transmitted in any form or by any means, electronic or mechanical for any purpose, in whole or in part, without the express written permission of SHARP. Express written permission is also required before any use of this publication may be made by a third party.

The application circuit examples in this publication are provided to explain the representative applications of SHARP's devices and are not intended to guarantee any circuit design or permit any industrial property right or other rights to be executed. SHARP takes no responsibility for any problems related to any industrial property right or a third party resulting from the use of SHARP's devices, except for those resulting directly from device manufacturing processes.

In the absence of confirmation by device specification sheets, SHARP takes no responsibility for any defects that occur in equipment using any of SHARP's devices, shown in catalogs, data books, etc. Contact SHARP in order to obtain the latest device specification sheets before using any SHARP's device.

SHARP reserves the right to make changes in the specifications, characteristics, data, materials, structures and other contents described herein at any time without notice in order to improve design or reliability. Contact SHARP in order to obtain the latest specification sheets before using any SHARP's device. Manufacturing locations are also subject to change without notice.

Observe the following points when using any device in this publication. SHARP takes no responsibility for damage caused by improper use of the devices.

The devices in this publication are designed for use in general electronic equipment designs, such as:

- Car Navigation system
- Automotive auxiliary information display
- Automotive audio visual equipment

The appropriate design measures should be taken to ensure reliability and safety when SHARP's devices are used for equipment such as:

- Transportation control and safety equipment (i.e., aircraft, trains, automobiles, etc.)
- Traffic signals
- Gas leakage sensor breakers
- Alarm equipment
- Various safety devices etc.

SHARP's devices shall not be used for equipment that requires extremely high level of reliability, such as:

- Military and space applications
- Nuclear power control equipment
- Medical equipment for life support

Contact a SHARP representative, in advance, when intending to use SHARP's devices for any "specific" applications other than those recommended by SHARP.

Contact and consult with a SHARP representative if there are any questions about the contents of this publication.

(1) Application

This technical literature applies to color TFT-LCD module, LQ065T9DZ03.

(2) Summary and Features

This module is a color active matrix LCD module incorporating amorphous silicon TFT (Thin Film Transistor). It is practicable in both transmissive-type and reflection-type modes. It is composed of a color TFT-LCD panel, driver ICs, control/source-PWB, gate-PWB, frame, shielding front case, shielding back case and backlight unit. Graphics and texts can be displayed on a $400 \times 3(\text{RGB}) \times 240$ dots panel with 262,144 colors by supplying 18 bit data signals(6 bit/color).

It isn't composed DC/AC inverter .

Utilizes a panel with a 16:9 aspect ratio, which makes the module suitable for use in wide-screen systems.

The 6.5 screen produces a high resolution image that is composed of 96,000 pixels elements in a stripe arrangement.

Wide viewing field angle technology is employed.

By adopting an active matrix drive, a picture with high contrast is realized.

Reflection due to external light is minimized through the use of a low reflection, black matrix and an antiglare (AG) and antireflection(AR) plate.

AG and AR surface polarization plate is used.

An inverted video display in the vertical and horizontal directions is possible.

Having considered vehicle-based use, the module contains a self heating backlight system whose emission characteristics are improved in low temperature.

(3) Mechanical specifications

table 3-1

Parameter	Specifications	Units	Remarks
Display format	96,000	pixels	
	1,200(W) × 240(H)	dots	
Active area	143.4 (W) × 79.32 (H)	mm	
Screen size (Diagonal)	16.4[6.5 "]	cm	
Dot pitch	0.1195 (W) × 0.3305 (H)	mm	
Pixel configuration	R,G,B Stripe configuration		
Outline dimension	155 (W) × 89.2 (H) × 12.5 (D)	mm	【Note3-1】
Mass	205 (MAX)	g	

【Note 3-1】

Typical values are given. For detailed measurements and tolerances, please refer to Fig. 1.

(4)Input terminal

4-1)TFT-LCD panel driving part

Used connector:DF9MA-31P-1V(Gilding type: Hirose Electric Co.,Ltd)

Fit connctor:DF9 -31S-1V(Gilding type: Hirose Electric Co.,Ltd)

(:A,B or M type)

Table 4-1 CN1

Pin No.	Symbol	Description	Remarks
1	V G H	power supply	
2	V S H	power supply	
3	V S H	power supply	
4	E N A B	Signal to settle the horizontal display position	【Note4-2】
5	H V R	Selection for horizontal and vertical scanning direction	【Note4-3】
6	B 5	BLUE data signal(MSB)	
7	B 4	BLUE data signal	
8	B 3	BLUE data signal	
9	B 2	BLUE data signal	
1 0	B 1	BLUE data signal	
1 1	B 0	BLUE data signal(LSB)	
1 2	G N D	ground	
1 3	G 5	GREEN data signal(MSB)	
1 4	G 4	GREEN data signal	
1 5	G 3	GREEN data signal	
1 6	G 2	GREEN data signal	
1 7	G 1	GREEN data signal	
1 8	G 0	GREEN data signal(LSB)	
1 9	G N D	ground	
2 0	R 5	RED data signal(MSB)	
2 1	R 4	RED data signal	
2 2	R 3	RED data signal	
2 3	R 2	RED data signal	
2 4	R 1	RED data signal	
2 5	R 0	RED data signal(LSB)	
2 6	V G L	power supply	
2 7	V sync	Vertical synchronous signal	【Note4-1】
2 8	H sync	Horizontal synchronous signal	【Note4-1】
2 9	G N D	ground	
3 0	C K	Clock signal for sampling each data signal	
3 1	G N D	ground	

【Note 4-1】

Hsync	Positive
Vsync	Positive

【Note 4-2】

The horizontal display start timing is settled in accordance early for 4 pixels from a rising timing of ENAB signal. In case ENAB is fixed "Low",the horizontal start timing is determined as described in Fig7-1.

(Don't keep ENAB "High" during operation.(7-2).)

【Note 4-3】

HVR = "High": Regular video

HVR = "Low" : Horizontally and Vertically inverted video

4-2) Backlight fluorescent tube driving part

Used connector: BHR-02(8.0)VS-IN(Gilding type: JST Co.,Ltd)

Fit connector: SM02(8.0)B-BHS-1N(Gilding type: JST Co.,Ltd)

Table 4-2 terminal: CN2

No.	symbol	i / o	function	Color of FL cable
1	VL1	i	input terminal(Hi voltage side)	ORANGE
2	NC	-	non connection	
3	VL2	i	input terminal (Low voltage side)	BLACK

4-3) Backlight operating part

Table 4-3

terminal	No.	symbol	remarks
CN3	1	T H 1	Thermistor
	2	T H 2	Thermistor

【Note4-4】 Use for the detection of the lamp temperature.

Kind of thermistor : 203GT-1(Gilding type: Ishizuka Electric Co.,Ltd)

Zero load resistance value about 25 : 20k ±3%

(5) Absolute maximum ratings

Table 5-1

GND = 0 V

Parameter	Symbol	MIN	MAX	Unit	Note
Input voltage	V_I	-0.3	+3.6	V	【Note 5-1,7】
+5V power supply	V S H	0	+6.0	V	【Note 5-7】
+10V power supply High	V G H	0	+12	V	【Note 5-7】
- 10V power supply Low	V G L	0	- 12	V	【Note 5-7】
Storage temperature	T stg	-40	+95		【Note 5-2,3,6,8】
Operating temperature (panel surface)	T opr1	-40	+85		【Note 5-2,3,4,6,8,9】
Operating temperature (Ambient temperature)	T opr2	-40	+80		【Note 5-5,6,8,9】

【Note 5-1】 CK,R0 ~ R5,G0 ~ G5,B0 ~ B5,Hsync,Vsync,ENAB,HVR

【Note 5-2】 This rating applies to all parts of the module and should not be exceeded.

【Note 5-3】 Maximum wet-bulb temperature is less than 49 . Condensation of dew must be avoided as electrical current leaks will occur, causing a degradation of performance specifications.

【Note 5-4】 The operating temperature only guarantees operation of the circuit. For contrast, speed response, and other factors related to display quality, determine operating temperature using the formula $T_a = +25$

【Note 5-5】 If the environment temperature will be over +80°C, lamp current must be reduced in order to keep the agreed panel operating temperature of +85°C.

【Note 5-6】 Refer to Table 15-1

【Note 5-7】 $T_p = -40 \sim +95$

【Note 5-8】 85°C 240h; 95° 120h

【Note 5-9】 Operating temperature between -40° C to -31° C does not provide a correct image on the LCD, but no damage of the display function will occur
Reduced requirements for operating tests:"damp heat, cyclic" (GS95003-4 6.8) Polarizer degradation occurs in high temperature/
high humidity cycles so it is not used for judgement of the test:

"lifetime test" (GS95003-1) 1500h have been tested with a small degradation of polarizer

(6)Electrical characteristics
6-1)TFT-LCD panel driving section

Table 6-1

GND = 0 V , T_p= 30 ~ 85

Parameter		Symbol	MIN	TYP	MAX	Unit	Remarks
+5V	Supply voltage	VSH	+4.5	+5.0	+5.5	V	【Note 6-1】
	Current dissipation	ISH	-	28	60	mA	【Note 6-2】
+10V	Supply voltage	VGH	+9.5	+10.0	+10.5	V	
	Current dissipation	IGH	-	25	32	mA	【Note 6-2】
- 10V	Supply voltage	VGL	-9.5	-10.0	-10.5	V	
	Current dissipation	IGL	-	-22	-30	mA	【Note 6-2】
Permissive input ripple		V _{RF}	-	-	100	mVpp	
Input Low voltage		V _{IL}	-	0	0.9	V	
Input High voltage		V _{IH}	2.3	3.3	-	V	【Note 6-3】
Input current (Low)		I _{IL}	-	-	1.0	μA	V _I =0V 【Note 6-3】
Input current (High)		I _{IH}	-	-	1.0	μA	V _I =3.3V 【Note 6-3】

Turn on :VGL VSH VGH or same time
Turn off :VGH VSH VGL or same time

【Note 6-1】

VSH-turn-on conditions

- t1 10ms
- 0<t2 10ms
- 0<t3 1s

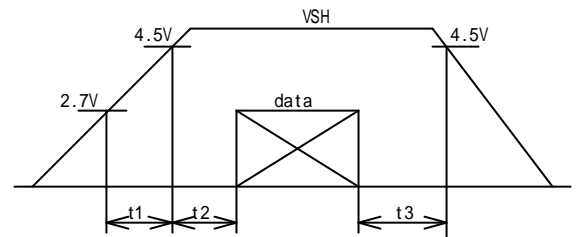

VSH-dip conditions

VSH-dip conditions should also follow the VSH-turn-on conditions.

【Note 6-2】

Typical current situation:64-gray-bar pattern Timing; CK=25MHz

Max current situation: Vertical stripe pattern alternating 21 gray scale (GS21) with 42 gray scale (GS42)

every 1 dot. Timing; CK=25MHz

VSH=+5.0V VGH=+10V VGL= - 10V HVR="High"

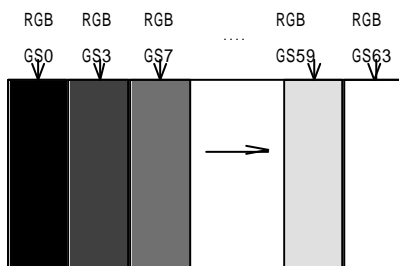

Typical current situation

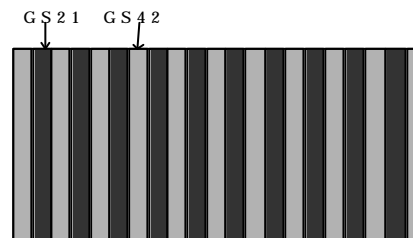

Max current situation

【Note 6-3】 CK,R0 ~ R5,G0 ~ G5,B0 ~ B5,Hsync,Vsync,ENAB,HVR

6-2) Backlight driving section

The backlight system is an edge-lighting type with single CCFT (Cold Cathode Fluorescent Tube). The characteristics of Lamp are shown in the following table.

Table 6-2

Parameter	Symbol	MIN	TYP	MAX	Unit	Remarks
lamp voltage	V _L	630	700	770	Vrms	I _L = 6.5mA _{rms}
lamp current	I _L	6.0	6.5	7.0	mA _{rms}	Ordinary state
	I _{LB}	-	-	9.0	mA _{rms}	PWM dimming state 【Note6-1】
lamp frequency	f _L	35	49	100	kHz	
kick-off voltage	V _S	-	-	3000	Vrms	Ta=+25 【Note6-2】
		-	-	3000	Vrms	Ta=-30 ~ +85 【Note6-2】
kick-off voltage	V _{LS}	-	1460	1820	Vrms	Ta=+25 【Note6-2】
		-	1460	1820	Vrms	Ta=-30 ~ +85 【Note6-2】
Ignition time	T _I			1	sec	Ta=+25
				1	sec	Ta=-30

Inverter:HIU-288[Harison Toshiba Lighting Corp.] (Output capacitor :C=12pF,frequency:49kHz)

【Note6-1】 Dimming

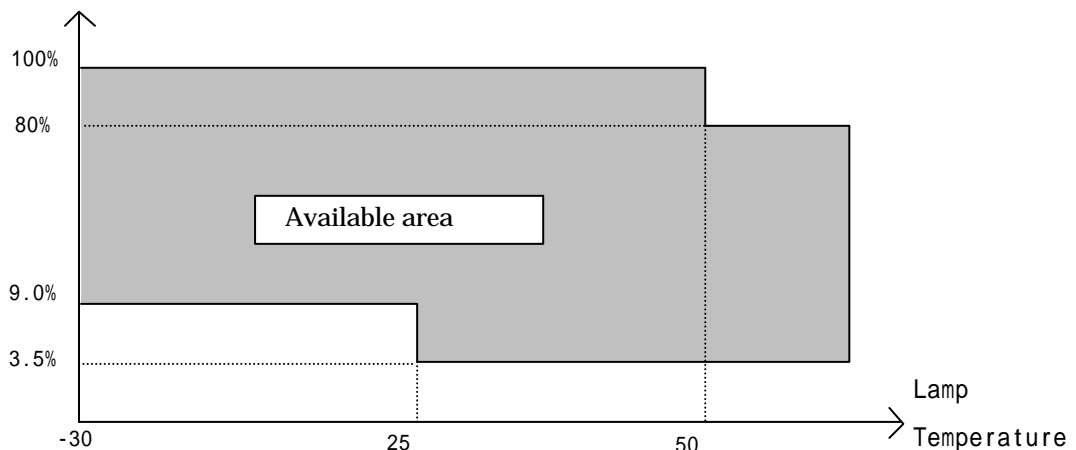

【Note6-2】 The kick-off voltage is specified under the condition in just putting the backlight on the LCD module. (The backlight cable is not unbent.)

The kick-off voltage depends on way to lead the cable between inverter and backlight.

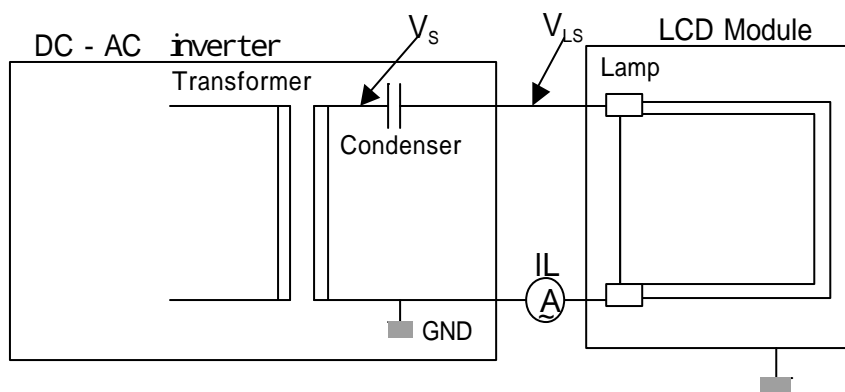

【caution】

Please use the inverter which has the one of the sine wave. With regards to the inverter, it should be negative/positive wave symmetry and the spike wave should not be occurred.

6-3)Lamp Monitoring Interface

Temperature sensor

Thermistor Typ: 203 GT -1 made by Ishizuka Electronics Corporation

According to the spec of the temperature sensor;

$$B = \frac{\ln R1 - \ln R2}{(1/T1 - 1/T2)}$$

T1, T2 : absolute temperature (K)

R1, R2 : Zero load resistance on T1, T2 (ohm)

B : Constant of B (K)

$$R_{25} = 20.00 \text{ k}\Omega \pm 3\%$$

$$B = 4.282\text{K} \pm 2\%$$

Temperature °C	R-Thermistor kΩ (typ)
-50	1901
-45	1304
-40	909.0
-35	637.2
-30	453.2
-25	325.3
-20	236.6
-15	173.2
-10	128.3
-5	95.82
0	72.32
5	55.01
10	42.24
15	32.66
20	25.47
25	20.00
30	15.82
35	12.59
40	10.10
45	8.150
50	6.620
55	5.407
60	4.444
65	3.671
70	3.050
75	2.547
80	2.138
85	1.803
90	1.527
95	1.300
100	1.111
105	0.9530
110	0.8209
115	0.7098
120	0.6160
125	0.5364
130	0.4686
135	0.4108
140	0.3613
145	0.3187
150	0.2820

(Data above is under the condition of B=4.282K and temp=25 to 85 degree C)

(7)Timing Characteristics of input signals

Timing diagrams of input signal are shown in Fig.7-1,2

7-1) Timing characteristics

Table 7-1

Tp=-30 ~ 85

Parameter		Symbol	MIN	TYP	MAX	Unit	Remarks
Clock	frequency	1/Tc	-	-	25	MHz	
	High time	Tch	18	-	-	ns	
	Low time	Tcl	18	-	-	ns	
Data	Setup time	Tds	5	-	-	ns	
	Hold time	Tdh	10	-	-	ns	
Horizontal sync. signal	Cycle	TH	59.1	-	76.92	μs	
			680	800	1675	clock	
	Pulse width	THp	4	48	96	clock	
Vertical sync. signal	Cycle	TV	14.7	16.67	22.65	ms	【Note 7-1】
			260	-	282	line	
	Pulse width	TVp	3	4	128	line	
Horizontal display period		THd	400	400	400	clock	
Vertical display period		TVd	240	240	240	line	
Hsync-Clock phase difference		THc	5	Tc/2	TH - 5	ns	
Hsync-Vsync phase difference		TVh	- 10	-	+10	clock	【Note 7-2】
Vertical display invalid line		TVe	18	18	18	line	

【Note 7-1】 To be driven with more than 50Hz(TV<=20ms).

If less than 50Hz(TV>=20ms),the flicker might be occur gradually.

【Note 7-2】 TH The+673clock

7-2) Horizontal display position

The horizontal display position is determined by ENAB signal.

The input data corresponding to the rising edge of ENAB signal is displayed at the left end of the Active area. (See Fig7-1)

Tp = -30 ~ 85

Parameter		Symbol	MIN.	TYP.	MAX.	Unit	Remark
Enable signal	Setup time	Tes	5	Tc/2	Tc - 5	ns	
	Pulse width	Tep	10	-	TH - 10	clock	
Hsync-Enable signal phase Difference		THE	5	16	256	clock	【Note 7-3】

Note) When ENAB is fixed "Low", the display starts from the data of 16 clock (C16) as shown in Fig.7-2.

【Note 7-3】 THE TH - 673clock

【Note 7-4】 Enable signal must be input into Vertical invalid data period as well as Vertical display period.

7-3) Input Data Signals and Display Position on the screen

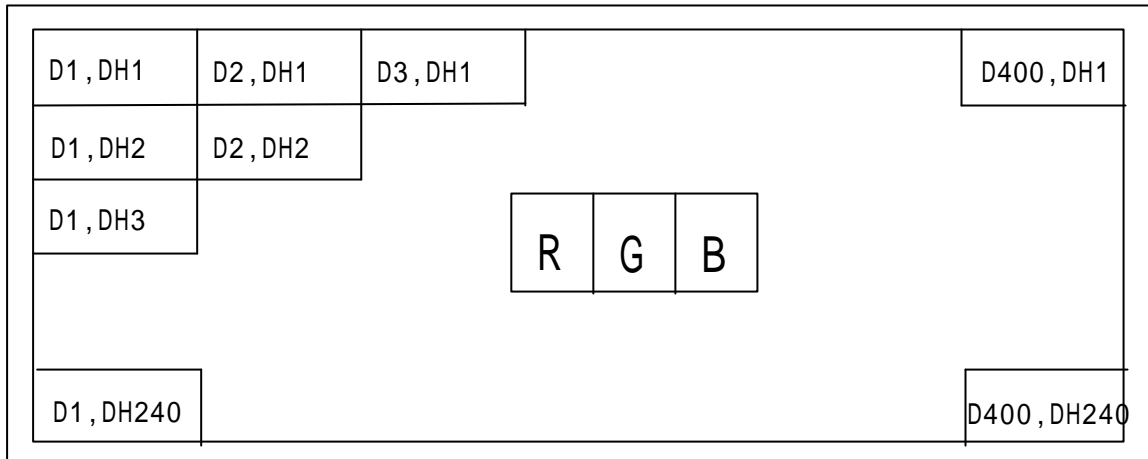

Display position of input data (H,V)

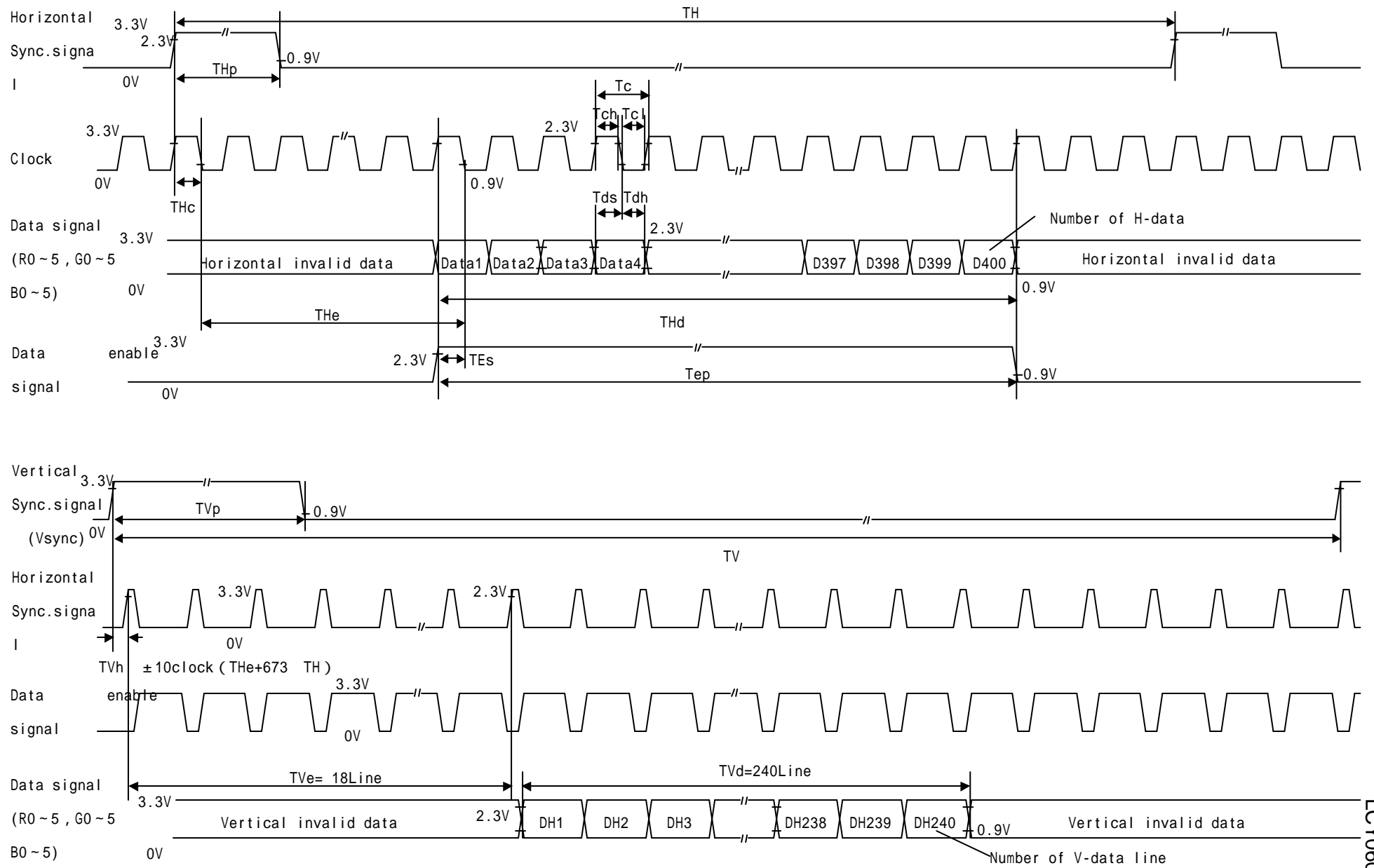

Fig.7-1 Input signal waveforms (ENAB:active)

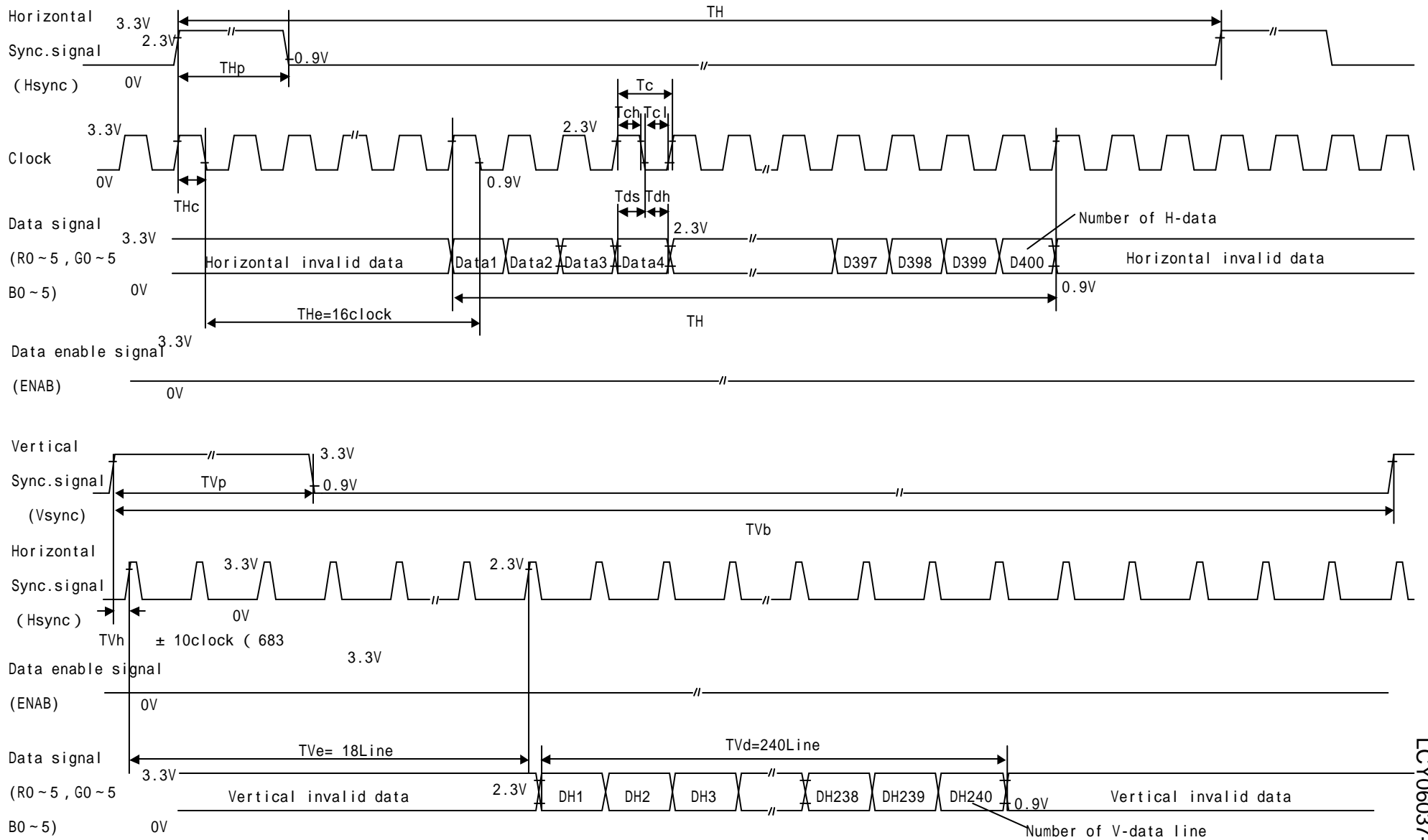

Fig.7-2 Input signal waveforms (ENAB:Lo)

(8) Input Signals, Basic Display Color and Gray Scale of Each Color

	Colors & Gray scale	Data signal																		
		0 :Low level voltage							1 :High level voltage											
	Gray Scale	R0	R1	R2	R3	R4	R5	G0	G1	G2	G3	G4	G5	B0	B1	B2	B3	B4	B5	
Basic color	Black	-	0	0	0	0	0	0	0	0	0	0	0	0	0	0	0	0	0	0
	Blue	-	0	0	0	0	0	0	0	0	0	0	0	0	1	1	1	1	1	1
	Green	-	0	0	0	0	0	0	1	1	1	1	1	1	0	0	0	0	0	0
	Cyan	-	0	0	0	0	0	0	1	1	1	1	1	1	1	1	1	1	1	1
	Red	-	1	1	1	1	1	1	0	0	0	0	0	0	0	0	0	0	0	0
	Magenta	-	1	1	1	1	1	1	0	0	0	0	0	0	1	1	1	1	1	1
	Yellow	-	1	1	1	1	1	1	1	1	1	1	1	1	0	0	0	0	0	0
	White	-	1	1	1	1	1	1	1	1	1	1	1	1	1	1	1	1	1	1
Gray Scale of red	Black	GS0	0	0	0	0	0	0	0	0	0	0	0	0	0	0	0	0	0	0
	↑	GS1	1	0	0	0	0	0	0	0	0	0	0	0	0	0	0	0	0	0
	Darker	GS2	0	1	0	0	0	0	0	0	0	0	0	0	0	0	0	0	0	0
	↑	↓			↓					↓					↓					
	↓	↓			↓					↓					↓					
	Brighter	GS61	1	0	1	1	1	1	0	0	0	0	0	0	0	0	0	0	0	0
	↓	GS62	0	1	1	1	1	1	0	0	0	0	0	0	0	0	0	0	0	0
	Red	GS63	1	1	1	1	1	1	0	0	0	0	0	0	0	0	0	0	0	0
Gray Scale of green	Black	GS0	0	0	0	0	0	0	0	0	0	0	0	0	0	0	0	0	0	0
	↑	GS1	0	0	0	0	0	0	1	0	0	0	0	0	0	0	0	0	0	0
	Darker	GS2	0	0	0	0	0	0	0	1	0	0	0	0	0	0	0	0	0	0
	↑	↓			↓					↓					↓					
	↓	↓			↓					↓					↓					
	Brighter	GS61	0	0	0	0	0	0	1	0	1	1	1	1	0	0	0	0	0	0
	↓	GS62	0	0	0	0	0	0	0	1	1	1	1	1	0	0	0	0	0	0
	Green	GS63	0	0	0	0	0	0	1	1	1	1	1	1	0	0	0	0	0	0
Gray Scale of bleu	Black	GS0	0	0	0	0	0	0	0	0	0	0	0	0	0	0	0	0	0	0
	↑	GS1	0	0	0	0	0	0	0	0	0	0	0	0	1	0	0	0	0	0
	Darker	GS2	0	0	0	0	0	0	0	0	0	0	0	0	0	1	0	0	0	0
	↑	↓			↓					↓					↓					
	↓	↓			↓					↓					↓					
	Brighter	GS61	0	0	0	0	0	0	0	0	0	0	0	0	1	0	1	1	1	1
	↓	GS62	0	0	0	0	0	0	0	0	0	0	0	0	0	1	1	1	1	1
	Bleu	GS63	0	0	0	0	0	0	0	0	0	0	0	0	1	1	1	1	1	1

Each basic color can be displayed in 64 gray scales from 6 bit data signals. According to the combination of total 18 bit data signals, the 262,144-color display can be achieved on the screen.

(9)Optical characteristics

Table 9-1

Ta=25 , VSH=+5V,VGH=+10V,VGL= - 10V

Parameter		Symbol	Condition	Min	Typ	Max	Unit	Remarks	
Transmissive mode	Viewing angle range	11/ 12	CR 15	35	45	-	° (degree)	【Note 9-1】	
		21/ 22		40	50	-		【Note 9-11】	
	Contrast ratio	CRmax	Optimal Viewing angle	150	260	-		【Note 9-2】 【Note 9-11】	
	Contrast ratio Perpendicular	= 0 °	Ta = 25	140	180	-			
		= 0 °	Ta = -25		90			Reference	
		= 0 °	Ta = 0		140			Reference	
		= 0 °	Ta = 60		170			Reference	
	Response time	Black White(r) White Black(d)	IL=6.5mArms	= 0 °	-	10	20	ms	【Note 9-3】
				Ta = 25	-	15	30		
				Black L10 L10 Black	-	100	150		
				-	15	30			
		Black White(r) White Black(d)	IL=9mArms	= 0 °	-	15	30		
				Ta = 0	-	25	50		
				Black L10 L10 Black	-	250	370		
				-	40	80			
Black White(r) White Black(d)		IL=9mArms	= 0 °	-	50	100			
			Ta = -20	-	80	160			
			Black L16 L16 Black	-	550	700			
			-	110	150				
Black White(r) White Black(d)		IL=9mArms	= 0 °,Ta = -30	-	130	260			
			-	-	180	360			
Luminance	Y	IL=6.5mArms	180	250	-	cd/m ²	【Note 9-4】		
Uniformity of luminance			-	-	1.43	%	【Note 9-11】		
Cold brightness's standing-up[-20]	Y _{LOW}	IL=9.0mArms	-	40	-	%	【Note 9-5】		
chromaticity	White	IL=6.5mArms	= 0 °	x	0.273	0.313	0.353	【Note 9-4】	
				y	0.289	0.329	0.369		
	Red			x	0.518	0.568	0.618		
				y	0.282	0.332	0.382		
	Green			x	0.250	0.300	0.350		
				y	0.508	0.558	0.608		
	Blue			x	0.100	0.150	0.200		
				y	0.082	0.132	0.182		
Reflective mode	Viewing angle Range	11/ 12/ 21/ 22	CR 4	25	40	-	° (degree)	【Note 9-1】 【Note 9-6】	
		Contrast ratio		CR	5	8		-	
	Response time	Rise	r	-	10	20	ms	【Note 9-3】	
		Fall	d	-	15	30			
	Reflection ratio	Rf1	= 0 °	4.4	5.5	-	%	【Note 9-7】	
	chromaticity	Whit e	= 0 °	IL=6.5mArms	x	0.269	0.319	0.369	【Note 9-8】
					y	0.299	0.349	0.399	
		Red			x	0.501	0.551	0.601	
					y	0.265	0.315	0.365	
		Green			x	0.219	0.269	0.319	
					y	0.493	0.543	0.593	
		Blue			x	0.102	0.152	0.202	
					Y	0.109	0.159	0.209	
	Flicker rate	-	L0 - L31	-	-	30	%	【Note 9-12】	
	Gamma tolerance	L10		0.3	-	0.9			
L32			15	-	24				
Surface reflectance	Rf2		-	0.6	-	%	【Note 9-7】		
Lamp Life time	Ta=+25	-	continuation	10000	-	-	hour	【Note 9-9】	
	Ta=±0	-	intermission	12000	-	-	time	【Note 9-10-1】	

For the lighting-up evaluation of this backlight unit, it uses an inverter.
 HIU-359A-W2[Harison Toshiba Lighting Corp.]

measuring after 30minutes operation. It does the optical measurement of the characteristic in the condition which is equal to the darkroom or this using the way of measuring the following figure.

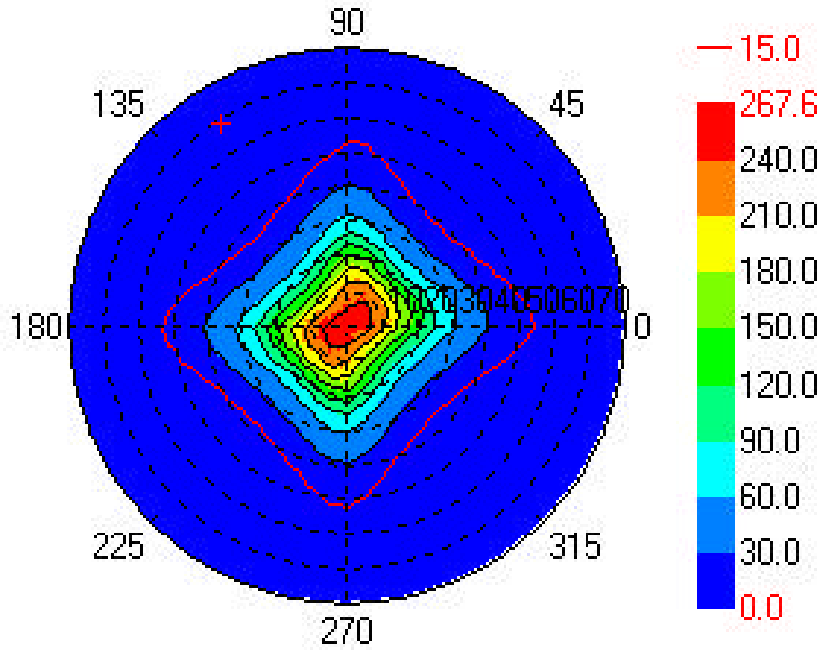

[Note 9-11] Iso-contrast diagram (Ta=25)
 [Reference value]

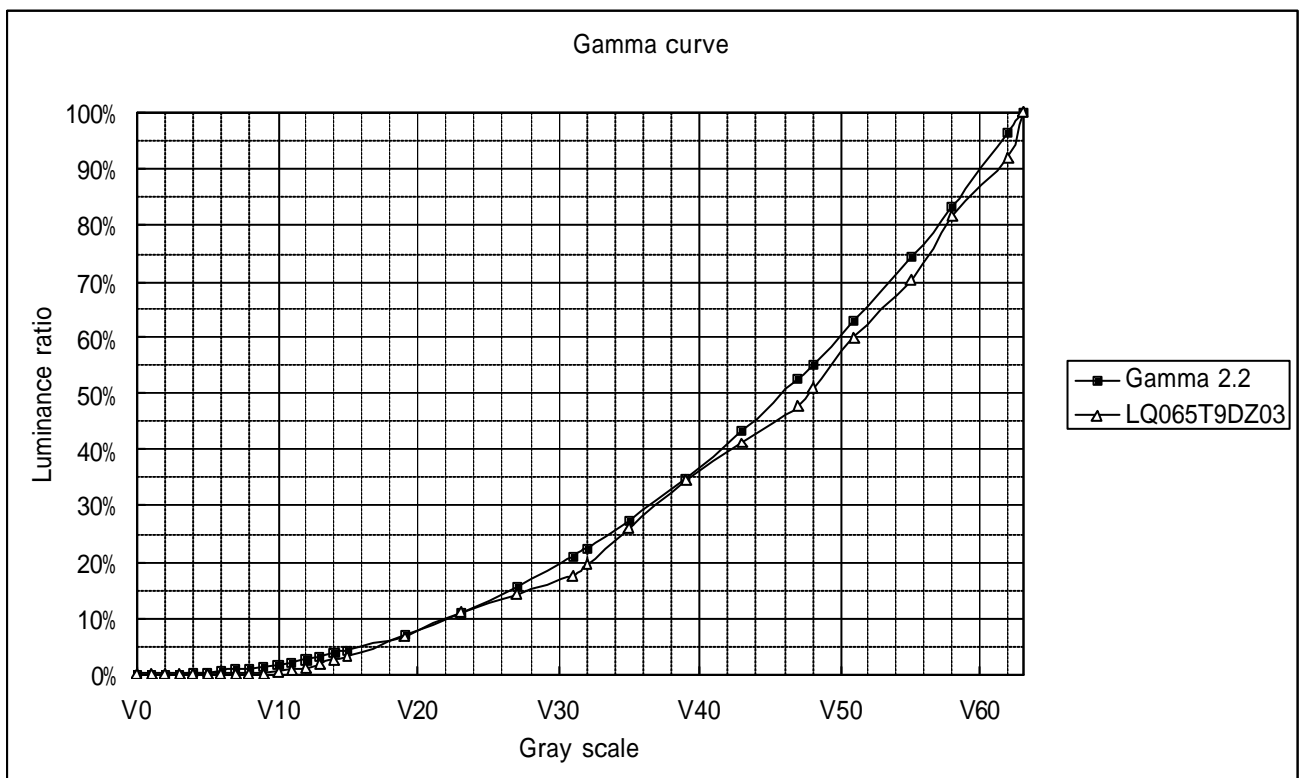

* V0~V63 2.2 Gamma curve & gamma ratio (Ta=25)
 [Reference value]

Table 9-2 Luminance ratio (Reference data)

Gray Scale	LQ065T9DZ03	Gamma 2.2	Gray Scale	LQ065T9DZ03	Gamma 2.2
V0	0.3%	0.0%	V19	6.7%	7.2%
V1	0.3%	0.0%	V23	11.2%	10.9%
V2	0.3%	0.1%	V27	14.3%	15.5%
V3	0.3%	0.1%	V31	17.7%	21.0%
V4	0.3%	0.2%	V32	19.7%	22.5%
V5	0.3%	0.4%	V35	26.0%	27.4%
V6	0.3%	0.6%	V39	34.6%	34.8%
V7	0.3%	0.8%	V43	41.2%	43.2%
V8	0.3%	1.1%	V47	47.6%	52.5%
V9	0.4%	1.4%	V48	50.9%	55.0%
V10	0.6%	1.7%	V51	60.0%	62.8%
V11	0.9%	2.2%	V55	70.3%	74.2%
V12	1.3%	2.6%	V58	81.5%	83.4%
V13	1.8%	3.1%	V62	92.0%	96.5%
V14	2.5%	3.7%	V63	100.0%	100.0%
V15	3.3%	4.3%			

Optical characteristics measurement method (Transmissive mode)

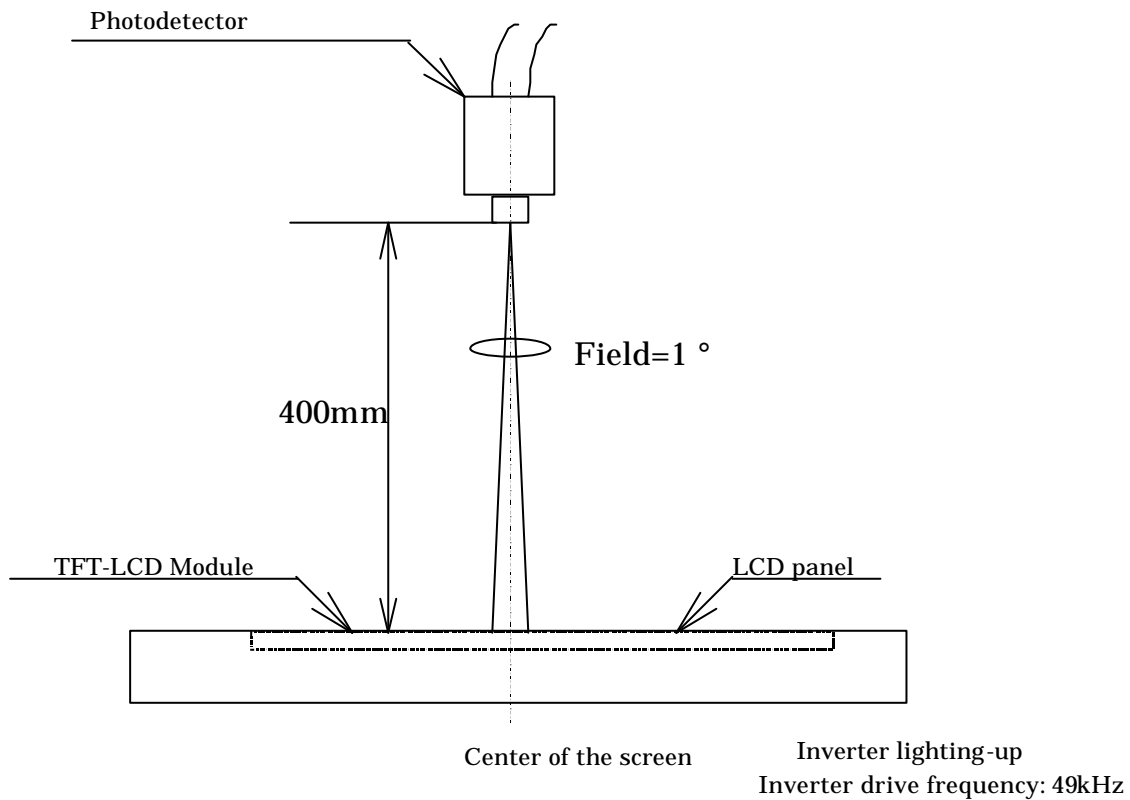

Fig.9-1 Optical characteristics measurement method

Optical characteristics measurement method (Reflection-type mode)

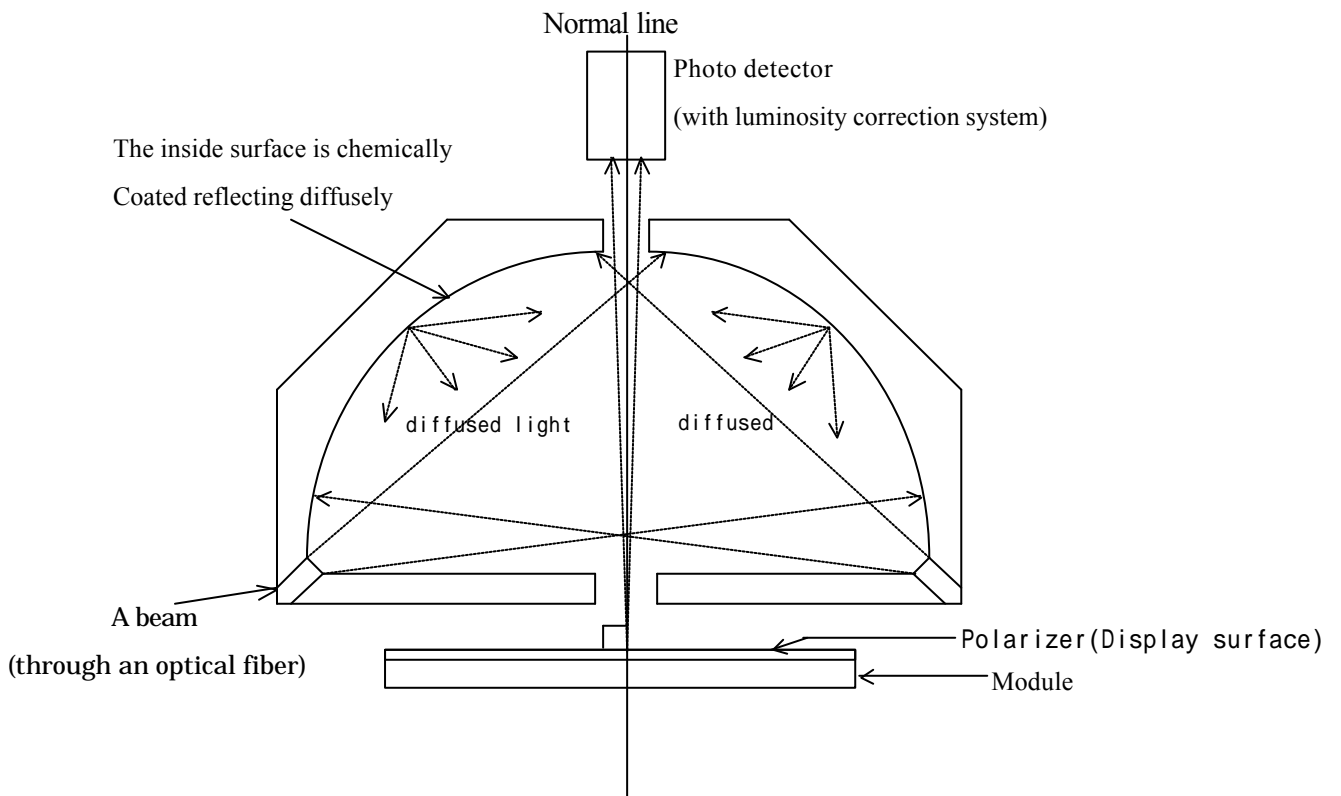
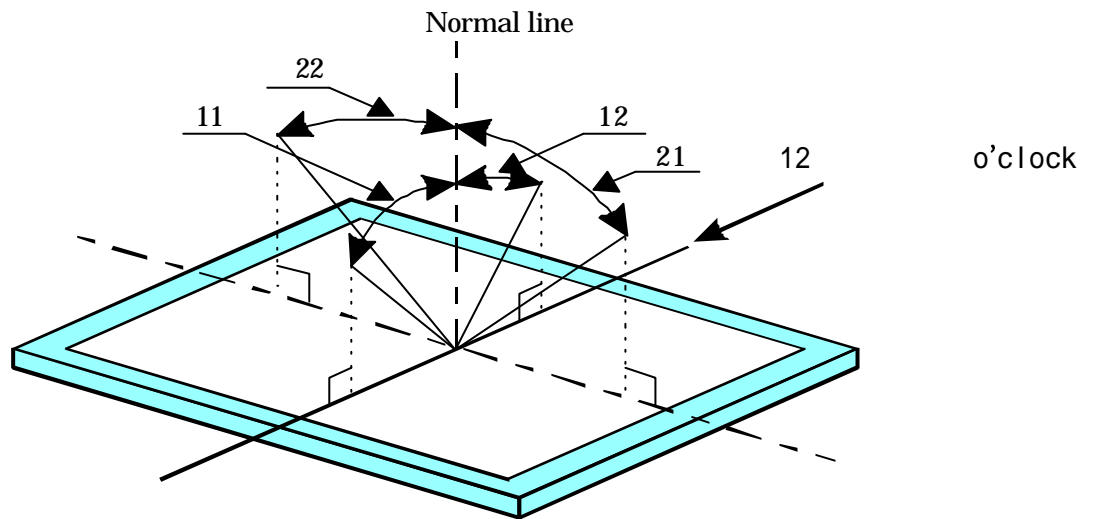

Fig.9-2 Optical characteristics measurement method

【Note 9-1】 Viewing angle range is defined as follows.



definition for viewing angle

【Note 9-2】 Contrast ratio is defined as follows:

$$\text{Contrast ratio(CR)} = \frac{\text{Photo detector output with LCD being "white"}}{\text{Photo detector output with LCD being "black"}}$$

* **ELDIM EZContrast**

【Note 9-3】 Response time is obtained by measuring the transition time of photo detector output, when input signals are applied so as to make the area "black" to and from "white".

For environmental temperature LC response time is measured after module diving and its panel side temperature is stabilized.

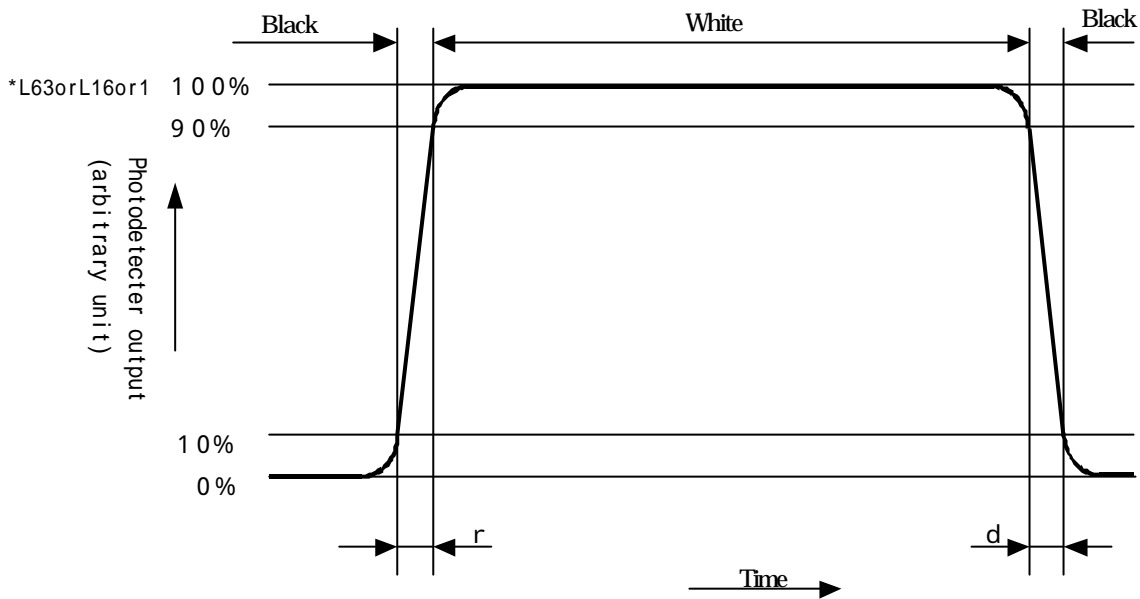

【Note 9-4】 Measured on the center area of the panel at a viewing cone 1° by TOPCON luminance meter BM-7.(After 30 minutes operation)
DC/AC inverter driving frequency: 49kHz

【Note 9-5】 Relative luminance of module stored for sufficient time at - 20 (the module temperature is also - 20)after 2min switching on compared with the luminance at 25 .

【Note 9-6】 Contrast ratio of reflection is defined as follows :

$$\text{Contrast ratio (CR)} = \frac{\text{Photo detector output with all pixels white}}{\text{Photo detector output with all pixels black}}$$

【Note 9-7】 Reflectance is defined as follows:

$$\text{Reflection ratio} = \frac{\text{Light detected level of the reflection by the LCD module}}{\text{Light detected level of the reflection by the standard}} \times 100$$

【Note 9-8】 It is assumed that chromaticity of the light source is (x=0.313,y=0.329).

The measuring system is CM-2002 (with the unit reflecting diffusely) made by MINOLTA co.,ltd.

【Note 9-9】 Lamp life time is defined as the time when either or occurs in the continuous operation under the condition of lamp current $I_L=6.0 \sim 7.0\text{mA}_{rms}$ and PWM dimming 100% ~ 5% ($T_a=25^\circ\text{C}$) Brightness not to become under 50% of the original value.

【Note 9-10】 The ON-OFF number of times that the brightness value on the panel surface doesn't become equal to or less than 50% of the brightness value in the early stages in the following lighting-up condition.

【Note 9-10-1】

(Lighting-up condition)

Ambient temperature: 0

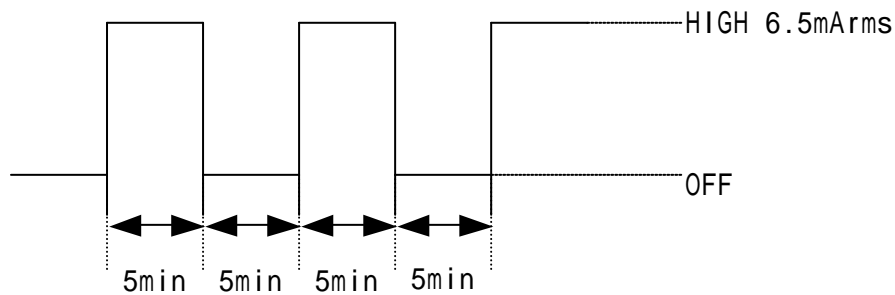

【Note 9-10-2】

(Lighting-up condition)

Ambient temperature: -30

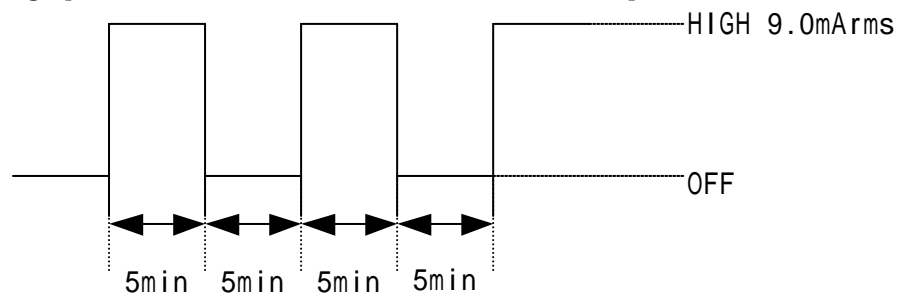

【Note 9-11】 Uniformity of luminance is measured in the measurement part shown in the figure below.
The measurement part is “ ”symbol it shown.

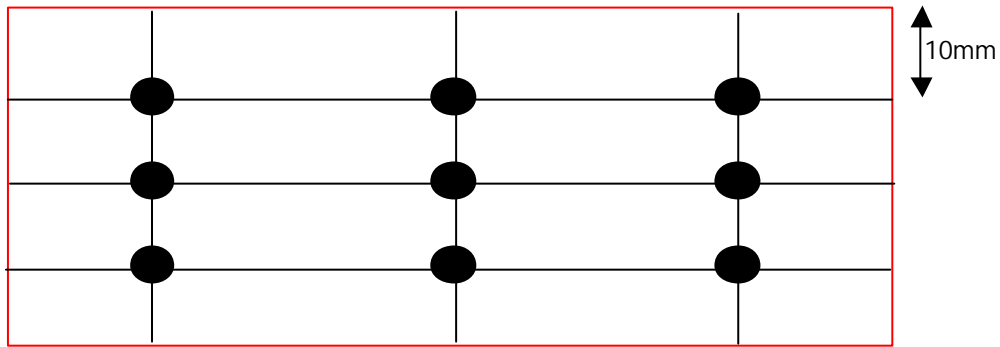

15mm

maximum luminance

Uniformity of luminance

minimum luminance

(Uniformity measurement is not included in SHARP outgoing inspection):

$$C_{pk} = 1.42$$

【Note 9-12】 The flicker rate is provided for under the following condition.

Measurement machine : YOKOGAWA multimedia display tester 3298

Display signal : Stripe pattern of horizontal direction.

Stripe pattern is a pattern that horizontally repeats black(V0) and white(V31) every one line.(V63 is a white step of 100%.)

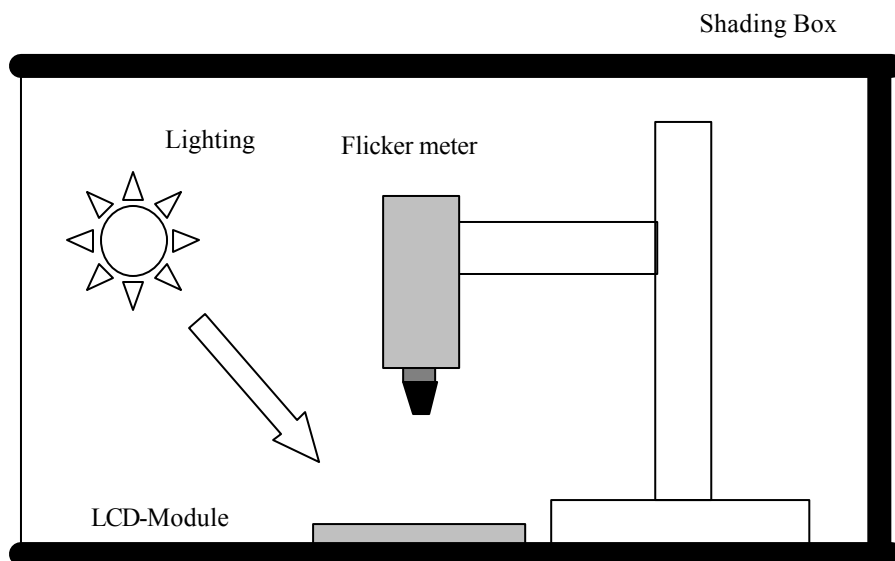

Fig. Measurement environment

(10) Mechanical characteristics

10-1) External appearance

Do not exist extreme defects. (See Fig. 1)

10-2) Panel toughness

The panel shall not be broken, when 19N is pressed on the center of the panel by a smooth sphere having 15 mm diameter.

Caution: In spite of very soft toughness, if, in the long-term, add pressure on the active area, it is possible to occur the functional damage.

(11) Display quality

The display quality of the color TFT-LCD module shall be in compliance with the Incoming Inspection Standards for TFT-LCD.

(12) Handling instructions

12-1) Mounting of module

The TFT-LCD module is designed to be mounted on equipment using the mounting tabs in the four corners of the module at the rear side.

On mounting the module, as the M2.6 tapping screw fastening torque is $0.3 \pm 0.05 \text{ N} \cdot \text{m}$ is recommended, be sure to fix the module on the same plane, taking care not to wrap or twist the module.

Don't reach the pressure of touch-switches of the set side to a module directly, because images may be disturbed.

Please power off the module when you connect the input/output connector.

Please connect the metallic shielding cases of the module and the ground pattern of the inverter circuit surely. If that connection is not perfect, there may be a possibility that the following problems happen.

- a). The noise from the backlight unit will increase.
- b). The output from inverter circuit will be unstable. Then, there may be a possibility that some problems happen.
- c). In some cases, a part of module will heat.
- d). Don't pull a CCFT lead line with the power beyond 10.0N. It has the possibility of the breakage in the lamp, the connection part of the lead line, and so on.
- e). Cold cathode fluorescent lamp in LCD panel contains a small amount of mercury. Please follow local ordinances or regulations for disposal.

12-2) Precautions in mounting

Polarizer which is made of soft material and susceptible to flaw must be handled carefully.

Protection sheet is applied on the surface to protect it against scratches and dirties.

It is recommended to remove the protection sheet immediately before the use, taking care of static electricity.

Precautions in removing the protection sheet

A) Working environment

When the protection sheet is removed off, static electricity may cause dust to stick to the polarizer surface.

To avoid this, the following working environment is desirable.

- a) Floor: Conductive treatment of 1M or more on the tile
(conductive mat or conductive paint on the tile)
- b) Clean room free from dust and with an adhesive mat on the doorway
- c) Advisable humidity: 50% ~ 70% Advisable temperature: 15 ~ 27
- d) Workers shall wear conductive shoes, conductive work clothes, conductive gloves and an earth band.

B) Working procedures

- a) Direct the wind of discharging blower somewhat downward to ensure that module is blown sufficiently. Keep the distance between module and discharging blower within 20 cm.
- b) Attach adhesive tape to the protection sheet part near discharging blower so as to protect polarizer against flaw.
- c) Remove the protection sheet, pulling adhesive tape slowly to your side.
- d) On removing the protection sheet, pass the module to the next work process to prevent the module to get dust.

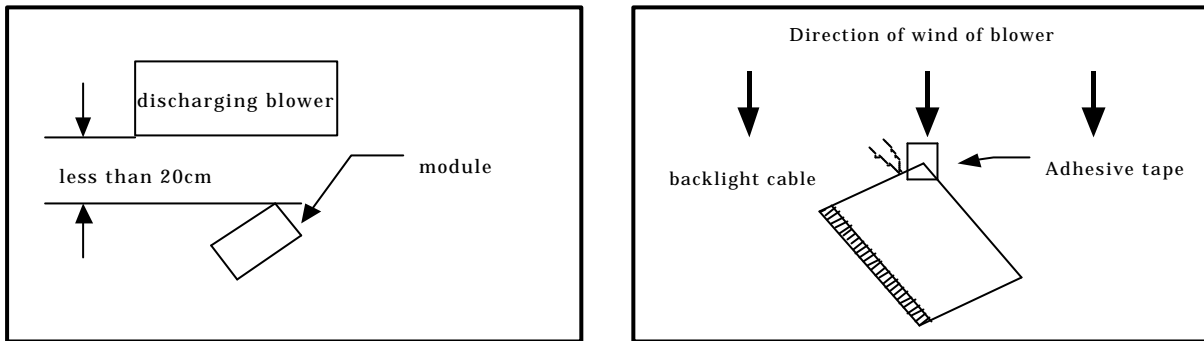

e) Method of removing dust from polarizer

- Blow off dust with N₂ blower for which static electricity preventive measure has been taken.
- Since polarizer is vulnerable, wiping should be avoided.

But when the panel has stain or grease, we recommend to use adhesive tape to softly remove them from the panel.

When metal part of the TFT-LCD module (shielding lid and rear case) is soiled, wipe it with soft dry cloth. For stubborn dirties, wipe the part, breathing on it. Wipe off water drop or finger grease immediately. Long contact with water may cause discoloration or spots. TFT-LCD module uses glass which breaks or cracks easily if dropped or bumped on hard surface. Handle with care. Since CMOS LSI is used in this module, take care of static electricity and earth your body when handling.

12-3) Precautions in adjusting module

Adjusting volumes on the rear face of the module have been set optimally before shipment. Therefore, do not change any adjusted values. If adjusted values are changed, the specifications described here may not be satisfied.

12-4) Caution of product design

The LCD module shall be protected against water salt-water by the waterproof cover.

Please take measures to interferential radiation from module, to do not interfere surrounding appliances.

12-5) Others

Do not expose the module to direct sunlight or intensive ultraviolet rays for several hours; liquid crystal is deteriorated by ultraviolet rays. Store the module at a temperature near the room temperature. At lower than the rated storage temperature, liquid crystal solidifies, causing the panel to be damaged. At higher than the rated storage temperature, liquid crystal turns into isotropic liquid and may not recover. The kick off voltage(lamp) may over the normal voltage because of leakage current from approach conductor. If LCD panel breaks, there may be a possibility that the liquid crystal escapes from the panel. Since the liquid crystal is injurious, do not put it into the eyes or mouth. When liquid crystal sticks to hands, feet or clothes, wash it out immediately with soap. Observe all other precautionary requirements in handling general electronic components.

(13) Packing form

- a) Piling number of cartons : MAX 10
- b) Package quantity in one carton 30 pcs
- c) Carton size: 573(W) × 373(H) × 273(D) mm
- d) Total mass of one carton filled with full modules: 7.7 kg
- e) Conditions for storage.

Environment

Temperature : 0~ 40

Humidity : 60%RH or less (at 40)

No dew condensation at low temperature and high humidity.

Atmosphere : Harmful gas, such as acid or alkali which bites electronic components and/or wires, must not be detected.

Period : about 3 months

Opening of the package : In order to prevent the LCD module from breakdown by electrostatic charges, please control the room humidity over 50%RH and open the package taking sufficient countermeasures against electrostatic charges, such as earth, etc.

(14) Others

- a) Adjusting volume have been set optimally before shipment, so do not change any adjusted value. If adjusted value is changed, the specification may not be satisfied.
- b) Disassembling the module can cause permanent damage and should be strictly avoided.
- c) Please be careful since image retention may occur when a fixed pattern is displayed for a long time.
- d) Indication of lot number

The lot number is shown on a label. Attached location is shown in Fig.1 (Outline Dimensions).

Indicated contents of the label

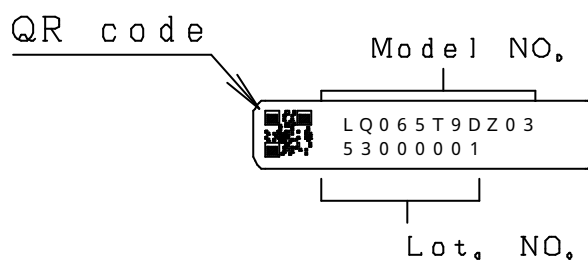

contents of lot No. the 1st figure production year (ex. 2005: 5)
 the 2nd figure production month 1,2,3, ,9,X,Y,Z
 the 3rd ~ 8th figure serial No. 000001 ~

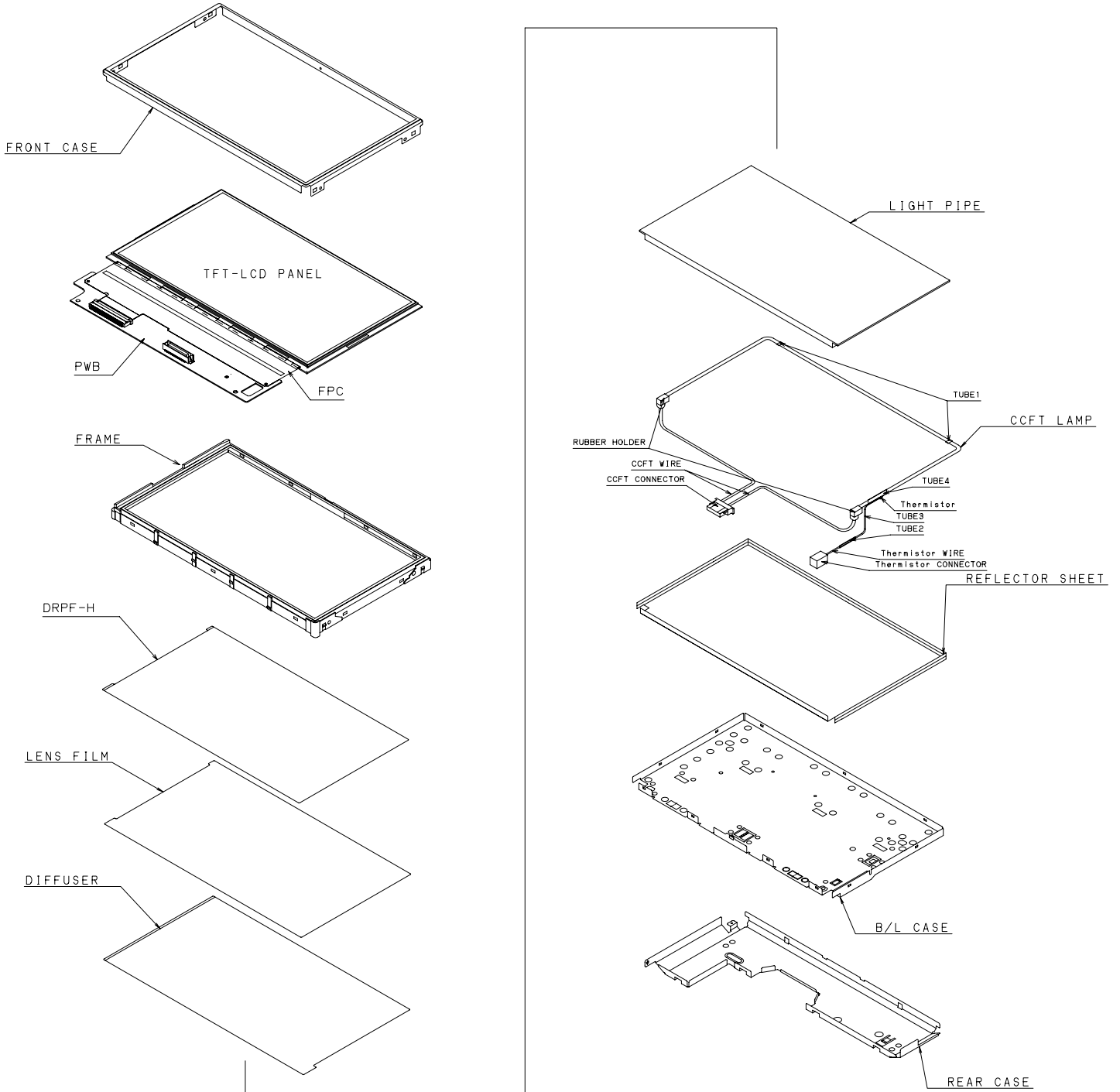

Fig.2 The Construction Form

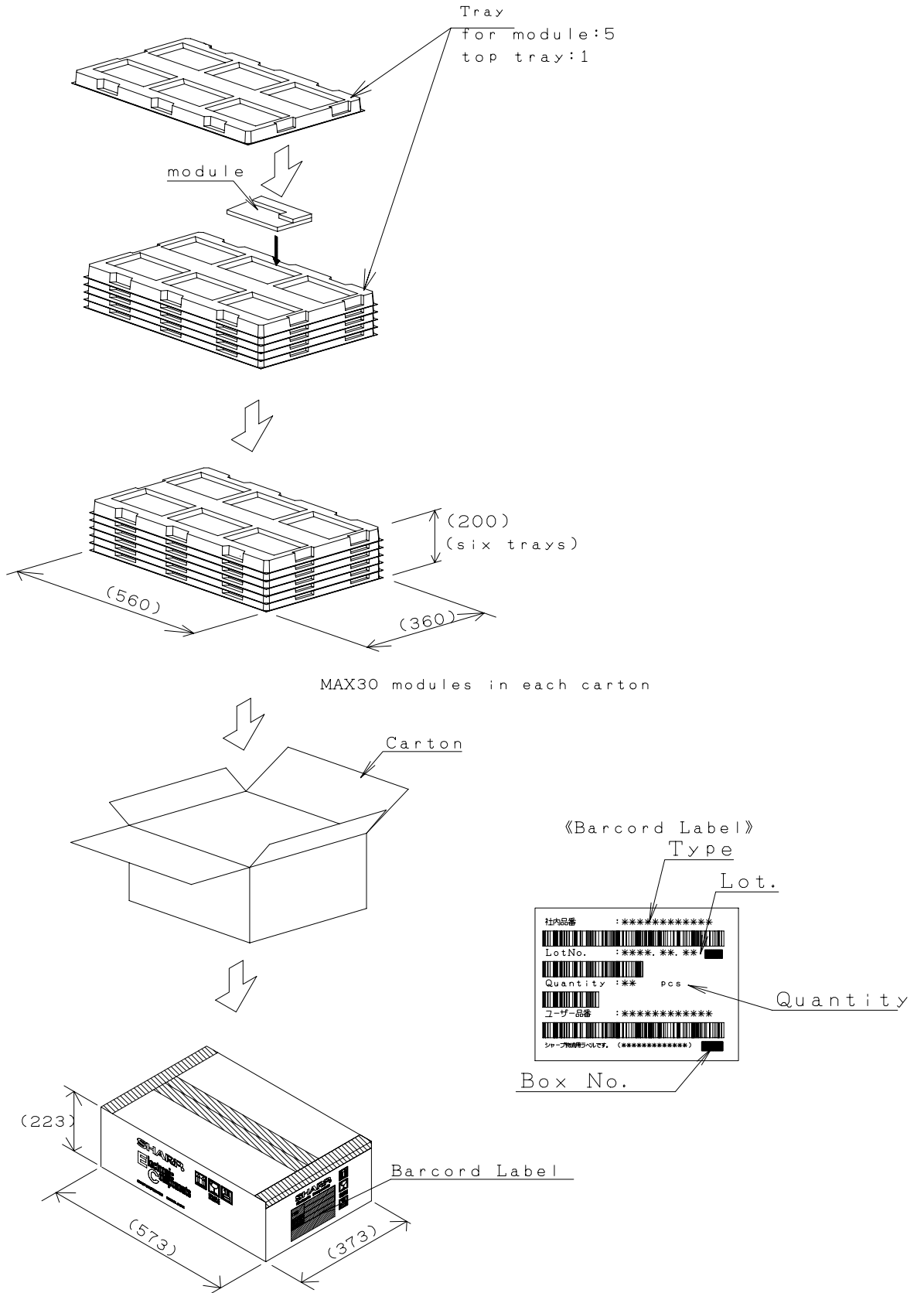

Fig.3 Packing Form