

PREPARED BY: <i>A. Kawada</i>	DATE: 2011 Sep 30	SHARP	SPEC No. LCY-11037B	
APPROVED BY: 	DATE: Sep 30 2011		DISPLAY DEVICE BUSINESS GROUP	FILE No.
			SHARP CORPORATION	ISSUE: Sep. 30. 2011
			SPECIFICATION	PAGE : 29 pages

DEVICE SPECIFICATION FOR
TFT - LCD module
 MODEL No. LQ065Y5DZ01

PRESENTED

BY *T. Makii*
 Toshiyuki Makii
 DEPARTMENT GENERAL MANAGER
 DEVELOPMENT DEPT. II
 LIQUID CRYSTAL DISPLAY DIVISION II
 DISPLAY DEVICE BUSINESS GROUP
 SHARP CORPORATION

NOTICE

This publication is the proprietary of Sharp Corporation (hereinafter referred to as SHARP) and is copyrighted, with all rights reserved. Under the copyright laws, no part of this publication may be reproduced or transmitted in any form or by any means, electronic or mechanical for any purpose, in whole or in part, without the express written permission of SHARP. Express written permission is also required before any use of this publication may be made by a third party.

The application circuit examples in this publication are provided to explain the representative applications of SHARP's devices and are not intended to guarantee any circuit design or permit any industrial property right or other rights to be executed. SHARP takes no responsibility for any problems related to any industrial property right or a third party resulting from the use of SHARP's devices, except for those resulting directly from device manufacturing processes.

In the absence of confirmation by device specification sheets, SHARP takes no responsibility for any defects that occur in equipment using any of SHARP's devices, shown in catalogs, data books, etc. Contact SHARP in order to obtain the latest device specification sheets before using any SHARP's device.

SHARP reserves the right to make changes in the specifications, characteristics, data, materials, structures and other contents described herein at any time without notice in order to improve design or reliability. Contact SHARP in order to obtain the latest specification sheets before using any SHARP's device. Manufacturing locations are also subject to change without notice.

Observe the following points when using any device in this publication. SHARP takes no responsibility for damage caused by improper use of the devices.

The devices in this publication are designed for use in general electronic equipment designs, such as:

- Car Navigation system •Automotive auxiliary information display
- Automotive audio visual equipment

The appropriate design measures should be taken to ensure reliability and safety when SHARP's devices are used for equipment such as:

- Transportation control and safety equipment (i.e. aircraft, trains, automobiles, etc.)
- Traffic signals •Gas leakage sensor breakers
- Alarm equipment •Various safety devices etc.

SHARP's devices shall not be used for equipment that requires extremely high level of reliability, such as:

- Military and space applications •Nuclear power control equipment
- Medical equipment for life support

Contact a SHARP representative, in advance, when intending to use SHARP's devices for any "specific" applications other than those recommended by SHARP.

Contact and consult with a SHARP representative if there are any questions about the contents of this publication.

1. General

This TFT-LCD module is a color active matrix LCD (Liquid Crystal Display) module of transmissive type incorporating amorphous silicon TFT (Thin Film Transistor).

General specification of the module is shown in the Table 3-1.

It is composed of a color TFT-LCD panel, driver ICs, PWB, FPC(between color TFT-LCD panel and control PWB),shielding back case, front case, backlight unit.

2. Features

- Utilizes a panel with a 15:9 aspect ratio, which makes the module suitable for use in wide-screen systems.
- The 6.5 inch screen produces a high resolution image that is composed of 384,000 pixels in a vertical stripe arrangement.
- Graphics and texts can be displayed on a 800×RGB×480 dots panel with 16,194,277 colors by supplying 24 bits (8 bits×RGB) data signal. FRC technology is used for this LCD module.
- Wide viewing field angle technology is employed.
- By adopting an active matrix drive, a picture with high contrast is realized.
- Reduced reflection as a result of low reflection black matrix and an antiglare (AG) and antireflection (AR) polarizer being adopted. The polarizer reflectance is 1.5% Typical.
- By COG method, realized a slim, lightweight, and compact module.
- Realizes a high quality natural color appearance by adopting “Normally Black LC Mode”.
- The backlight achieves fast turn on characteristics across the complete automotive temperature range.

3. Mechanical specifications (Dot Composition)

Parameter	Specifications	Units	Remarks
Display format	384,000	pixels	
	800(RGB)W×480H	dots	
Active area	141.6(W)×84.96(H)	mm	
Screen size (Diagonal)	16.51 [6.5 “]	cm	
Dot pitch	0.059(W)×0.177(H)	mm	
Pixel configuration	R,G,B Stripe configuration		
Outline dimension	161.8 (W)×100.6 (H)×15.0(D)	mm	[Note 3-1]
Mass	290 (typ)	g	

[Note 3-1]

Excluding protrusions. Typical values are given.

For detailed measurements and tolerances, please refer to Fig. 1.

4. Input terminal and its function

4-1 TFT-LCD panel driving part : Connector used : FH41-68S-0.5SH(05) (HRS)

Table 4-1

Pin No.	Symbol	Description	Remarks
1	GND	GND for circuit	
2	N.C.	OPEN	
3	VCC	Logical Power Supply (+3.3V power supply)	
4	VCC	Logical Power Supply (+3.3V power supply)	
5	N.C.	OPEN	
6	GND	GND for circuit	
7	THM_LCD	Thermistor to sense module temperature	[Note4-3]
8	LCD ERROR	LCD Error signal	[Note4-5]
9	PON	Display reset signal	
10	VRV	Turning the direction of vertical scanning	[Note4-4]
11	HRV	Turning the direction of horizontal scanning	[Note4-4]
12	GND	GND for circuit	
13	VD	Vertical sync	[Note4-1]
14	HD	Horizontal sync	[Note4-1]
15	DEN	Horizontal Data Enable	[Note4-2]
16	GND	GND for circuit	
17	NCLK	Clock signal for sampling each data signal	
18	GND	GND for circuit	
19	R0	RED data signal (LSB)	
20	R1	RED data signal	
21	GND	GND for circuit	
22	R2	RED data signal	
23	R3	RED data signal	
24	GND	GND for circuit	
25	R4	RED data signal	
26	R5	RED data signal	
27	GND	GND for circuit	
28	R6	RED data signal	
29	R7	RED data signal(MSB)	
30	GND	GND for circuit	
31	G0	GREEN data signal (LSB)	
32	G1	GREEN data signal	
33	GND	GND for circuit	
34	G2	GREEN data signal	
35	G3	GREEN data signal	
36	GND	GND for circuit	
37	G4	GREEN data signal	
38	G5	GREEN data signal	

39	GND	GND for circuit	
40	G6	GREEN data signal	
41	G7	GREEN data signal(MSB)	
42	GND	GND for circuit	
43	B0	BLUE data signal (LSB)	
44	B1	BLUE data signal	
45	GND	GND for circuit	
46	B2	BLUE data signal	
47	B3	BLUE data signal	
48	GND	GND for circuit	
49	B4	BLUE data signal	
50	B5	BLUE data signal	
51	GND	GND for circuit	
52	B6	BLUE data signal	
53	B7	BLUE data signal(MSB)	
54	GND	GND for circuit	
55	BL_ERROR	Backlight Error signal	[Note4-5]
56	BL_PWM	PWM control for LED driver	
57	N.C.	OPEN	
58	B+	POWER for LED circuit	
59	B+	POWER for LED circuit	
60	B+	POWER for LED circuit	
61	B+	POWER for LED circuit	
62	B+	POWER for LED circuit	
63	N.C.	OPEN	
64	GND	GND for circuit	
65	GND	GND for circuit	
66	GND	GND for circuit	
67	THM_BL	Thermistor to sense backlight temperature	[Note4-3]
68	GND	GND for circuit	

[Note4-1]

Hsync	Negative polarity
Vsync	Negative polarity

[Note4-2] The horizontal display starting position is settled in accordance with a rising timing of DEN signal. (Refer to Fig.2)
 In case DEN is fixed to "Low", the horizontal display starting position is determined as described in Fig.2.(Don't keep DataEn "High" during operation.)

[Note4-3] THM_LCD parts number : NSM2103F344F3 (OHIZUMI)
 THM_BL parts number : NSS4103F39F (OHIZUMI)

THM_LCD and THM_BL connections are shown below:

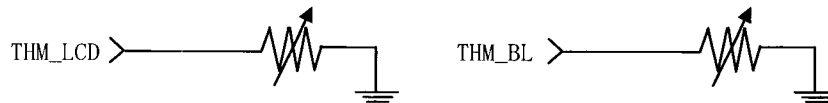

[Note4-4]

HRV="Hi" : Regular video
 HRV="Lo" : Horizontally inverted video
 The HRV signal is pulled up to 3.3V through a 100KΩ resistor within ASIC and pulled up to 3.3V through a 10KΩ on the PCB board.

VRV="Hi" : Regular video
 VRV="Low" : Vertically inverted video
 The VRV signal is pulled up to 3.3V through a 100KΩ resistor within ASIC and pulled up to 3.3V through a 10KΩ on the PCB board.

When they are used with OPEN, the display shows regular video.

[Note4-5]

LCD error signal is active "Lo"
 BL error signal is active "Lo"

LCD error pin and BL error pin are set as Open-drain.
 If these pins are pulled up, please insert the pull-up resistor (10KΩ) in these line.

Refer to Appendix A for functional description of LCD_Error and BL_Error pins.

5. Absolute maximum ratings

Table 5-1

GND=0V

Parameter	Symbol	MIN	MAX	Unit	Note
Input voltage for back light	VB+	-0.3	21.0V	V	
+3.3V power supply	Vcc	-0.3	+4.6	V	
Input signal voltage 1	Vi1	-0.3	Vcc+0.3	V	[Note5-1]
Input signal voltage 2	Vi2	-0.3	"VB+" +0.3	V	[Note5-2]
Storage temperature	Tstg	-40	95	°C	[Note5-3,4]
Operating temperature (LCD panel surface)	Topr1	-30	85	°C	[Note5-3,4,5,6]
Operating temperature (Ambient temperature)	Topr2	-40	85	°C	[Note5-6]

[Note5-1] HD , DEN , VD , NCLK , B0~B7 , G0~G7 , R0~R7 , PON , HRV , VRV

[Note5-2] BL_PWM

[Note5-3] This rating applies to all parts of the module and should not be exceeded.

The specified temperature provides the maximum value within 5mm around the module.

[Note5-4] Maximum wet-bulb temperature is to be less than 58°C. Condensation of dew must be avoided as electrical current leaks will occur, causing a degradation of performance specifications.

[Note5-5] The operating temperature only guarantees operation of the circuit. Specifications (contrast ratio, response time and other factors related to display quality) are determining at ambient temperature (Ta=25°C) .

[Note5-6] Ambient temperature when the backlight is lit. (by PWM).

PWM dimming shall operate at Ta ≥ +68°C. (it applies to LCD module with touch panel only)

(See attached below figure)

Do not allow THM_LCD value to fall below 1.3 KΩ

Do not allow THM_BL value to fall below 900Ω

The display reduce performance level between -40°C ≤ Ta ≤ -30°C and +68°C ≤ Ta ≤ +85°C

Countermeasures for heat generation from LCD module such as heat sink are mandatory at customer's system.

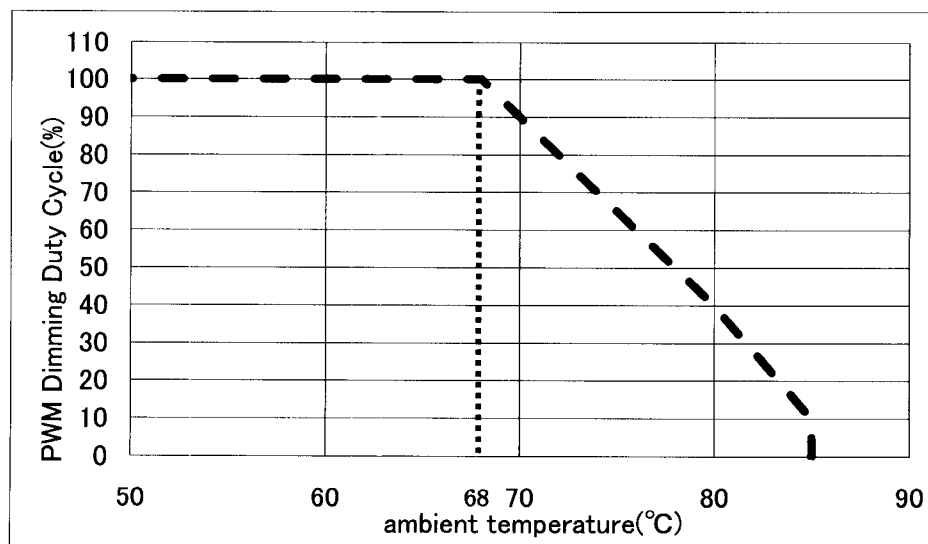

[Note5-7] The above graph is reference data as LCD with touch panel alone.

6. Electrical characteristics
 6-1 TFT-LCD panel driving section
 Table 6-1

Ta= 25°C

Parameter	Symbol	MIN	TYP	MAX	Unit	Remarks
Backlight						
Supply voltage	VB+	7.0	13.5	18.0	V	[Note6-1][Note6-4]
Current dissipation	IB+	—	400	800	mA	Max:VB+=7V
Input Low voltage	V _{IL_PWM}	GND	—	0.4	V	BL_PWM terminal
Input High voltage	V _{IH_PWM}	2.1	—	5.5	V	
Input current (Low)	I _{IL_PWM}	—	—	2.0	μA	V _{IB} =0V or 5.5V
Input current (High)	I _{IH_PWM}	—	—	2.0	μA	"BL_PWM" terminal
Output low voltage	V _{OL_BLE}	GND	—	0.4	V	BL_Error terminal
Leakage current	I _{IL_BLE}	—	—	1.0	μA	"BL_Error"=5.5V
LCD Logic						
Supply voltage	V _{CC}	+3.0	+3.3	+3.6	V	[Note6-1]
Current dissipation	I _{CC}	—	350	400	mA	[Note6-2]
Permissive input ripple	V _{RF}	—	—	100	mVpp	
Input Low voltage	V _{IL1}	GND	—	0.8	V	[Note6-3]
Input High voltage	V _{IH1}	2.0	—	V _{CC}	V	
Negative trigger voltage	V _{NT}	0.6	—	1.8	V	PON terminal
Positive trigger voltage	V _{PT}	1.2	—	2.4	V	
Hysteresis voltage	V _{HYS}	0.5	—	1.0	V	
Input current 1 (Low)	I _{IL1}	—	—	10.0	μA	V _i =0V or V _{CC}
Input current 1 (High)	I _{IH1}	—	—	10.0	μA	[Note 6-3]
Input current 2 (Low)	I _{IL1}	—	—	-64.0	μA	V _i =0V or V _{CC}
Input current 2 (High)	I _{IH1}	—	—	44.0	μA	"HD,VD,DEN"terminal
Input current 3(Low)	I _{IL3}	—	—	-400	μA	V _i = 0V or V _{CC}
Input current 3(High)	I _{IH3}	—	—	64	μA	"HRV,VRV"terminal
Output Low Voltage	V _{OL_LCD}	GND	—	0.4	V	LCD_Error terminal
leakage Current	I _{IL_LCD}	—	—	2.0	μA	LCD_Error =5.5V

[Note6-1]

On-off conditions for supply voltage

- 0 < t₁
- 0 < t₂ ≤ 10ms
- 0 < t₃ ≤ 1s
- t₄ ≥ 1s
- 0 < t₅ ≤ 10ms
- t₆ ≤ 10ms
- 0 ≤ t₇

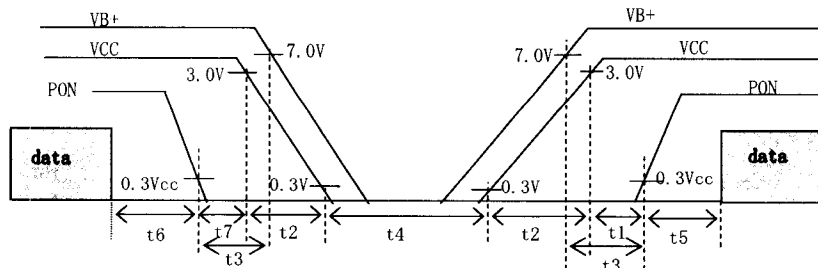

• Voltage drop

- 1) V_{th} ≤ V_{CC} < V_{min}
t_d ≤ 10ms

- 2) V_{CC} < V_{th}

V_{CC}-dip conditions should also follow the On-off conditions for supply voltage

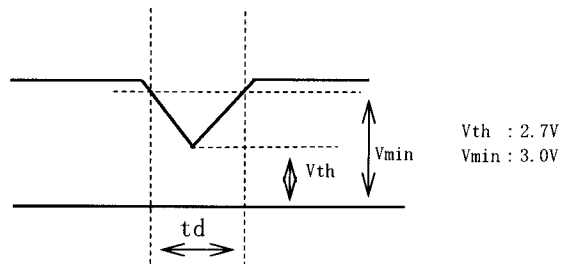

- Every signal is CMOS data, Hi-Z is prohibited when V_{CC} is high level.
- When PON signal turns off, display pattern may be un-controlled for an instance.

[Note6-2]

Typical current situation: Gray scale 253 pattern
 Timing : Typical VCC= +3.3V

[Note 6-3]

NCLK , B0~B7 , G0~G7 , R0~R7

[Note 6-4]

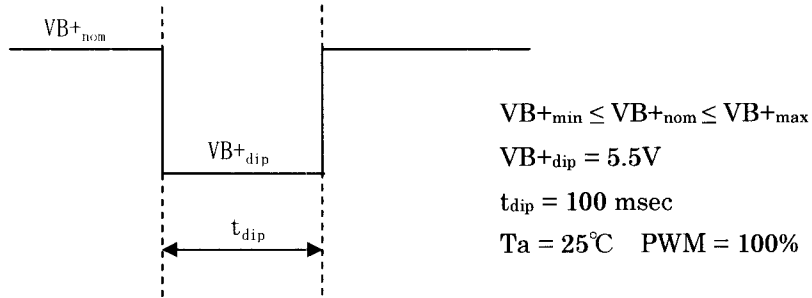

$VB+$ can accept +5.5V for 100msec. $IB+$ is 1.4A, when +5.5V is applied to $VB+$.
 LCD backlight will not blink during $VB+$ dip condition.

7. Timing Characteristics of input signals

7-1) Timing characteristics

Table 7-1

Ta= 25°C

Parameter		Symbol	Min.	Typ.	Max.	Unit	Note
Clock [NCLK]	Frequency	fCLK	31.95	33.26	34.60	MHz	
	Hi_Time	tWCH	5	—	—	ns	
	Lo_Time	tWCL	5	—	—	ns	
Data [I* 0-5]	Setup time	tDS	5	—	—	ns	
	Hold time	tDH	5	—	—	ns	
Horizontal sync.signal [HD]	Cycle	tH(t)	31.45	31.75	32.05	us	
		tH(clk)	1024	1056	1088	ck	
	Pulse width	tHPW	5	—	TH-5	ck	
Vertical sync. Signal [VD]	Cycle	tV	520	525	530	line	
	Pulse width	tVPW	2	—	TV-2	line	
Frame rate	fV	50	60	60	Hz		
Horizontal display period	tHA	800			ck	only 800ck	
HD_NCLK phase difference	tHC	A-8	A	A+8	ns	A=Tc/2 (Tc=1/fCLK)	
HD_VD phase difference	tVH	-10	0	10	ck		
Vertical front porch	tVFP	5	—	—	line		
Vertical back porch	tVBP	35			line	only 35 line	
Vertical display period	tVA	480			line	only 480 line	
Enable signal [HENAB]	Setup time	tES	5	—	—	ns	[Note 7-1]
	Hold time	tEH	5	—	—	ns	
	Pulse width	tEP	800			ck	[Note 7-1] only 800ck
Horizontal front porch	tHFP	2	—	—	ck		
Horizontal back porch	tHBP	194			ck	[Note 7-2] only 194ck	
		20	—	222	ck	[Note 7-3]	
PWM Dimming Frequency	fPWM	150	—	250	Hz	BL_PWM	
PWM Dimming Duty Cycle		1.0	—	100	%		

[Note 7-1] Enable signal must be input into Vertical invalid data period as well as Vertical display period.

[Note 7-2] This spec is applied for DEN Low fix mode.

[Note 7-3] This spec is applied for DEN active mode.

7-2) Input Data Signals and Display Position on the screen
 Refer to the following figure

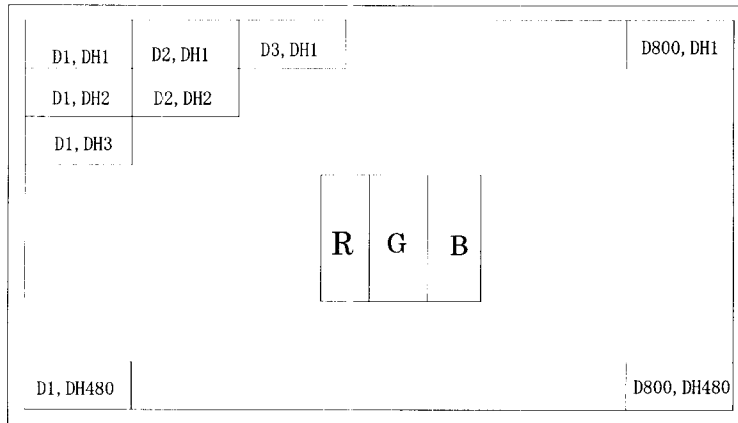

Display position of input data (H,V)

8. Input Signals, Basic Display Color and Gray Scale of Each Color

Table 8-1

Colors & Gray scale	Gray Scale	Data signal																											
		R0	R1	R2	R3	R4	R5	R6	R7	G0	G1	G2	G3	G4	G5	G6	G7	B0	B1	B2	B3	B4	B5	B6	B7				
Basic Color	Black	—	0	0	0	0	0	0	0	0	0	0	0	0	0	0	0	0	0	0	0	0	0	0	0	0			
	Blue	—	0	0	0	0	0	0	0	0	0	0	0	0	0	0	0	0	X	X	1	1	1	1	1	1			
	Green	—	0	0	0	0	0	0	0	0	X	X	1	1	1	1	1	1	0	0	0	0	0	0	0	0			
	Cyan	—	0	0	0	0	0	0	0	0	X	X	1	1	1	1	1	1	X	X	1	1	1	1	1	1			
	Red	—	X	X	1	1	1	1	1	1	0	0	0	0	0	0	0	0	0	0	0	0	0	0	0	0			
	Magenta	—	X	X	1	1	1	1	1	1	0	0	0	0	0	0	0	0	X	X	1	1	1	1	1	1			
	Yellow	—	X	X	1	1	1	1	1	1	X	X	1	1	1	1	1	1	0	0	0	0	0	0	0	0			
	White	—	X	X	1	1	1	1	1	1	X	X	1	1	1	1	1	1	X	X	1	1	1	1	1	1			
Gray Scale of Red	Black	GS0	0	0	0	0	0	0	0	0	0	0	0	0	0	0	0	0	0	0	0	0	0	0	0				
	↑	GS1	1	0	0	0	0	0	0	0	0	0	0	0	0	0	0	0	0	0	0	0	0	0	0				
	Darker	GS2	0	1	0	0	0	0	0	0	0	0	0	0	0	0	0	0	0	0	0	0	0	0	0				
	↑	↓					↓							↓										↓					
	↓	↓					↓							↓										↓					
	Brighter	GS250	0	1	0	1	1	1	1	1	0	0	0	0	0	0	0	0	0	0	0	0	0	0	0				
	↓	GS251	1	1	0	1	1	1	1	1	0	0	0	0	0	0	0	0	0	0	0	0	0	0	0				
	Red	GS252	X	X	1	1	1	1	1	1	0	0	0	0	0	0	0	0	0	0	0	0	0	0	0				
Gray Scale of Green	Black	GS0	0	0	0	0	0	0	0	0	0	0	0	0	0	0	0	0	0	0	0	0	0	0	0				
	↑	GS1	0	0	0	0	0	0	0	0	1	0	0	0	0	0	0	0	0	0	0	0	0	0	0				
	Darker	GS2	0	0	0	0	0	0	0	0	0	1	0	0	0	0	0	0	0	0	0	0	0	0	0				
	↑	↓					↓							↓										↓					
	↓	↓					↓							↓										↓					
	Brighter	GS250	0	0	0	0	0	0	0	0	0	1	0	1	1	1	1	1	0	0	0	0	0	0	0				
	↓	GS251	0	0	0	0	0	0	0	0	1	1	0	1	1	1	1	1	0	0	0	0	0	0	0				
	Green	GS252	0	0	0	0	0	0	0	0	X	X	1	1	1	1	1	1	0	0	0	0	0	0	0				
Gray Scale of Blue	Black	GS0	0	0	0	0	0	0	0	0	0	0	0	0	0	0	0	0	0	0	0	0	0	0	0				
	↑	GS1	0	0	0	0	0	0	0	0	0	0	0	0	0	0	0	1	0	0	0	0	0	0	0				
	Darker	GS2	0	0	0	0	0	0	0	0	0	0	0	0	0	0	0	0	1	0	0	0	0	0	0				
	↑	↓					↓							↓										↓					
	↓	↓					↓							↓										↓					
	Brighter	GS250	0	0	0	0	0	0	0	0	0	0	0	0	0	0	0	0	0	1	0	1	1	1	1				
	↓	GS251	0	0	0	0	0	0	0	0	0	0	0	0	0	0	0	0	1	1	0	1	1	1	1				
	Blue	GS252	0	0	0	0	0	0	0	0	0	0	0	0	0	0	0	0	X	X	1	1	1	1	1				

0 : Low level 1:High level X : Don't care

Each basic color can be displayed in 253 gray scales by 8 bit data signals. According to the combination of total 24 bit data signals, the 16,194,277 million-color display can be achieved on the screen.

9. Optical characteristics

Table 9-1

Ta=25°C , Vcc=+3.3V , VB+=13.5V , BL_PWM=100% ,Initial Value

Parameter	Symbol	Condition	Min	Typ	Max	Unit	Remarks	
Viewing Angle Range	θ21,θ22	CR≥ 10	70	85	-	degree	【Note 9-1,2】	
	θ11,θ12		70	85	-	degree		
Contrast ratio	CRmax	θ=0°	1100	1700	-		【Note 9-2】	
Response time	Rise		τr	-	15	35	ms	【Note 9-3】
	Fall		τd	-	5	15	ms	
Color Chromaticity	x (white)		0.255	0.290	0.330			±0.03 NTSC ratio is Typ(64)%.
	y (white)		0.280	0.320	0.360			
	x (red)		0.592	0.622	0.652			
	y (red)		0.318	0.348	0.378			
	x (green)		0.290	0.320	0.350			
	y (green)		0.585	0.615	0.645			
	x (blue)	0.120	0.150	0.180				
y (blue)	0.060	0.090	0.120					
Luminance	Y		500	675	-	cd/m ²		
Off-Axis Half Brightness	θ21,θ22	-	35	45	-	degree	【Note 9-1】	
	θ11,θ12	-	20	30	-	degree		
Uniformity	u	-	-	85	-	%	【Note 9-5】	
LED lifetime	+25°C	continuation	10,000	-	-	hour	【Note9-4】	

※Above specification warrants only initial condition.

※Measured after 30 minutes operation. The optical characteristic is measured by using the method of fig.6 and fig.7 under the condition of the darkroom or equivalent to it.

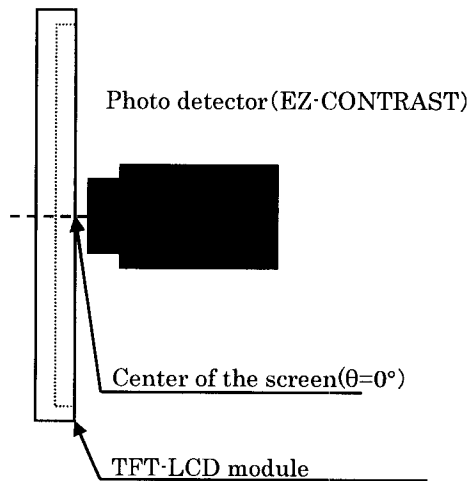

Fig. 6 The way of measuring Viewing angle range/ Response time

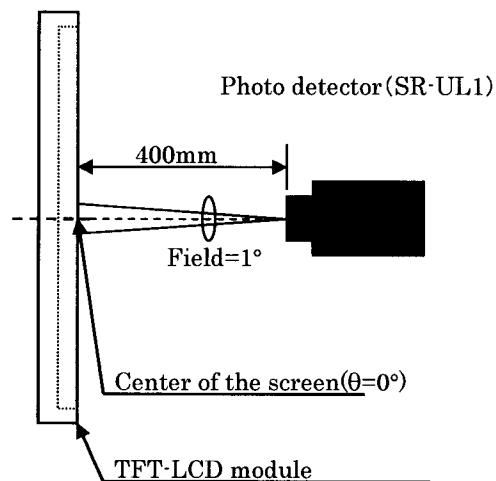
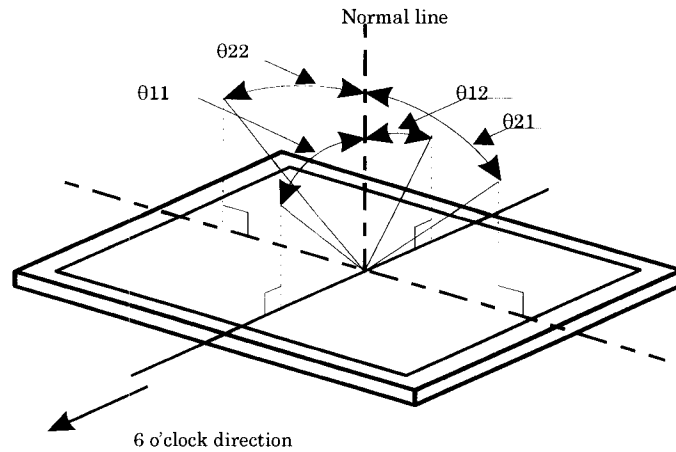

Fig. 7 The way of measuring Luminance/ Chromaticity/ Contrast

[Note9-1] Viewing angle range is defined as follows.



[Note9-2] Contrast ratio of transmission is defined as follows:

$$\text{Contrast ratio (CR)} = \frac{\text{Photo detector output with LCD being "white"}}{\text{Photo detector output with LCD being "black"}}$$

[Note9-3] Response time is obtained by measuring the transition time of photo detector output, when input signals are applied so as to make the area "black" to and from "white".

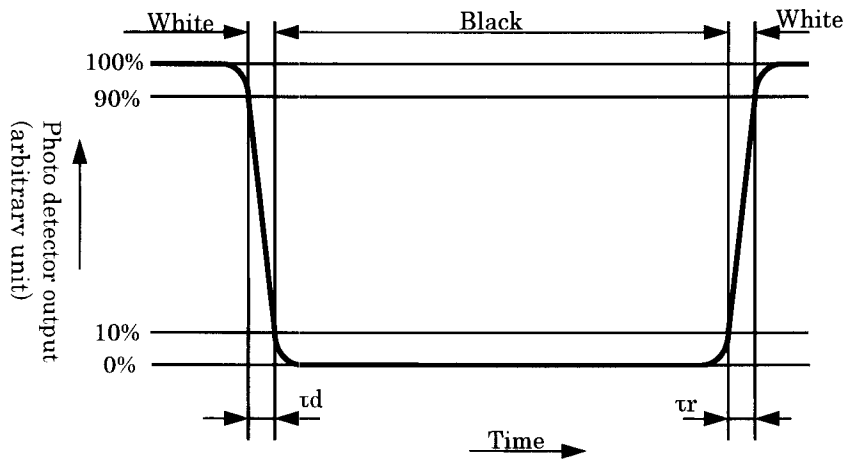

[Note9-4] LED life time is defined as the time when the brightness of the panel is not become less than 50% of the original value in the continuous operation under the condition of LED current $I_f = 70\text{mA}$ and PWM dimming 100%~5% ($T_a = 25^\circ\text{C}$).

[Note9-5] $u=Y_{min}/Y_{max}$: (9points luminance)

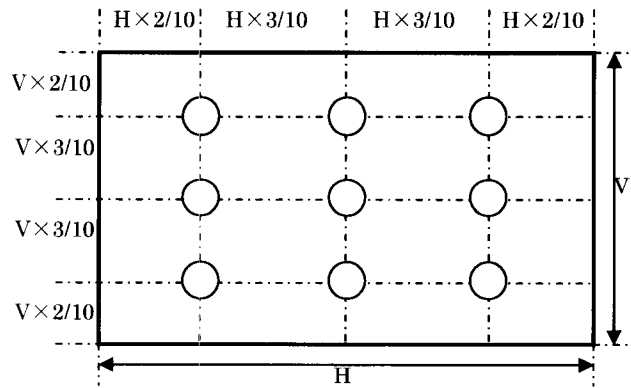

[Note 9-6] The tolerance of color chromaticity of white is shown as follows

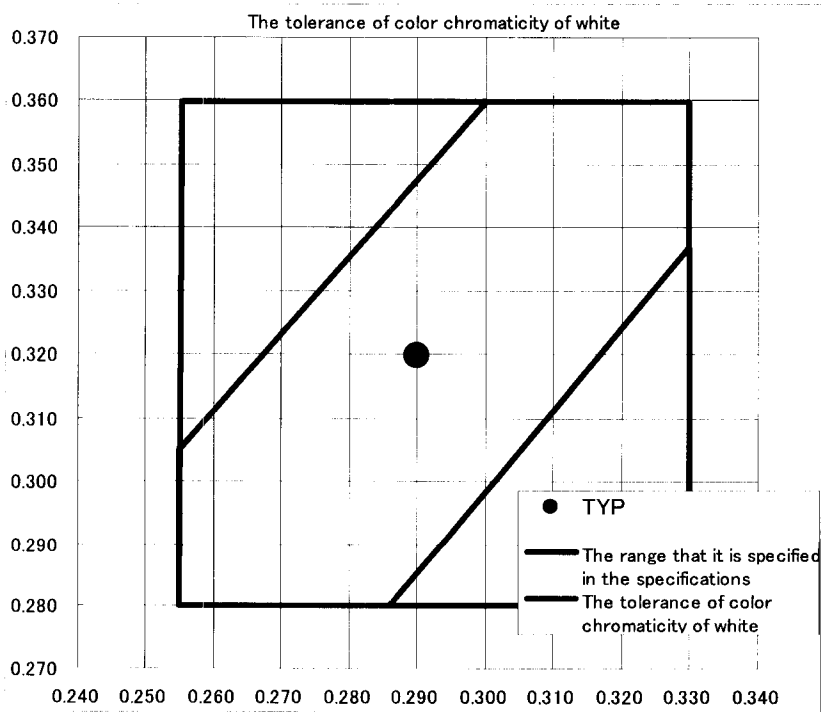

10. Display quality

The display quality of the module shall be in compliance with the Incoming Inspection Standards. Please reference document number LDIE-065YFO01.

11. Mechanical characteristics

11-1 External appearance

No extreme defect exists. (See Fig. 1)

11-2 LCD Panel toughness

The LCD panel shall not be broken, when 19N is pressed on the center of the panel by a smooth sphere having 15 mm diameter.

Caution: In spite of very soft toughness, continuous pressure on the active area may cause functional damage.

12. Handling instructions

12-1 Mounting of module

- The TFT-LCD module is designed to be mounted on hardware using the mounting features that are located on the back side of the module.
- Side mount features may also be used with back side mounting.
- When mounting the module, M2.5 tapping type screw (fastening torque is TYP (0.4)N·m(design target)) is recommended for back side, M2.5 type screw (fastening torque is TYP (0.4)N·m(design target)) is for side mount. Take care to mount the module on the same plane. Take caution not to warp or twist the module during mounting.
- Do not apply pressure on the front surface of the glass or metal frame of the LCD module as this could cause the image to be distorted.
- Always turn the power off to the module when connecting or disconnecting the flex cable to the main connector.
- Please ensure that the LCD metal case is grounded in the system design.

12-2 Precautions in mounting

- The polarizer is made of soft material and is susceptible to damage. Please handle the module carefully.
- A protective sheet is applied on the surface of the module to protect it against scratches and dirt.
- It is recommended to remove the protective sheet just before assembly or use. ESD precaution should be used during the removal of the sheet.
- Precautions in removing the protection sheet:

A) Working environment

When the protection sheet is removed, static electricity may cause dust to stick to the polarizer surface. To avoid this, the following working environment is recommended:

- Floor: Conductive treatment of $1M\Omega$ or more on the tile (conductive mat or conductive paint on the tile)
- Clean room free from dust and with an adhesive mat in the doorway
- Recommended humidity: 50%~70% Recommended temperature: 15C~27C
- Workers shall wear conductive shoes, conductive work clothes, conductive gloves and a ground strap.

B) Working procedures

- Use an ionized air supply when removing the protective sheet. Direct the air slightly downward. Keep the distance between the LCD module and the ionized air supply within 20 cm.
- Remove the protective sheet, pulling the tab slowly towards you.
- Immediately after the protective sheet is removed, pass the module to the next work process to prevent the module to get dust.

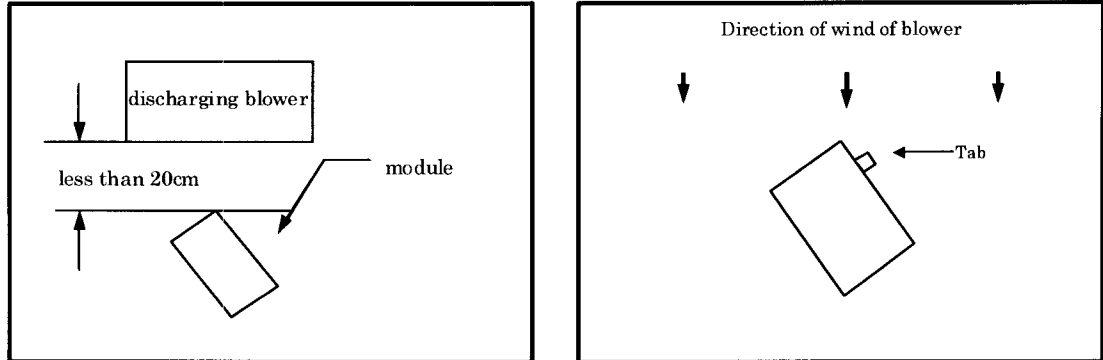

- Method of removing dust from polarizer:
 - Blow off any dust with an N2 blower for which static electricity preventive measure has been taken.
 - Since polarizer is vulnerable to scratches, wiping should be avoided.
 - But when the panel has stain or grease, to use adhesive tape is recommended to remove them softly from the panel.
- When metal part of the TFT-LCD module (shielding lid and rear case) is dirty, wipe it with a soft dry cloth. For stubborn dirt, apply a slight condensation on the metal and then gently wipe it off.
- Wipe off any water drops or finger grease immediately. Prolonged contact with water may cause discoloration or spots.
- The TFT-LCD module contains glass which can break or crack easily if dropped or bumped on a hard surface. Please handle with care.
- Since CMOS devices are used in this product, use ESD precaution when handling such as connecting a ground strap to your body.

12-3 Caution of product design

Please follow the notes below when designing this LCD module into your system.

- The LCD module shall be protected against water or saltwater with a waterproof cover.
- Please apply necessary design methods to not allow the LCD to interfere with surrounding appliances.

12-4 Others

- Liquid crystal is sensitive to ultraviolet rays. Do not expose the module to direct sunlight for a long time.
- Storage of the module under temperatures lower than the specified range may solidify the liquid crystal in the module, resulting in damage to the panel. Storage of the module under temperatures exceeding the specified range may cause an irreversible change of the liquid crystal to the isotropic phase.
- When the LCD is broken, do not ingest the liquid crystal. If any liquid crystal adheres to your skin or clothes, wash it off immediately with soap and water.
- Immediately remove any water droplets or dirt on the polarizer. Failure to do so may cause degradation.
- Observe all other precautionary requirements in handling general electronic components.
- The LCD has been calibrated prior to shipment, do not change any of the adjustable values within the LCD module.

13. Packing form

13-1 The packing form figure : See Fig.4

13-2

a) Piling number of cartons : MAX 8

b) Conditions for storage

Environment

① Temperature : 0~40°C

② Humidity : 60%RH or less (at 40°C)

No dew condensation at low temperature and high humidity.

③ Atmosphere : Harmful gas, such as acid or alkali which bites electronic components and/or wires, must not be detected.

④ Period : about 3 months

⑤ Opening of the package : In order to prevent the LCD module from breakdown by electrostatic charges, please control the room humidity over 50%RH and open the package taking sufficient countermeasures against electrostatic charges, such as earth, etc.

14. Others

14-1) Indication of lot number

① Attached location of the label : See Fig.1 (Outline Dimensions).

② Indicated contents of the label



Contents of model No. the 1st ~11th figure · · model No.
 the 12th · · management division

Contents of lot No. the 1st figure · · production year (ex. 2011 → 1)
 the 2nd figure · · production month 1,2,3,·····,9,X,Y,Z
 the 3rd~8th figure · · serial No. 000001~
 the 9th figure · · revision marks space,A,B,C··

14-2)Pb-free Environmental burden status

This TFT-LCD module is chromium hexavalent-free and Pb-free

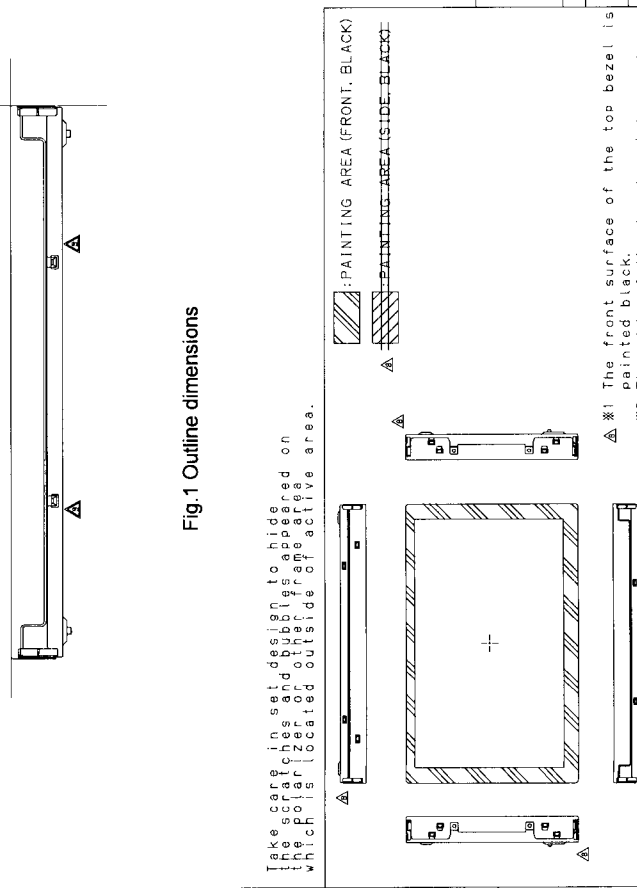
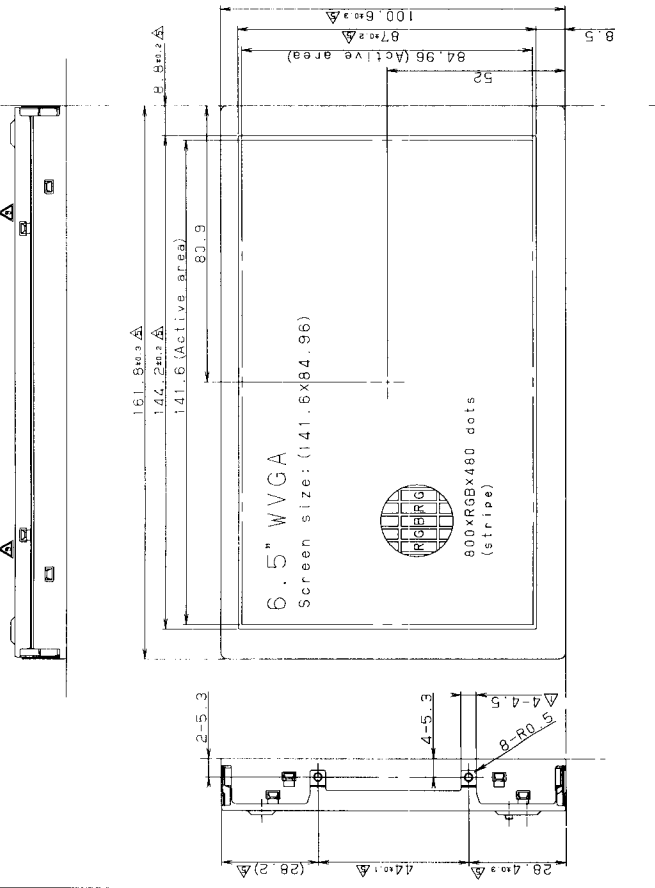
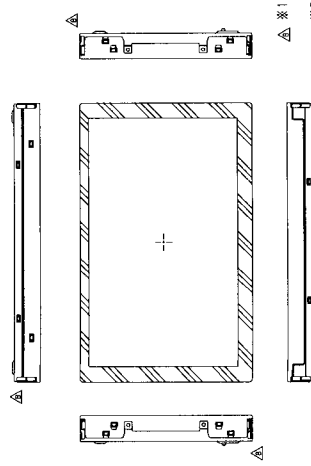

Fig. 1 Outline dimensions

Take care is not to be hidden to be hidden on the surface and be hidden on the surface of other frame active area which is located outside of active area.

PAINTING AREA (FRONT, BLACK)
PAINTING AREA (SIDE, BLACK)



*1 The front surface of the top bezel is painted black.
*2 The side of the top bezel has not cosmetic criteria.

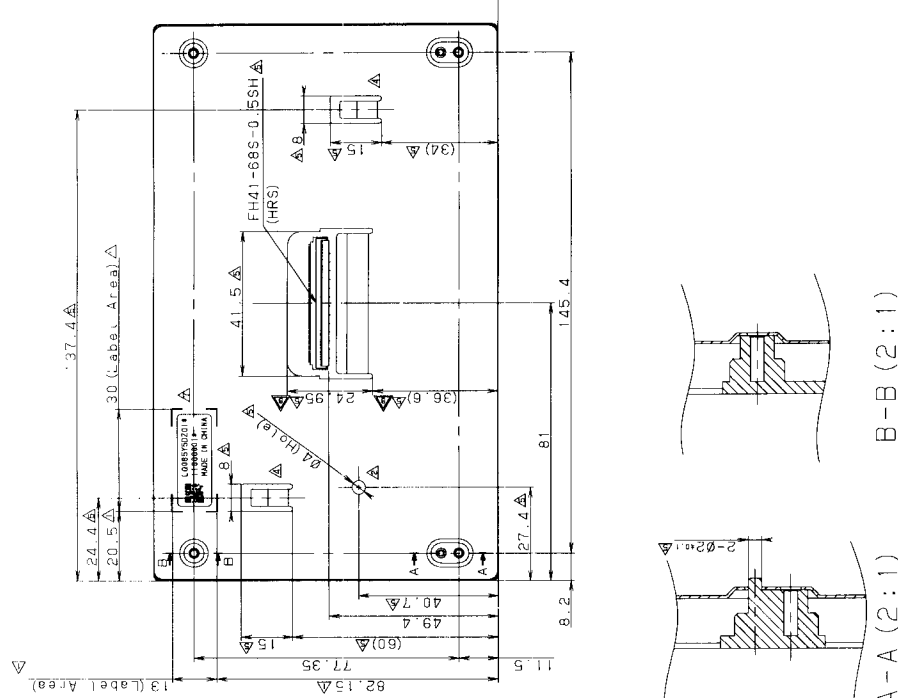

A-A (2:1)

B-B (2:1)

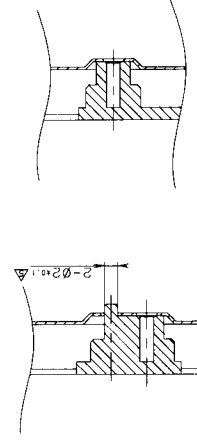

C-C (2:1)

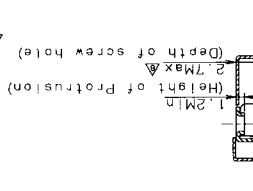

4-M2.5 Protrusion Δ
Recommended Screw: M2.5
Recommended torque: (0.44N·m) [N·m]

4- $\emptyset 2$ Screw hole (Rear)
Recommended Screw: M2.5
Recommended torque: (0.44N·m) [N·m]

CONFIDENTIAL

Since this module is under development, all the specified value is tentative, and the technical specification is subject to change without notice.

Please do not copy this material and do not disclose this to third party.

unit:mm	General tolerance is ± 0.5
DATE	2010.10.26
SCALE	1/1
MODEL	LQ065Y5DZ011
DRAWING NO.	LCM-1100261
SIZE	A2
REVISION	REV. 1
SHARP CORPORATION	LIQUID CRYSTAL DISPLAY DIVISION
ENGINEERING DEPT. I	

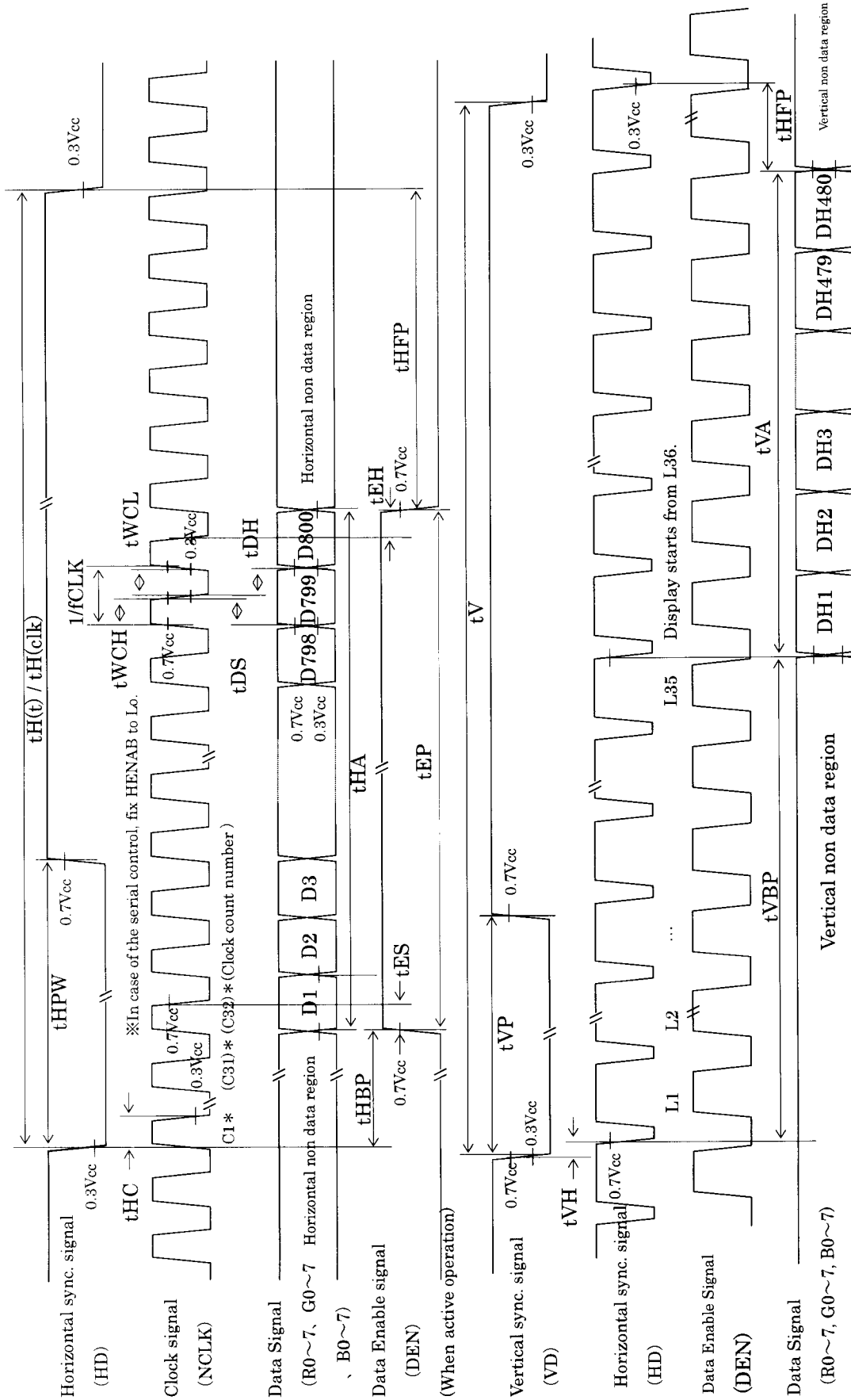

Fig. 2: Input signal timing chart

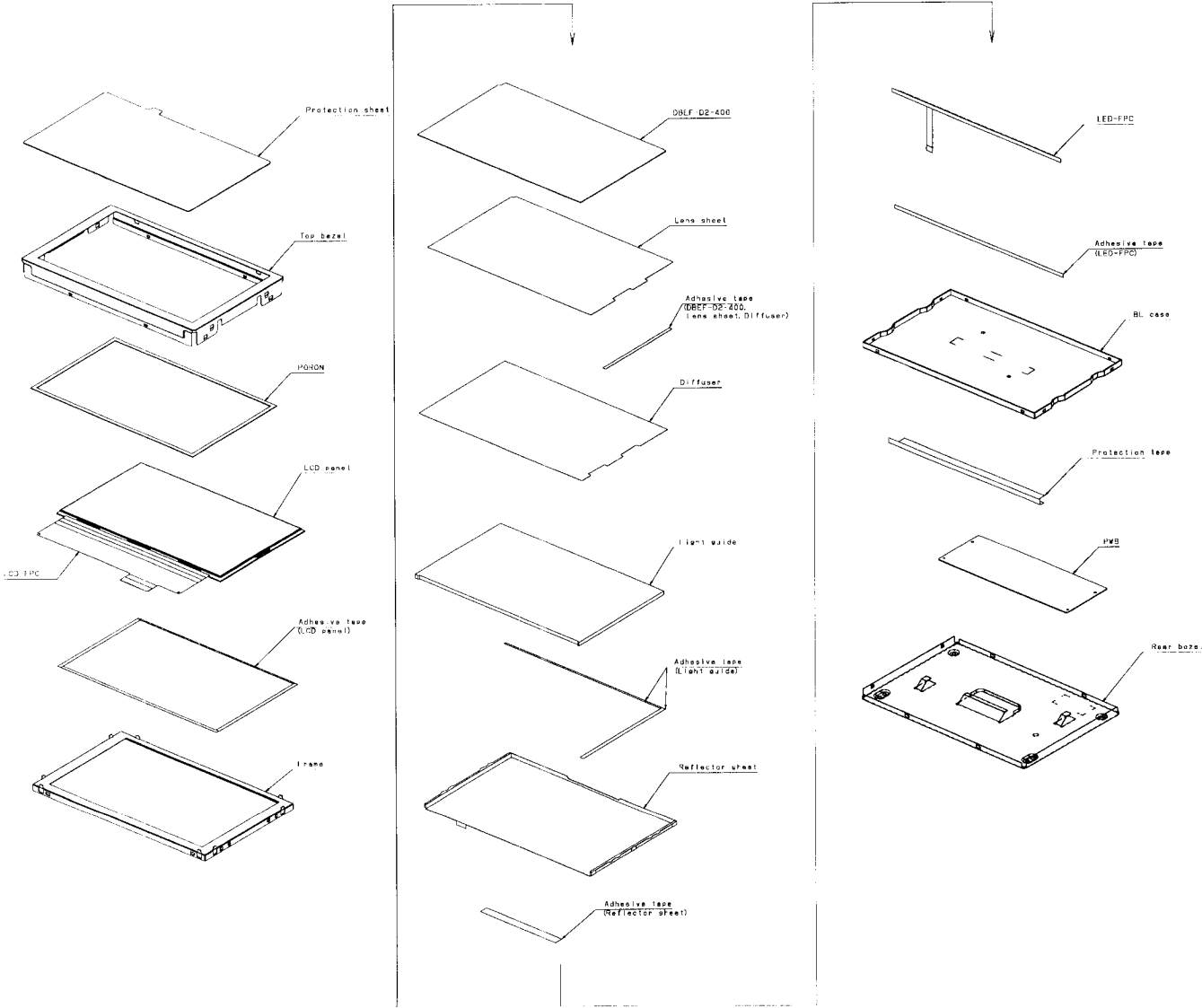
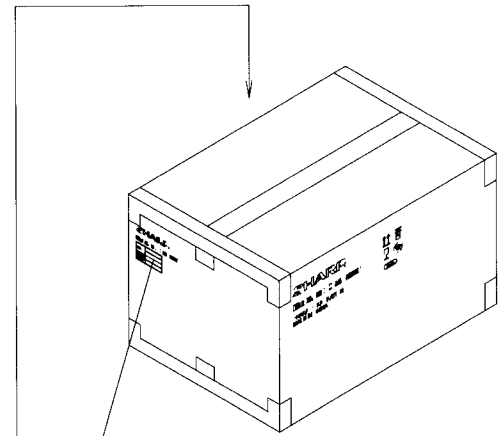
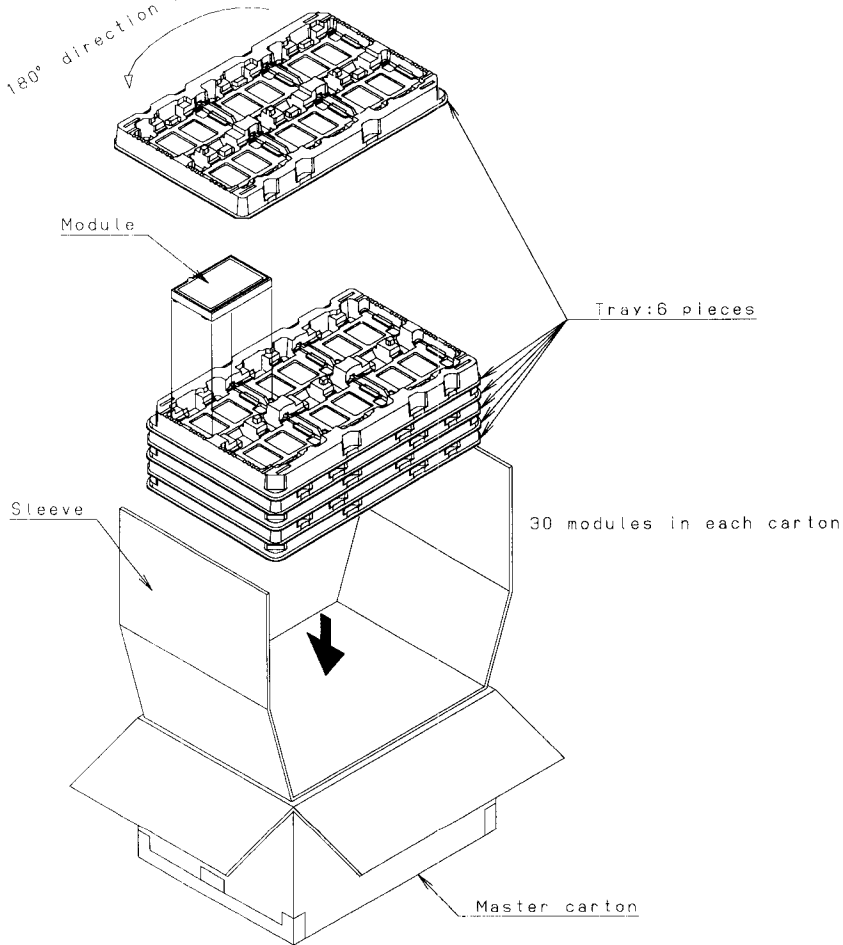

Fig.3 Exploded view of the device

180° direction is changed and piled.



Barcode label

社内品番 : (4S) LQ065Y5DZ01

LotNo. : (1T) ****. **.*

Quantity: 30 pcs

ユーザー品番 : ****

シャープ物流用ラベルです。 (****)

Fig. 1 Packing Form

LQ065Y5DZ01 Appendix A

LCY-10037B

LCD_Error Pin Information	
Functional Description	<ul style="list-style-type: none"> To check if source driver/gate driver start pulse signal returns in a specific time or not
Error judgment criteria (source driver)	<ul style="list-style-type: none"> After start pulse signal (STHL/STHR), the ASIC checks if the start pulse signal returns back within a specific period. If the ASIC does not receive the start pulse return within the given period, the ASIC will activate open drain FET.
Error judgment criteria (gate driver)	<ul style="list-style-type: none"> After start pulse signal (GSPOL/GSPIO), the ASIC checks if the start pulse signal returns back within a specific period. If the ASIC does not receive the start pulse return within the given period, the ASIC will activate open drain FET.
Error reset condition	<p>LCD_Error pin will go back to a non-error state if:</p> <ul style="list-style-type: none"> The ASIC receives both source/gate driver start pulse signals in the required time periods
How to attempt to reset	<ul style="list-style-type: none"> Follow module power down/up timing sequence as described in the specification OR Only toggle PON low per the timing requirements (while keeping other signals active), then assert PON high again.
When to start to monitor	<ul style="list-style-type: none"> 10 VSYNCs after Power Up sequence is complete
Interface Drawing	

BL_Error Pin Information	
Functional Description	<ul style="list-style-type: none"> To check output over voltage, open-LED, short-LED and over temperature.
Error judgment criteria	<ul style="list-style-type: none"> If the output voltage exceed the Vovp voltage set. (over voltage open-LED) If the returned voltage exceed the voltage set. (short-LED) If the temperature of LED driver over +165°C.
Error reset condition	<p>BL_Error pin will go back to a non-error state if:</p> <ul style="list-style-type: none"> the temperature of LED driver falls below +165°C. over voltage, open-LED and short-LED condition go back normally and cycling power or logging the PON
How to attempt to reset	<ul style="list-style-type: none"> Follow module power down/up timing sequence as described in the specification OR Only toggle PON low per the timing requirements (while keeping other signals active), then assert PON high again.
When to start to monitor	<ul style="list-style-type: none"> 10 VSYNCs after Power Up sequence is complete
Interface Drawing	