

PREPARED BY : DATE	<h1 style="font-size: 2em; margin: 0;">SHARP</h1> <p style="margin: 5px 0;">TENRI LIQUID CRYSTAL DISPLAY GROUP</p> <p style="margin: 5px 0;">SHARP CORPORATION</p> <h2 style="font-size: 1.5em; margin: 0;">SPECIFICATION</h2>	SPEC No. LD-8315
APPROVED BY : DATE		FILE No.
		ISSUE : Mar. 14, 1996
		PAGE : 15 pages
		APPLICABLE GROUP Tenri Liquid Crystal Display Group

DEVICE SPECIFICATION FOR

TFT-LCD Module

MODEL No.

LQ11S31

• CUSTOMER'S APPROVAL

BY. _____

PRESENTED

BY

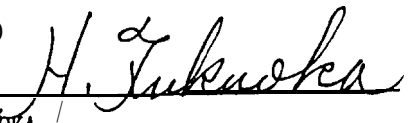

H. FUKUOKA

Department General Manager

Engineering Department 2

TFT LCD Development Center

TENRI LIQUID CRYSTAL DISPLAY GROUP

SHARP CORPORATION

These specification sheets are the proprietary product of SHARP CORPORATION("SHARP) and include materials protected under **copyright** of SHARP. Do not reproduce or cause **any** third party to reproduce them in any form or by any means, electronic or mechanical, for any purpose, in whole or in **part**, without the express written **permission** of SHARP.

The device listed in these specification sheets was designed and manufactured for use in OA equipment.

In case of using the device for applications such as control and safety equipment for **transportation(aircraft, trains, automobiles, etc.)**, rescue and security equipment and various safety related equipment which require higher reliability and safety, take into consideration that appropriate **measures** such as **fail-safe** functions and **redundant system design** should be taken.

Do not use the device for equipment that requires an extreme level of reliability, such as aerospace applications, telecommunication **equipment(trunk lines)**, nuclear power control equipment and medical or other equipment for life support.

SHARP assumes no responsibility for **any** damage **resulting** from the use of the device which does not comply with **the** instructions and the precautions specified in these specification sheets.

Contact and **consult** with a **SHARP** sales representative for any questions about this device.

1. Application

This specification applies to a color TFT-LCD module, LQ11 S31.

2. Overview

This **module** is a color active **matrix** LCD **module incorporating** amorphous silicon TFT (Thin Film Transistor). It is composed of a color **TFT-LCD** panel, driver ICs, control circuit and power supply circuit and a backlight tit. Graphics and texts can be displayed on a 800X3X 600 dots panel with 262,144 colors by supplying 18 bit data signals (6bit/color), four timing signals, +5.0V DC supply voltage for **TFT-LCD** panel driving and supply voltage for backlight.

The **TFT-LCD** panel used for this **module** has very high aperture ratio. A low-reflection and **higher**-color-saturation type color filter is also used for this panel. Therefore, high-brightness and **high**-contrast image, which is suitable for the multimedia use, can be obtained by using this module.

Optimum viewing direction is 6 o'clock

Backlight-driving DC/AC inverter is not built in this module.

[Features]

- 1) High aperture panel ; high-brightness or low power consumption.
- 2) **Brilliant and high** contrast image.
- 3) Small footprint and thin shape.
- 4) Light weight.

3. Mechanical Specifications

Parameter	Specifications	Unit
Display size	29 (11 ,3") Diagonal	cm
Active area	230.4 (H) × 172.8 (V)	mm
Pixel format	800 (H) X 600 (V)	pixel
	(1 pixel = R + G + B dots)	
Pixel pitch	0.288 (H) × 0.288 (V)	mm
Pixel configuration	R,G,B vertical stripe	
Display mode	Normally white	
Unit outline dimensions * 1	264.5 (W) × 193.5 (H) × 7.5 (D)	mm
Mass	430 ± 20	g
Surface treatment	Anti-glare and hard-coating 2H Low reflection (1.5%)	

*1, Note: excluding backlight cables.

Outline dimensions is shown in Fig. 1 (DRAWING No. : 2D-961-591)

4, Input Terminals

4-1 TFT-LCD panel driving

CN1: DF9MA-41P-1V (Hirose Electric Co., Ltd.)

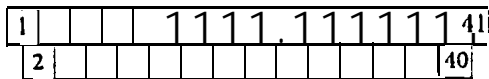

Mating connector: DF9□-41S-1V (#)

• # is A, B or M

CN1 pin arrangement from module surface
(Transparent view)

Pin No.	Symbol	Function	Remark
1	GND	-	
2	CK	Clock signal for sampling each data signal	
3	GND		
4	GND		
5	Hsync	Horizontal synchronous signal	【Note1】
6	Vsync	Vertical synchronous signal	【Note1】
7	GND		
8	R0	R E D data signal (LSB)	
9	RI	R E D data signal	
10	R2	R E D data signal	
11	R3	R E D data signal	
12	R4	R E D data signal	
13	R5	R E D data signal (MSB)	
14	GND		
15	GND		
16	GND		
17	G0	G R E E N data signal (LSB)	
18	G1	G R E E N data signal	
19	G2	G R E E N data signal	
20	G3	G R E E N data signal	
21	G4	G R E E N data signal	
22	G5	G R E E N data signal (MSB)	
23	GND		
24	GND	...	
25	GND		
26	B0	B L U E data signal (LSB)	
27	B1	B L U E data signal	
28	B2	B L U E data signal	
29	B3	B L U E data signal	
30	B4	B L U E data signal	
31	B5	B L U E data signal (MSB)	
32	GND		
33	GND		
34	GND		
35	ENAB	Signal to settle the horizontal display position	【Note2】
36	Vcc	+ 5.0V power supply	
37	Vcc	+ 5.0V power supply	
38	TST	This should be electrically opened during operation	
39	TST	This should be electrically opened during operation	
40	GND		
41	GND		

※The shielding case is connected with GND.

【Note1】 The polarity of both synchronous signals are negative.

【Note1】

On-off conditions for supply voltage

$0 < t1 \leq 10ms$

$0 < t2 \leq 50ms$

$0 < t3 \leq 1s$

$t4 > 1s$

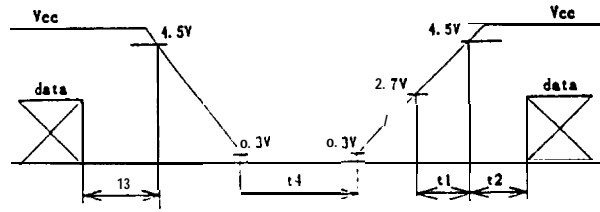

Vcc-dip conditions

1) $2.7V \leq Vcc < 4.5V$
 $td \leq 10ms$

2) $Vcc < 2.7V$

Vcc-dip conditions **should** also follow the on-off conditions

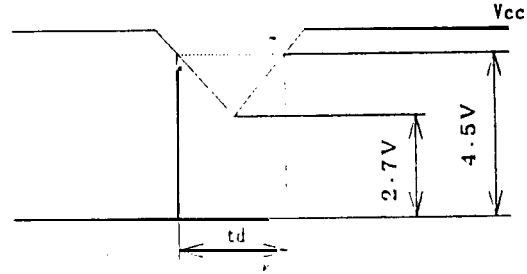

【Note2】 Typical current situation:

16-gray-bar pattern.

$Vcc=5.0V$

【Note3】 CK,R0~R5,G0~G5,B0~B5, Hsync,Vsync,ENAB

【Note4】 CK,R0~R5,G0~G5, B0~B5,Hsync,Vsync

【Note5】 ENAB

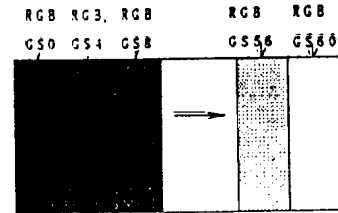

6-2, Backlight driving

The backlight system is an **edge-lighting** type with single CCFT (Cold Cathode Fluorescent Tube). The characteristics of the lamp are shown in the following table.

Parameter	Symbol	Min.	TYP.	Max.	unit	Remark
Lamp current range	IL	1.5	2.4	6.0	mArms	【Note1】
Lamp power consumption	PL	-	1.4	-	W	$Y_L = 70cd/m^2$
Lamp frequency	FL	20	35	60	KHz	【Note2】
Kick-off voltage	Vs	-	-	1100	Vrms	$Ta=25^{\circ}C$
		-	-	1300	Vrms	$Ta=0^{\circ}C$ 【Note3】
Lamp life time	LL	10000	-	-	hour	【Note4】

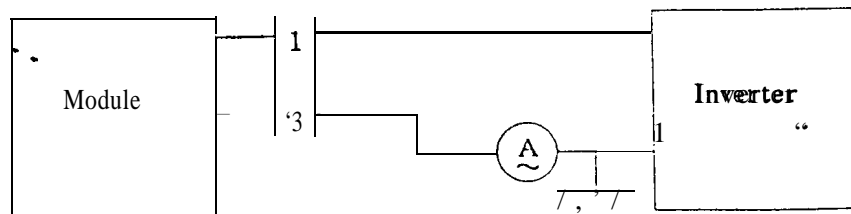

*3pin is V_{LOW}

【Note1】 Lamp current is measured with current meter for high frequency as shown below.

【Note2】 Lamp frequency may produce interference with horizontal synchronous frequency, and this may cause beat on the display. Therefore lamp frequency shall be detached as much as possible from the horizontal synchronous frequency and from the harmonics of horizontal synchronous to avoid interference.

【Note3】 The voltage above this value should be applied to the lamp for more than 1 second to startup. Otherwise the lamp may not be turned on.

【Note4】 Lamp life time is defined as the time when either ① or ② occurs in the continuous operation under the condition of $T_a=25^{\circ}\text{C}$ and $I_L=6.0\text{ mA rms}$.

① Brightness becomes 50% of the original value under standard condition.

② Kick-off voltage at $T_a=0^{\circ}\text{C}$ exceeds maximum value, 1300 Vrms.

Note) The performance of the backlight, for example life time or brightness, is much influenced by the characteristics of the DC-AC inverter for the lamp, When you design or order the inverter, please make sure that a poor lighting caused by the mismatch of the backlight and the inverter (miss-lighting, flicker, etc.) never occur. When you confirm it, the module should be operated in the same condition as it is installed in your instrument.

7. Timing characteristics of input signals

Timing diagrams of input signal are shown in Fig.2.

7-1. Timing characteristics

Parameter		Symbol	Min.	Typ.	Max.	unit	Remark
Clock	Frequency	In-c	—	40.0	42.0	MHz	
	High time	Tch	5	—	—	ns	
	Low time	Tcl	5	—	—	ns	
	Duty ratio	TH/T	40	50	60	%	
Data	Setup time	Tds	3	—	—	ns	
	Hold time	Tdh	10	—	—	ns	
Horizontal sync. Signal	Cycle	TH	20.8	26.4	—	μs	
			832	1056	—	clock	
	Pulse width	THp	2	128	200	clock	
Vertical sync. Signal	Cycle	TV	628	666	798	line	
	Pulse width	TVp	1	4	6	line	
Horizontal display period		THd	800	800	800	clock	
Hsync-Clock phase difference		THc	10	—	Tc-10	ns	
Vertical data start position		TVs	23	23	23	line	See 7.3
Hsync-Vsync phase difference		TVh	0	—	TH-THp	clock	

Note) In case of lower frequency, the deterioration of display quality, flicker etc. may be occurred.

7-2. Horizontal display position

The horizontal display position is determined by ENAB signal and the input data corresponding to the rising edge of ENAB signal is displayed at the **left** end of the active area.

Parameter		Symbol	Min.	Typ.	Max.	Unit	Remark
Enable signal	Setup time	Tes	5	—	Tc-10	ns	
	Pulse width	Tep	2	800	Th-10	clock	
Hsync-Enable signal phase difference		THE	58	88	170	clock	

Note) When ENAB is fixed “Low”, the display starts from the data of C88(clock) as shown in Fig.2.

Be **careful** that the module does@ work when ENAB is fixed “High”.

7-3. Vertical display position

The vertical display position, Tvs, is fixed “23” (line).

7-4. hput Data Signals and Display Position on the screen

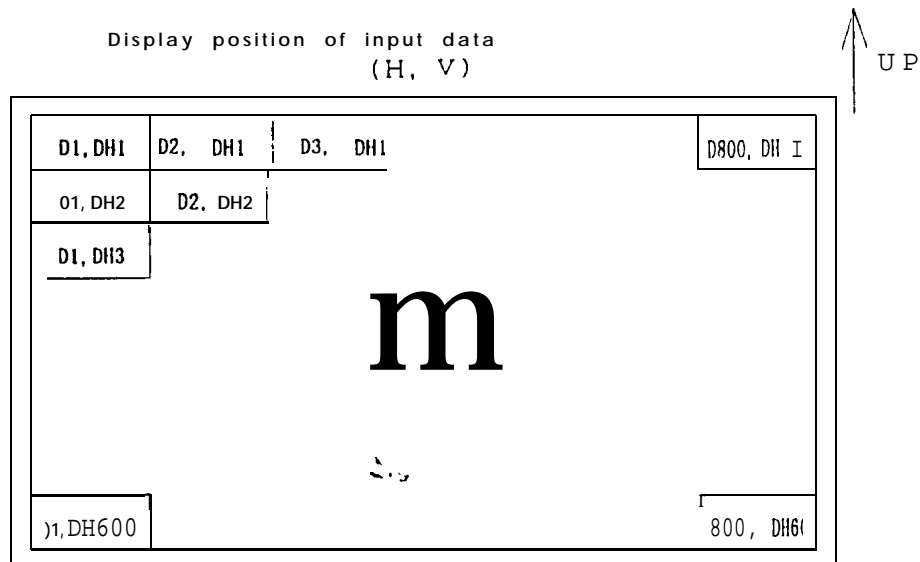

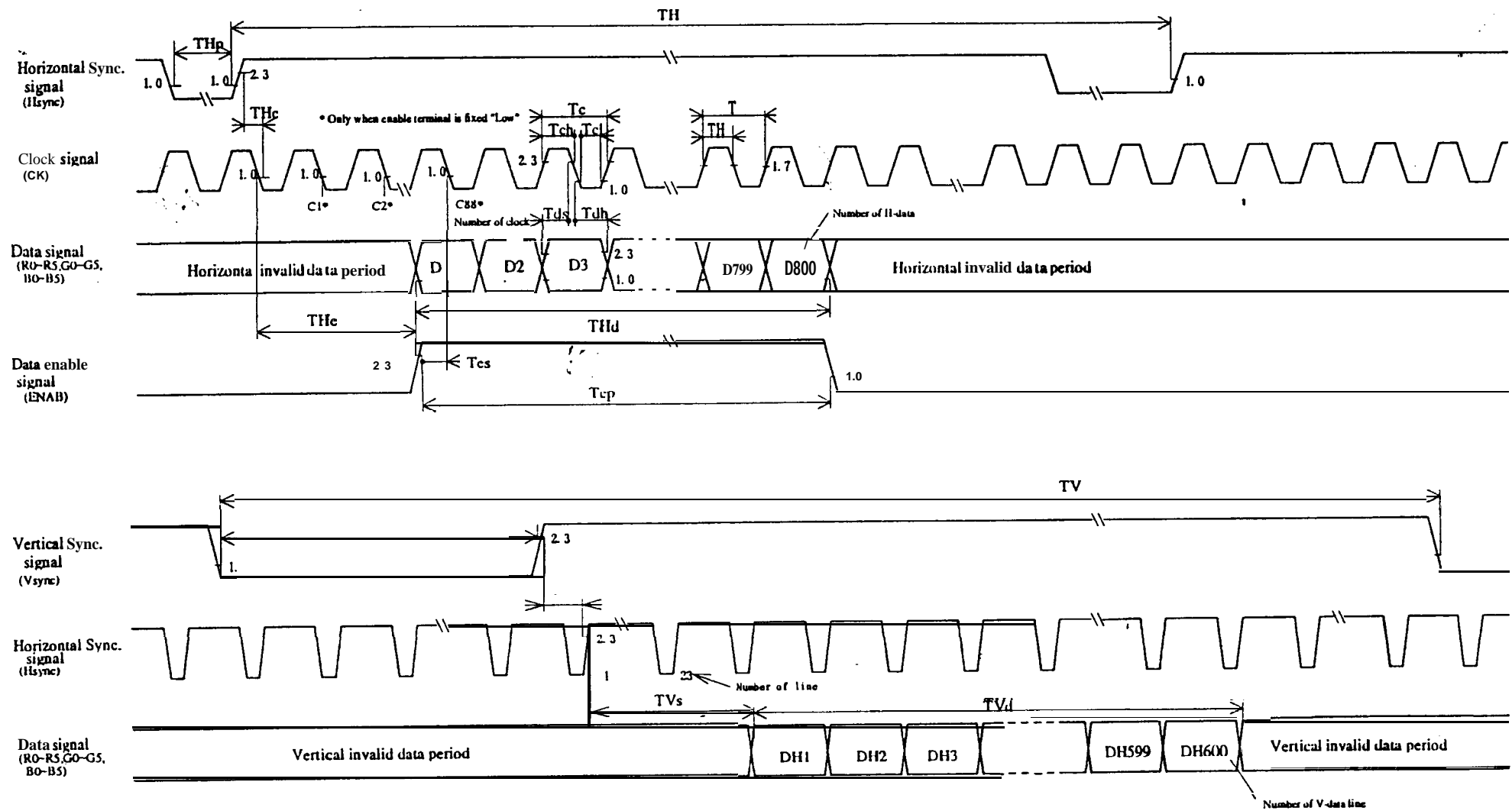

, Fig.2 Input signal waveform

8. Input Signals, Basic Display Colors and Gray Scale of Each Color

Colors & Gray scale	Data signal																			
	GrayScale	RO	R1	R2	R3	R4	R5	G0	G1	G2	G3	G4	G5	B0	B1	B2	B3	B4	B5	
Basic Color	Black	-	0	0	0	0	0	0	0	0	0	0	0	0	0	0	0	0	0	0
	Blue	-	0	0	0	0	0	0	0	0	0	0	0	0	1	1	1	1	1	1
	Green	-	0	0	0	0	0	0	1	1	1	1	1	1	0	0	0	0	0	0
	Cyan	-	0	0	0	0	0	0	1	1	1	1	1	1	1	1	1	1	1	1
	Red	-	1	1	1	1	1	1	0	0	0	0	0	0	0	0	0	0	0	0
	Magenta	-	1	1	1	1	1	1	0	0	0	0	0	0	1	1	1	1	1	1
	Yellow	-	1	1	1	1	1	1	1	1	1	1	1	1	0	0	0	0	0	0
	White	-	1	1	1	1	1	1	1	1	1	1	1	1	1	1	1	1	1	1
Gray Scale of Red	Black	GS0	0	0	0	0	0	0	0	0	0	0	0	0	0	0	0	0	0	0
	↑	GS1	1	0	0	0	0	0	0	0	0	0	0	0	0	0	0	0	0	0
	Darker	GS2	0	1	0	0	0	0	0	0	0	0	0	0	0	0	0	0	0	0
	↑	↓				↓					↓					↓				
	↓	↓				↓					↓					↓				
	Brighter	GS61	1	0	1	1	1	1	0	0	0	0	0	0	0	0	0	0	0	0
	↓	GS62	0	1	1	1	1	1	0	0	0	0	0	0	0	0	0	0	0	0
Red	GS63	1	1	1	1	1	1	0	0	0	0	0	0	0	0	0	0	0	0	
Gray Scale of Green	Black	GS0	0	0	0	0	0	0	0	0	0	0	0	0	0	0	0	0	0	0
	↑	GS1	0	0	0	0	0	0	1	0	0	0	0	0	0	0	0	0	0	0
	Darker	GS2	0	0	0	0	0	0	0	1	0	0	0	0	0	0	0	0	0	0
	↑	↓				↓					↓					↓				
	↓	↓				↓					↓					↓				
	Brighter	GS61	0	0	0	0	0	0	1	0	1	1	1	1	0	0	0	0	0	0
	↓	GS62	0	0	0	0	0	0	0	1	1	1	1	1	0	0	0	0	0	0
Green	GS63	0	0	0	0	0	0	1	1	1	1	1	1	0	0	0	0	0	0	
Gray Scale of Blue	Black	GS0	0	0	0	0	0	0	0	0	0	0	0	0	0	0	0	0	0	0
	↑	GS1	0	0	0	0	0	0	0	0	0	0	0	0	1	0	0	0	0	0
	Darker	GS2	0	0	0	0	0	0	0	0	0	0	0	0	0	1	0	0	0	0
	↑	↓				↓					↓					↓				
	↓	↓				↓					↓					↓				
	Brighter	GS61	0	0	0	0	0	0	0	0	0	0	0	0	1	0	1	1	1	1
	↓	GS62	0	0	0	0	0	0	0	0	0	0	0	0	0	1	1	1	1	1
Blue	GS63	0	0	0	0	0	0	0	0	0	0	0	0	1	1	1	1	1	1	

0 :Low level voltage, 1: High level voltage

Each basic color can be displayed in 64 gray scales from 6 bit data signals. According to the combination of total 18 bit data signals, the 262,144-color display can be achieved on the screen.

9. Optical Characteristics

Ta=25°C, Vcc=+5.0V

Parameter	Symbol	Condition	Min.	Typ.	Max.	unit	Remark	
Viewing angle range	Horizontal	621,022	CR>10	45	—	—	Deg.	【Note1,4】
	Vertical	$\theta 11$		10	—	—	Deg.	
		$\theta 12$		30	—	—	Deg.	
Contrast ratio	C Rn	$\theta = 0'$	150	—	—		【Note2,4】	
	C Ro	Optimum viewing angle	—	300	—			
Response time	Rise	τr	$e = 0^\circ$	—	30	—	m s	【Note3,4】
	Decay	τd		—	50	—	m s	
Chromaticity of white	x		0.263	0.313	0.363		【Note4】	
	y		0.279	0.329	0.379			
Luminance of white 【Note4】	Y_{L1}		50	70	—	cd/m ²	$I_L = 2.4 \text{ mArms}$	
	Y_{L2}		—	180	—	cd/m ²	$I_L = 6.0 \text{ mArms}$	
White Uniformity	δ_w		—	—	1.45		【Note5】	

※ The measurement shall be executed 30 minutes after lighting at rating.

(typical condition: $I_L = 2.4 \text{ inks}$)

The optical characteristics shall be measured in a dark room or equivalent state with the method shown in Fig.3 below.

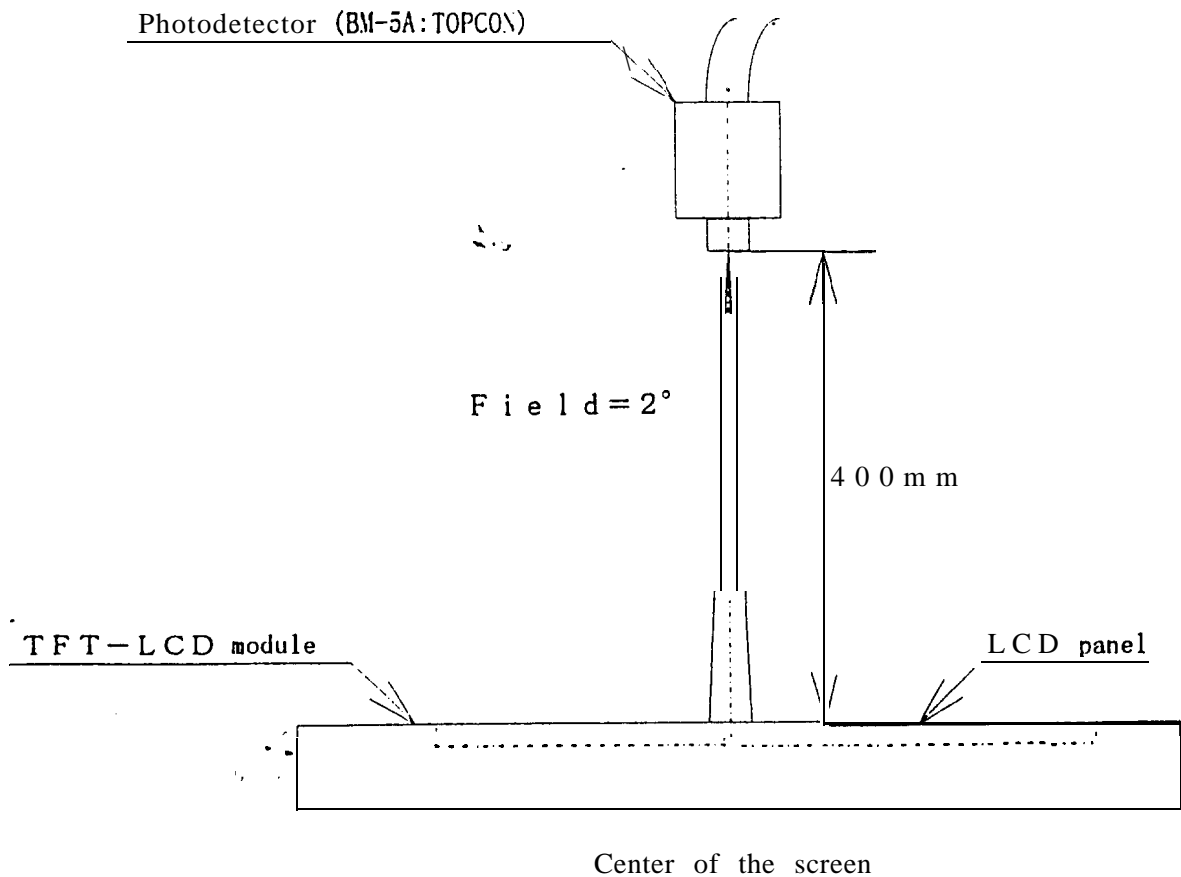
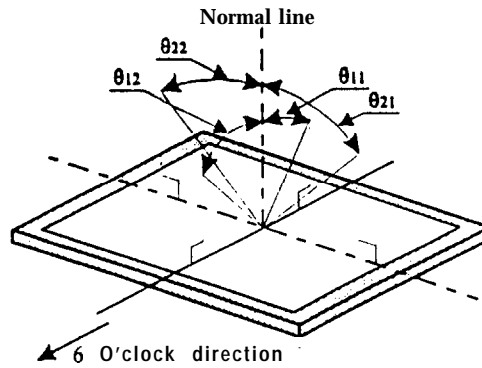

Fig. 3 Optical characteristics measurement method

[Note1] Definitions of viewing angle range:



[Note2] Definition of **contrast** ratio:

The contrast ratio is defined as the following.

$$\text{Contrast Ratio (CR)} = \frac{\text{Luminance (brightness) with all pixels white}}{\text{Luminance (brightness) with all pixels black}}$$

[Note3] Definition of response time:

The response time is defined as the following figure and shall be measured by switching the input signal for “black” and “white”

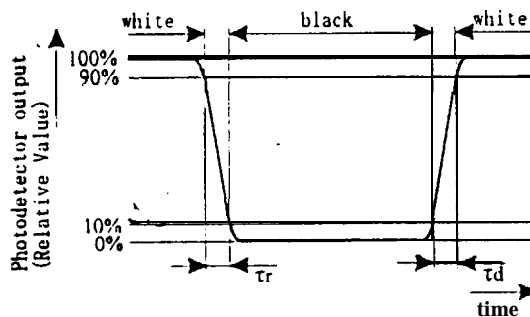

[Note4] This shall be measured at center of the screen.

[Note5] Definition of white uniformity:

White uniformity is **defined** as the following with five measurements (A~E).

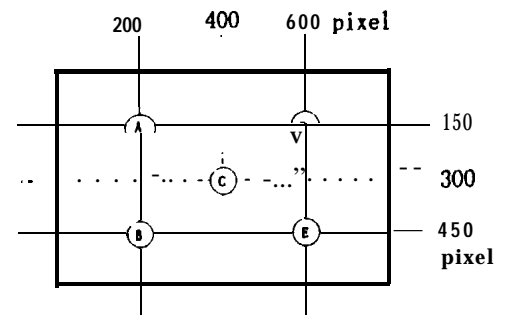

$$\delta_w = \frac{\text{Maximum Luminance of five points (brightness)}}{\text{Minimum Luminance of five points (brightness)}}$$

10, Display Quality

The display quality of the color TFT-LCD module shall be in compliance with the Incoming Inspection Standard.

11. Handling Precautions

- a) Be sure to turn off the power supply when inserting or disconnecting the cable.
- b) Be sure to design the cabinet so that the module can be installed without any extra stress such as warp or twist.
- c) Since the front polarizer is easily damaged, pay attention not to scratch it.
- d) Wipe off water drop immediately. Long contact with water may cause discoloration or spots.
- e) When the panel surface is soiled, wipe it with absorbent cotton or other soft cloth.
- f) Since the panel is made of glass, it may break or crack if dropped or bumped on hard surface. Handle with care.
- g) Since CMOS LSI is used in this module, take care of static electricity and injure the human earth when handling.
- h) Observe all other precautionary requirements in handling components.
- i) This module has its circuitry PCBs on the rear side and should be handled carefully in order not to be stressed.
- j) Laminated film is attached to the module surface to prevent it from being scratched. Peel the film off slowly just before the use with strict attention to electrostatic charges. Ionized air shall be blown over during the action. Blow off the 'dust' on the polarizer by using an ionized nitrogen gun, etc..
- k) Black PET sheet covers some electric components and handle with special care to avoid mechanical stress and shock on this PET surface.

12. Packing form

- a) Piling number of cartons : **MAX.7**
- b) Package quantity in one carton : 10pts
- c) Carton size : 310(~ × 350(H) × 350(D)mm
- d) Total mass of one carton filled with full modules : 6000g

Packing form is shown in **Fig.4**

13. Reliability test items

No.	Test item	Conditions
1	High temperature storage test	Ta=60°C 240h
2	Low temperature storage test	Ta=-25°C 240h
3	High temperature & high humidity operation test	Ta=40°C ; 95%RH 240h (No condensation)
4	High temperature operation test	Ta=50°C 240h (The panel temp must be less than 60°C)
5	Low temperature operation test	Ta=0°C 240H
6	Vibration test (non- operating)	Frequency : 10~57Hz/Vibration width (one side) :0.075mm : 58500 Hz/Gravity :9.8m/s ² Sweep time :11 minutes Test period :3 hours “ (1 hour for each direction of X,Y,Z)
7	Shock test (non- operating)	Max. gravity: 490m/s ² Pulse width :11 ms, sine wave Direction : ±X, ±Y, ±Z once for each direction.

14. Others

1) Lot No.Label

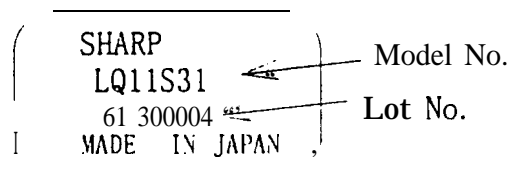

- 2) Adjusting volume have been set optimally before shipment, so do not change any adjusted value.
If adjusted value is changed, the specification may not be satisfied.
- 3) Disassembling the module can cause permanent damage and should be strictly avoided.
- 4) Please be careful since image retention may occur when a fixed pattern is displayed for-a long time.
- 5) If any problem occurs in relation to the description of this specification, it shall be resolved through discussion with spirit of cooperation.

- NOTES
1. UNSPECIFIED TOLERANCE TO BE ± 0.5
 2. WARP AND FLATING FOR PCB AND CHASSIS ARE EXCLUDED FROM THICKNESS AND DIMENSION OF THE UNIT
 3. ELECTRONIC PARTS ARE ARRANGED UNDER COVER. (HATCHING AREA) PLEASE DO NOT PRESS.

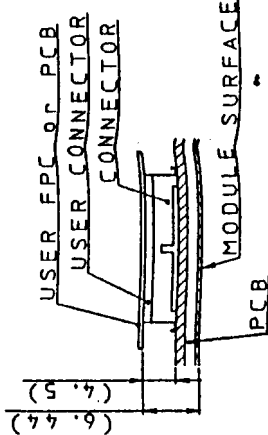
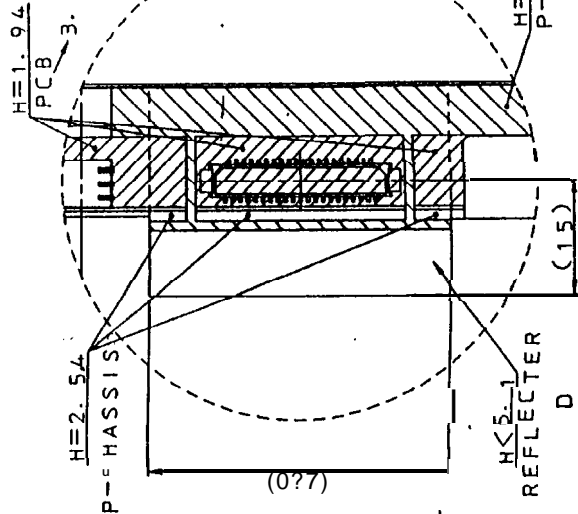
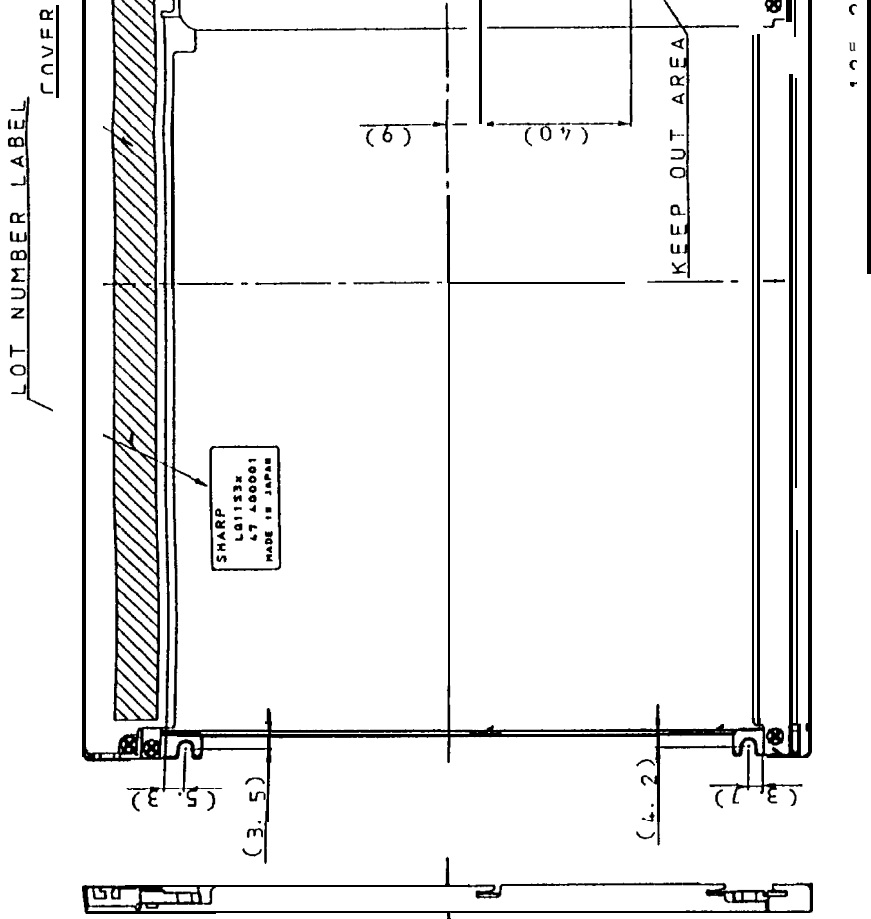
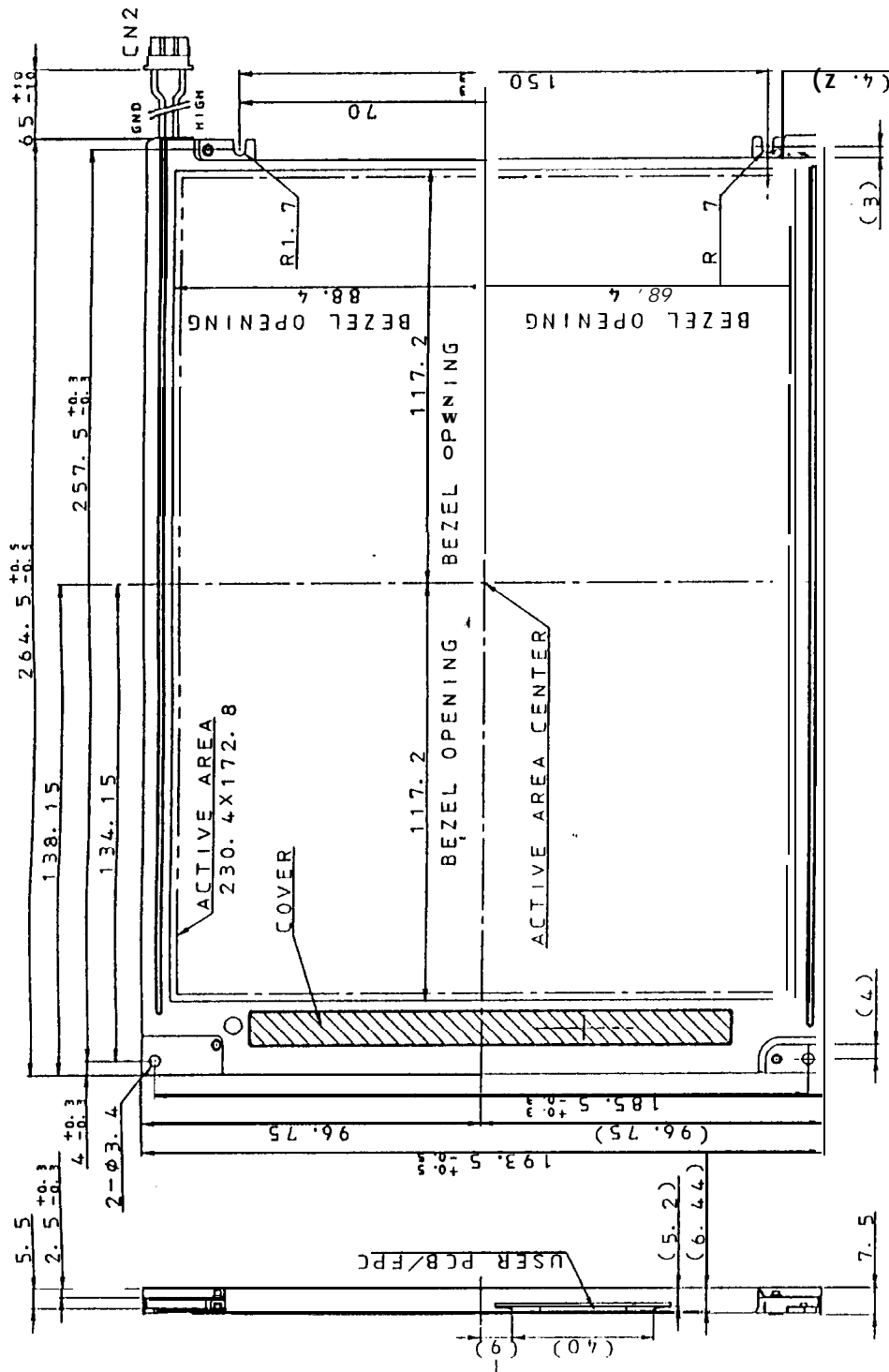
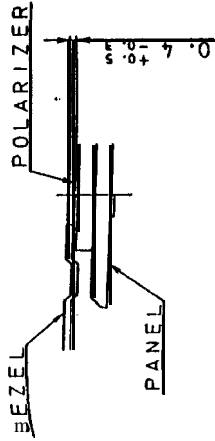

CCFT CONNECTOR
CN2: BHR-03VS-1 (JST)
PIN LAYOUT

1	HIGH
2	NC
3	GND

INTERFACE CONNECTOR
CN: DF9MA-41P-1V (H: ROSE)
PIN LAYOUT (41PINS)

BIN	1	2	3	4	5	6	7	8	9	10	11	12	13	14	15
GND	CK	GND	GND	MSync	VSync	GND	RD	R1	R2	R3	R4	R5	GND	GND	GND
16	17	18	19	20	21	22	23	24	25	26	27	28	29	30	31
GND	G0	G1	G2	G3	G4	G5	GND	GND	GND	R0	R1	R2	R3	R4	R5
32	33	34	35	36	37	38	39	40	41						
GND	GND	EMAB	VCC	TST	TST	GND	GND	GND	GND						

1) TOLERANCE X-DIRECTION A: ± 0.8
2) TOLERANCE Y-DIRECTION B: ± 0.8
3) OBLIQUITY OF DISPLAY AREA IC-0

DETAIL KEEP OUT AREA

Fig1. OUTLINE DIMENSIONS