

LQ121S1LG41

TFT-LCD Module

(Model No.: LQ121S1LG41)

Spec No.: LD-15606
Issue Date: June 20, 2003

PREPARED BY : DATE	 AVC LIQUID CRYSTAL DISPLAY GROUP SHARP CORPORATION SPECIFICATION	SPEC No. LD-15606
APPROVED BY : DATE		FILE No.
		ISSUE : JUN. 20. 2003
		PAGE : 16 pages
		APPLICABLE GROUP AVC LIQUID CRYSTAL DISPLAY GROUP

DEVICE SPECIFICATION FOR
TFT-LCD Module
MODEL No.
LQ121S1LG41

CUSTOMER'S APPROVAL

DATE _____

BY _____

PRESENTED

BY *Makoto Takeda*

M. TAKEDA
Department General Manager
Development Engineering Department II
AVC LIQUID CRYSTAL DISPLAY Division
AVC LIQUID CRYSTAL DISPLAY GROUP
SHARP CORPORATION

These specification sheets are the proprietary product of SHARP CORPORATION ("SHARP") and include materials protected under copyright of SHARP. Do not reproduce or cause any third party to reproduce them in any form or by any means, electronic or mechanical, for any purpose, in whole or in part, without the express written permission of SHARP.

The device listed in these specification sheets was designed and manufactured for use in general electronic equipment.

In case of using the device for applications such as control and safety equipment for transportation (aircraft, trains, automobiles, etc.), rescue and security equipment and various safety related equipment which require higher reliability and safety, take into consideration that appropriate measures such as fail-safe functions and redundant system design should be taken.

Do not use the device for equipment that requires an extreme level of reliability, such as aerospace applications, telecommunication equipment (trunk lines), nuclear power control equipment and medical or other equipment for life support.

SHARP assumes no responsibility for any damage resulting from the use of the device which does not comply with the instructions and the precautions specified in these specification sheets.

Contact and consult with a SHARP sales representative for any questions about this device.

1. Application

This specification applies to a color TFT-LCD module, LQ121S1LG41.

2. Overview

This module is a color active matrix LCD module incorporating amorphous silicon TFT (Thin Film Transistor). It is composed of a color TFT-LCD panel, driver ICs, control circuit and power supply circuit and a backlight unit. Graphics and texts can be displayed on a 800 X 3 X 600 dots panel with 262,144 colors by using LVDS (Low Voltage Differential Signaling) system for interface and supplying +3.3V +5.0V DC supply voltage for TFT-LCD panel driving and supply voltage for backlight.

The TFT-LCD panel used for this module is a low-reflection and higher-color-saturation type.

Therefore, this module is also suitable for the multimedia use. Viewing angle is 6 o'clock direction.

This module is the type of wide viewing angle and high brightness(370cd/m2).

Backlight-driving DC/AC inverter is not built in this module.

3. Mechanical Specifications

Parameter	Specifications	Unit
Display size	31 (12.1") Diagonal	cm
Active area	246.0 (H) X 184.5 (V)	mm
Pixel format	800 (H) X 600 (V)	pixel
	(1 pixel=R+G+B dots)	
Pixel pitch	0.3075 (H) X 0.3075 (V)	mm
Pixel configuration	R,G,B vertical stripe	
Display mode	Normally white	
Unit outline dimensions *1	276.0(W)×209.0(H)×Max.11.0 (D)	mm
Mass	MAX. 660	g
Surface treatment	Anti-glare and hard-coating 3H	

*1.Note: excluding backlight cables.

Outline dimensions is shown in Fig.1

4. Input Terminals

4-1. TFT-LCD panel driving

CN1 (LVDS signals and +3.3V / +5.0V DC power supply)

Corresponding connector:FI-SE20M (JAE) or FI-S20S (JAE)

Pin No.	Symbol	Function	Remark
1	V _{CC}	+3.3V / +5.0V power supply	
2	V _{CC}	+3.3V / +5.0V power supply	
3	GND		
4	GND		
5	RXIN0-	Differential data input, CH0 (negative)	LVDS
6	RXIN0+	Differential data input, CH0 (positive)	LVDS
7	GND		
8	RXIN1-	Differential data input, CH1 (negative)	LVDS
9	RXIN1+	Differential data input, CH1 (positive)	LVDS
10	GND		
11	RXIN2-	Differential data input, CH2 (negative)	LVDS
12	RXIN2+	Differential data input, CH2 (positive)	LVDS
13	GND		
14	RXCLK IN-	Differential clock input (negative)	LVDS
15	RXCLK IN+	Differential clock input (positive)	LVDS
16	GND		
17	R/L	Horizontal display mode select signal	[Note3]
18	U/D	Vertical display mode select signal	[Note4]
19	GND		
20	GND		

[Note 1] To obtain the proper relation between LVDS signals and actual digital data signals, the digital signals should be inputted into the transmitter as described in the next section, 4-2.

[Note 2] The shielding case is connected with signal GND.

[Note 3],[Note 4]

R/L = High, U/D = Low

R/L = Low, U/D = Low

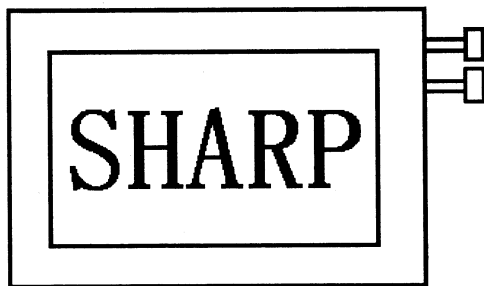

R/L = High, U/D = High

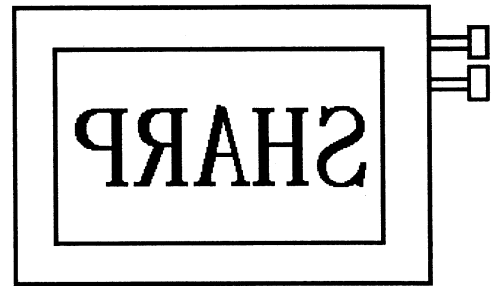

R/L = Low, U/D = High

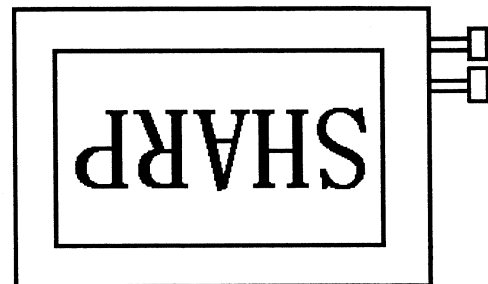
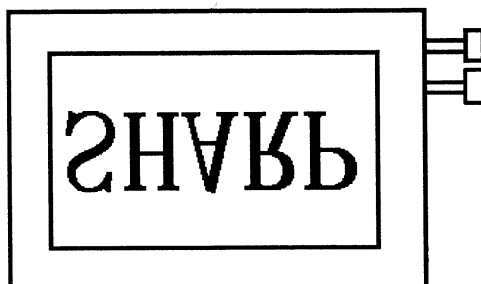

4-2 Interface block diagram

Using receiver: Single LVDS interface, which equals THC63LVDF64A (THine), contained in a control IC
 Corresponding Transmitter: DS90C363, DS90C383, DS90C363A, DS90C383A, DS90CF563, DS90CF583 (National semiconductor),
 THC63LVDM63R, THC63LVDM83R (THine), SN75LVDS84 (Ti)

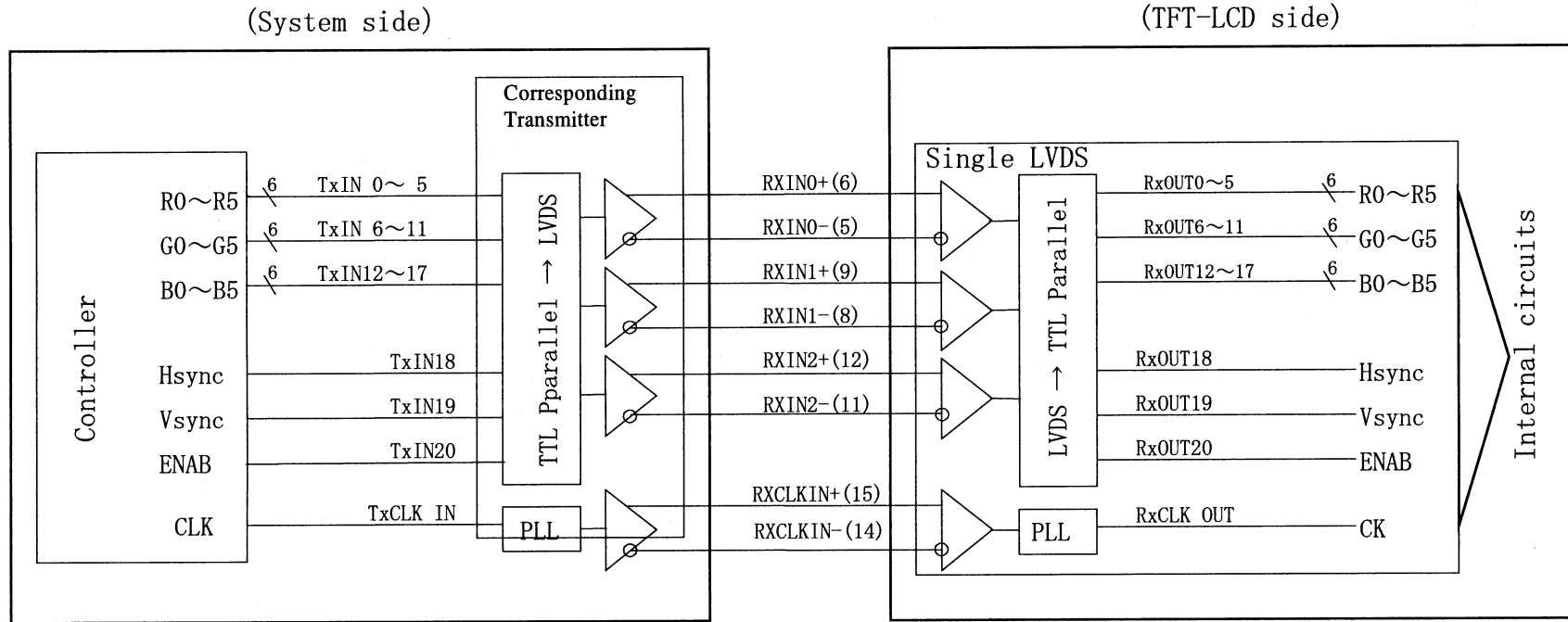

4-2. Backlight driving CN2 ,CN3

Used connector : BHR-03VS-1(JST)

Corresponding connector :SM02(8.0)B-BHS(JST)

Pin no.	symbol	function
1	VHIGH	Power supply for lamp (High voltage side)
2	NC	This is electrically opened.
3	VLOW	Power supply for lamp (Low voltage side)

5. Absolute Maximum Ratings

Parameter	Symbol	Condition	Pin name	Ratings	Unit	Remark
+3.3V / +5.0V supply voltage	Vcc	Ta=25°C	Vcc	0 to + 6.0	V	
Input voltage	VI1	Ta=25°C	RXINi(i= 0,1,2)	-0.3 to Vcc+0.3	V	VCC<3.0V
				-0.3 to 3.3V	V	3.0V ≤ VCC
	VI2	Ta=25°C	R/L , U/D	-0.3 to Vcc+0.3	V	
Storage temperature	Tstg	-	-	-30 to +70	°C	[Note1]
Operating temperature	Topa	Ambient	-	-10 to +65	°C	

[Note1] Humidity: 95%RH Max. at Ta=<40°C.

Maximum wet-bulb temperature at 39°C or less at Ta>40°C.

No condensation.

6. Electrical Characteristics

6-1.TFT-LCD panel driving

Ta=25°C

Parameter		Symbol	Min.	Typ.	Max.	Unit	Remark
Power Supply	Supply voltage	Vcc	+3.0	+3.3/ +5.0V	+5.5	V	[Note2]
	Current dissipation	Icc	-	430	530	mA	[Note3]Vcc=+3.3V
		Icc	-	260	310		[Note3]Vcc=+5.0V
Permissible input ripple voltage		VRP	-	-	100	mVp-p	Vcc=+5.0V
Input voltage range		LVDS	VL	0	2.4	V	[Note4]
Input voltage (Low)		signal	VIL	-	0.8	V	[Note5] [Note6]
Input voltage (High)			VIH	2.1	-		
Differential input threshold voltage	High	VTH	-	-	VCM+ 100	mV	VCM=1.2V [Note1]
	Low	VTL	VCM- 100	-	-	mV	
Input impedance		RT	-	100	-	Ω	Differential input [Note4]
Input current (low)		IOL1	-800	-	-	uA	VI=0V [Note5]
		IOL2	-10.0	-	10.0		VI=0V [Note6]
Input current (High)		IOH1	-10.0	-	10.0	uA	VI=2.4V [Note5]
		IOH2	-	-	800		VI=VCC [Note6]

[Note1] V_{CM} : Common mode voltage of LVDS driver.

[Note2]

On-off conditions for supply voltage

- $0 < t_1 \leq 15\text{ms}$
- $0 < t_2 \leq 10\text{ms}$
- $0 < t_3 \leq 100\text{ms}$
- $0 < t_4 \leq 1\text{s}$

$200\text{ms} < t_5$

Vcc-dip conditions

- 1) $2.5\text{V} \leq V_{cc}$
 $t_d \leq 10\text{ms}$
- 2) $V_{cc} < 2.5\text{V}$

Vcc-dip conditions should also follow the On-off conditions for supply voltage

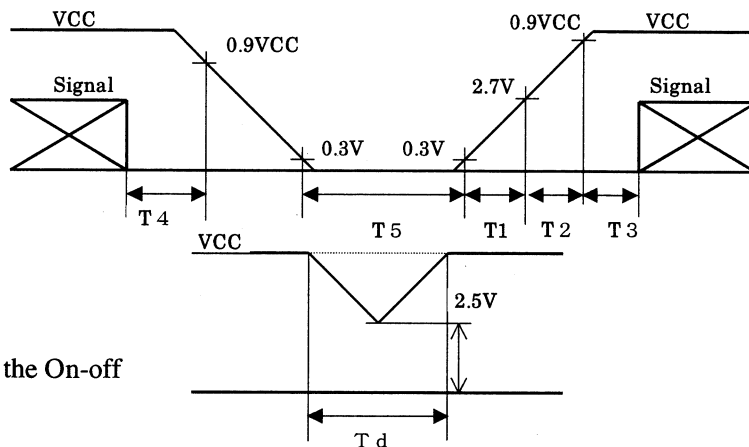

[Note3] Typical current situation : 16-gray-bar pattern.

$V_{cc} = +3.3\text{V} / +5.0\text{V}$

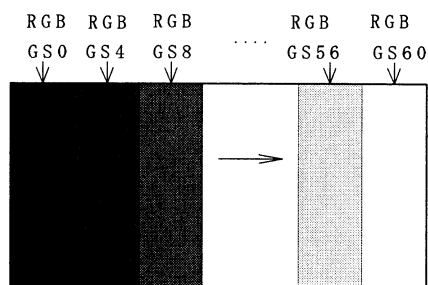

[Note4] LVDS signals

[Note5] R/L

[Note6] U/D

6-2. Backlight driving

The backlight system is an edge-lighting type with single CCFT (Cold Cathode Fluorescent Tube). The characteristics of the lamp are shown in the following table.

Parameter	Symbol	Min.	Typ.	Max.	Unit	Remark
Lamp current range	IL	3.0	6.0	6.5	mArms	[Note1]
Lamp power consumption	PL	-	3.5	-	W	[Note2]
Lamp frequency	FL	40	60	80	kHz	[Note3]
Kick-off voltage	Vs	-	-	1200	Vrms	Ta=25 °C
		-	-	1400		Ta=0 °C
		-	-	1500		Ta=-10 °C
Lamp life time	LL	50000	-	-	hour	[Note5]

[Note1] Lamp current is measured with current meter for high frequency as shown below.

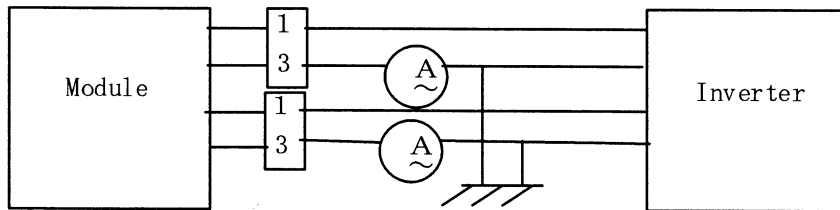

* 3pin is V_{LOW}

[Note2] At the condition of $I_L=6.0\text{mA}_{\text{rms}}$

[Note3] Lamp frequency may produce interference with horizontal synchronous frequency, and this may cause beat on the display. Therefore lamp frequency shall be detached as much as possible from the horizontal synchronous frequency and from the harmonics of horizontal synchronous to avoid interference.

[Note4] The voltage above this value should be applied to the lamp for more than 1 second to start-up. Otherwise the lamp may not be turned on.

[Note5] Since lamp is consumables, the life time written above is referencial value and it is not guaranteed in this specification sheet by SHARP.

Lamp life time is defined that it applied either ① or ② under this condition
(Continuous turning on at $T_a=25^\circ\text{C}$, $I_L=6.0\text{mA}_{\text{rms}}$)

① Brightness becomes 50% of the original value under standard condition.

② Kick-off voltage at $T_a=-10^\circ\text{C}$ exceeds maximum value, $1500\text{V}_{\text{rms}}$.

In case of operating under lower temp environment, the lamp exhaustion is accelerated and the brightness becomes lower. (Continuous operating under for around 1 month under lower temp condition may reduce the brightness to half of the original brightness.)

In case of such usage under lower temp environment, periodical lamp exchange is recommended.

[Note6] The performance of the backlight, for example life time or brightness, is much influenced by the characteristics of the DC-AC inverter for the lamp. When you design or order the inverter, please make sure that a poor lighting caused by the mismatch of the backlight and the inverter (miss-lighting, flicker, etc.) never occur. When you confirm it, the module should be operated in the same condition as it is installed in your instrument.

Be sure to use a back light power supply with the safety protection circuit such as the detection circuit for the excess voltage, excess current and or electric discharge waveform.

Be sure to use the detect circuit by which one side of the CCFT lamps can be controlled independently. Otherwise, when one side of the CCFT is open, the excess current may possibly be applied to the other side of the lamp.

Recommended inverter is "CXA-P1212B-WJL(TDK corporation)".

[Note7] It is required to have the inverter designed so that to allow the impedance deviation of the two CCFT lamps and the capacity deviation of barast capacitor.

7. Timing characteristics of input signals

7-1. Timing characteristics

(These are specified at the digital inputs/outputs of LVDS transmitter/receiver.)

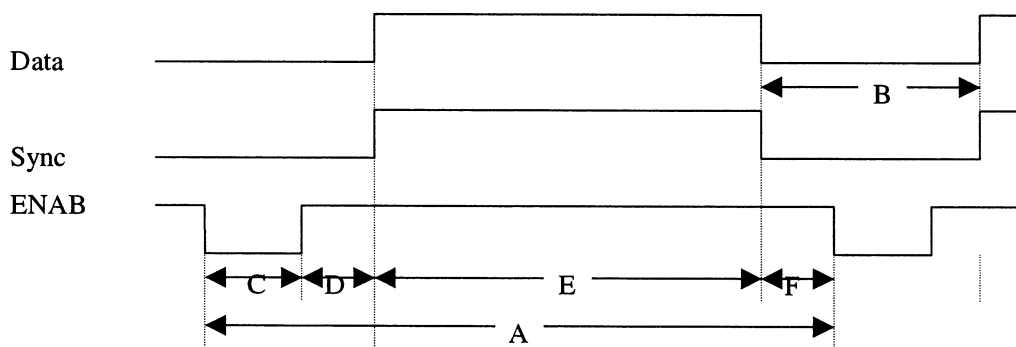

(Vertical timing)

Item(symbol)	Min.	Typ.	Max.	Unit	備考
Vsync cycle (T_{VA})	-	17.6	-	ms	Negative
	628	666	798	line	
Blanking period(T_{VB})	28	66	-	line	
Vsync pulse width (T_{VC})	2	4	6	line	
Back porch (T_{VD})	23	23	23	line	
Vsync pulse width+Back porch ($T_{VC}+T_{VD}$)	25	27	29	line	
Active display area (T_{VE})	600	600	600	line	
Front porch (T_{VF})	3	39	-	line	

(Horizontal timing)

Item(symbol)	Min.	Typ.	Max.	Unit	Remark
Hsync cycle (T_{HA})	20.8	26.4	39.9	us	Negative
	840	1056	1395	clock	
Blanking period (T_{HB})	40	256	-	clock	
Hsync pulse width (T_{HC})	2	128	200	clock	
Back porch (T_{HD})	$928-T_{HA}$	88	$T_{HA}-752$	clock	
Active display area (T_{HE})	800	800	800	clock	
Front porch (T_{HF})	0	40	-	clock	

(Clock signal)

Item	Min.	Typ.	Max.	Unit	Remark
Frequency	35	40	42	MHz	[Note1]

[Note1] In case of lower frequency, the deterioration of display quality, flicker etc., may be occurred.

(Hsync-Vsync Phase difference)

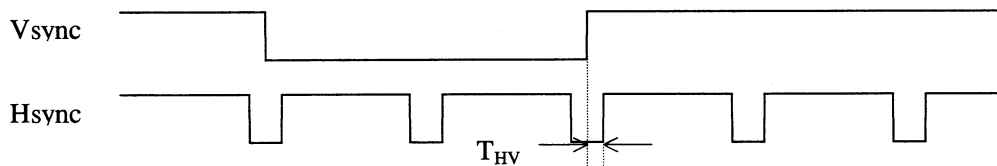

Item(symbol)	Min.	Typ.	Max.	Unit	Remark
Hsync-Vsync Phase difference (T_{HV})	1	-	$T_{HA}-T_{HC}$	clock	

(Hsync-ENAB Phase difference)

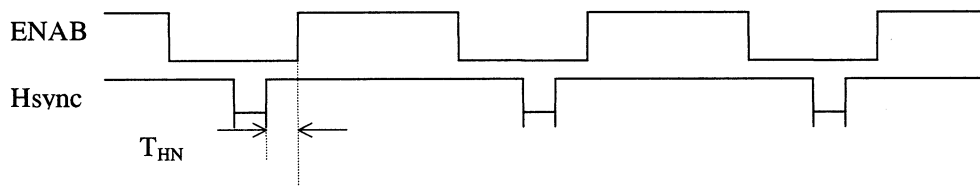

Item	Min.	Typ.	Max.	Unit	Remark
Hsync-ENAB Phase difference (T_{HN})	0	-	$T_{HA}-T_{HC}$ -800	clock	

7-2 Display position

Item	Standards	Beginning	Ending	Unit	Remark
Horizontal	rising edge of ENAB	0	800	clock	
	rising edge of Hsync	88	888	clock	[Note1]
Vertical	rising edge of Vsync	23	623	line	

[Note1] In case that ENAB signal is fixed to low level. Do not keep ENAB signal high during operation.

7-3. Input Data Signals and Display Position on the screen

Display position of input data
(H , V)

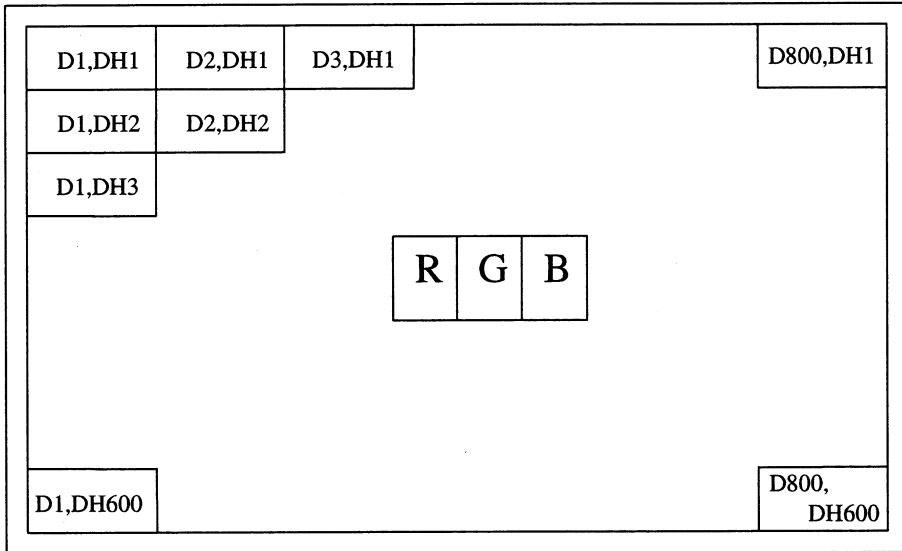

8. Input Signals, Basic Display Colors and Gray Scale of Each Color

Colors &	Data signal																			
	Gray scale	Gray Scale	R0	R1	R2	R3	R4	R5	G0	G1	G2	G3	G4	G5	B0	B1	B2	B3	B4	B5
Basic Color	Black	-	0	0	0	0	0	0	0	0	0	0	0	0	0	0	0	0	0	0
	Blue	-	0	0	0	0	0	0	0	0	0	0	0	0	1	1	1	1	1	1
	Green	-	0	0	0	0	0	0	1	1	1	1	1	1	0	0	0	0	0	0
	Cyan	-	0	0	0	0	0	0	1	1	1	1	1	1	1	1	1	1	1	1
	Red	-	1	1	1	1	1	1	0	0	0	0	0	0	0	0	0	0	0	0
	Magenta	-	1	1	1	1	1	1	0	0	0	0	0	0	1	1	1	1	1	1
	Yellow	-	1	1	1	1	1	1	1	1	1	1	1	1	0	0	0	0	0	0
	White	-	1	1	1	1	1	1	1	1	1	1	1	1	1	1	1	1	1	1
Gray Scale of Red	Black	GS0	0	0	0	0	0	0	0	0	0	0	0	0	0	0	0	0	0	0
	↑	GS1	1	0	0	0	0	0	0	0	0	0	0	0	0	0	0	0	0	0
	Darker	GS2	0	1	0	0	0	0	0	0	0	0	0	0	0	0	0	0	0	0
	↑	↓				↓					↓						↓			
	↓	↓				↓					↓						↓			
	Brighter	GS61	1	0	1	1	1	1	0	0	0	0	0	0	0	0	0	0	0	0
	↓	GS62	0	1	1	1	1	1	0	0	0	0	0	0	0	0	0	0	0	0
	Red	GS63	1	1	1	1	1	1	0	0	0	0	0	0	0	0	0	0	0	0
Gray Scale of Green	Black	GS0	0	0	0	0	0	0	0	0	0	0	0	0	0	0	0	0	0	0
	↑	GS1	0	0	0	0	0	0	1	0	0	0	0	0	0	0	0	0	0	0
	Darker	GS2	0	0	0	0	0	0	0	1	0	0	0	0	0	0	0	0	0	0
	↑	↓				↓					↓						↓			
	↓	↓				↓					↓						↓			
	Brighter	GS61	0	0	0	0	0	0	1	0	1	1	1	1	0	0	0	0	0	0
	↓	GS62	0	0	0	0	0	0	0	1	1	1	1	1	0	0	0	0	0	0
	Green	GS63	0	0	0	0	0	0	1	1	1	1	1	1	0	0	0	0	0	0
Gray Scale of Blue	Black	GS0	0	0	0	0	0	0	0	0	0	0	0	0	0	0	0	0	0	0
	↑	GS1	0	0	0	0	0	0	0	0	0	0	0	0	1	0	0	0	0	0
	Darker	GS2	0	0	0	0	0	0	0	0	0	0	0	0	0	1	0	0	0	0
	↑	↓				↓					↓						↓			
	↓	↓				↓					↓						↓			
	Brighter	GS61	0	0	0	0	0	0	0	0	0	0	0	0	1	0	1	1	1	1
	↓	GS62	0	0	0	0	0	0	0	0	0	0	0	0	0	1	1	1	1	1
	Blue	GS63	0	0	0	0	0	0	0	0	0	0	0	0	1	1	1	1	1	1

0 :Low level voltage, 1 : High level voltage

Each basic color can be displayed in 64 gray scales from 6 bit data signals. According to the combination of total 18 bit data signals, the 262,144-color display can be achieved on the screen.

9. Optical Characteristics

Ta=25°C, Vcc=+3.3V / +5.0V

Parameter	Symbol	Condition	Min.	Typ.	Max.	Unit	Remark
Viewing angle range	Horizontal	CR>10	60	70	-	Deg.	[Note1,4]
	Vertical		35	50	-	Deg.	
			55	60	-	Deg.	
Contrast ratio	CRn	$\theta = 0^\circ$	150	-	-		[Note2,4]
	CRo	Optimum viewing angle	-	450	-		
Response time	Rise	$\theta = 0^\circ$	-	15	-	ms	[Note3,4]
	Decay		-	30	-	ms	
Chromaticity of white	x	50% of the maximum brightness	-	0.313	-		[Note4] IL=6.0mArms f=60kHz
	y		-	0.329	-		
Luminance of white	Y_{L1}		300	370	-	cd/m ²	
White Uniformity	dW		-	-	1.25		
Viewing Angle range as a Brightness Definition	$\theta 21, \theta 22$	50% of the maximum brightness	-	35	-	Deg.	【Note1】 (Reference value)
	$\theta 11$		-	25	-	Deg.	
	$\theta 12$		-	30	-	Deg.	

※The measurement shall be executed 30 minutes after lighting at rating. (condition: $I_L = 6.0 \text{ mArms}$)

The optical characteristics shall be measured in a dark room or equivalent state with the method shown in Fig.3 below.

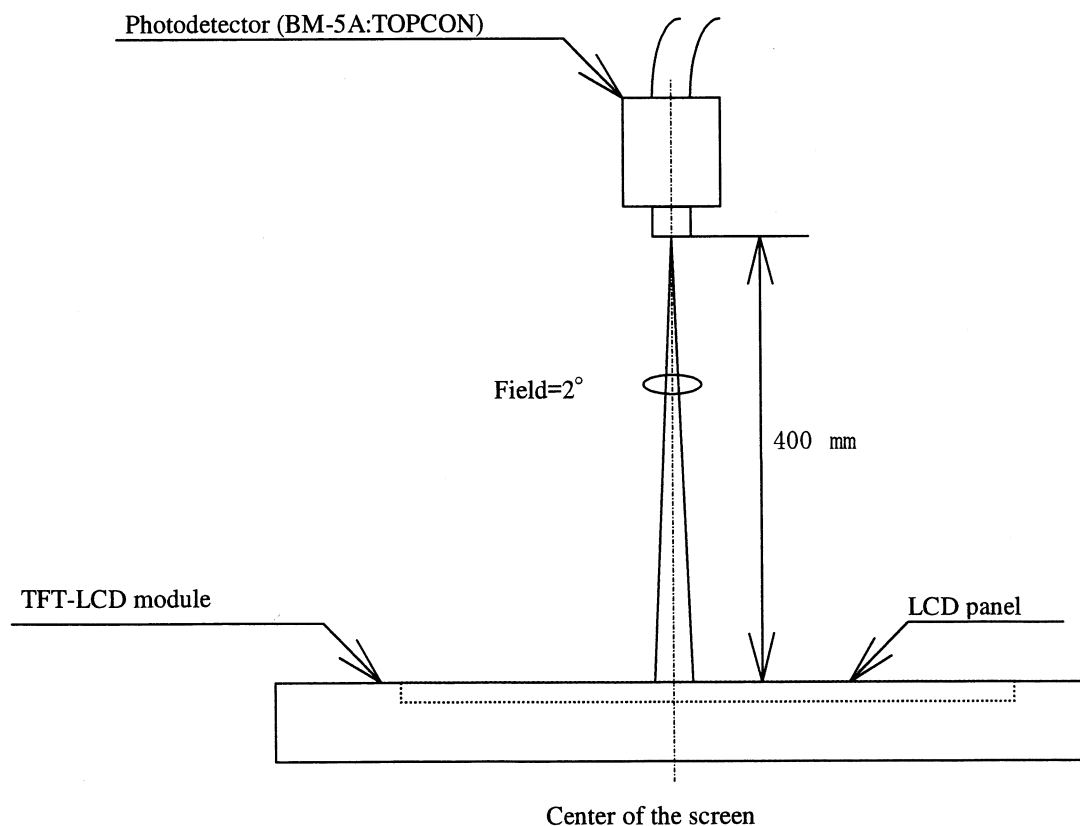
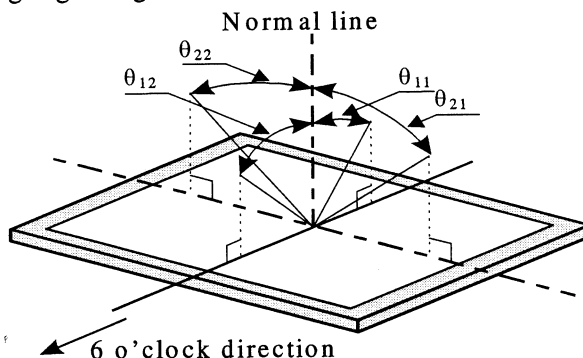

Fig.3 Optical characteristics measurement method

[Note1]Definitions of viewing angle range:



[Note2]Definition of contrast ratio:

The contrast ratio is defined as the following.

$$\text{Contrast Ratio (CR)} = \frac{\text{Luminance (brightness) with all pixels white}}{\text{Luminance (brightness) with all pixels black}}$$

[Note3]Definition of response time:

The response time is defined as the following figure and shall be measured by switching the input signal for "black" and "white".

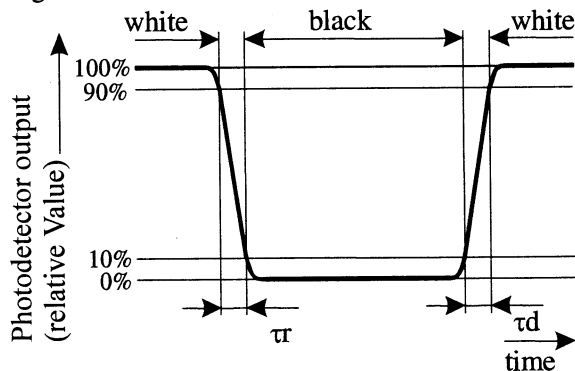

[Note4]This shall be measured at center of the screen.

[Note5]Definition of white uniformity:

White uniformity is defined as the following with five measurements (A~E).

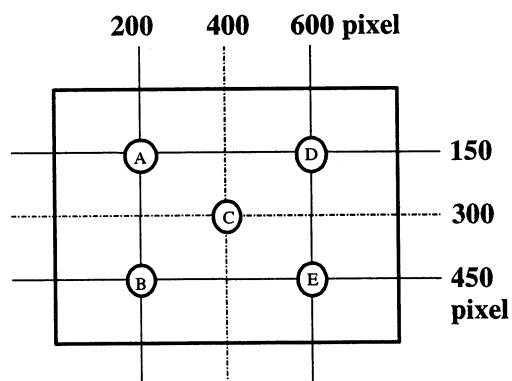

$$\delta_w = \frac{\text{Maximum Luminance of five points (brightness)}}{\text{Minimum Luminance of five points (brightness)}}$$

10. Display Quality

The display quality of the color TFT-LCD module shall be in compliance with the Incoming Inspection Standard.

11. Handling Precautions

- a) Be sure to turn off the power supply when inserting or disconnecting the cable.
- b) Be sure to design the cabinet so that the module can be installed without any extra stress such as warp or twist.
- c) Since the front polarizer is easily damaged, pay attention not to scratch it.
- d) Wipe off water drop immediately. Long contact with water may cause discoloration or spots.
- e) When the panel surface is soiled, wipe it with absorbent cotton or other soft cloth.
- f) Since the panel is made of glass, it may break or crack if dropped or bumped on hard surface. Handle with care.
- g) Since CMOS LSI is used in this module, take care of static electricity and injure the human earth when handling. Observe all other precautionary requirements in handling components.
- h) Protection film is attached to the module surface to prevent it from being scratched. Peel the film off slowly, just before the use, with strict attention to electrostatic charges. Blow off 'dust' on the polarizer by using an ionized nitrogen.
- i) The polarizer surface on the panel is treated with Anti-Glare for low reflection. In case of attaching protective board over the LCD, be careful about the optical interface fringe etc. which degrades display quality.
- j) Do not expose the LCD panel to direct sunlight. Lightproof shade etc. should be attached when LCD panel is used under such environment.
- k) Connect GND to 4 place of mounting holes to stabilize against EMI and external noise.
- l) There are high voltage portions on the backlight and very dangerous. Careless touch may lead to electrical shock. When exchange lamps or service, turn off the power without fail.
- m) When handling LCD modules and assembling them into cabinets, please be noted that long-term storage in the environment of oxidization or deoxidization gas and the use of such materials as reagent, solvent, adhesive, resin, etc. which generate these gasses, may cause corrosion and discoloration of the LCD modules.
- n) Cold cathode fluorescent lamp in LCD panel contains a small amount of mercury, please follow local ordinances or regulations for disposal.

12. Packing form

- a) Piling number of cartons : MAX. 5
- b) Package quantity in one carton : 10pcs
- c) Carton size : 395(W)×275(H)×350(D) mm
- d) Total mass of one carton filled with full modules : 8000g

13. Reliability test items

No.	Test item	Conditions
1	High temperature storage test	Ta=70 °C 240h
2	Low temperature storage test	Ta=-30 °C 240h
3	High temperature & high humidity operation test	Ta=40 °C ; 95%RH 240h (No condensation)
4	High temperature operation test	Ta=65 °C 240h
5	Low temperature operation test	Ta=-10 °C 240h
6	Vibration test (non- operating)	Frequency :10~57Hz/Vibration width (one side):0.075mm : 58~500Hz/Gravity:9.8m/s ² Sweep time : 11 minutes Test period : 3 hours (1 hour for each direction of X,Y,Z)
7	Shock test (non- operating)	Max. gravity : 490m/s ² Pulse width : 11ms, sine wave Direction : +/- X, +/- Y, +/- Z once for each direction.

[Result Evaluation Criteria]

Under the display quality test conditions with normal operation state, these shall be no change which may affect practical display function.

14. Others

1) Lot No. Label:



- 2) Adjusting volume have been set optimally before shipment, so do not change any adjusted value.
If adjusted value is changed, the specification may not be satisfied.
- 3) Disassembling the module can cause permanent damage and should be strictly avoided.
- 4) Please be careful since image retention may occur when a fixed pattern is displayed for a long time.
- 5) If any problem occurs in relation to the description of this specification , it shall be resolved through discussion with spirit of cooperation.

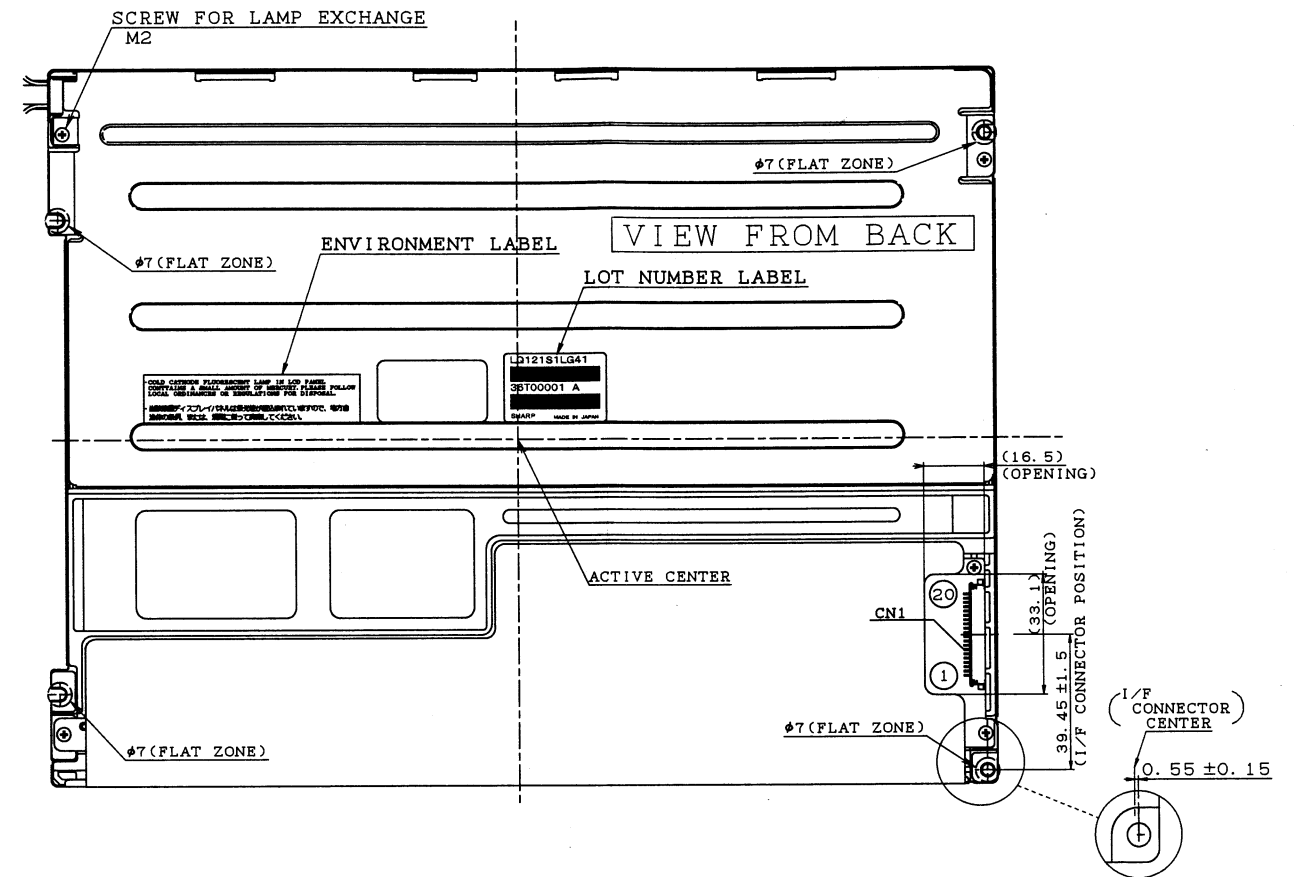
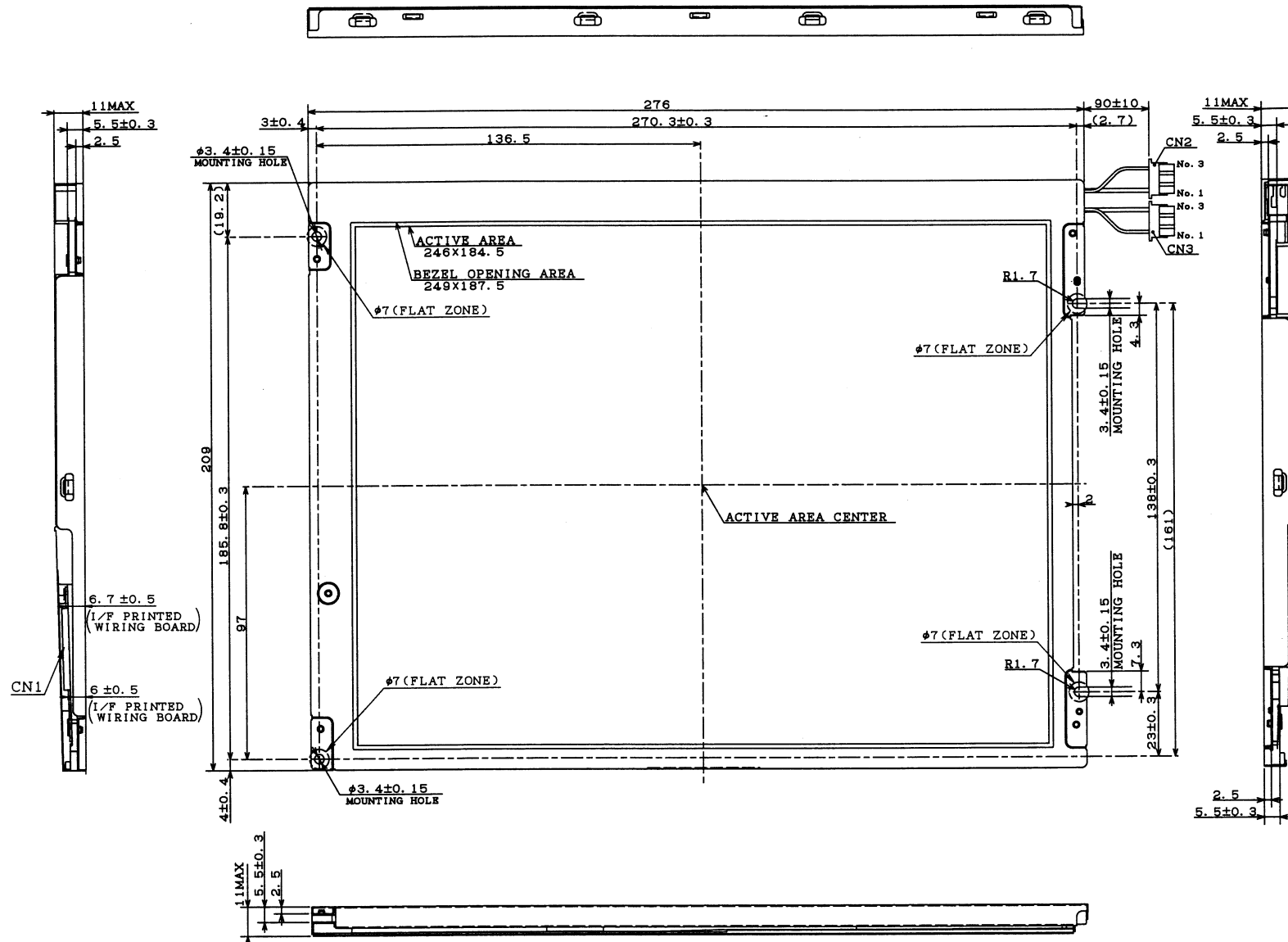

INTERFACE CONNECTOR
PIN LAYOUT

pin	1	2	3	4	5	6	7
	VCC	VCC	GND	GND	RXINO-	RXINO+	GND
8	9	10	11	12	13	14	15
RXIN1-	RXIN1+	GND	RXIN2-	RXIN2+	GND	RCLKIN-	RCLKIN+
16	17	18	19	20			
GND	R/L	U/D	GND	GND			

CORRESPONDING CONNECTOR: FI-SE20M, FI-S20S

BEZEL/DISPLAY POSITION

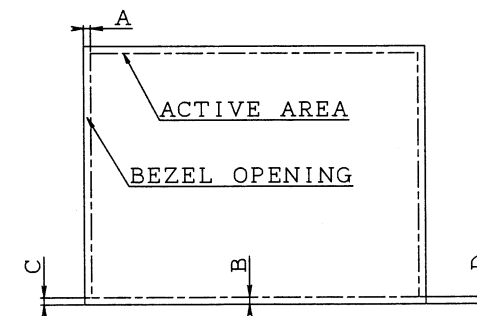

- 1) TOLERANCE X-DIRECTION A: 1.5 ± 0.8
- 2) TOLERANCE Y-DIRECTION B: 1.5 ± 0.8
- 3) OBLIQUITY OF DISPLAY AREA $|C-D| < 0.8$

CCFT CONNECTOR
CN2, CN3: BHR-03VS-1 (JST)
PIN LAYOUT

1	High
2	NC
3	GND

NOTES

- 1. UNSPECIFIED TOLERANCE TO BE ± 0.5
- 2. WARP AND FLATING FOR PCB AND CHASSIS ARE EXCLUDED FROM THICKNESS AND DIMENSION OF THE UNIT.

Fig 1. OUTLINE DIMENSIONS
(LQ121SILG41)

D/N: 2D-035-143-01

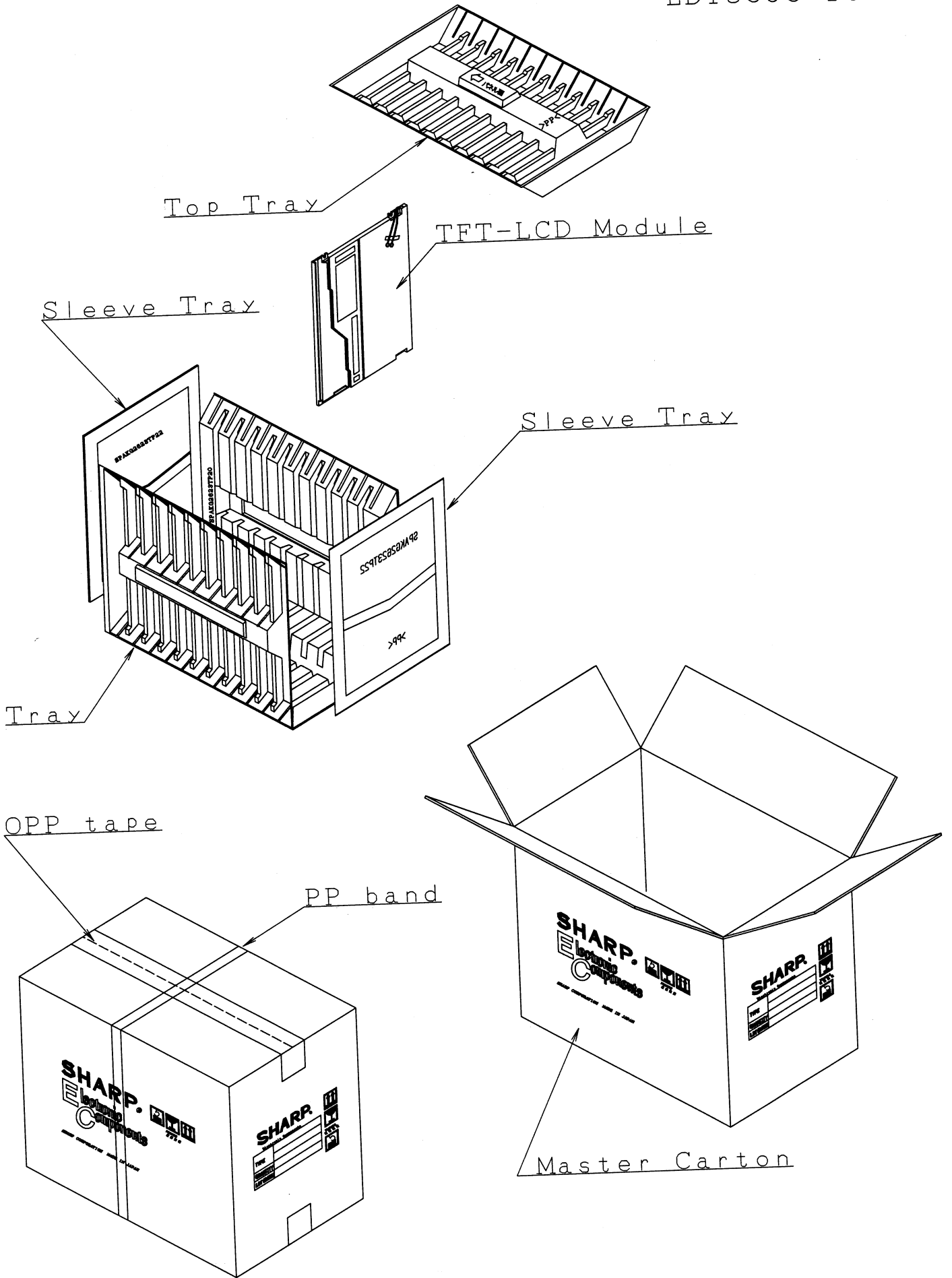

Packing Form

SPECIFICATIONS ARE SUBJECT TO CHANGE WITHOUT NOTICE.

Suggested applications (if any) are for standard use; See Important Restrictions for limitations on special applications. See Limited Warranty for SHARP's product warranty. The Limited Warranty is in lieu, and exclusive of, all other warranties, express or implied. ALL EXPRESS AND IMPLIED WARRANTIES, INCLUDING THE WARRANTIES OF MERCHANTABILITY, FITNESS FOR USE AND FITNESS FOR A PARTICULAR PURPOSE, ARE SPECIFICALLY EXCLUDED. In no event will SHARP be liable, or in any way responsible, for any incidental or consequential economic or property damage.

SHARP®

NORTH AMERICA

SHARP Microelectronics of the Americas
5700 NW Pacific Rim Blvd.
Camas, WA 98607, U.S.A.
Phone: (1) 360-834-2500
Fax: (1) 360-834-8903
Fast Info: (1) 800-833-9437
www.sharpsma.com

EUROPE

SHARP Microelectronics Europe
Division of Sharp Electronics (Europe) GmbH
Sonninstrasse 3
20097 Hamburg, Germany
Phone: (49) 40-2376-2286
Fax: (49) 40-2376-2232
www.sharpsme.com

JAPAN

SHARP Corporation
Electronic Components & Devices
22-22 Nagaike-cho, Abeno-Ku
Osaka 545-8522, Japan
Phone: (81) 6-6621-1221
Fax: (81) 6117-725300/6117-725301
www.sharp-world.com

TAIWAN

SHARP Electronic Components
(Taiwan) Corporation
8F-A, No. 16, Sec. 4, Nanking E. Rd.
Taipei, Taiwan, Republic of China
Phone: (886) 2-2577-7341
Fax: (886) 2-2577-7326/2-2577-7328

SINGAPORE

SHARP Electronics (Singapore) PTE., Ltd.
438A, Alexandra Road, #05-01/02
Alexandra Technopark,
Singapore 119967
Phone: (65) 271-3566
Fax: (65) 271-3855

KOREA

SHARP Electronic Components
(Korea) Corporation
RM 501 Geosung B/D, 541
Dohwa-dong, Mapo-ku
Seoul 121-701, Korea
Phone: (82) 2-711-5813 ~ 8
Fax: (82) 2-711-5819

CHINA

SHARP Microelectronics of China
(Shanghai) Co., Ltd.
28 Xin Jin Qiao Road King Tower 16F
Pudong Shanghai, 201206 P.R. China
Phone: (86) 21-5854-7710/21-5834-6056
Fax: (86) 21-5854-4340/21-5834-6057

Head Office:

No. 360, Bashen Road,
Xin Development Bldg. 22
Waigaoqiao Free Trade Zone Shanghai
200131 P.R. China
Email: smc@china.global.sharp.co.jp

HONG KONG

SHARP-ROXY (Hong Kong) Ltd.
3rd Business Division,
17/F, Admiralty Centre, Tower 1
18 Harcourt Road, Hong Kong
Phone: (852) 28229311
Fax: (852) 28660779
www.sharp.com.hk

Shenzhen Representative Office:

Room 13B1, Tower C,
Electronics Science & Technology Building
Shen Nan Zhong Road
Shenzhen, P.R. China
Phone: (86) 755-3273731
Fax: (86) 755-3273735