

| | |
|-------|------------|
| 仕様書番号 | FU-16-004 |
| 発行日 | 2008.06.30 |

御 中

仕 様 書

品名 TFT-LCDモジュール

型名 FU-16-004

備 考

画面鏡面タイプ

**164M1LA4A

FUKUGAKI CO.,LTD

LD20608A-1

These specification sheets are the proprietary product of SHARP CORPORATION("SHARP) and include materials protected under copyright of SHARP. Do not reproduce or cause any third party to reproduce them in any form or by any means, electronic or mechanical, for any purpose, in whole or in part, without the express written permission of SHARP.

In case of using the device for applications such as control and safety equipment for transportation(aircraft, trains, automobiles, etc.), rescue and security equipment and various safety related equipment which require higher reliability and safety, take into consideration that appropriate measures such as fail-safe functions and redundant system design should be taken.

Do not use the device for equipment that requires an extreme level of reliability, such as aerospace applications, telecommunication equipment(trunk lines), nuclear power control equipment and medical or other equipment for life support.

SHARP assumes no responsibility for any damage resulting from the use of the device, which does not comply with the instructions, and the precautions specified in these specification sheets.

Confirm "11. Handling Precautions " item when you use the device.

Contact and consult with a SHARP sales representative for any questions about this device.

Table of contents

| | |
|---|----|
| 1. Application | 3 |
| 2. Overview | 3 |
| 3. Mechanical Specifications | 3 |
| 4. Input Terminals | 4 |
| 4-1. TFT-LCD panel driving | 4 |
| 4-2. Interface block diagram | 5 |
| 4-3. Backlight driving | 6 |
| 5. Absolute Maximum Ratings | 6 |
| 6. Electrical Characteristics | 6 |
| 6-1. TFT-LCD panel driving | 6 |
| 6-2. Backlight driving | 8 |
| 6-3. LVDS Input specification | 10 |
| 6.3.1. AC characteristics | 10 |
| 6.3.2. LVDS data | 11 |
| 7. Timing Characteristics of Input Signals | 12 |
| 7-1. Timing characteristics | 12 |
| 7-2. Input data signals and display position on the screen | 13 |
| 8. Input Signals, Basic Display Colors and Gray Scale of Each Color | 14 |
| 9. Optical Characteristics | 15 |
| 10. Display Quality | 16 |
| 11. Handling Precautions | 17 |
| 12. Packing form | 18 |
| 13. Reliability Test Items | 18 |
| 14. Label | 19 |
| 15. RoHS Regulations | 20 |
| Fig.1 Packing Form | 21 |
| Fig.2 Outline Dimensions | 22 |

LD20608A-3

1. Application

This specification applies to a color TFT-LCD module, LQ164M1LA4A.

2. Overview

This module is a color active matrix LCD module incorporating amorphous silicon TFT (Thin Film Transistor). It is composed of a color TFT-LCD panel, driver ICs, control circuit and power supply circuit and a backlight unit. Graphics and texts can be displayed on a 1920×3×1080 dots panel with 262,144 colors by using LVDS (Low Voltage Differential Signaling) to interface and supplying +3.3V DC supply voltage for TFT-LCD panel driving and supply voltage for backlight.

In this TFT-LCD panel, low reflection / color filters of excellent color performance and backlights of high brightness are incorporated to realize brighter and clearer pictures, making this model optimum for use in multi-media applications.

Optimum viewing direction is 6 o'clock.

Backlight-driving DC/AC inverter is not built in this module.

3. Mechanical Specifications

| Parameter | Specifications | Unit |
|---------------------|---|-------|
| Display size | 41.7(16.4") Diagonal | cm |
| Active area | 362.9 (H)× 204.1(V) | mm |
| Pixel format | 1920(H)×1080(V) | pixel |
| | (1 pixel = R+G+B dots) | |
| Aspect ratio | 16 : 9 | |
| Pixel pitch | 0.189(H)×0.189 (V) | mm |
| Pixel configuration | R,G,B vertical stripe | |
| Display mode | Normally white | |
| Surface treatment | Glare and hard-coating 2H Low reflection | |

| Parameter | | Min. | Typ. | Max. | Unit |
|-------------------------------------|--------|-------|-------|-------|------|
| Unit outline dimensions [Note 1] | Width | 374.5 | 375.0 | 375.5 | mm |
| | Height | 221.6 | 222.1 | 222.6 | mm |
| | Depth | — | — | 7.0 | mm |
| Mass | | — | 635 | 650 | g |

[Note 1] excluding backlight cables.

Outline dimensions is shown in Fig.2

4. Input Terminals

4-1. TFT-LCD panel driving

CN1 (LVDS signals and +3.3V DC power supply)

| Pin No. | Symbol | Function | Remark |
|---------|---------|-------------------------------------|----------|
| 1 | GND | | |
| 2 | Vcc | +3.3V power supply | |
| 3 | Vcc | +3.3V power supply | |
| 4 | NC | | [Note 3] |
| 5 | NC | | [Note 3] |
| 6 | NC | | [Note 3] |
| 7 | NC | | [Note 3] |
| 8 | R1IN0- | Receiver signal of A side pixel (-) | [Note 1] |
| 9 | R1IN0+ | Receiver signal of A side pixel (+) | [Note 1] |
| 10 | GND | | |
| 11 | R1IN1- | Receiver signal of A side pixel (-) | [Note 1] |
| 12 | R1IN1+ | Receiver signal of A side pixel (+) | [Note 1] |
| 13 | GND | | |
| 14 | R1IN2- | Receiver signal of A side pixel (-) | [Note 1] |
| 15 | R1IN2+ | Receiver signal of A side pixel (+) | [Note 1] |
| 16 | GND | | |
| 17 | CK1 IN- | Clock signal of A side pixel (-) | [Note 1] |
| 18 | CK1 IN+ | Clock signal of A side pixel (+) | [Note 1] |
| 19 | GND | | |
| 20 | R2IN0- | Receiver signal of B side pixel (-) | [Note 1] |
| 21 | R2IN0+ | Receiver signal of B side pixel (+) | [Note 1] |
| 22 | GND | | |
| 23 | R2IN1- | Receiver signal of B side pixel (-) | [Note 1] |
| 24 | R2IN1+ | Receiver signal of B side pixel (+) | [Note 1] |
| 25 | GND | | |
| 26 | R2IN2- | Receiver signal of B side pixel (-) | [Note 1] |
| 27 | R2IN2+ | Receiver signal of B side pixel (+) | [Note 1] |
| 28 | GND | | |
| 29 | CK2 IN- | Clock signal of B side pixel (-) | [Note 1] |
| 30 | CK2 IN+ | Clock signal of B side pixel (+) | [Note 1] |

[Note 1] Relation between RxIN_i(i=0,1,2) and actual data is shown in following section (4-2)(7-2).

[Note 2] The shielding case is connected with signal GND.

[Note 3] Please use NC by OPEN or GND. NC terminal is not connected with the internal circuit.

Using connector : FI-XPB30SRL-HF11 (JAE) or equivalent.

Corresponding connector : FI-X30M,FI-X30ML or FI-X30H (JAE)

(Sharp is not responsible to its product quality, if the user applies a connector not corresponding to the above model.)

LD20608A-5

4-2 LVDS interface block diagram

Using receiver : Dual LVDS interface contained in a control IC
 Corresponding Transmitter : THC63LVDM63A (THINE) or equivalent

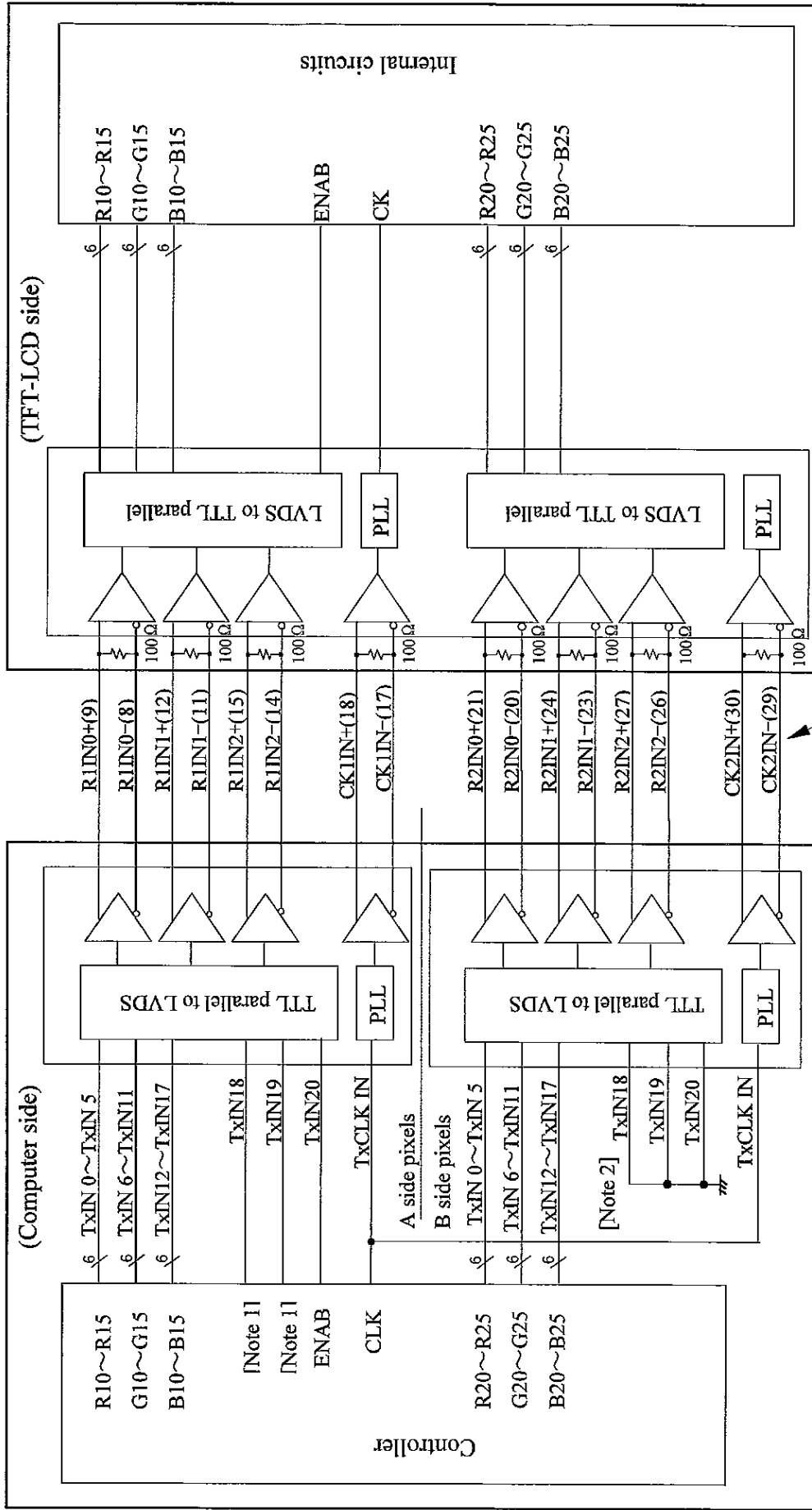

Symbol of CN1 (Pin No.)

[Note 1] Do not use at high-impedance for pixels on A side's TxIN 18 - 19.

[Note 2] Please connect B side pixels, TxIN 18 - 19 to GND.

4-3. Backlight driving

CN2,CN3 Using connector:BHSR-02VS-1(JST)

Corresponding connector : SM02B-BHSS-1-TB(JST)

(Sharp is not responsible to its product quality, if the user applies a connector not corresponding to the above model.)

| Connector No. | Pin No. | Symbol | Function | FL cable color |
|---------------|---------|-------------------|---|----------------|
| CN2 | 1 | V _{High} | Power supply for lamp (High voltage side) | Pink |
| | 2 | V _{Low} | Power supply for lamp (Low voltage side) | Brown |
| CN3 | 1 | V _{High} | Power supply for lamp (High voltage side) | Blue |
| | 2 | V _{Low} | Power supply for lamp (Low voltage side) | Black |

5. Absolute Maximum Ratings

| Parameter | Symbol | Condition | Ratings | | Unit | Remark |
|---------------------------------|------------------|-----------|---------|----------------------|------------------|----------|
| | | | Min. | Max. | | |
| Input voltage | V _I | Ta=25°C | -0.3 | V _{CC} +0.3 | V | [Note 1] |
| +3.3V supply voltage | V _{CC} | Ta=25°C | 0 | +4.0 | V | |
| Lamp voltage | V _{La} | Ta=25°C | — | 2000 | V _{rms} | [Note 2] |
| Storage temperature | T _{stg} | — | -25 | +60 | °C | [Note 3] |
| Operating temperature (Ambient) | T _{opa} | — | 0 | +50 | °C | |

[Note 1] LVDS signals

[Note 2] Lamp(CCFT) voltage

[Note 3] Humidity : 95%RH Max. at Ta≤+45°C.

Maximum wet-bulb temperature at +44°C or less at Ta>+45°C.

No condensation.

6. Electrical Characteristics

6-1. TFT-LCD panel driving

Ta=+25°C

| Parameter | Symbol | Min. | Typ. | Max. | Unit | Remark | |
|--------------------------------------|-----------------|-----------------|------|------|-------------------|--|-------------------------------------|
| Supply voltage | V _{CC} | +3.0 | +3.3 | +3.6 | V | [Note 2] | |
| Current dissipation | I _{CC} | — | 450 | 720 | mA | [Note 3] | |
| Permissive input ripple voltage | V _{RP} | — | — | 100 | mV _{p-p} | V _{CC} = +3.3V | |
| Input voltage range | V _I | 0 | — | 2.4 | V | LVDS signals | |
| Differential input threshold voltage | High | V _{TH} | — | — | +100 | mV | V _{CM} = +1.2V [Note 1] |
| | Low | V _{TL} | -100 | — | — | mV | |
| Input current (High) | I _{OH} | — | — | ±10 | μA | V _I = +2.4V V _{CC} = +3.6V | |
| Input current (Low) | I _{OL} | — | — | ±10 | μA | V _I = 0V V _{CC} = 3.6V | |
| Terminal resistor | R _T | — | 100 | — | Ω | Differential input | |

[Note 1] V_{CM} : Common mode voltage of LVDS driver.

[Note 2]

On-off conditions for supply voltage

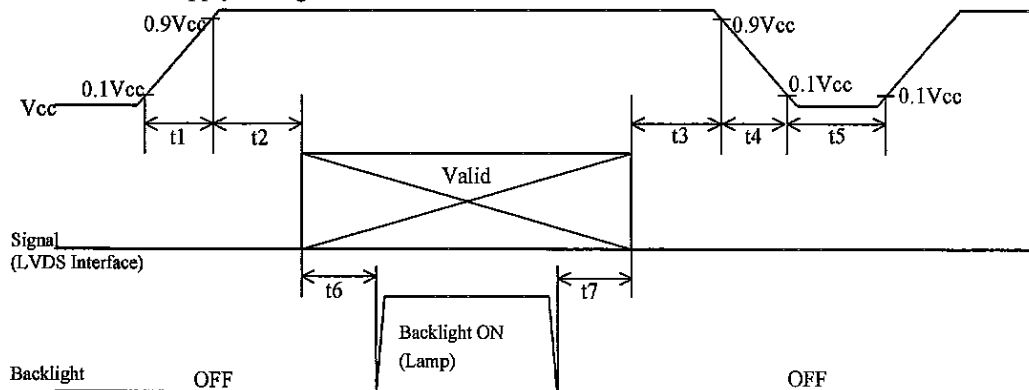

| Symbol | Min. | Max. | Unit | Remark |
|--------|------|------|------|--------|
| t1 | 0 | 10 | ms | |
| t2 | 0 | 1 | s | |
| t3 | 0 | 1 | s | |
| t4 | 0 | 400 | ms | |
| t5 | 200 | — | ms | |
| t6 | 180 | — | ms | *1 |
| t7 | 5 | — | ms | *1 |

*1 : As for the power sequence for backlight, it is recommended to apply above mentioned input timing. If the backlight is lit on and off at a timing other than shown above, displaying image may get disturbed. This is due to variation of output signal from timing generator when LVDS signal is changed from on to off or vice versa, but has no harm to the module itself.

[Note] Do not keep the interface signal high-impedance or unusual signal when power is on.

Vcc-dip conditions

- 1) $2.5\text{ V} \leq V_{cc} < 3.0\text{ V}$

$t_d \leq 10\text{ ms}$

Under above condition, the display image should return to an appropriate figure after Vcc voltage recovers.

- 2) $V_{cc} < 2.5\text{ V}$

Vcc-dip conditions should also follow the On-off conditions for supply voltage

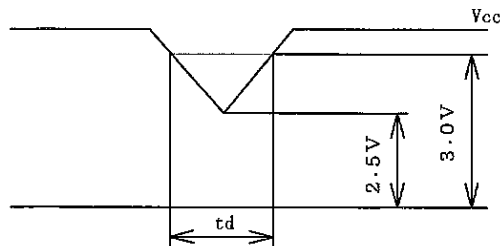

[Note 3] Typical current situation : 16-gray-bar pattern.

$V_{cc} = +3.3\text{ V}$

Maximum current situation : $V_{cc} = +3.0\text{ V}$

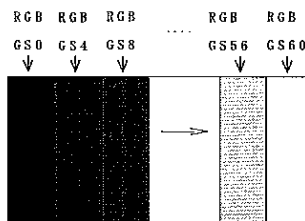

6-2. Backlight driving

The backlight system is edge-lighting type with two CCFTs (Cold Cathode Fluorescent Tube).

The characteristics of one lamp are shown in the following table.

| Parameter | Symbol | Min. | Typ. | Max. | Unit | Remark | |
|------------------------|--------|-------|------|------|-------|------------------------|----------|
| Lamp current range | I_L | 3.0 | 6.0 | 6.5 | mArms | [Note 1] | |
| Lamp voltage | V_L | — | 725 | — | Vrms | | |
| Lamp power consumption | P_L | — | 4.4 | — | W | [Note 2] | |
| Lamp frequency | F_L | 40 | 58 | 80 | kHz | [Note 3] | |
| Kick-off voltage | V_s | — | — | 1392 | Vrms | $T_a=25^\circ\text{C}$ | [Note 4] |
| | | — | — | 1600 | Vrms | $T_a=0^\circ\text{C}$ | |
| Lamp life time | L_L | 12000 | — | — | Hour | [Note 5] | |

[Note 1] The lamp current range, which can be turned on, is shown.

Lamp current measures by connecting the ammeter for high frequency to the V_{Low} side in the circuit of the following figure.

- Lamp frequency : 40~80kHz
- Temperature (Ambient) : 0~+50°C

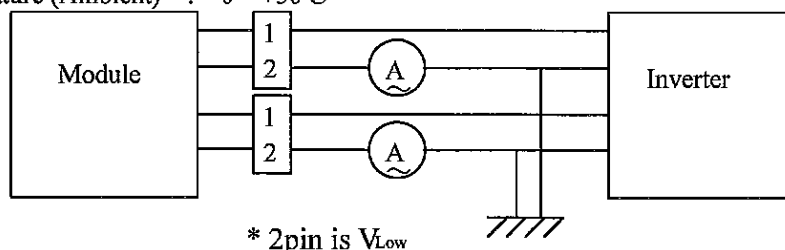

In addition, please check lighting starting nature and lighting stability after mounting a module and an inverter on the occasion of use in a low current region.

[Note 2] Calculated value for reference ($I_L \times V_L$)

[Note 3] Lamp frequency may produce interference with horizontal synchronous frequency, and this may cause beat on the display. Therefore lamp frequency shall be detached as much as possible from the horizontal synchronous frequency and from the harmonics of horizontal synchronous to avoid interference.

[Note 4] It is defined at 22pF for the ballast capacitor of a DC/AC inverter.

The voltage above this value should be applied to the lamp for more than 1 second to start-up. Otherwise the lamp may not be turned on.

[Note 5] Above value is applicable when lamp is placed horizontally.

Lamp life time is defined that it applied either ① or ② under this condition
(Continuous turning on at $T_a=25^\circ\text{C}$, $I_L=6.5\text{mArms}$)

① Brightness becomes 50% of the original value under standard condition.

② Kick-off voltage at $T_a=0^\circ\text{C}$ exceeds maximum value, (1,600)Vrms.

(Lamp life time may vary if lamp is in portrait position due to the change of mercury density inside the lamp.)

Lamp life time shortens according to the state of mounting and use.

In case of operating under lower temp environment, the lamp exhaustion is accelerated and the brightness becomes lower.(Continuous operating for around 1 month under lower temp condition may reduce the brightness to half of the original brightness.)

[Note6] The performance of the backlight, for example life time or brightness, is much influenced by the characteristics of the DC-AC inverter for the lamp. When you design or order the inverter, please make sure that a poor lighting caused by the mismatch of the backlight and the inverter (miss-lighting, flicker, etc.) never occur. When you confirm it, the module should be operated in the same condition as it is installed in your instrument.

Be sure to use a back light power supply with the safety protection circuit such as the detection circuit for the excess voltage, excess current and or electric discharge waveform.

Be sure to use the detect circuit by which one side of the CCFT lamps can be controlled independently. Otherwise, when one side of the CCFT is open, the excess current may possibly be applied to the other side of the lamp.

LD20608A-9

[Note 7] Insulate the high voltage area in order to prevent direct contacts to the area. As countermeasures for excessive heat or exothermic fire, use protection elements such as fuses to cut the circuit. Use burn-resistant (or noncombustible) material for board or resin.

[Note8] A lamp waveform should satisfy the following conditions.

Crest factor : $1.20 \leq I_p(P) / I_{rms} \text{ or } I_p(N) / I_{rms} \leq 1.63$
Imbalanced value: $0.95 \leq I_p(P) / I_p(N) \leq 1.05$

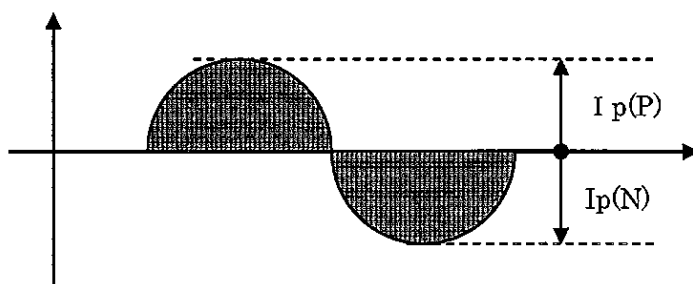

6-3. LVDS input specification

6.3.1. AC characteristics

V_{CC}=+3.0V~+3.6V, T_a=0°C~+50°C

| Parameter | Symbol | Min | Typ. | Max. | Unit |
|--|-------------------|-----------------------------|------------------------|-----------------------------|------|
| Input Data Position 0 (t _{RCIP} =15.38ns) | t _{RIP1} | -0.25 | 0.0 | +0.25 | ns |
| Input Data Position 1 (t _{RCIP} =15.38ns) | t _{RIP0} | t _{RCIP} /7-0.25 | t _{RCIP} /7 | t _{RCIP} /7+0.25 | ns |
| Input Data Position 2 (t _{RCIP} =15.38ns) | t _{RIP6} | 2 t _{RCIP} /7-0.25 | 2 t _{RCIP} /7 | 2 t _{RCIP} /7+0.25 | ns |
| Input Data Position 3 (t _{RCIP} =15.38ns) | t _{RIP5} | 3 t _{RCIP} /7-0.25 | 3 t _{RCIP} /7 | 3 t _{RCIP} /7+0.25 | ns |
| Input Data Position 4 (t _{RCIP} =15.38ns) | t _{RIP4} | 4 t _{RCIP} /7-0.25 | 4 t _{RCIP} /7 | 4 t _{RCIP} /7+0.25 | ns |
| Input Data Position 5 (t _{RCIP} =15.38ns) | t _{RIP3} | 5 t _{RCIP} /7-0.25 | 5 t _{RCIP} /7 | 5 t _{RCIP} /7+0.25 | ns |
| Input Data Position 6 (t _{RCIP} =15.38ns) | t _{RIP2} | 6 t _{RCIP} /7-0.25 | 6 t _{RCIP} /7 | 6 t _{RCIP} /7+0.25 | ns |
| Phase Lock Loop Set | t _{RPLL} | — | — | 10 | ms |
| Input Clock Period | t _{RCIP} | 13.2 | 13.5 | 16.6 | ns |
| Skew Time between CK1IN and CK2IN | t _{CK12} | -2.0 | 0.0 | +2.0 | ns |

AC Timing Diagrams LVDS Inputs

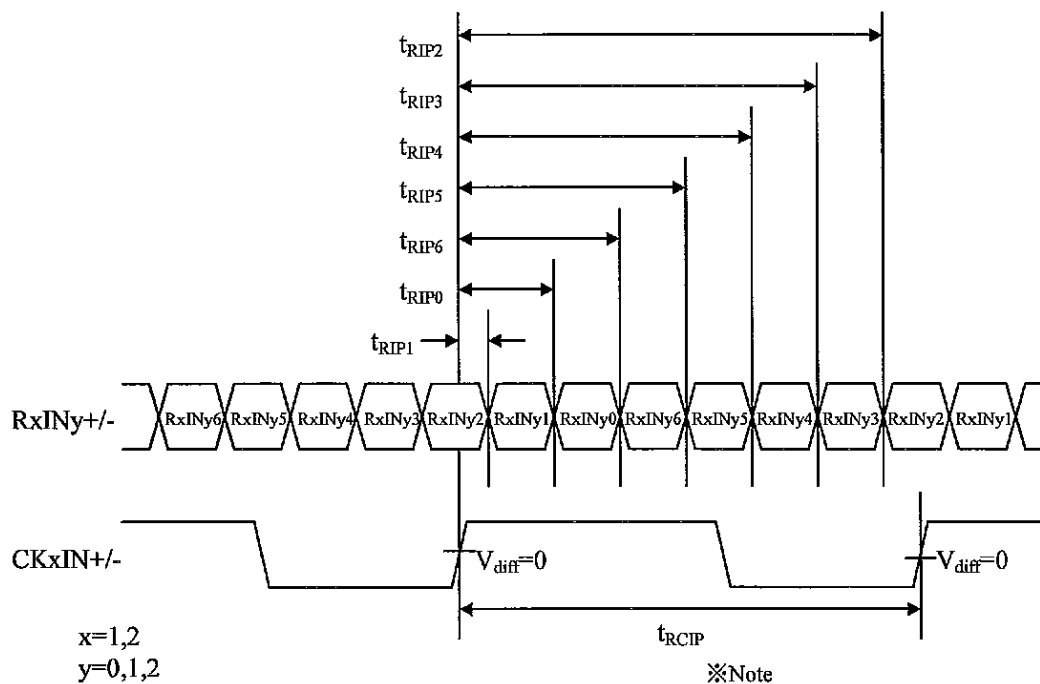

※Note
V_{diff}=(RxINy+)-(RxINy-), (CKxIN+)-(CKxIN-)

AC Timing Diagrams LVDS Input CLK Skew

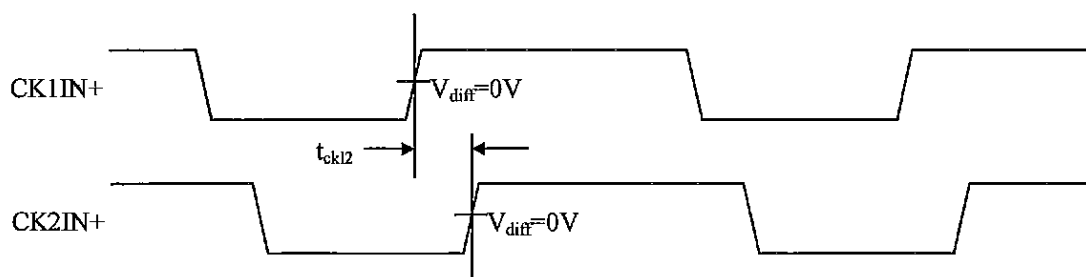

LVDS Phase Lock Loop Set

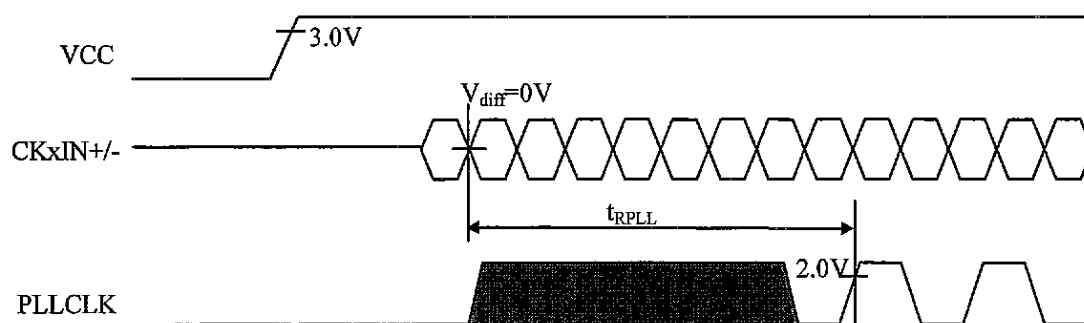

6.3.2.LVDS Data Input Timing

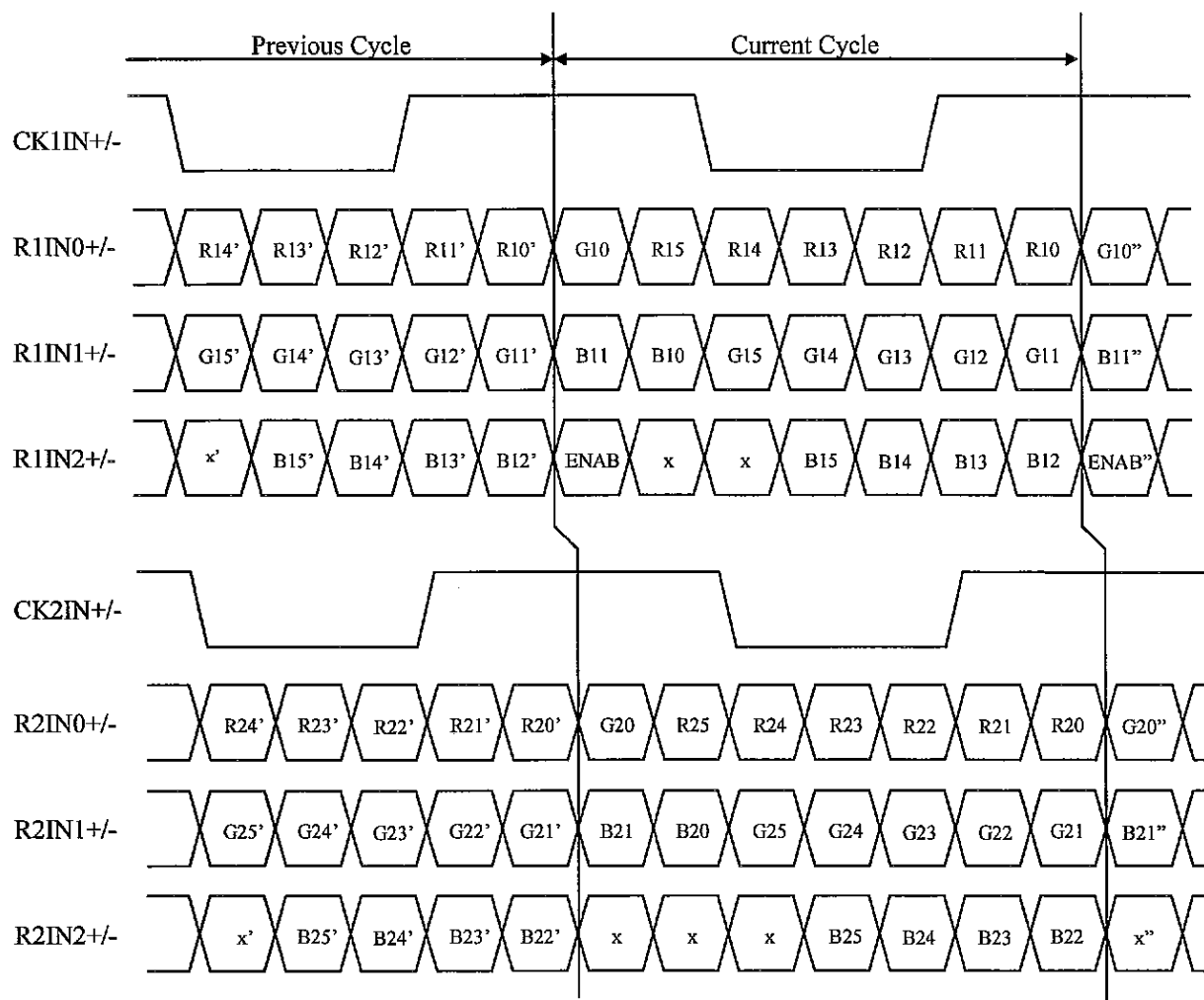

7. Timing Characteristics of Input Signals

7-1. Timing characteristics

Vcc=+3.0V~+3.6V, Ta=0°C~+50°C

| Parameter | Symbol | Min. | Typ. | Max. | Unit | Remark |
|------------------------|--------------------------|------|-------|-------|------|--------------|
| Clock | Frequency | 1/Tc | 60 | 74.0 | 76.0 | MHz [Note 1] |
| Data enable Signal | Horizontal period | TH | 1030 | 1096 | 1650 | clock |
| | | | 13.9 | 14.8 | — | μs |
| | Horizontal period (High) | THd | 960 | 960 | 960 | clock |
| | Vertical period | TV | 1111 | 1125 | 1360 | Line |
| | | | 16.66 | 16.66 | — | ms |
| Vertical period (High) | TVd | 1080 | 1080 | 1080 | line | |

[Note 1] In case of using the long vertical period, the deterioration of display quality, flicker, etc, may occur.

[Note 2] Display position is determined by “ENAB” signal, “Hsync” and “Vsync” are ignored.

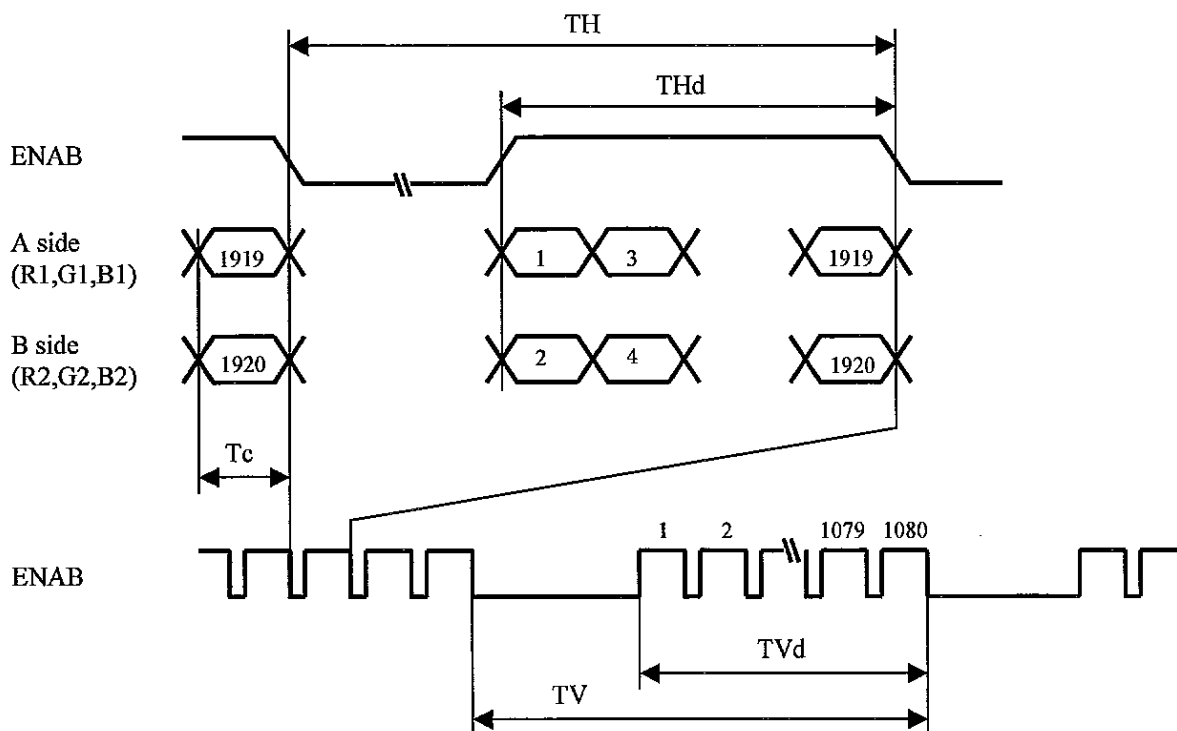

7-2. Input Data Signals and Display Position on the screen

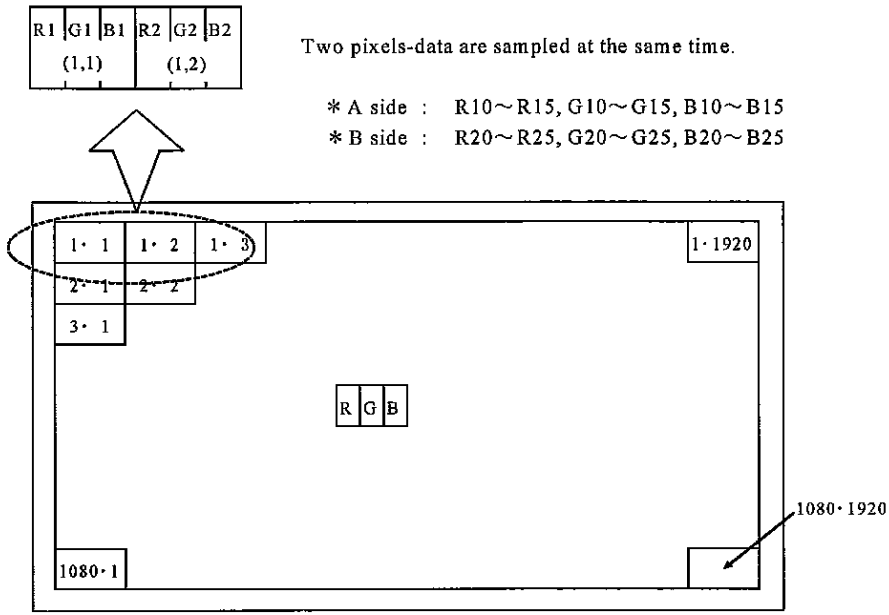

Display position of input data(V · H)

8. Input Signals, Basic Display Colors and Gray Scale of Each Color

| | Colors & | Data signal | | | | | | | | | | | | | | | | | | |
|---------------------|------------|-------------|----|----|----|----|----|----|----|----|----|----|----|----|----|----|----|----|----|----|
| | Gray scale | Gray Scale | R0 | R1 | R2 | R3 | R4 | R5 | G0 | G1 | G2 | G3 | G4 | G5 | B0 | B1 | B2 | B3 | B4 | B5 |
| Basic Color | Black | — | 0 | 0 | 0 | 0 | 0 | 0 | 0 | 0 | 0 | 0 | 0 | 0 | 0 | 0 | 0 | 0 | 0 | 0 |
| | Blue | — | 0 | 0 | 0 | 0 | 0 | 0 | 0 | 0 | 0 | 0 | 0 | 0 | 1 | 1 | 1 | 1 | 1 | 1 |
| | Green | — | 0 | 0 | 0 | 0 | 0 | 0 | 1 | 1 | 1 | 1 | 1 | 1 | 0 | 0 | 0 | 0 | 0 | 0 |
| | Cyan | — | 0 | 0 | 0 | 0 | 0 | 0 | 1 | 1 | 1 | 1 | 1 | 1 | 1 | 1 | 1 | 1 | 1 | 1 |
| | Red | — | 1 | 1 | 1 | 1 | 1 | 1 | 0 | 0 | 0 | 0 | 0 | 0 | 0 | 0 | 0 | 0 | 0 | 0 |
| | Magenta | — | 1 | 1 | 1 | 1 | 1 | 1 | 0 | 0 | 0 | 0 | 0 | 0 | 1 | 1 | 1 | 1 | 1 | 1 |
| | Yellow | — | 1 | 1 | 1 | 1 | 1 | 1 | 1 | 1 | 1 | 1 | 1 | 1 | 0 | 0 | 0 | 0 | 0 | 0 |
| | White | — | 1 | 1 | 1 | 1 | 1 | 1 | 1 | 1 | 1 | 1 | 1 | 1 | 1 | 1 | 1 | 1 | 1 | 1 |
| Gray Scale of Red | Black | GS0 | 0 | 0 | 0 | 0 | 0 | 0 | 0 | 0 | 0 | 0 | 0 | 0 | 0 | 0 | 0 | 0 | 0 | 0 |
| | ↑ | GS1 | 1 | 0 | 0 | 0 | 0 | 0 | 0 | 0 | 0 | 0 | 0 | 0 | 0 | 0 | 0 | 0 | 0 | 0 |
| | Darker | GS2 | 0 | 1 | 0 | 0 | 0 | 0 | 0 | 0 | 0 | 0 | 0 | 0 | 0 | 0 | 0 | 0 | 0 | 0 |
| | ↑ | ↓ | | | | ↓ | | | | | ↓ | | | | | | ↓ | | | |
| | ↓ | ↓ | | | | ↓ | | | | | ↓ | | | | | | ↓ | | | |
| | Brighter | GS61 | 1 | 0 | 1 | 1 | 1 | 1 | 0 | 0 | 0 | 0 | 0 | 0 | 0 | 0 | 0 | 0 | 0 | 0 |
| | ↓ | GS62 | 0 | 1 | 1 | 1 | 1 | 1 | 0 | 0 | 0 | 0 | 0 | 0 | 0 | 0 | 0 | 0 | 0 | 0 |
| Red | GS63 | 1 | 1 | 1 | 1 | 1 | 1 | 0 | 0 | 0 | 0 | 0 | 0 | 0 | 0 | 0 | 0 | 0 | 0 | |
| Gray Scale of Green | Black | GS0 | 0 | 0 | 0 | 0 | 0 | 0 | 0 | 0 | 0 | 0 | 0 | 0 | 0 | 0 | 0 | 0 | 0 | 0 |
| | ↑ | GS1 | 0 | 0 | 0 | 0 | 0 | 0 | 1 | 0 | 0 | 0 | 0 | 0 | 0 | 0 | 0 | 0 | 0 | 0 |
| | Darker | GS2 | 0 | 0 | 0 | 0 | 0 | 0 | 0 | 1 | 0 | 0 | 0 | 0 | 0 | 0 | 0 | 0 | 0 | 0 |
| | ↑ | ↓ | | | | ↓ | | | | | ↓ | | | | | | ↓ | | | |
| | ↓ | ↓ | | | | ↓ | | | | | ↓ | | | | | | ↓ | | | |
| | Brighter | GS61 | 0 | 0 | 0 | 0 | 0 | 0 | 1 | 0 | 1 | 1 | 1 | 1 | 0 | 0 | 0 | 0 | 0 | 0 |
| | ↓ | GS62 | 0 | 0 | 0 | 0 | 0 | 0 | 0 | 1 | 1 | 1 | 1 | 1 | 0 | 0 | 0 | 0 | 0 | 0 |
| Green | GS63 | 0 | 0 | 0 | 0 | 0 | 0 | 1 | 1 | 1 | 1 | 1 | 1 | 0 | 0 | 0 | 0 | 0 | 0 | |
| Gray Scale of Blue | Black | GS0 | 0 | 0 | 0 | 0 | 0 | 0 | 0 | 0 | 0 | 0 | 0 | 0 | 0 | 0 | 0 | 0 | 0 | 0 |
| | ↑ | GS1 | 0 | 0 | 0 | 0 | 0 | 0 | 0 | 0 | 0 | 0 | 0 | 0 | 1 | 0 | 0 | 0 | 0 | 0 |
| | Darker | GS2 | 0 | 0 | 0 | 0 | 0 | 0 | 0 | 0 | 0 | 0 | 0 | 0 | 0 | 1 | 0 | 0 | 0 | 0 |
| | ↑ | ↓ | | | | ↓ | | | | | ↓ | | | | | | ↓ | | | |
| | ↓ | ↓ | | | | ↓ | | | | | ↓ | | | | | | ↓ | | | |
| | Brighter | GS61 | 0 | 0 | 0 | 0 | 0 | 0 | 0 | 0 | 0 | 0 | 0 | 0 | 1 | 0 | 1 | 1 | 1 | 1 |
| | ↓ | GS62 | 0 | 0 | 0 | 0 | 0 | 0 | 0 | 0 | 0 | 0 | 0 | 0 | 0 | 1 | 1 | 1 | 1 | 1 |
| Blue | GS63 | 0 | 0 | 0 | 0 | 0 | 0 | 0 | 0 | 0 | 0 | 0 | 0 | 1 | 1 | 1 | 1 | 1 | 1 | |

0 : Low level voltage, 1 : High level voltage

Each basic color can be displayed in 64 gray scales from 6 bit data signals. According to the combination of total 18 bit data signals, the 262,144-color display can be achieved on the screen.

9. Optical Characteristics

| Parameter | Symbol | Condition | Min. | Typ. | Max. | Unit | Remark |
|--------------------------|-------------------|------------------------|-------|-------|-------|-------------------|--------------|
| Viewing angle range | Horizontal | $\theta 21, \theta 22$ | 60 | 70 | — | Deg. | [Note 1,3,6] |
| | Vertical | $\theta 11$ | 40 | 50 | — | Deg. | |
| | | $\theta 12$ | 50 | 60 | — | Deg. | |
| Contrast ratio | CRn | $\theta = 0^\circ$ | 450 | — | — | | [Note 2,4,6] |
| | CRo | Optimum viewing angle | 450 | 700 | — | | |
| Response time | $\tau r + \tau d$ | $\theta = 0^\circ$ | — | 30 | 40 | ms | [Note 2,5,6] |
| Chromaticity of white | x | | 0.283 | 0.313 | 0.343 | | [Note 2,6] |
| | y | | 0.299 | 0.329 | 0.359 | | |
| Chromaticity of red | x | | 0.625 | 0.655 | 0.685 | | |
| | y | | 0.301 | 0.331 | 0.361 | | |
| Chromaticity of green | x | | 0.187 | 0.217 | 0.247 | | |
| | y | | 0.650 | 0.680 | 0.710 | | |
| Chromaticity of blue | x | | 0.118 | 0.148 | 0.178 | | |
| | y | | 0.036 | 0.066 | 0.096 | | |
| Color gamut (NTSC ratio) | | | | 90 | | % | |
| Luminance of white | Y_{L1} | | 300 | 375 | — | cd/m ² | |
| White Uniformity | δ_w | | — | 1.20 | 1.45 | | [Note 2,8] |

The measurement shall be executed 30 minutes after lighting at rating. Condition : ($I_L=6.0mArms$)

The optical characteristics shall be measured in a dark room or equivalent.

[Note 1] Optical Characteristics Measurements

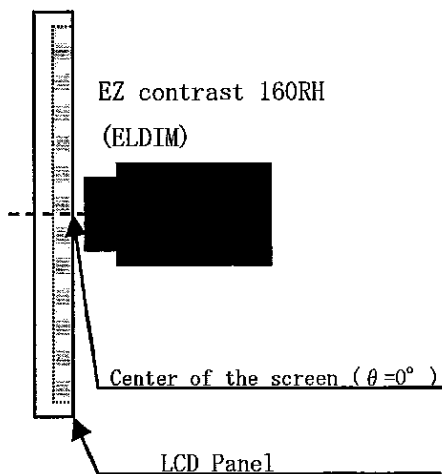

[Note 2] Other Measurements

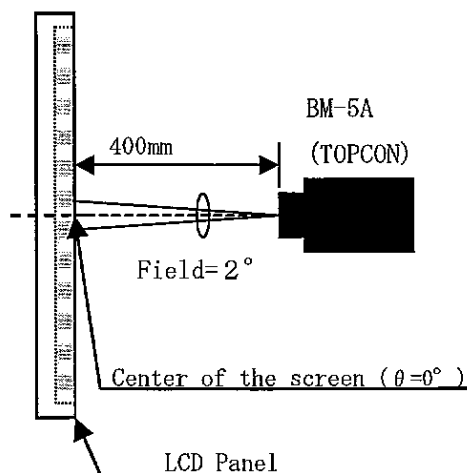

[Note 3] Definitions of viewing angle range:

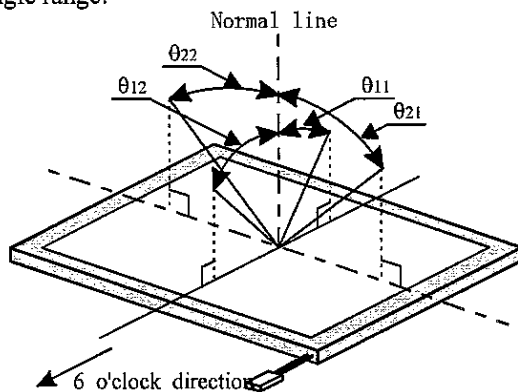

[Note 4] Definition of contrast ratio:

The contrast ratio is defined as the following.

$$\text{Contrast Ratio (CR)} = \frac{\text{Luminance (brightness) with all pixels white}}{\text{Luminance (brightness) with all pixels black}}$$

[Note 5] Definition of response time:

The response time is defined as the following figure and shall be measured by switching the input signal for "black" and "white" .

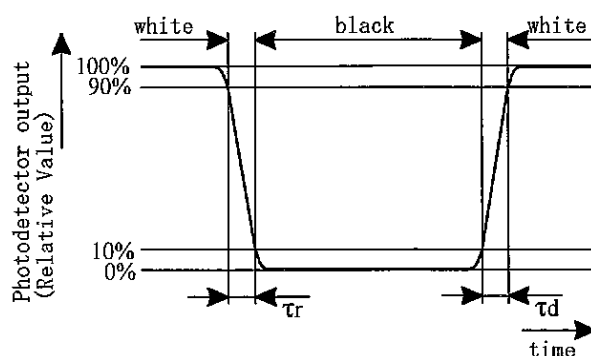

[Note 6] This shall be measured at center of the screen.

[Note 7] Average of five point.(A~E)

[Note 8] Definition of white uniformity:

White uniformity is defined as the following with five measurements (A~E).

$$\delta_w = \frac{\text{Maximum Luminance of five points (brightness)}}{\text{Minimum Luminance of five points (brightness)}}$$

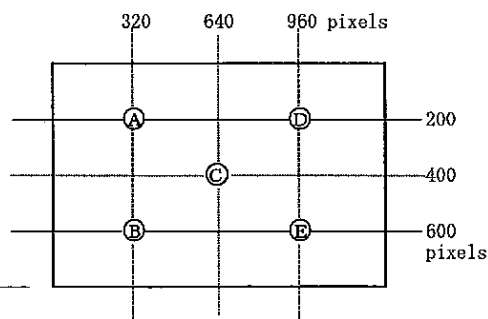

10. Display Quality

The display quality of the color TFT-LCD module shall be in compliance with the Incoming Inspection Standard.

11. Handling Precautions

- a) Be sure to turn off the power supply when inserting or disconnecting the cable.
- b) Be sure to design the cabinet so that the module can be installed without any extra stress such as warp or twist.
- c) Since the front polarizer is easily damaged, pay attention not to scratch it.
Blow away dust on the polarizer with antistatic N₂ blow. It is undesirable to wipe off because a polarizer is sensitive. It is recommended to peel off softly using the adhesive tape when soil or finger oil is stuck to the polarizer. When unavoidable, wipe off carefully with a cloth for wiping lenses.
- d) Wipe off water drop immediately. Long contact with water may cause discoloration or spots.
- e) When the panel surface is soiled, wipe it with absorbent cotton or other soft cloth.
- f) Since the panel is made of glass, it may break or crack if dropped or bumped on hard surface.
Handle with care.
- g) Since CMOS LSI is used in this module, take care of static electricity and injure the human earth when handling. Observe all other precautionary requirements in handling components.
- h) Since there is a circuit board in the module back, stress is not added at the time of a design assembly. Please make it like. If stress is added, there is a possibility that circuit parts may be damaged.
- i) Protection film is attached to the module surface to prevent it from being scratched .
Peel the film off slowly , just before the use, with strict attention to electrostatic charges.
Blow off 'dust' on the polarizer by using an ionized nitrogen.
- j) Do not expose the LCD module to a direct sunlight, for a long period of time to protect the module from the ultra violet ray.
- k) Connect GND of mounting holes to stabilize against EMI and external noise.
- l) When handling LCD modules and assembling them into cabinets, please avoid that long-terms storage in the environment of oxidization or deoxidization gas and the use of such materials as reagent, solvent, adhesive, resin, etc. which generate these gasses, may cause corrosion and discoloration of the modules.
- m) Cold cathode fluorescent lamp in LCD panel contains a small amount of mercury, please follow local ordinances or regulations for disposal.
- n) Be careful of a back light lead not to pull by force at the time of the wiring to an inverter, or line processing.
- o) When install LCD modules in the cabinet, please tighten with "torque = 0.196 N·m(Max).
Be sure to confirm it in the same condition as it is installed in your instrument.
- p) Liquid crystal contained in the panel may leak if the LCD is broken. Rinse it as soon as possible if it gets inside your eye or mouth by mistake.
- q) Notice : Never dismantle the module , because it will cause failure.
Please don't remove the fixed tape, insulating tape etc that was pasted on the original module.
(Except for protection film of the panel and the crepe tape (yellow tape) of fixing lamp cable temporarily.)
- r) Be careful when using it for long time with fixed pattern display as it may cause afterimage.
(Please use a screen saver etc., in order to avoid an afterimage.)
- s) Adjusting volume has been set optimally before shipment, so do not change any adjusted value.
If adjusted value is changed, the specification may not be satisfied.
- t) The lamp used for this product is very sensitive to the temperature.
Luminance decreases rapidly when it is used for a long time or repeatedly under the environment of the low temperature or the module is being cooled.
Please avoid the continuous or repeating use of it under such an environment.
- u) Please handle carefully not to charge excessive stress onto the back of the module.Excessive stress may cause unrepairable damage to the module.

12. Packing form

| | |
|---|-------------------------|
| Piling number of cartons | Max.5 |
| Package quantity in one carton | 10 pcs |
| Carton size | 470(W)×335(D)×313(H) mm |
| Total mass of one carton filled with full modules | 8.6kg |
| Packing form | Fig.1 |

13. Reliability Test Items

| No. | Test item | Conditions |
|-----|---|--|
| 1 | High temperature operation test | Ta = +50°C 48h (Panel-surface temperature is +70°C Max.) |
| 2 | Low temperature operation test | Ta = 0°C 48h |
| 3 | High temperature storage test | Ta = +65°C 48h |
| 4 | Low temperature storage test | Ta = -30°C 48h |
| 5 | High temperature & high humidity operation test | Ta = +45°C ; 90 %RH 48h (No condensation) |
| 6 | High temperature & high humidity storage test | Ta = +50°C ; 90 %RH 48h (No condensation) |
| 7 | Thermal Shock Test (non- operating) | +65°C(2hours) ⇔ -30°C(2hours) 4hours per cycle Temperature change time:10°C/minute Tested for 12 cycles |
| 8 | Shock test (operating) | Max. gravity : 1176 m/s ² (120G) Pulse width : 3 ms, half sine wave Direction : ±X,±Y,±Z once for each direction. |
| 9 | Shock test (non- operating) | Max. gravity : 1764 m/s ² (180G) Pulse width : 3 ms, half sine wave Direction : ±X,±Y,±Z once for each direction. |
| 10 | Vibration test (operating) | Random: Gravity : 10.78 m/s ² rms, 20 minute for each direction of X,Y,Z. Frequency : 5~50Hz: 0.024G ² /Hz : 50~100Hz: -36dB/oct or sine wave: Gravity : 14.7 m/s ² , 20 minute for each direction of X,Y,Z. Frequency : 5~50Hz: 9Hz/min. |
| 11 | Vibration test (non- operating) | Random: Gravity : 22.54 m/s ² rms, 20 minute for each direction of X,Y,Z. Frequency : 5~50Hz: 0.11G ² /Hz : 50~100Hz: -36dB/oct or sine wave: Gravity : 24.5 m/s ² , 20 minute for each direction of X,Y,Z. Frequency : 5~50Hz: 9Hz/min. |
| 12 | ESD test (operating) | Bezel/Panel: IEC 61000-4-2 Air±15kV (LCD module is placed on an insulated board and examined.) |

| | | |
|----|------------------------------|--|
| 13 | ESD test (non- operating) | I/F connector terminal: 200pF 0ohm ±250V (LCD module is placed on an insulated board and examined.) |
| 14 | Hinge cycle simulation | Three-point fixation. ±1040g/10000 cycle (each 4 corners) |
| 15 | Pressure | Screw holes fixed by screw Load to Ipoint from LCD back side Loading area : φ 50mm The gap between LCD front side and plate : 8mm 15kgf 5sec Load point : 4corners and center |
| 16 | Altitude operation test | 70kPa 48hours |
| 17 | Altitude storage test | 26kPa 48hours |

[Result Evaluation Criteria]

Under the display quality test conditions with normal operation state, these shall be no change which may affect practical display function. (normal operation state : Temperature:15~35°C, Humidity:45~75%, Atmospheric pressure:86~106kpa)

14. Label

1) Module Bar code label:

Notation: ①Model No. ②SHARP Logo. ③Manufacture country ④Serial No.

Bar code: ⑤Model No. ⑥Serial No. ⑦Patent No. ⑧RoHS mark

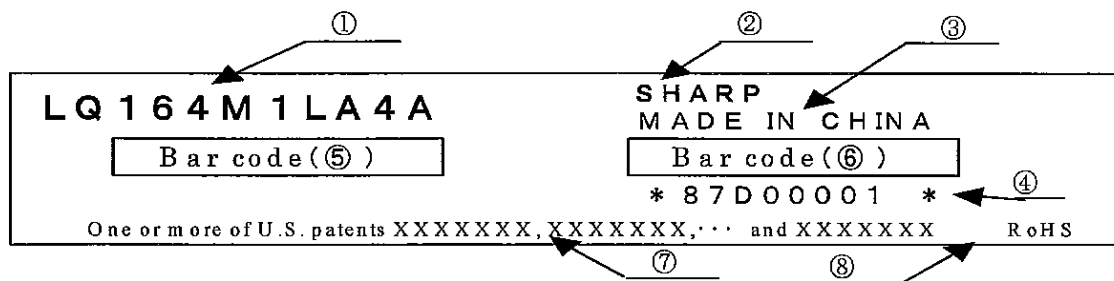

Serial No.

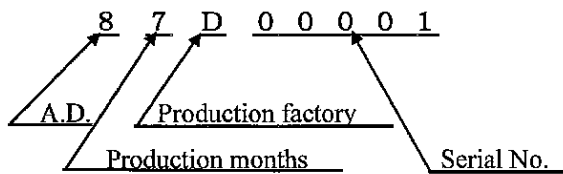

(Production months)

1-9(Jan.-Sep.),X(Oct.),Y(Nov.),Z(Dec)

2) Packing bar code label

Notation/ Bar code: ①Model No. ②Date ③Quantity ④User Part No.

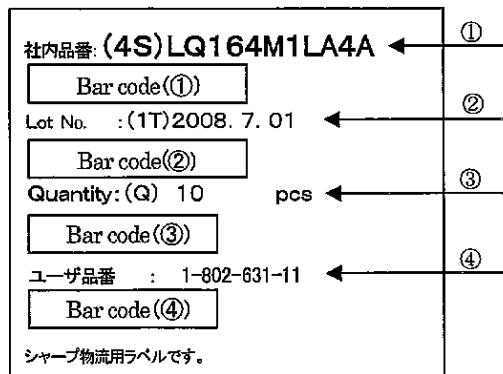

15. RoHS Regulations

This LCD module is compliant with RoHS Directive.

Carton mark

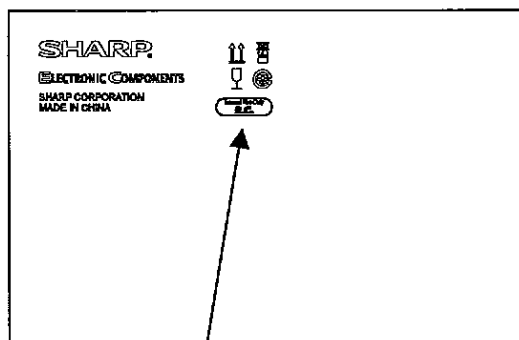

Carton mark (This side)

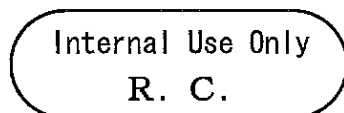

※R.C. (RoHS Compliance) means these parts have corresponded with the RoHS directive.

