

PREPARED BY: _____	DATE _____	SHARP	SPEC No. LD-18321
APPROVED BY: _____	DATE _____		FILE No. _____
			ISSUE: Apr, 11, 2006
			PAGE : 22 pages
		AVC LIQUID CRYSTAL DISPLAY GROUP SHARP CORPORATION SPECIFICATION	APPLICABLE GROUP AVC LIQUID CRYSTAL DISPLAY GROUP

DEVICE SPECIFICATION FOR

TFT - LCD module

MODEL No. LQ255T3LY44A

CUSTOMER'S APPROVAL

DATE _____

BY _____

PRESENTED

BY *K. Tanaka*

K. TANAKA
Department General manager
Development Dept. 1
DEVELOPMENT CENTER
AVC LIQUID CRYSTAL DISPLAY GROUP
SHARP CORPORATION

1. Application

This specification applies to the color 25.5" Wide XGA TFT-LCD module LQ255T3LY44A.

* These specification sheets are proprietary products of SHARP CORPORATION ("SHARP") and include materials protected under copyright of SHARP. Do not reproduce or cause any third party to reproduce them in any form or by any means, electronic or mechanical, for any purpose, in whole or in part, without the express written permission of SHARP.

* In case of using the device for applications such as control and safety equipment for transportation (aircraft, trains, automobiles, etc.), rescue and security equipment and various safety related equipment which require higher reliability and safety, take into consideration that appropriate measures such as fail-safe functions and redundant system design should be taken.

* Do not use the device for equipment that requires an extreme level of reliability, such as aerospace applications, telecommunication equipment (trunk lines), nuclear power control equipment and medical or other equipment for life support.

* SHARP assumes no responsibility for any damage resulting from the use of the device that does not comply with the instructions and the precautions specified in these specification sheets.

* Contact and consult with a SHARP sales representative for any questions about this device.

2. Overview

This module is a color active matrix LCD module incorporating amorphous silicon TFT (Thin Film Transistor). It is composed of a color TFT-LCD panel, driver ICs, control circuit, power supply circuit, inverter circuit and back light system etc. Graphics and texts can be displayed on a 1366 × RGB × 768 dots panel with 16,777,216 colors by using LVDS (Low Voltage Differential Signaling) to interface, +5V of DC supply voltages.

This module also includes the DC/AC inverter to drive the CCFT. (+24V of DC supply voltage)

And in order to improve the response time of LCD, this module applies the Over Shoot driving (O/S driving) technology for the control circuit. In the O/S driving technology, signals are being applied to the Liquid Crystal according to a pre-fixed process as an image signal of the present frame when a difference is found between image signal of the previous frame and that of the current frame after comparing them.

By using the captioned process, the image signals of this LCD module are being set so that image response can be completed within one frame, as a result, image blur can be improved and clear image performance can be realized.

3. Mechanical Specifications

Parameter	Specifications	Unit
Display size	64.8 (Diagonal)	cm
	25.5 (Diagonal)	inch
Active area	564.8 (H) x 317.6 (V)	mm
Pixel Format	1366 (H) x 768 (V) (1pixel = R + G + B dot)	pixel
Pixel pitch	0.4135(H) x 0.4135 (V)	mm
Pixel configuration	R, G, B vertical stripe	
Display mode	Normally black	
Unit Outline Dimensions (*1)	626.0(W) x 373.0(H) x 48.0(D)	mm
Mass	5.3 ± 0.3	kg
Surface treatment	glare, low reflection coating Hard coating: 2H	

(*1) Outline dimensions are shown in Fig.1

4. Input Terminals

4-1. TFT panel driving

CN1 (Interface signals and +5V DC power supply) (Shown in Fig.1)

Using connector : FI-X30SSL-HF (Japan Aviation Electronics Ind. , Ltd.) or equivalent

Mating connector : FI-X30H/FI-X30HL, FI-X30C/FI-X30C2L

or FI-X30M (Japan Aviation Electronics Ind. , Ltd.)

Mating LVDS transmitter : THC63LVDM83A or equivalent device

Pin No.	Symbol	Function	Remark
1	VCC	+5V Power Supply	
2	VCC	+5V Power Supply	
3	VCC	+5V Power Supply	
4	VCC	+5V Power Supply	
5	GND	GND	
6	GND	GND	
7	GND	GND	
8	GND	GND	
9	SELLVDS	Select LVDS data order 【Note 1】	Pull up Default H:3.3V 【Note 3】
10	NC		
11	GND	Ground	
12	RIN0-	Negative (-) LVDS differential data input	LVDS
13	RIN0+	Positive (+) LVDS differential data input	LVDS
14	GND	Ground	
15	RIN1-	Negative (-) LVDS differential data input	LVDS
16	RIN1+	Positive (+) LVDS differential data input	LVDS
17	GND	Ground	
18	RIN2-	Negative (-) LVDS differential data input	LVDS
19	RIN2+	Positive (+) LVDS differential data input	LVDS
20	GND	Ground	
21	CLKIN-	Clock Signal(-)	LVDS
22	CLKIN+	Clock Signal(+)	LVDS
23	GND	Ground	
24	RIN3-	Negative (-) LVDS differential data input	LVDS
25	RIN3+	Positive (+) LVDS differential data input	LVDS
26	GND	Ground	
27	R/L	Horizontal shift direction 【Note 2】	Pull down Default L:GND 【Note 4】
28	U/D	Vertical shift direction 【Note 2】	Pull down Default L:GND 【Note 4】
29	Reserved	Not Available	
30	Reserved	Not Available	

【note】 GND of a liquid crystal panel drive part has connected with a module chassis.

【Note1】SELLVDS

Transmitter		SELLVDS	
Pin No	Data	=L(GND)	=H(3.3V) or Open
51	TA0	R0(LSB)	R2
52	TA1	R1	R3
54	TA2	R2	R4
55	TA3	R3	R5
56	TA4	R4	R6
3	TA5	R5	R7(MSB)
4	TA6	G0(LSB)	G2
6	TB0	G1	G3
7	TB1	G2	G4
11	TB2	G3	G5
12	TB3	G4	G6
14	TB4	G5	G7(MSB)
15	TB5	B0(LSB)	B2
19	TB6	B1	B3
20	TC0	B2	B4
22	TC1	B3	B5
23	TC2	B4	B6
24	TC3	B5	B7(MSB)
27	TC4	NA	NA
28	TC5	NA	NA
30	TC6	DE(*)	DE(*)
50	TD0	R6	R0(LSB)
2	TD1	R7(MSB)	R1
8	TD2	G6	G0(LSB)
10	TD3	G7(MSB)	G1
16	TD4	B6	B0(LSB)
18	TD5	B7(MSB)	B1
25	TD6	NA	NA

NA: Not Available

(*) Since the display position is prescribed by the rise of DE (Display Enable) signal, please do not fix DE signal during operation at "High."

【Note 2】 Display reversal function

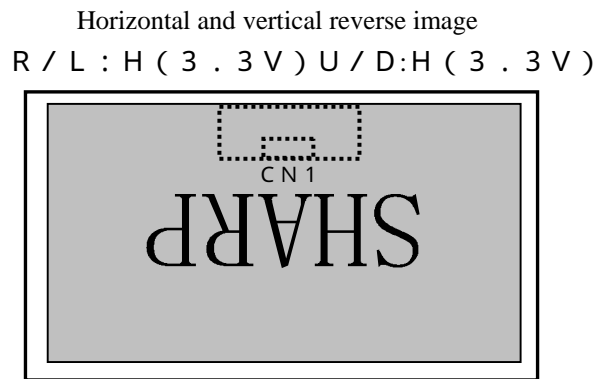
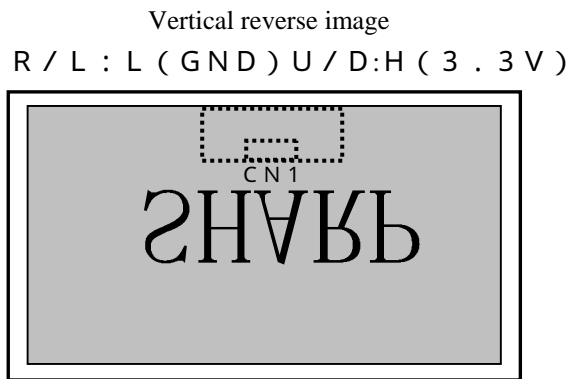
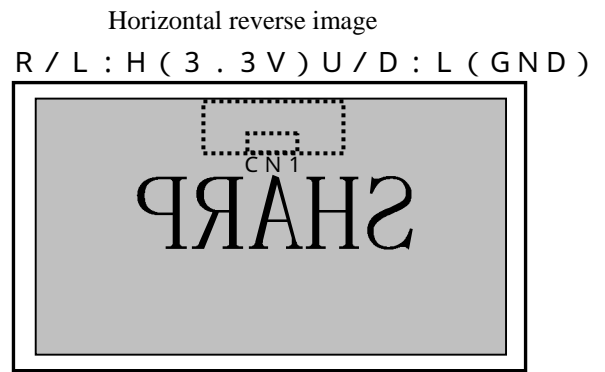
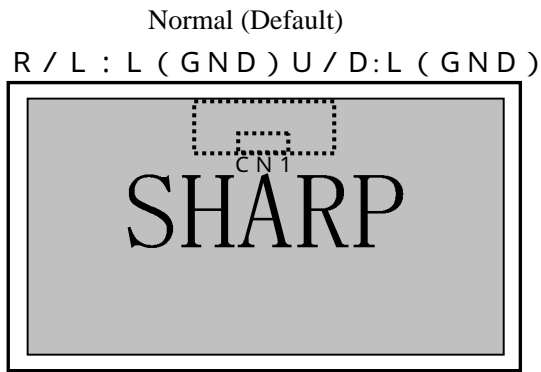

【Note 3】 The equivalent circuit figure of the terminal

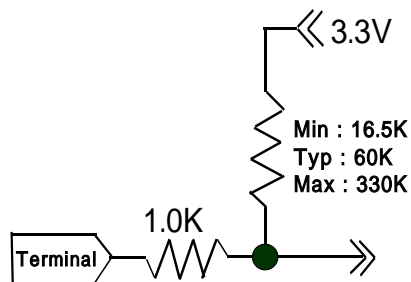

【Note 4】 The equivalent circuit figure of the terminal

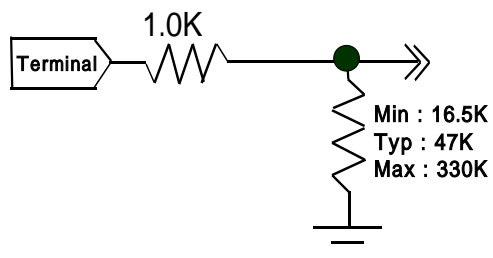

• Interface block diagram

Corresponding Transmitter: THC63LVDM83R (THine) or equivalent device

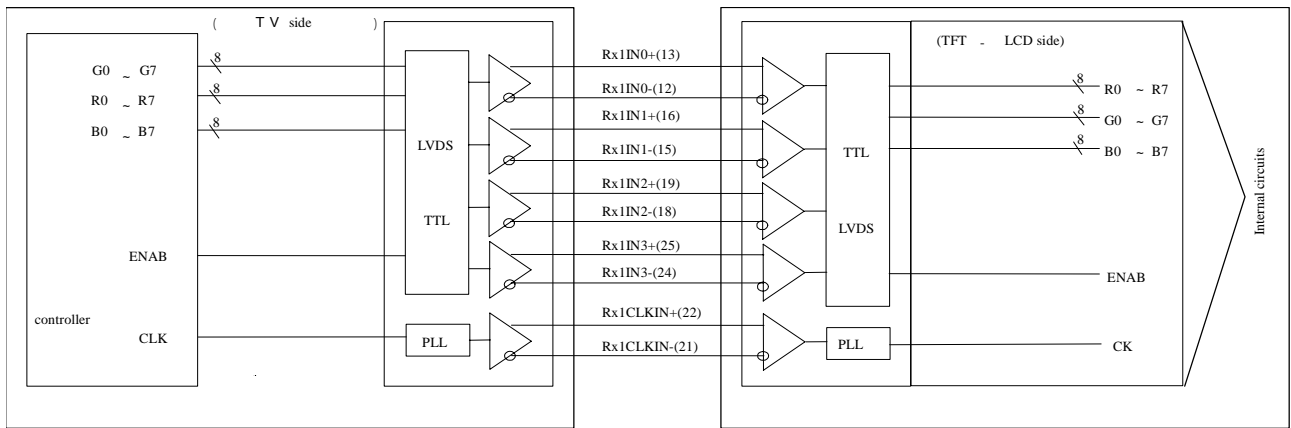

• Block Diagram (LCD Module)

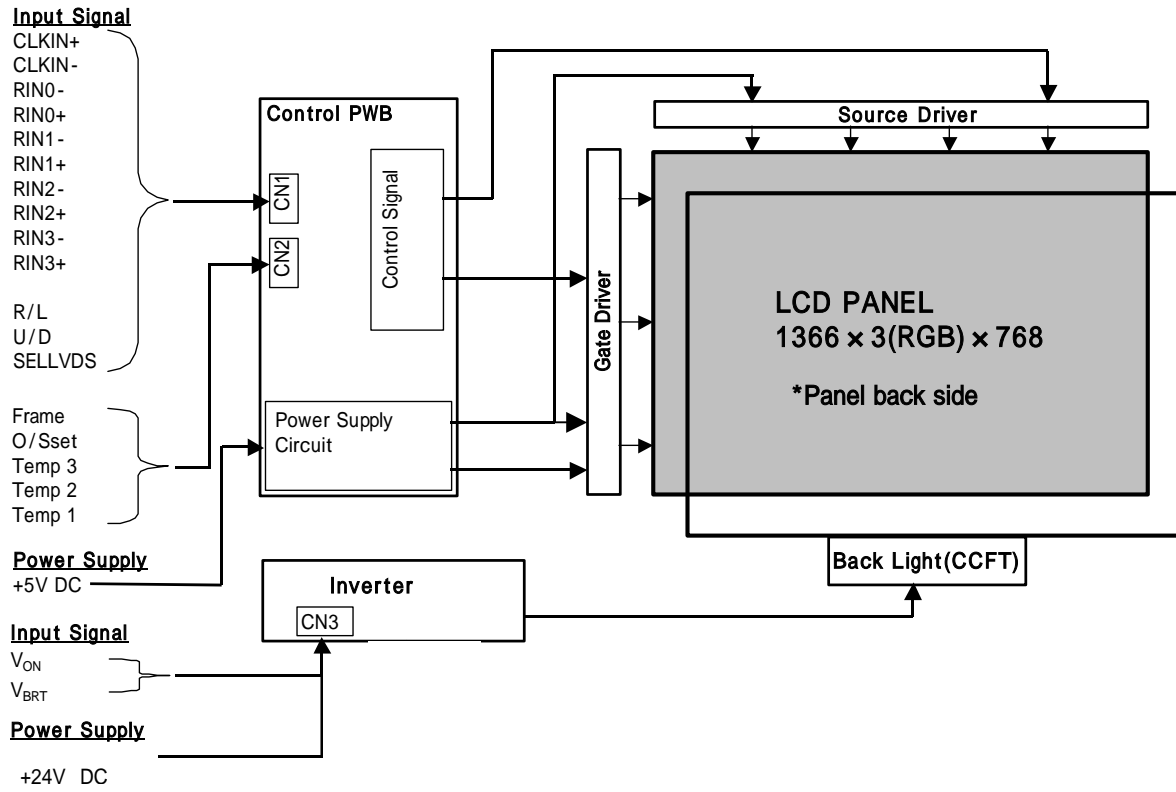

SELLVDS= High (3.3V) or Open

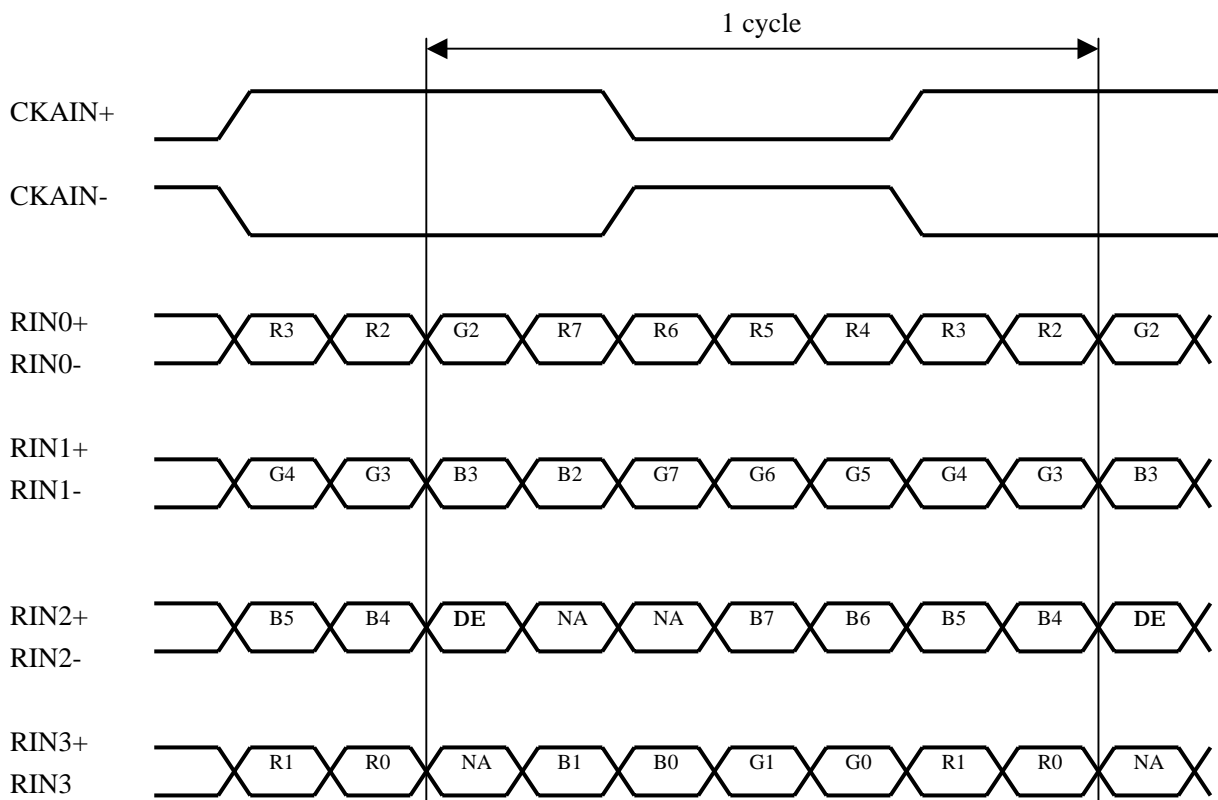

SELLVDS= Low(GND)

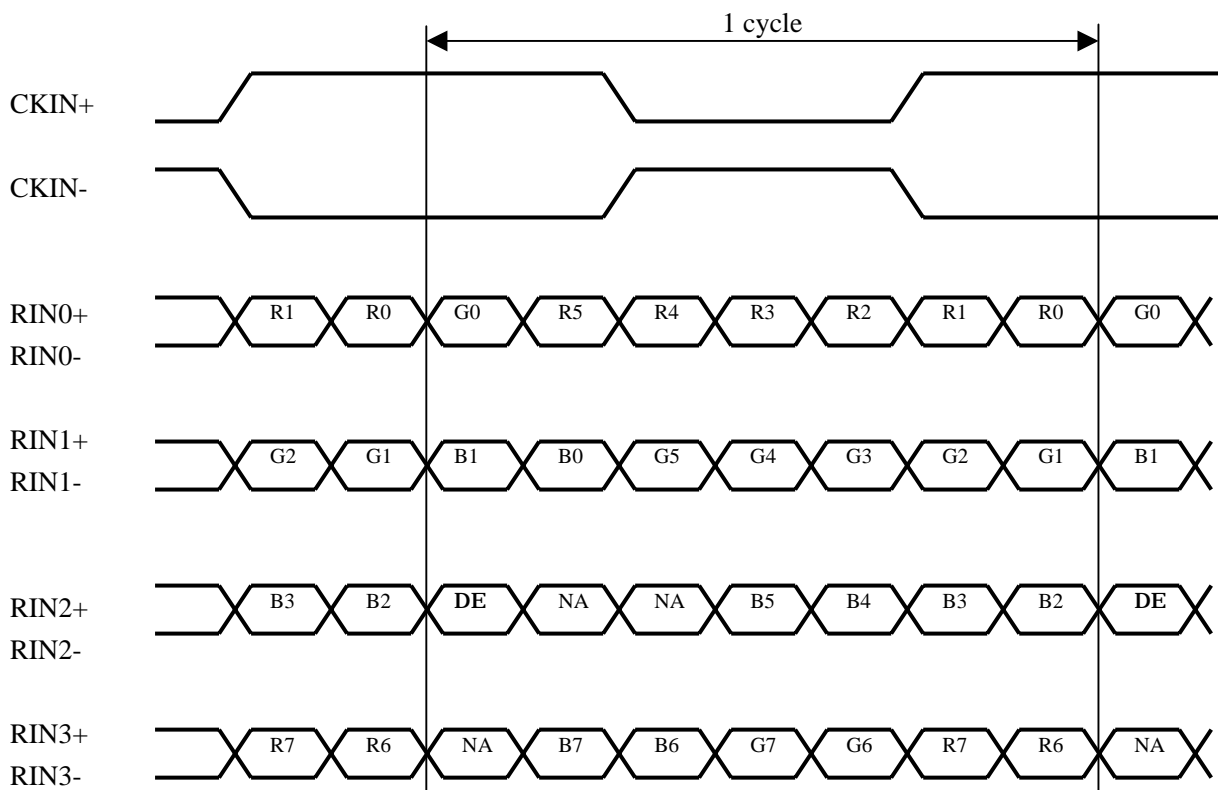

DE: Display Enable

NA: Not Available (Fixed Low)

CN2 (O/S control) (Shown Fig 1)

O/S Driving Pin No and function

Using connector : SM07B-SRSS-TB-A (JST)

Mating connector : SHR-07V-S or SHR-07V-S-B (JST)

Pin No.	Symbol	Function	Default	Remark
1	Frame	Frame frequency setting H:60Hz, L:50Hz	Pull up H:3.3V	【Note 2】
2	O/S set	O/S operation setting H:O/S_ON, L:O/S_OFF	Pull up H:3.3V 【Note 1】	【Note 2】
3	TEST	Fix to Low level usually.	Pull down L:GND	【Note 3】
4	Temp3	Data3 of panel surface temperature	Pull up H:3.3V	【Note 2】
5	Temp2	Data2 of panel surface temperature	Pull up H:3.3V	【Note 2】
6	Temp1	Data1 of panel surface temperature	Pull up H:3.3V	【Note 2】
7	GND	GND		

*L: Low level voltage (GND) H: High level voltage(3.3V)

【Note 1】 In case of O/S set setting "L"(O/S_OFF), it should be set the "Temp1~3" and "Frame" to "L".

【Note 2】The equivalent circuit figure of the terminal

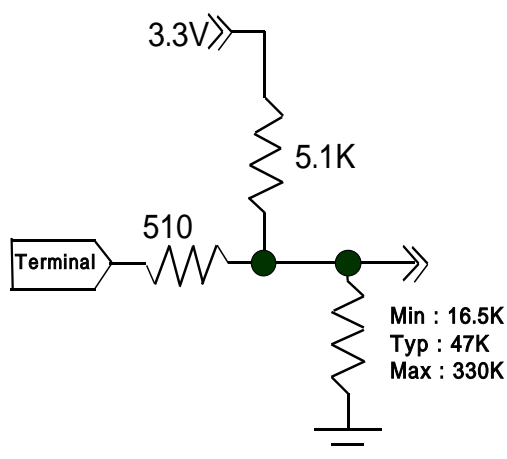

【Note 3】The equivalent circuit figure of the terminal

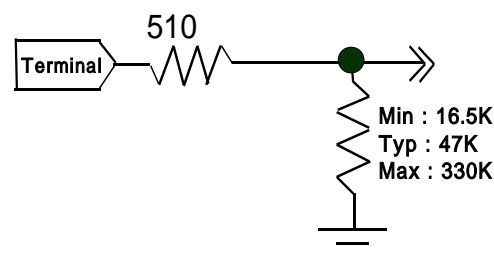

According as the surface temperature of the panel, enter the optimum 3 bit signal into pin No.4,5,6.

Measuring the correlation between detected temperature by the sensor on PWB in users side and actual surface temperature of panel at center, convert the temperature detected by the sensor to the surface temperature of panel to enter the 3 bit temperature data.

Pin no.	Surface temperature of panel							
	0-5	5-10	10-15	15-20	20-25	25-30	30-35	35 and above
4	L	L	L	L	H	H	H	H
5	L	L	H	H	L	L	H	H
6	L	H	L	H	L	H	L	H

*L: Low level voltage (GND) H: High level voltage(3.3V)

*For overlapping temperatures (such as 5 ,10 ,15 ,20 ,25 , 30 ,35) select the optimum parameter, judging from the actual picture image.

4-2. Backlight driving

CN3 (Inverter control)

Using connector: B14B-PH-SM3-TB(JST)

Mating connector: PHR-14 (JST)

Pin No.	Symbol	Function	Remark
1	V _{INV}	+24V	
2	V _{INV}	+24V	
3	V _{INV}	+24V	
4	V _{INV}	+24V	
5	V _{INV}	+24V	
6	GND	GND	
7	GND	GND	
8	GND	GND	
9	GND	GND	
10	GND	GND	
11	Reserved	NC	
12	V _{ON}	Inverter ON/OFF	【Note 1】
13	V _{BRT}	Brightness Control	【Note 2】
14	Reserved	NC	

【Note 1】 Inverter ON/OFF

Input voltage	Function
5V	Inverter: ON
0V	Inverter: OFF

【Note 2】 Brightness Control

PWM Brightness Control is regulated by analog input voltage (0V to 3.3V) .

Input voltage	Function
0V	Brightness Control : (Dark)
3.3V	Brightness Control : (Bright)

4-3. The back light system characteristics

The back light system is direct type with 7 CCFTs (Cold Cathode Fluorescent Tube).

The characteristics of the lamp are shown in the following table.

The value mentioned below is at the case of one CCFT.

Item	Symbol	Min.	Typ.	Max.	Unit	Remarks
Life time	T _L	60000	-	-	Hour	【Note】

【Note】• Lamp life time is defined as the time when brightness becomes 50% of the original value in the continuous operation under the condition of Ta=25 and brightness control(V_{BRT}=3.3V).

- This definition is valid with the condition that the module is placed horizontally. (The wide side of the module should be parallel to the ground.)

5. Absolute Maximum Ratings

Parameter	Symbol	Condition	Ratings	Unit	Remark
Input voltage (for Control)	V _I	Ta=25	-0.3 ~ 5.0	V	【Note 1】
5V supply voltage (for Control)	VCC	Ta=25	0 ~ + 6	V	
Input voltage (for Inverter)	V _{BRT} V _{ON}	Ta=25	0 ~ + 6	V	
24V supply voltage (for Inverter)	V _{INV}	Ta=25	0 ~ +29	V	
Storage temperature	Tstg	-	-25 ~ +60		【Note 2】
Operation temperature (Ambient)	Topa	-	0 ~ +50		

【Note 1】 SELLVDS, R/L, U/D,TEST, Frame, O/S set, Temp1, Temp2, Temp3

【Note 2】 Humidity 95%RH Max.(Ta 40)

Maximum wet-bulb temperature at 39 or less.(Ta>40)

No condensation.

6. Electrical Characteristics

6-1. Control circuit driving

Ta=25

Parameter		Symbol	Min.	Typ.	Max.	Unit	Remark
+5V supply voltage	Supply voltage	V _{CC}	+4.5	+5.0	+5.5	V	【Note 1】
	Current dissipation	I _{CC}	-	700	1600	mA	【Note 2】
Permissible input ripple voltage		V _{RP}	-	-	100	mV _{P-P}	V _{CC} = +5.0V
Differential input threshold voltage	High	V _{TH}	-	-	100	mV	V _{CM} = +1.2V 【Note 6】
	Low	V _{TL}	-100	-	-	mV	
Input Low voltage		V _{IL}	-	-	0.7	V	【Note 3】
Input High voltage		V _{IH}	2.6	3.3	3.6	V	
Input leak current (Low)		I _{IL1}	-	-	100	μA	V _I = 0V 【Note 4】
		I _{IL2}	-	-	400	μA	V _I = 0V 【Note 5】
Input leak current (High)		I _{IH1}	-	-	100	μA	V _I = 3.3V 【Note 4】
		I _{IH2}	-	-	400	μA	V _I = 3.3V 【Note 5】
Terminal resistor		R _T	-	100	-		Differential input

【Note】 V_{CM}: Common mode voltage of LVDS driver.

【Note 1】

Input voltage sequences

$$0 < t_1 \quad 10\text{ms}$$

$$10\text{ms} \quad t_{2-1} \quad 20\text{m}$$

$$t_{2-2} \quad 10\text{ms}$$

$$0 < t_3 \quad 1\text{s}$$

$$t_4 \quad 1\text{s}$$

$$t_5 \quad 200\text{ms}$$

Dip conditions for supply voltage

$$\text{a) } 2.7\text{V} \quad V_{CC} < 4.5\text{V}$$

$$t_d \quad 10\text{ms}$$

$$\text{b) } V_{CC} < 2.7\text{V}$$

Dip conditions for supply voltage is based on input voltage sequence.

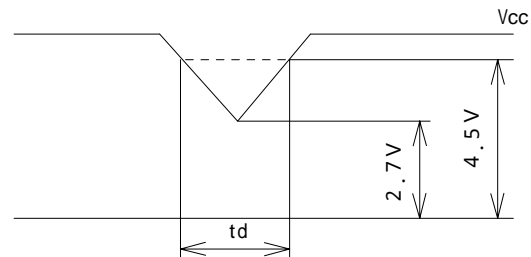
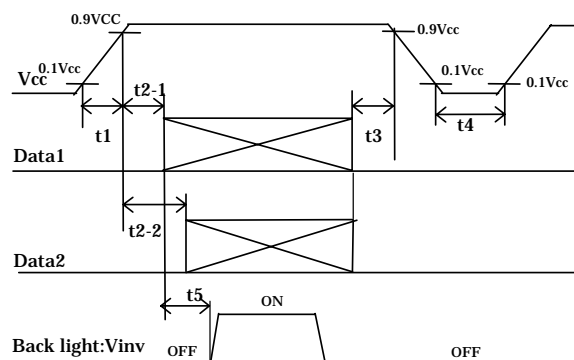

Data1: CLKIN ±, RIN0 ±, RIN1 ±, RIN2 ±, RIN3 ±

Data2: R/L, U/D, SELLVDS, Frame, O/Sset, Temp1, 2, 3

About the relation between data input and back light lighting, please base on the above-mentioned input sequence.

When back light is switched on before panel operation or after a panel operation stop, it may not display normally. But this phenomenon is not based on change of an incoming signal, and does not give damage to a liquid crystal display.

【Note 2】 Typical current situation: 256 gray-bar pattern (Vcc = +5.0V)

The explanation of RGB gray scale is seen in section 8.

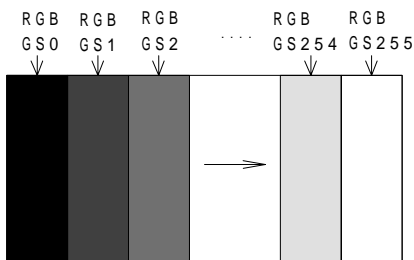

Vcc = 5.0V
 CK = 82.0MHz
 Th = 20.67 μs

【Note 3】 R/L, U/D, SELLVDS, TEST, Frame, O/S set, Temp1, Temp2, Temp3

【Note 4】 R/L, U/D

【Note 5】 SELLVDS, TEST, Frame, O/S set, Temp1, Temp2, Temp3

【Note 6】 CLKIN+/CLKIN-, RIN0+/RIN0-, RIN1+/RIN1-, RIN2+/RIN2-, RIN3+/RIN3-,

6-2. Inverter driving for back light

The back light system is direct type with 7 CCFTs (Cold Cathode Fluorescent Tube).

Ta=25

Parameter	Symbol	Min.	Typ.	Max.	Unit	Remark	
+ 24V	Current dissipation	I _{INV}	-	3.1	4.4	A	V _{INV} = 24V V _{BRT} = 3.3V, V _{ON} =5V 【Note 1】
	Supply voltage	V _{INV}	22.5	24.0	25.5	V	
Permissible input ripple voltage	V _{RF}	-	-	1000	mV _{p-p}	V _{INV} = 24V	
Input voltage (Low)	V _{ONL}	0	-	1.0	V	Von impedance=8.2k	
Input voltage (High)	V _{ONH}	3.0	5.0	6.0	V		
Brightness control voltage	V _{BRT}	0		3.3	V	V _{BRT} impedance=100k	

【Note 1】 1)V_{INV}-turn-on condition

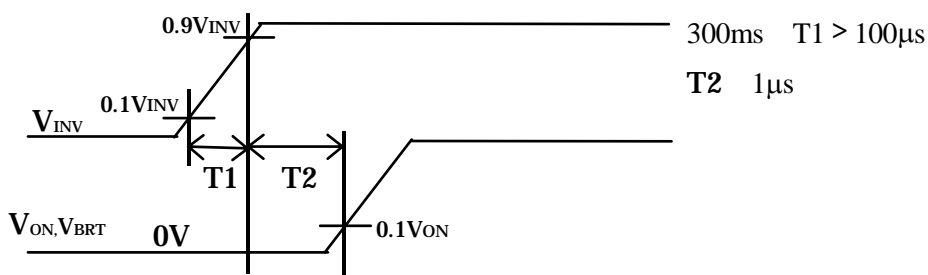

2) V_{INV}-turn-off condition

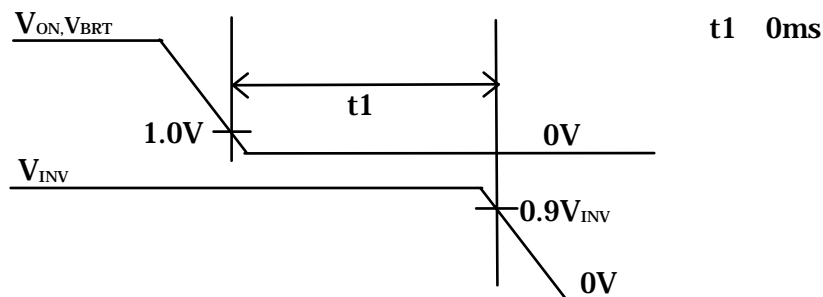

7. Timing characteristics of input signals

7-1. Timing characteristics

Timing diagrams of input signal are shown in Fig.2

Parameter		Symbol	Min.	Typ.	Max.	Unit	Remark
Clock	Frequency	1/Tc	65	82	85	MHz	【Note1】
Data enable signal	Horizontal period	TH	1560	1696	1940	clock	【Note1】
	Horizontal period (High) time	THt	18.35	20.67	-	μs	【Note1】
	Horizontal period (High)	THd	1366	1366	1366	clock	
	Vertical period	TV	778	806	972	line	
	Vertical period (High)	TVd	768	768	768	line	

【Note】 When vertical period is very long, flicker and etc. may occur.

As for the acceptable value of vertical period, it should be discussed and determined between both parties.

Please turn off the module after it shows the black screen.

Please make sure that length of vertical period should become of an integral multiple of horizontal length of period. Otherwise, the screen may not display properly.

【Note1】 Set up clock frequency and horizontal period to be less low than the min value of horizontal period time.

As for the your final setting of driving timing, we will conduct operation check test at our side, please inform your final setting.

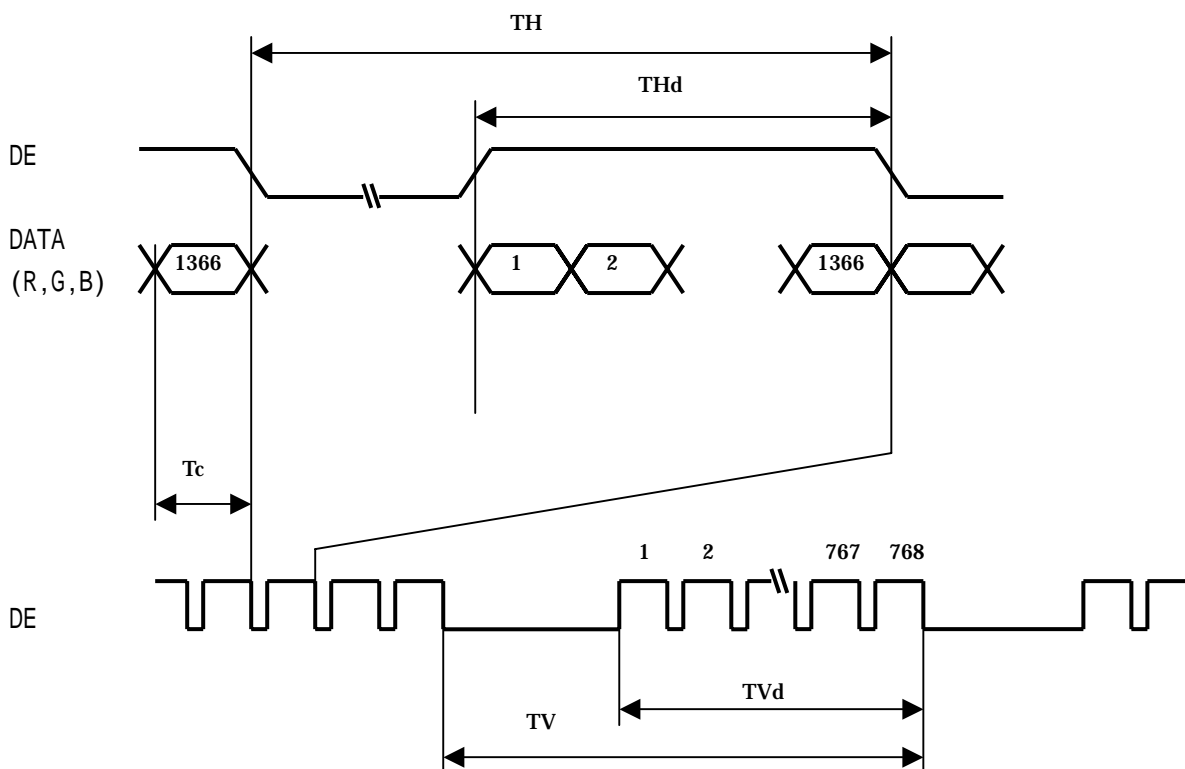
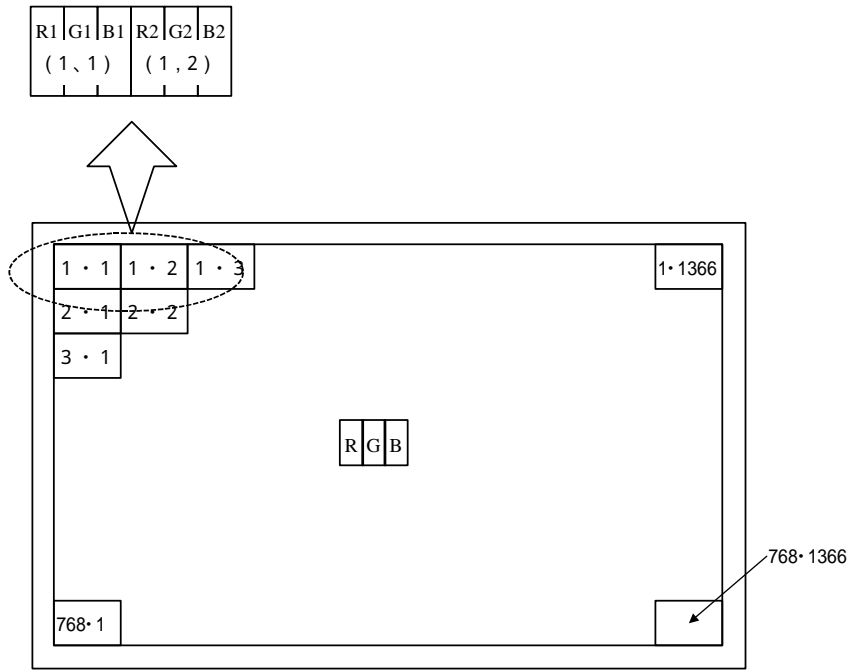

Fig.2 Timing characteristics of input signals

7-2. Input data signal and display position on the screen



Display Position of Data (V,H)

8. Input Signal, Basic Display Colors and Gray Scale of Each Color

	Colors & Gray scale	Data signal																								
		Gray Scale	R0	R1	R2	R3	R4	R5	R6	R7	G0	G1	G2	G3	G4	G5	G6	G7	B0	B1	B2	B3	B4	B5	B6	B7
Basic Color	Black	-	0	0	0	0	0	0	0	0	0	0	0	0	0	0	0	0	0	0	0	0	0	0	0	0
	Blue	-	0	0	0	0	0	0	0	0	0	0	0	0	0	0	0	0	1	1	1	1	1	1	1	1
	Green	-	0	0	0	0	0	0	0	0	1	1	1	1	1	1	1	1	0	0	0	0	0	0	0	0
	Cyan	-	0	0	0	0	0	0	0	0	1	1	1	1	1	1	1	1	1	1	1	1	1	1	1	1
	Red	-	1	1	1	1	1	1	1	1	0	0	0	0	0	0	0	0	0	0	0	0	0	0	0	0
	Magenta	-	1	1	1	1	1	1	1	1	0	0	0	0	0	0	0	0	1	1	1	1	1	1	1	1
	Yellow	-	1	1	1	1	1	1	1	1	1	1	1	1	1	1	1	1	0	0	0	0	0	0	0	0
	White	-	1	1	1	1	1	1	1	1	1	1	1	1	1	1	1	1	1	1	1	1	1	1	1	1
Gray Scale of Red	Black	GS0	0	0	0	0	0	0	0	0	0	0	0	0	0	0	0	0	0	0	0	0	0	0	0	0
	↑	GS1	1	0	0	0	0	0	0	0	0	0	0	0	0	0	0	0	0	0	0	0	0	0	0	0
	Darker	GS2	0	1	0	0	0	0	0	0	0	0	0	0	0	0	0	0	0	0	0	0	0	0	0	0
	↑	↓					↓							↓								↓				
	↓	↓					↓							↓								↓				
	Brighter	GS253	1	0	1	1	1	1	1	1	0	0	0	0	0	0	0	0	0	0	0	0	0	0	0	0
	↓	GS254	0	1	1	1	1	1	1	1	0	0	0	0	0	0	0	0	0	0	0	0	0	0	0	0
	Red	GS255	1	1	1	1	1	1	1	1	0	0	0	0	0	0	0	0	0	0	0	0	0	0	0	0
Gray Scale of Green	Black	GS0	0	0	0	0	0	0	0	0	0	0	0	0	0	0	0	0	0	0	0	0	0	0	0	0
	↑	GS1	0	0	0	0	0	0	0	0	1	0	0	0	0	0	0	0	0	0	0	0	0	0	0	0
	Darker	GS2	0	0	0	0	0	0	0	0	0	1	0	0	0	0	0	0	0	0	0	0	0	0	0	0
	↑	↓					↓							↓								↓				
	↓	↓					↓							↓								↓				
	Brighter	GS253	0	0	0	0	0	0	0	0	1	0	1	1	1	1	1	1	0	0	0	0	0	0	0	0
	↓	GS254	0	0	0	0	0	0	0	0	0	1	1	1	1	1	1	1	0	0	0	0	0	0	0	0
	Green	GS255	0	0	0	0	0	0	0	0	1	1	1	1	1	1	1	1	0	0	0	0	0	0	0	0
Gray Scale of Blue	Black	GS0	0	0	0	0	0	0	0	0	0	0	0	0	0	0	0	0	0	0	0	0	0	0	0	0
	↑	GS1	0	0	0	0	0	0	0	0	0	0	0	0	0	0	0	0	1	0	0	0	0	0	0	0
	Darker	GS2	0	0	0	0	0	0	0	0	0	0	0	0	0	0	0	0	0	1	0	0	0	0	0	0
	↑	↓					↓							↓								↓				
	↓	↓					↓							↓								↓				
	Brighter	GS253	0	0	0	0	0	0	0	0	0	0	0	0	0	0	0	0	1	0	1	1	1	1	1	1
	↓	GS254	0	0	0	0	0	0	0	0	0	0	0	0	0	0	0	0	0	1	1	1	1	1	1	1
	Blue	GS255	0	0	0	0	0	0	0	0	0	0	0	0	0	0	0	0	1	1	1	1	1	1	1	1

0 : Low level voltage, 1 : High level voltage.

Each basic color can be displayed in 256 gray scales from 8 bit data signals. According to the combination of total 24 bit data signals, the 16-million-color display can be achieved on the screen.

9. Optical characteristics

$T_a=25$, $V_{CC} = +5V$, $V_{INV} = +24V$

Parameter	Symbol	Condition	Min.	Typ.	Max.	Unit	Remark
Viewing angle range	Horizontal	CR 10	70	88	-	Deg.	【Note1,4】
	Vertical		70	88	-	Deg.	
Contrast ratio	CRn	=0 deg.	900	1200	-		【Note2,4】 $V_{BRT}=3.3V$
Response time	τ_d	=0 deg.	-	6	-	ms	【Note3,4,5】 $V_{BRT}=3.3V$
	τ_r		-	6	-		
Chromaticity of white	X		0.246	0.276	0.306	-	【Note 4】 $V_{BRT}=3.3V$
	Y		0.252	0.282	0.312	-	
Chromaticity of red	X		0.610	0.640	0.670	-	
	Y		0.300	0.330	0.360	-	
Chromaticity of green	X		0.250	0.280	0.310	-	
	Y		0.570	0.600	0.630	-	
Chromaticity of blue	X		0.120	0.150	0.180	-	
	Y		0.030	0.060	0.090	-	
Luminance of white	Y_{L1}		400	500		cd/m ²	【Note 4】 $V_{BRT}=3.3V$
Luminance uniformity	w		-	-	1.25		【Note 6】

Measurement condition : Set the value of V_{BRT} to maximum luminance of white.

*The measurement shall be executed 60 minutes after lighting at rating.

【Note】 The optical characteristics are measured using the following equipment.

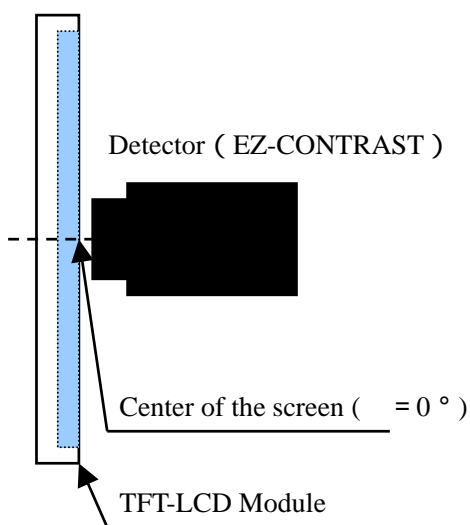

Fig.3-1 Measurement of viewing angle range.

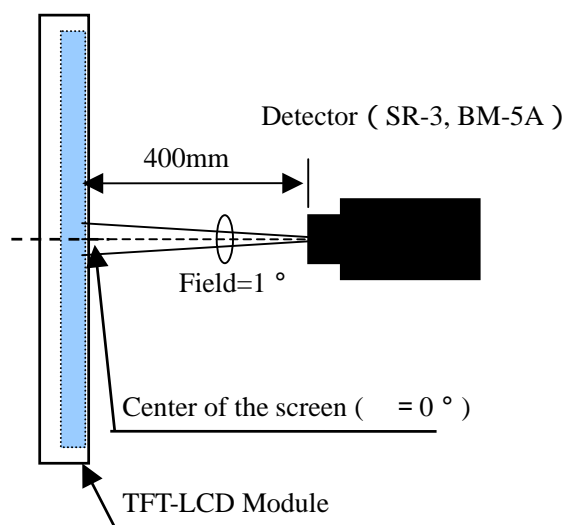
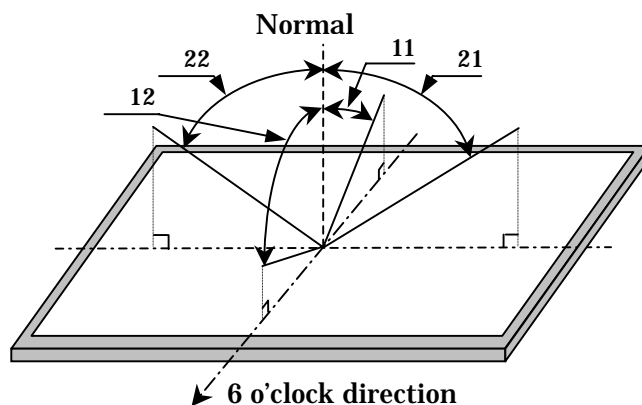

Fig.3-2 Measurement of Contrast, Luminance, Chromaticity and Response time.
(Contrast, Luminance and Chromaticity: SR-3, Response time: Photo Diode).

【Note 1】 Definitions of viewing angle range :



【Note 2】 Definition of contrast ratio :

The contrast ratio is defined as the following.

$$\text{Contrast Ratio} = \frac{\text{Luminance (brightness) with all pixels white}}{\text{Luminance (brightness) with all pixels black}}$$

【Note 3】 Definition of response time

The response time (τd and τr) is defined as the following figure and shall be measured by switching the input signal for “any level of gray (0%, 25%, 50%, 75% and 100%)” and “any level of gray (0%, 25%, 50%, 75% and 100%)”.

	0%	25%	50%	75%	100%
0%		tr:0%-25%	tr:0%-50%	tr:0%-75%	tr:0%-100%
25%	td: 25%-0%		tr: 25%-50%	Tr25%-75%	tr: 25%-100%
50%	td: 50%-0%	td: 50%-25%		tr: 50%-75%	tr: 50%-100%
75%	td: 75%-0%	td: 75%-25%	td: 75%-50%		tr: 75%-100%
100%	td: 100%-0%	td: 100%-25%	td: 100%-50%	td: 100%-75%	

$t^*:x-y$...response time from level of gray(x) to level of gray(y)

$$\tau r = \Sigma(tr:x-y)/10, \tau d = \Sigma(td:x-y)/10$$

【Note 4】 This shall be measured at center of the screen.

【Note 5】 This value is valid when O/S driving is used at typical input time value .

【Note 6】 Definition of white uniformity ;

White uniformity is defined as the following with five measurements. (A ~ E)

$$w = \frac{\text{Maximum luminance of five points (brightness)}}{\text{Minimum luminance of five points (brightness)}}$$

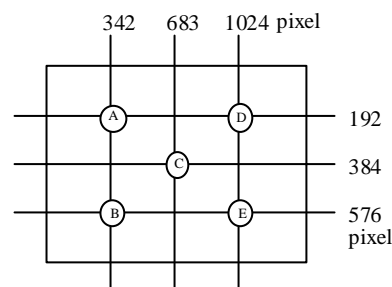

10. Handling Precautions of the module

- a) Be sure to turn off the power supply when inserting or disconnecting the cable.
- b) This product is using the parts (inverter, CCFT etc), which generate the high voltage.
Therefore, during operating, please don't touch these parts.

- c) Brightness control voltage is switched for "ON" and "OFF", as shown in Fig.4. Voltage difference generated by this switching, V_{INV} , may affect a sound output, etc. when the power supply is shared between the inverter and its surrounding circuit. So, separate the power supply of the inverter circuit with the one of its surrounding circuit.

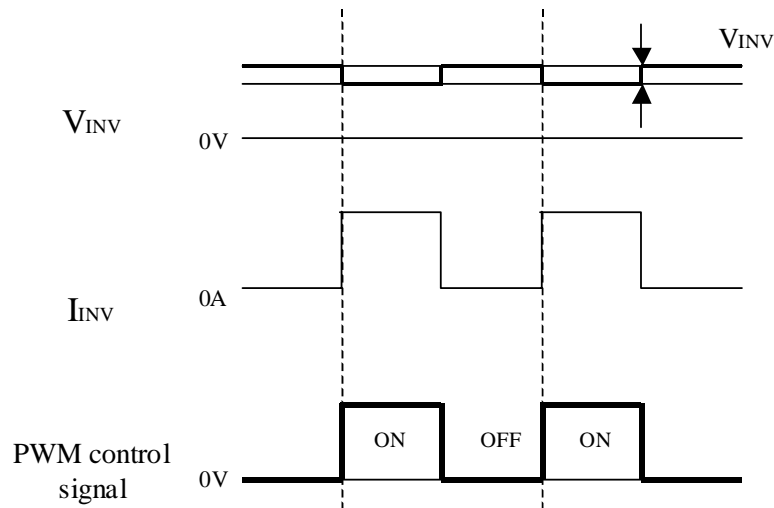

Fig.4 Brightness control voltage.

- d) Be sure to design the cabinet so that the module can be installed without any extra stress such as warp or twist.
- e) Since the front polarizer is easily damaged, pay attention not to scratch it.
- f) Since long contact with water may cause discoloration or spots, wipe off water drop immediately.
- g) When the panel surface is soiled, wipe it with absorbent cotton or other soft cloth.
- h) Since the panel is made of glass, it may break or crack if dropped or bumped on hard surface. Handle with care.
- i) Since CMOS LSI is used in this module, take care of static electricity and take the human earth into consideration when handling.
- j) The module has some printed circuit boards (PCBs) on the back side, take care to keep them from any stress or pressure when handling or installing the module; otherwise some of electronic parts on the PCBs may be damaged.
- k) Observe all other precautionary requirements in handling components.
- l) When some pressure is added onto the module from rear side constantly, it causes display non-uniformity issue, functional defect, etc.. So, please avoid such design.
- m) When giving a touch to the panel at power on supply, it may cause some kinds of degradation. In that case, once turn off the power supply, and turn on after several seconds again, and that is disappear.
- n) When handling LCD modules and assembling them into cabinets, please be noted that long-term storage in the environment of oxidization or deoxidization gas and the use of such materials as reagent, solvent, adhesive, resin, etc. which generate these gasses, may cause corrosion and discoloration of the LCD modules.

11. Packing form

- a) Piling number of cartons: 3 maximum
- b) Packing quantity in one carton: 8 pcs.
- c) Carton size: 710 (W) × 555 (D) × 585 (H)
- d) Total mass of one carton filled with full modules: 55 kg(Max)

12. Reliability test item

No.	Test item	Condition
1	High temperature storage test	Ta=60 240h
2	Low temperature storage test	Ta=-25 240h
3	High temperature and high humidity operation test	Ta=40 ; 95%RH 240h (No condensation)
4	High temperature operation test	Ta=50 240h
5	Low temperature operation test	Ta=0 240h
6	Vibration test (non-operation)	Frequency: 10~57Hz/Vibration width (one side): 0.075mm : 58~500Hz/Acceleration: 9.8 m/s ² Sweep time: 11 minutes Test period: 3 hours (1h for each direction of X, Y, Z)
7	Shock test (non-operation)	Maximum acceleration: 490m/s ² Pulse width: 11ms, sinusoidal half wave Direction: +/-X, +/-Y, +/-Z, once for each direction.
8	ESD	* At the following conditions, it is a thing without incorrect operation and destruction. (1)Non-operation: Contact electric discharge ± 10kV Non-contact electric discharge ± 20kV (2)Operation Contact electric discharge ± 8kV Non-contact electric discharge ± 15kV Conditions: 150pF、330ohm

【Result evaluation criteria】

Under the display quality test condition with normal operation state, there shall be no change, which may affect practical display function.

13. Others

1) Lot No. Label ;

The label that displays SHARP, product model (LQ255T3LY44A), a product number and “MADE IN JAPAN” is stuck on the back of the module.

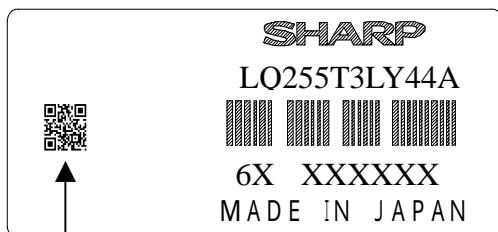

- ← Model No.
- ← Barcode
- ← Lot No.

2D Barcode

How to express Lot No.

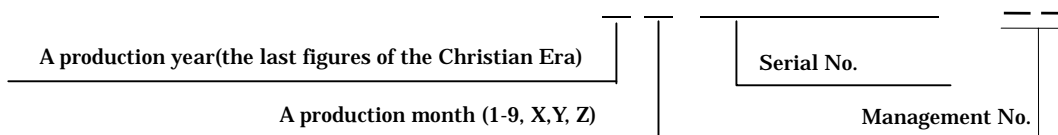

2) Packing Label

社内品番 (4 S) LQ255T3LY44A	
Bar code	
Lot No. (1 T) 2 0 0 6 . * . * * ()	
Bar code	
Quantity (Q)	8 p c s ()
Bar code	
ユーザ品番	
シャープ物流用ラベルです。	

Management No. (LQ255T3LY44A)

Lot No. (Date)

Quantity

- 3) Disassembling the module can cause permanent damage and should be strictly avoided.
- 4) Please be careful since image retention may occur when a fixed pattern is displayed for a long time.
- 5) The chemical compound, which causes the destruction of ozone layer, is not being used.

14. Carton storage condition

Temperature	0 to 40
Humidity	95%RH or less
Reference condition	: 20 to 35 , 85%RH or less (summer) : 5 to 15 , 85%RH or less (winter) • the total storage time (40 , 95%RH) : 240H or less
Sunlight	Be sure to shelter a product from the direct sunlight.
Atmosphere	Harmful gas, such as acid and alkali which bites electronic components and/or wires must not be detected.
Notes	Be sure to put cartons on palette or base, don't put it on floor, and store them with removing from wall Please take care of ventilation in storehouse and around cartons, and control changing temperature is within limits of natural environment
Storage life	1 year

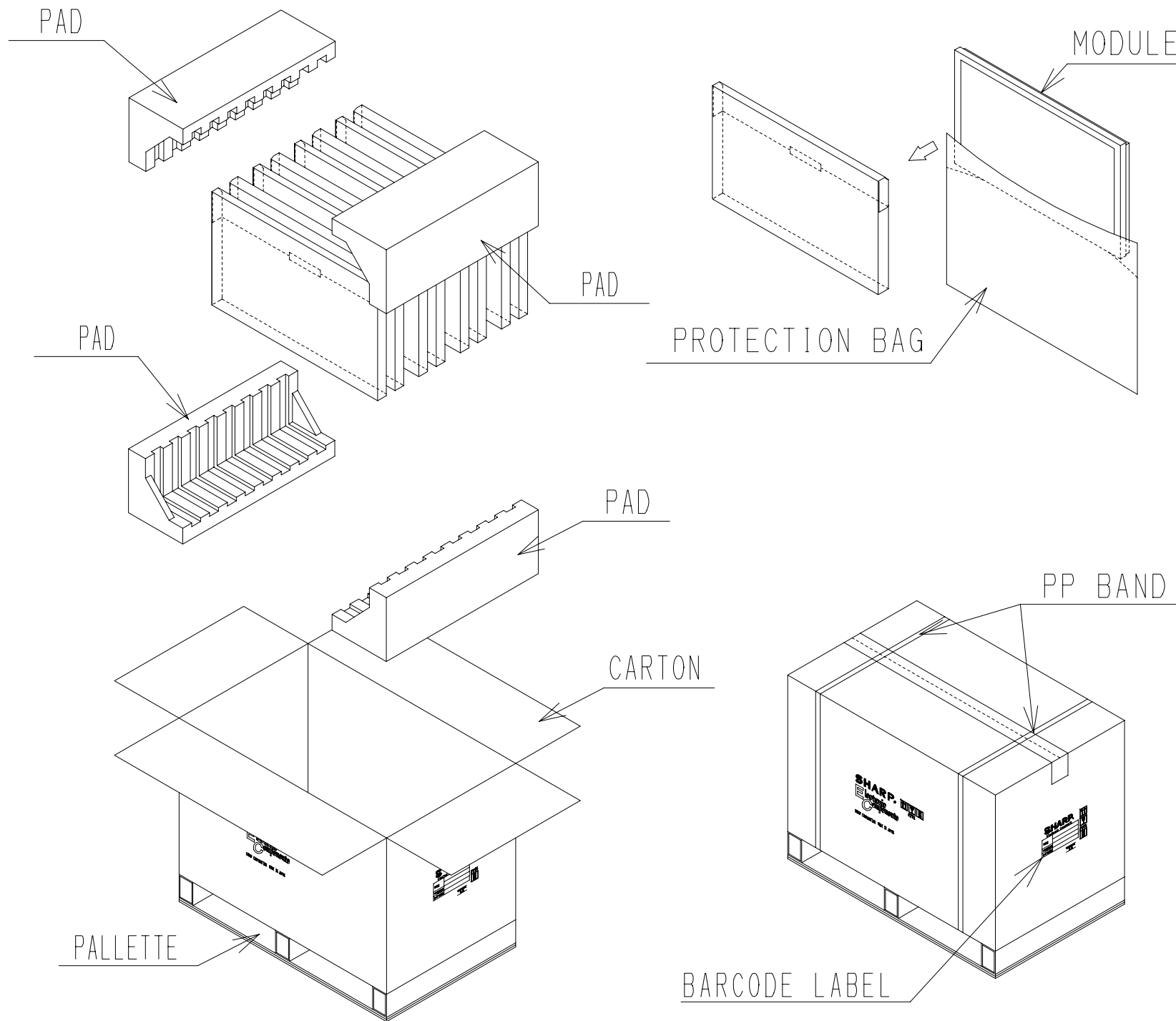

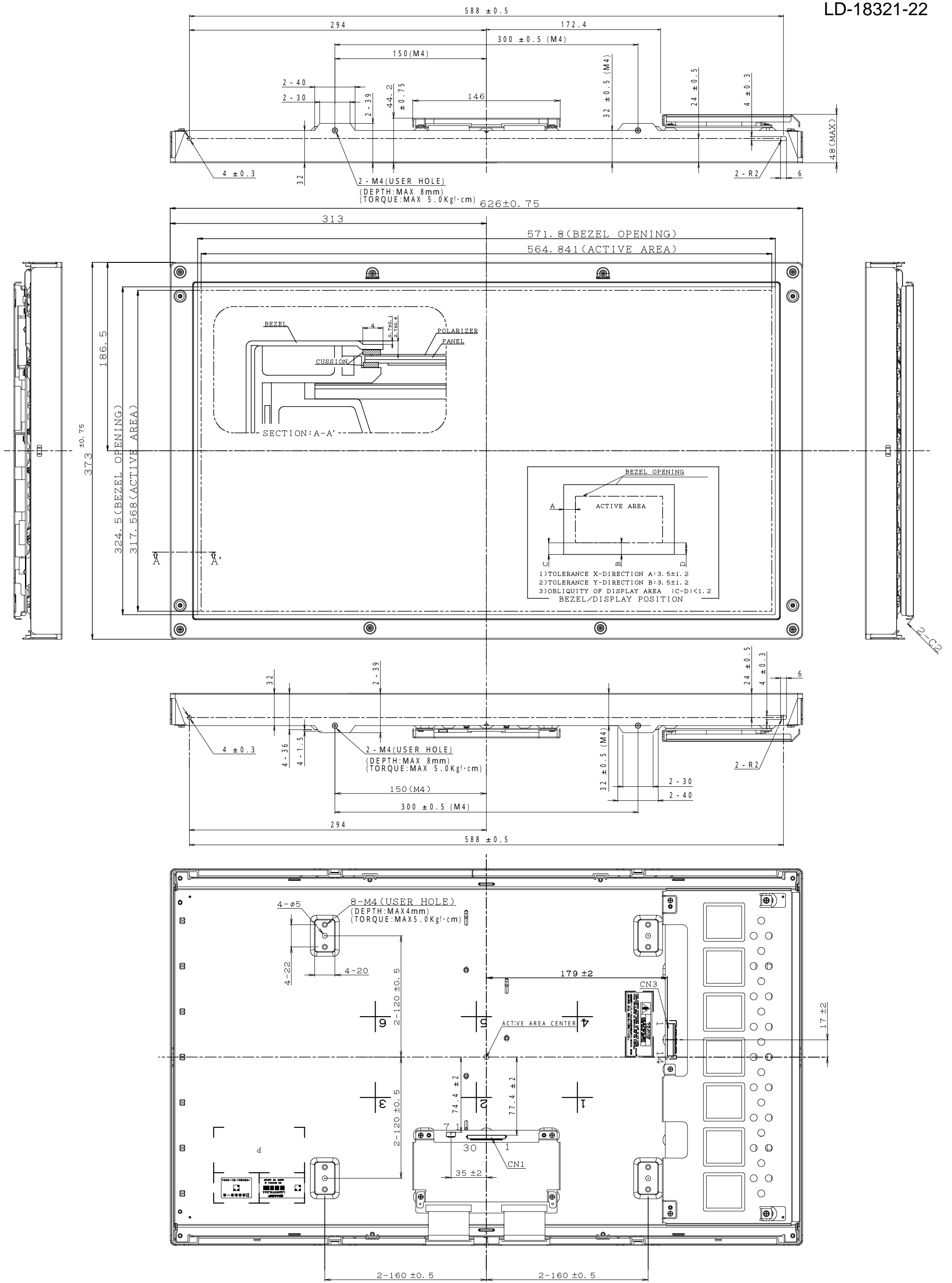

NOTE)
1. UNSPECIFIED TOLERANCE TO BE ± 1.0

DATE: 2005. 07. 08

Fig 1 OUTLINE DIMENSIONS