

PREPARED BY: _____ DATE _____
APPROVED BY: _____ DATE _____

SHARP

LIQUID CRYSTAL DISPLAY GROUP
SHARP CORPORATION

SPECIFICATION

SPEC No. LD-6401
FILE No. _____
ISSUE: Apr. 22, 1994
PAGE : 16 pages
APPLICABLE GROUP
Liquid Crystal Display
Group

DEVICE SPECIFICATION FOR
TFT-LCD Modul
MODEL No.
LQ9D03B

CUSTOMER'S APPROVAL
DATE _____

BY _____

PRESENTED BY *H. Fukuoka*
H. FUKUOKA
Department General Manager
Engineering Department 2
TFT LCD Development Center
LIQUID CRYSTAL DISPLAY GROUP
SHARP CORPORATION

1. Application

This specification applies to color TFT-LCD module. LQ9D03B.

2. Overview

This module is a color active matrix LCD module incorporating amorphous silicon TFT (Thin Film Transistor). It is composed of a color TFT-LCD panel, driver ICs, control circuit, power supply circuit and a backlight unit. Graphics and texts can be displayed on a 640×3×480 dots panel in 4,096 colors by supplying 12 bit data signal(4bit/color), four timing signals, +5V DC supply voltage for TFT-LCD panel driving and supply voltage for backlight. Optimum viewing direction is 6 o'clock.

400 line and 350 line modes in addition to the 480 line mode can be also applied for this module.

Backlight-driving DC/AC inverter is not built in this module.

3. Mechanical Specifications

Parameter	Specifications	Unit
Display size	21 (8.4") Diagonal	cm
Active area	170.9(H)×129.6(V)	mm
Pixel format	640(H)×480(V)	pixels
	(1 pixel = R + G + B dots)	
Pixel pitch	0.267(H)×0.270(V)	mm
Pixel configuration	R, G, B vertical stripe	
Display mode	Normally white	
Unit outline dimensions #1	242.5(W)×179.4(H)×8.7(D)	mm
Mass	480±20	g
Surface treatment (Haze)	Anti-glare and hard-coating 2H (25 ^{±5})	(%)

#1. Note: excluding backlight cables.

Outline dimensions is shown in Fig.1

4. Input Terminals

LD6401-2

4-1. TFT-LCD panel driving

CN1

Used connector:DF9B-31PA-1V (Hirose Electric Co., Ltd.)

Corresponding connector:DF9B-31S-1V ()

Pin No.	Symbol	Function	Remark
1	R0	RED data signal (LSB)	
2	GND		
3	R1	RED data signal	
4	Vsync	Vertical synchronous signal	【Note1】
5	R2	RED data signal	
6	Hsync	Horizontal synchronous signal	【Note1】
7	R3	RED data signal (MSB)	
8	GND		
9	GND		
10	CK	Clock signal for sampling each data signal	
11	G0	GREEN data signal (LSB)	
12	GND		
13	G1	GREEN data signal	
14	TST	This should be electrically opened during operation	
15	GND		
16	TST	This should be electrically opened during operation	
17	G2	GREEN data signal	
18	GND		
19	G3	GREEN data signal (MSB)	
20	GND		
21	GND		
22	Vcc	+5V power supply	
23	B0	BLUE data signal (LSB)	
24	Vcc	+5V power supply	
25	B1	BLUE data signal	
26	TST	This should be electrically opened during operation	
27	GND		
28	ENAB	Data enable signal	【Note2】
29	B2	BLUE data signal	
30	GND		
31	B3	BLUE data signal (MSB)	



CN1

※The shielding case is connected with GND.

【Note1】 480line, 400line or 350line mode is selected by the polarity combination of the both synchronous signals.

mode	480line	400line	350line
Hsync	negative	negative	positive
Vsync	negative	positive	negative

It is equivalent to 480line mode if the both synchronous signals are positive. But the vertical display start timing is different from the normal 480line mode in this case.

【Note2】 The horizontal display start timing is settled with a rising timing of this signal. In case ENAB is fixed "Low". The horizontal start timing is determined in the module. (refer to 7-2)

LD6401-3

4-2. Backlight driving

Used connector : BIR-03VS-1(JST)

CN2

Corresponding connector: SM02(8.0)B-BHS(JST)

Pin no.	symbol	function
1	V _{HIGH}	Power supply for lamp (High voltage side)
3	V _{LOW}	Power supply for lamp (Low voltage side)

5. Absolute Maximum Ratings

Parameter	Symbol	Condition	Ratings	Unit	Remark
Input voltage	V _i	Ta=25°C	-0.3 ~ V _{CC} +0.3	V	【Note1】
+5V supply voltage	V _{CC}	Ta=25°C	0 ~ +7	V	
Storage temperature	T _{stg}	-	-25 ~ +60	°C	【Note2】
Operating temperature (Ambient)	T _{op}	-	0 ~ +50	°C	

【Note1】 CK, R0-R3, G0-G3, B0-B3, Hsync, Vsync, ENAB

【Note2】 Humidity : 95%RH Max. at Ta≤40°C.

Maximum wet-bulb temperature at 39°C or less at Ta>40°C.

No condensation.

6. Electrical Characteristics

6-1. TFT-LCD panel driving

Ta = 25°C

Parameter	Symbol	Min.	Typ.	Max.	Unit	Remark
+5V Supply voltage	V _{CC}	+4.5	+5.0	+5.5	V	【Note1】
	I _{CC}	-	200	(400)	mA	【Note2】
Permissible input ripple voltage	V _{rip}	-	-	100	mVp-p	V _{CC}
Input voltage (Low)	V _{IL}	-	-	+0.8	V	V _{CC} =+5V
Input voltage (High)	V _{IH}	+2.0	-	-	V	【Note3】
Input current (low)	I _{OL}	-	-	1.0	μA	V _i =0V 【Note3】
Input current (High)	I _{OHI1}	-	-	1.0	μA	V _i =V _{CC} 【Note4】
	I _{OHI2}	-	-	60.0	μA	V _i =V _{CC} 【Note5】

【Note1】

Vcc-turn-on conditions
 rise time : $t1 \leq 10\text{msec}$
 data allowance time : $t2 \leq 10\text{msec}$
 decay time : $t3 > 0\text{msec}$

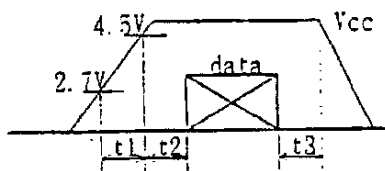

Vcc-dip conditions

- 1) $2.7\text{V} \leq V_{cc} < 4.5\text{V}$
 $t_d \leq 10\text{msec}$
- 2) $V_{cc} < 2.7\text{V}$

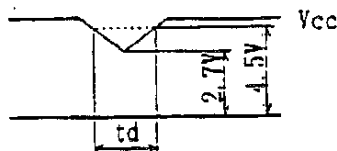

Vcc-dip conditions should also follow the Vcc-turn-on conditions

【Note2】 Typical current situation : Black pattern
 480 line mode
 $V_{cc} = 5.0\text{V}$

【Note3】 CK, R0-R3, G0-G3, B0-B3, Hsync, Vsync, ENAB

【Note4】 CK, R0-R3, G0-G3, B0-B3, Hsync, Vsync

【Note5】 ENAB

6-2. Backlight driving

The backlight system is an edge-lighting type with single CCFT.
 The characteristics of lamp are shown in the following table.

$T_a = 25^\circ\text{C}$

Parameter	Symbol	Min.	Typ.	Max.	Unit	Remark
Lamp voltage	V_L	-	470	-	Vrms	Just for reference
Lamp current	I_L	4.0	4.5	5.0	mA rms	
Lamp power consumption	P_L	-	2.1	-	W	【Note 1】
Lamp frequency	F_L	20	-	60	kHz	【Note 2】
Kick-off voltage	V_k	-	-	1100	Vrms	$T_a = 25^\circ\text{C}$
		-	-	1400		$T_a = 0^\circ\text{C}$
Lamp life time	T_L	10000	-	-	h	【Note 3】

【Note 1】 Calculated value for reference. ($I_L \times V_L$)

【Note 2】 Lamp frequency may produce interference with horizontal sync. frequency, and this may cause beat on the display. Therefore lamp frequency should be detached as much as possible from the horizontal sync. frequency and from the harmonics of horizontal sync. to avoid interference.

【Note 3】 Brightness becomes 50% of the original value under standard condition.
 ($I_L = 4.5\text{mA rms}$)

7. Timing Characteristics of input signals

Timing diagrams of input signals are shown in Fig.2-①~③.

7-1. Timing characteristics

Parameter	Symbol	Mode	Min.	Typ.	Max.	Unit	Remark	
Clock	Frequency	1/Tc	all	-	25.18	31.5	MHz	【Note 1】
	High time	Tch	-	5	-	-	ns	
	Low time	Tcl	-	10	-	-	ns	
Data	Setup time	Tds	-	5	-	-	ns	
	Hold time	Tdh	-	10	-	-	ns	
Horizontal sync. signal	Cycle	TH	-	30.00	31.78	-	ns	
			-	770	800	900	clock	
	Pulse width	THp	-	2	96	200	clock	
Vertical sync. signal	Cycle	TV	480	515	525	560	line	
			400	445	449	480	line	
			350	447	449	510	line	
	Pulse width	TVp	all	2	-	34	line	
Horizontal display period	THd	-	640	640	640	clock		
Hsync-Clock phase difference	THc	-	10	-	Tc-10	ns		
Hsync-Vsync phase difference	TVh	-	0	-	TH-THp	ns		

【Note 1】 This Max. value is only applicable to logic function.

Note) In case of lower frequency, the deterioration of display quality, flicker etc. may be occurred.

7-2. Horizontal display position and Data enable signal(ENAB)

The horizontal display position is settled by data enable signal (ENAB) and
The horizontal display starts from rising of ENAB.

Parameter	Symbol	Mode	Min.	Typ.	Max.	Unit	Remark
Enable signal (ENAB)	Setup time	Tes	all	5	-	Tc-10	ns
	Pulse width	Tep	-	2	640	640	clock
Hsync-ENAB phase difference	THE	-	44	-	164	clock	

Note) If ENAB is fixed "Low", the horizontal display starts from the data of C104(clock) as shown in Fig.2-①~③.

LD6401-6

7-3. Vertical display position

If sync. signals have the polarity described in 4-1. (Note1) and have values shown in the following table, the vertical display position is automatically centered at each mode of VGA : 480 line, 400 line and 350 line.

In 400 and 350 lines modes, the display position will not be centered on the screen if the cycle of vertical sync. signal, TV, deviates from above typical values.

The data enable signal has no relation to the vertical display position.

mode	V-data start(TVs)	V-data period(TVd)	V-display start	V-display period	Unit	Remark
480	34	480	34	480	line	
400	34	400	443-TV	480	line	【Note1】
350	61	350	445-TV	480	line	

【Note1】 Since the data in the vertical data invalid period is displayed in 400 and 350 line modes, inputting all data "0" is recommended during vertical data invalid period. (refer to the following figures)

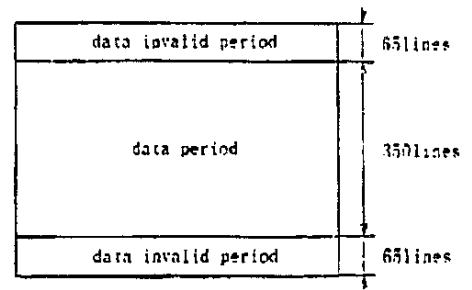
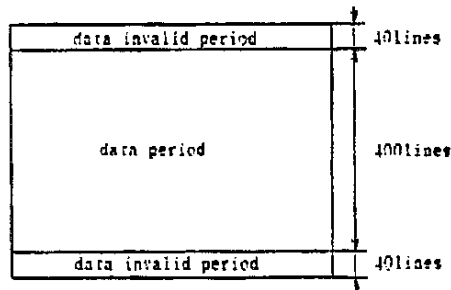

7-4. Input Data Signals and Display Position on the screen

Display position of input data (480 line mode)
(H·V)

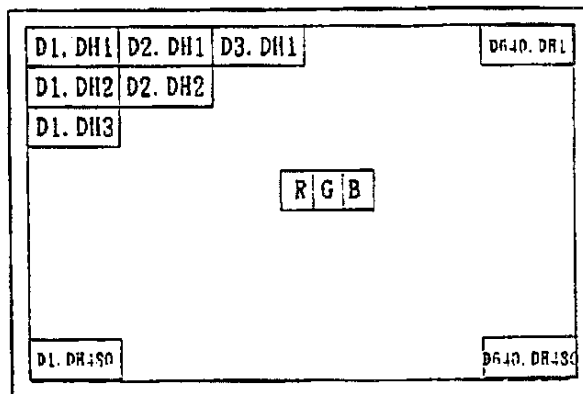

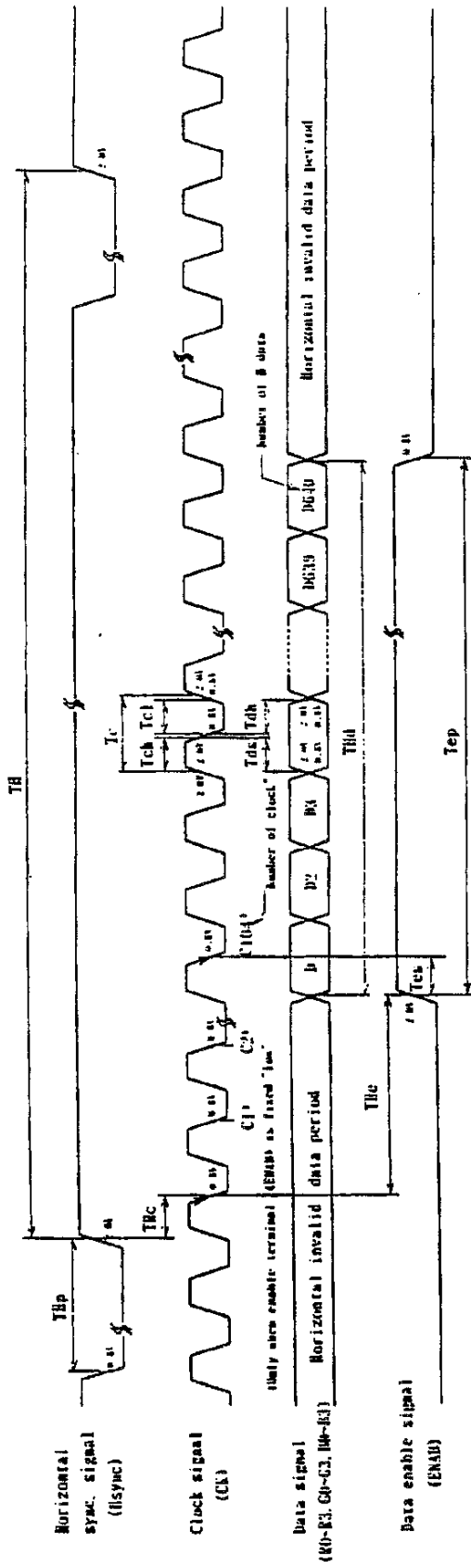

Fig. 2-0 Input signal waveforms (480 line mode)

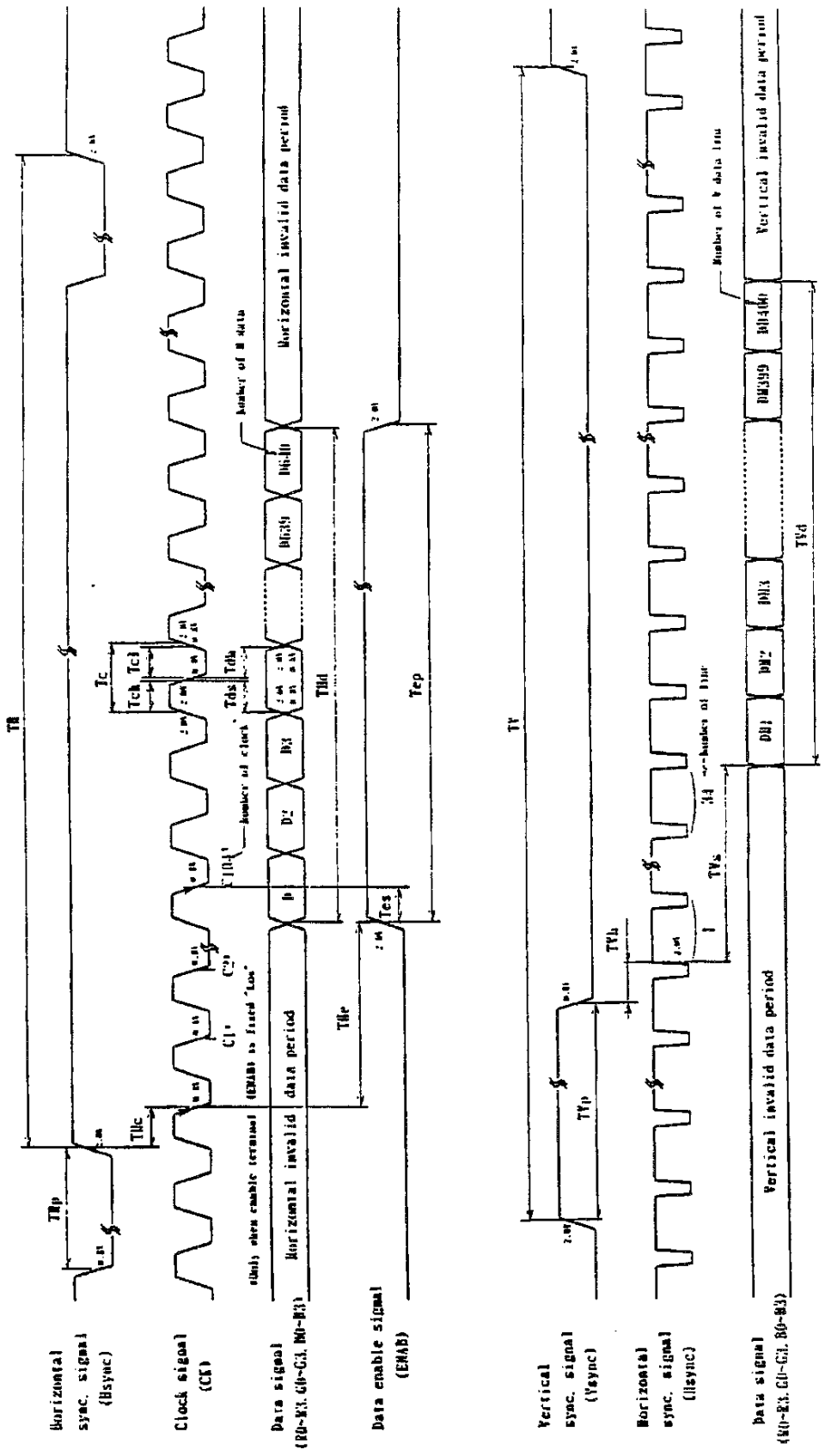

Fig. 2-2 Input signal waveforms (400 line mode)

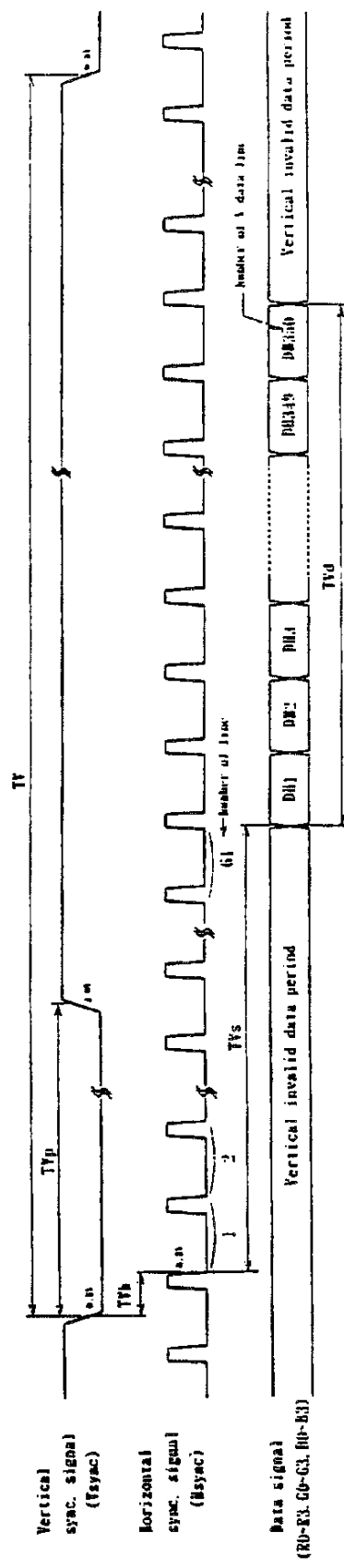
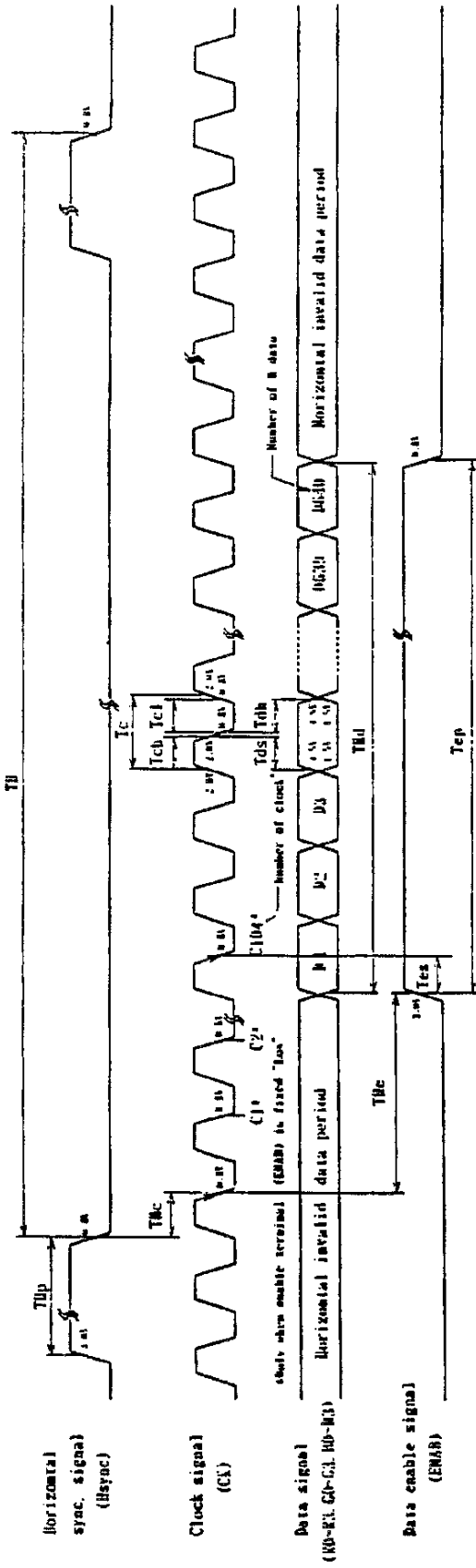

Fig. 2-4 Input signal waveforms (350 line mode)

8. Input Signals, Basic Display Colors and Gray Scale of Each Color

Color & Gray scale	Data signals												
	R0	R1	R2	R3	G0	G1	G2	G3	B0	B1	B2	B3	
Basic color	Black	0	0	0	0	0	0	0	0	0	0	0	0
	Blue	0	0	0	0	0	0	0	0	1	1	1	1
	Green	0	0	0	0	1	1	1	1	0	0	0	0
	Light blue	0	0	0	0	1	1	1	1	1	1	1	1
	Red	1	1	1	1	0	0	0	0	0	0	0	0
	Purple	1	1	1	1	0	0	0	0	1	1	1	1
	Yellow	1	1	1	1	1	1	1	1	0	0	0	0
	White	1	1	1	1	1	1	1	1	1	1	1	1
Gray Scale of Red	Black	0	0	0	0	0	0	0	0	0	0	0	0
	↑	1	0	0	0	0	0	0	0	0	0	0	0
	Darker	0	1	0	0	0	0	0	0	0	0	0	0
	↑												
	↓												
	Brighter	1	0	1	1	0	0	0	0	0	0	0	0
↓	0	1	1	1	0	0	0	0	0	0	0	0	
Red	1	1	1	1	0	0	0	0	0	0	0	0	
Gray Scale of Green	Black	0	0	0	0	0	0	0	0	0	0	0	0
	↑	0	0	0	0	1	0	0	0	0	0	0	0
	Darker	0	0	0	0	0	1	0	0	0	0	0	0
	↑												
	↓												
	Brighter	0	0	0	0	1	0	1	1	0	0	0	0
↓	0	0	0	0	0	1	1	1	0	0	0	0	
Green	0	0	0	0	1	1	1	1	0	0	0	0	
Gray Scale of Blue	Black	0	0	0	0	0	0	0	0	0	0	0	0
	↑	0	0	0	0	0	0	0	0	1	0	0	0
	Darker	0	0	0	0	0	0	0	0	0	1	0	0
	↑												
	↓												
	Brighter	0	0	0	0	0	0	0	0	1	0	1	1
↓	0	0	0	0	0	0	0	0	0	1	1	1	
Blue	0	0	0	0	0	0	0	0	1	1	1	1	

0: Low level voltage
1: High level voltage

Each color is displayed in 16 gray scales from 4 bit data signals input. According to the combination of total 12 bit data. 4.096 colors are displayed.

9. Optical Characteristics

Ta=25°C, Vcc=+5V

Parameter	Symbol	Condition	Min.	Typ.	Max.	Unit	Remark	
Viewing angle range	Horizontal	$\theta 21.22$	CR > 10	3.5	-	-	°	【Note1, 4】
	Vertical	$\theta 11$		1.0	-	-	°	
		$\theta 12$		3.0	-	-	°	
Contrast ratio	CR	Optical viewing angle	6.0	10.0	-	-	【Note2, 4】	
Response time	Rise	r_r	$\theta = 0^\circ$	-	3.0	-	ms	【Note3, 4】
	Decay	r_d		-	5.0	-	ms	
Chromaticity of white	x		-	0.313	-	-	【Note4】	
	y		-	0.329	-	-		
Chromaticity of red	x		-	0.535	-	-		
	y		-	0.340	-	-		
Chromaticity of green	x		-	0.295	-	-		
	y		-	0.485	-	-		
Chromaticity of blue	x		-	0.153	-	-		
	y		-	0.135	-	-		
Luminance of white	Y_w		5.0	7.0	-	cd/m ²		
White Uniformity	δ_w		-	-	1.45	%	【Note5】	
Shadowing	S				2.0	%	【Note6】	

※The measurement shall be executed 15-20 minutes after lighting at rating. (I₁=4.5mA rms)
 The optical characteristics shall be measured in a dark room or equivalent state with the method shown in Fig. 3 below.

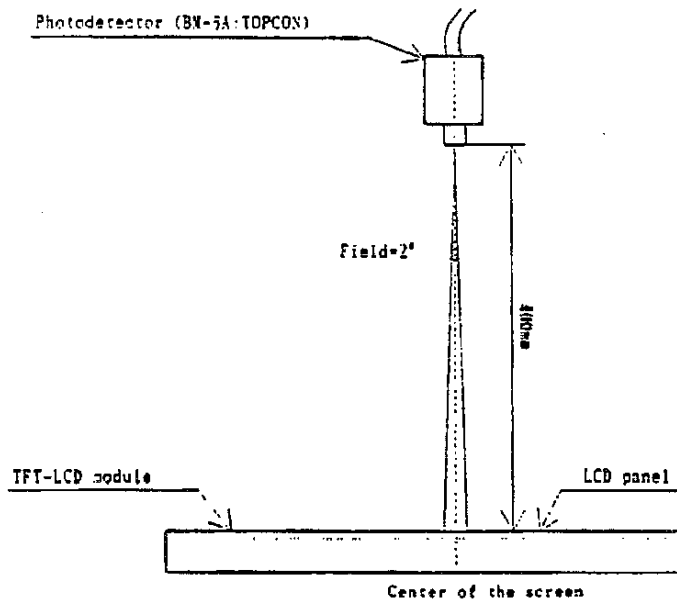
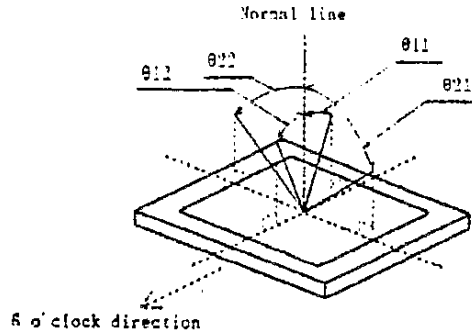

Fig. 3 Optical characteristics measurement method

【Note1】 Definitions of viewing angle :



【Note2】 Definition of Contrast Ratio:

The contrast ratio is defined as the following.

$$\text{Contrast Ratio} = \frac{\text{Luminance (brightness) with all pixels white}}{\text{Luminance (brightness) with all pixels black}}$$

【Note3】 Definitions of Response Time:

The response time is defined as the following figure and shall be measured by switching the input signals for "black" and "white".

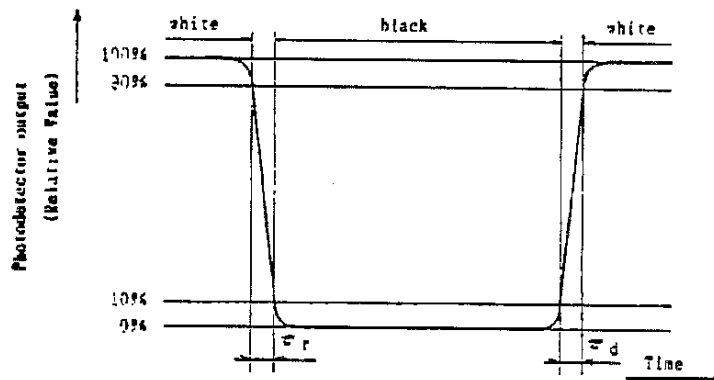

【Note4】 This shall be measured at center of the screen.

【Note5】 Definition of White Uniformity

White Uniformity is defined as the following with five measurements (A-E).

$$\delta_w = \frac{\text{Maximum Luminance of five points (brightness)}}{\text{Minimum Luminance of five points (brightness)}}$$

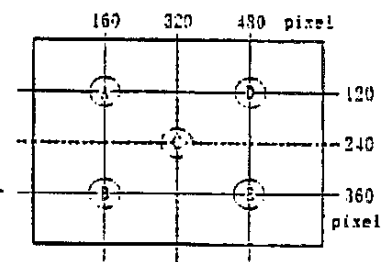

【Note6】 Definition of Shadowing

Shadowing is defined as follows.

$$S = (|YA - YB| / YA) \times 100 (\%)$$

YA&YB: Brightness of same measured area

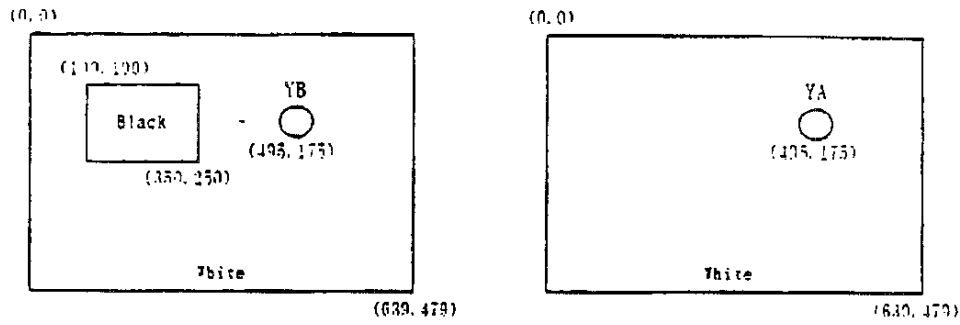

10. Display quality

The display quality of the color TFT-LCD module shall be in compliance with the Incoming Inspection Standard.

11. Handling Precautions

- 11-1. Be sure to turn off the power supply when inserting or disconnecting the cable.
- 11-2. Others
 - a) Be sure to design the cabinet so that the module can be installed without any extra stress such as warp or twist.
 - b) Since the front polarizer is easily damaged, pay attention not to scratch it.
 - c) Wipe off water drop immediately. Long contact with water may cause discoloration or spots.
 - d) When the panel surface is soiled, wipe it with absorbent cotton or other soft cloth.
 - e) Since the panel is made of glass, it may break or crack if dropped or bumped on hard surface. Handle with care.
 - f) Since CMOS LSI is used in this module, take care of static electricity and injure the human earth when handling.
 - g) Observe all other precautionary requirements in handling components.

12. Packing form

- a) Piling number of cartons : MAX. 7
 - b) Package quantity in one carton : MAX. 10
 - c) Carton size : 413(W)x288(H)x351(D) mm
 - d) Total mass of 1 carton filled with full modules : 7000g
- Packing form is show in Fig.4.

13. Reliability test items

No.	Test item	Conditions
1	High temperature storage test	Ta=60°C 240h
2	Low temperature storage test	Ta=-25°C 240h
3	High temperature & high humidity operation test	Ta=40°C/95%RH 240h (No condensation)
4	High temperature operation test	Ta=50°C 240h (The panel temp. must be less than 60°C)
5	Low temperature operation test	Ta=0°C 240h
6	Vibration test (non-operating)	Frequency: 10~57Hz/Vibration width (one side): 0.075mm :58~500Hz/Gravity: 9.8m/s ² Sweep time: 11 minutes Test period: 3 hours (1 hour for each direction of X, Y, Z)
7	Shock test (non-operating)	Max. gravity: 490m/s ² Pulse width: 11ms. sine wave Direction: ±X, ±Y, ±Z once for each direction.

[Result Evaluation Criteria]

Under the display quality test conditions with normal operation state, these shall be no change which may affect practical display function.

14. Others

1-1) Bar code Label: Model No. →

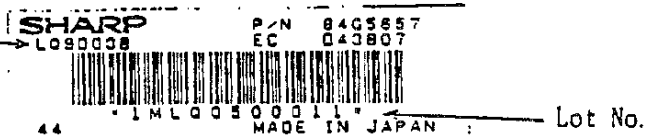

1-2) Caution-label:

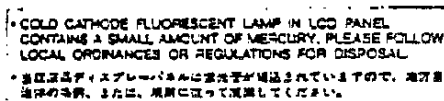

- 2) Adjusting volume has been set optimally before shipment, so do not change any adjusted value. If adjusted value is changed, the data mentioned in this specification may not be satisfied.
- 3) Disassembling the module can cause permanent damage and should be strictly avoided.
- 4) If any problem occurs in relation to the description of this specification, it shall be resolved through discussion with spirit of cooperation.

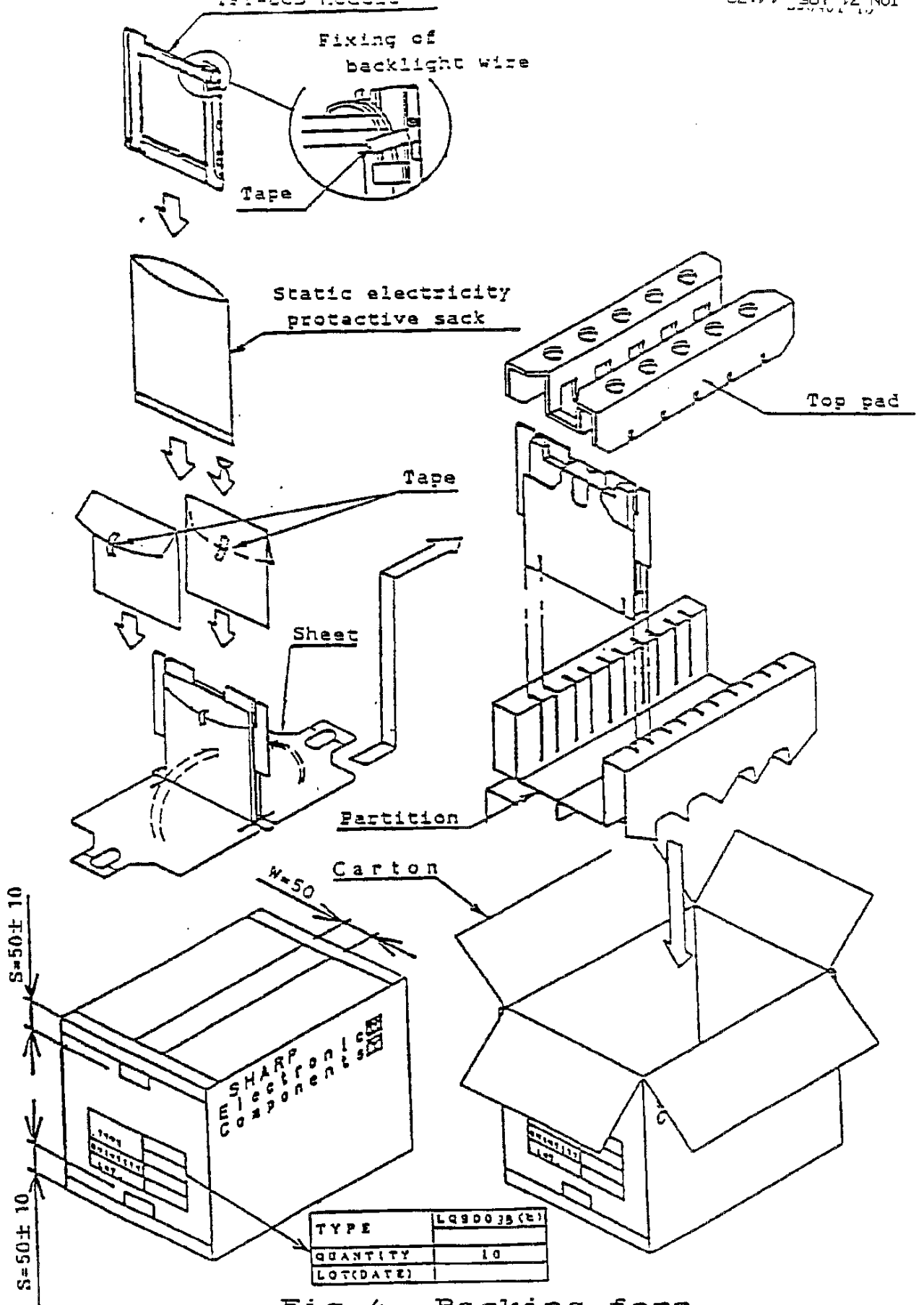

Fig. 4 Packing form

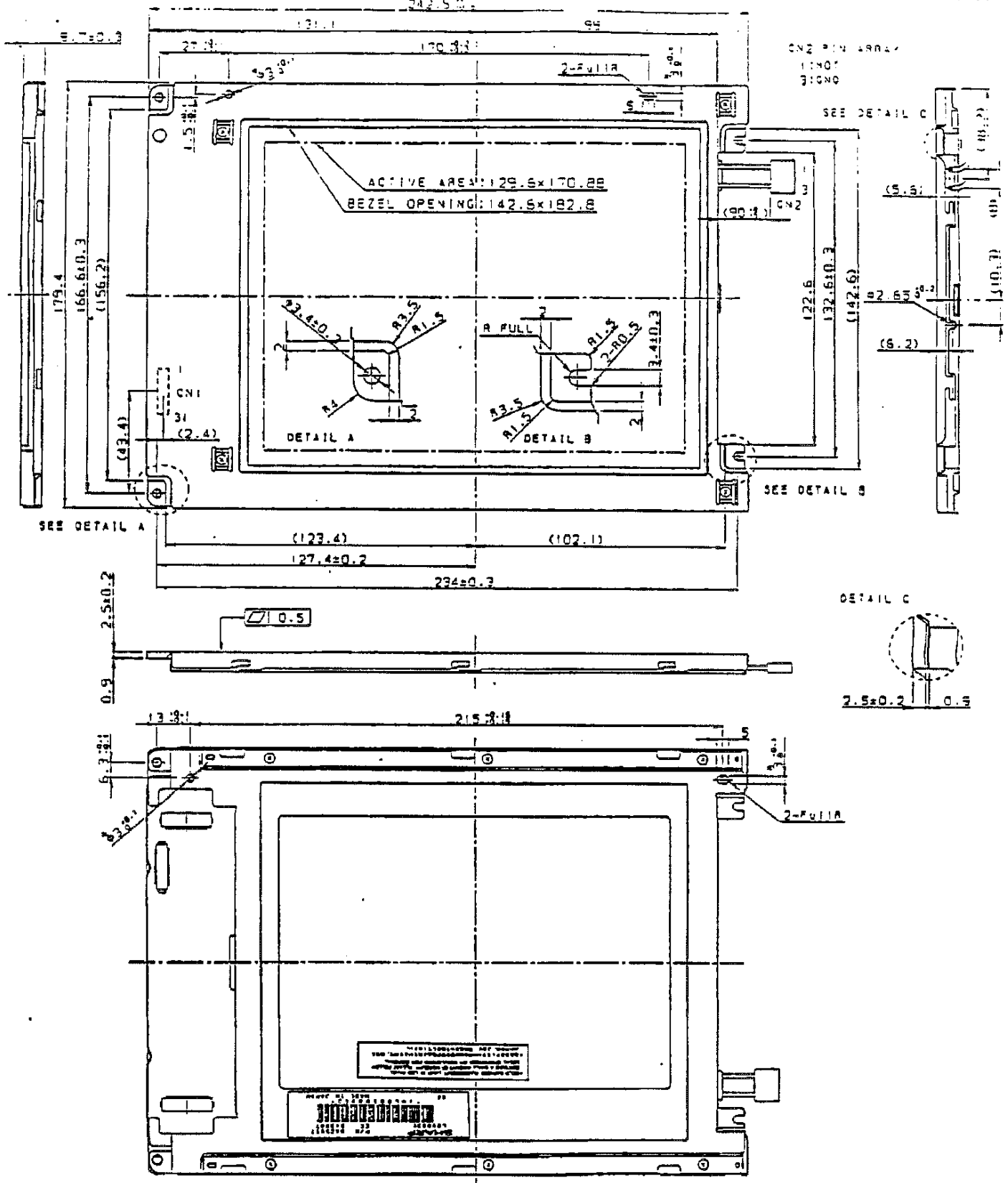
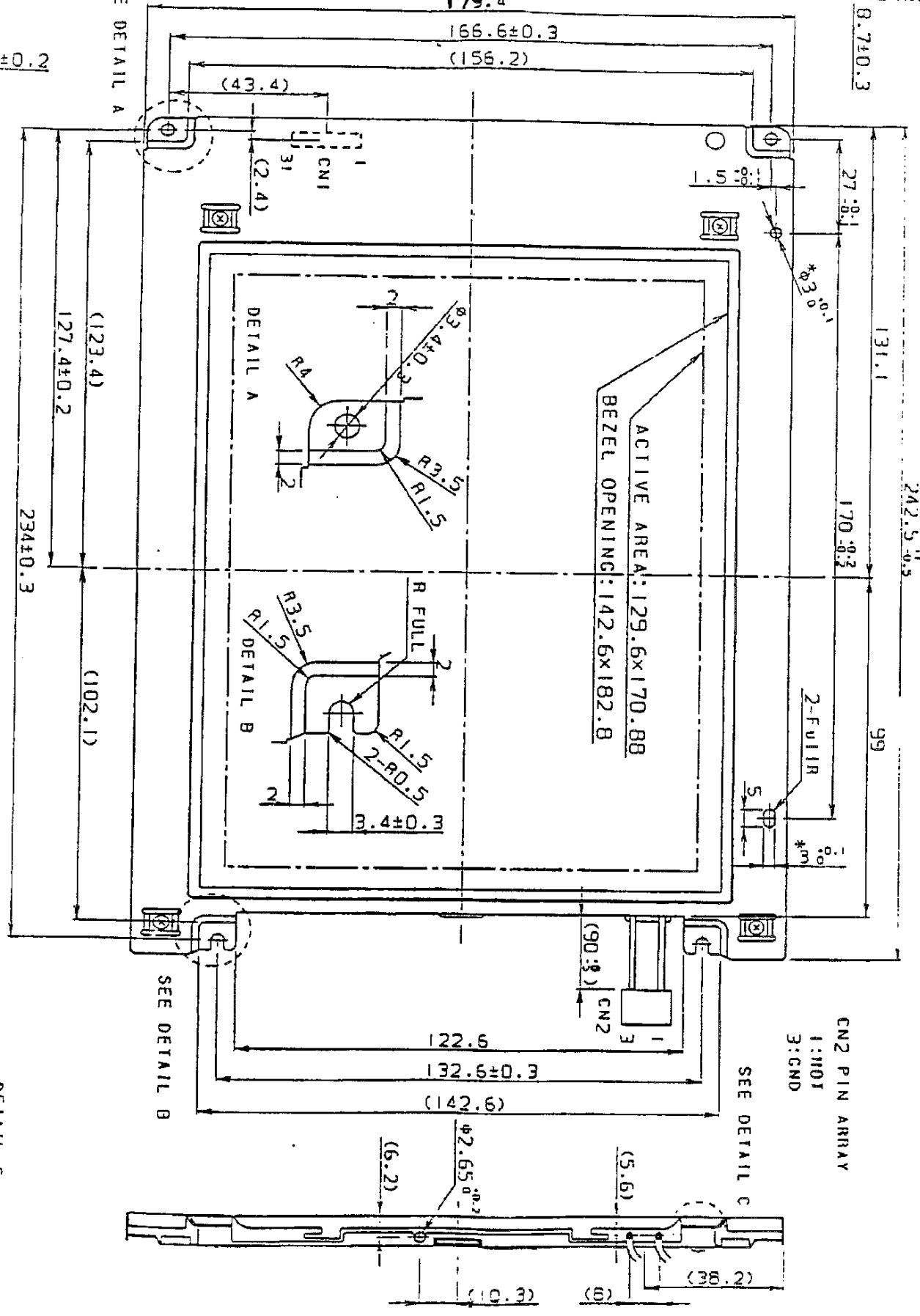
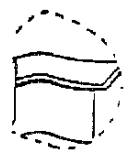
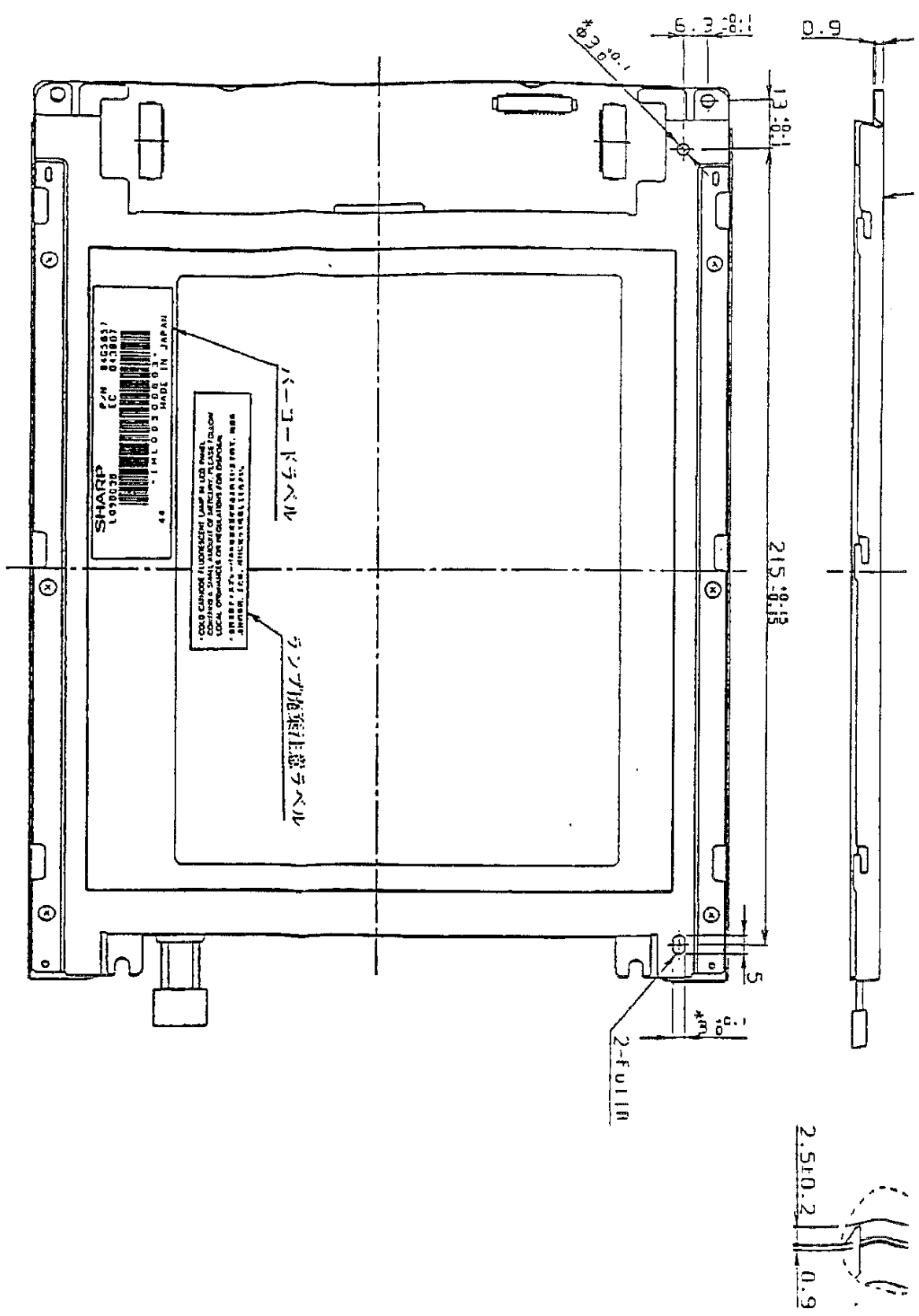

Fig. 1 OUTLINE DIMENSIONS



DETAIL C





指示精度公差は±0.5

*この-規格は、RNDの（中）に（ ）は、この-規格を利用
して作成された、この-規格の規格番号は、1.5mm、規格2mm

図1 外形図