

LQH3NPN470MGR#

indicates a package specification code.



< List of part numbers with package codes >
LQH3NPN470MGRL , LQH3NPN470MGRK

Shape

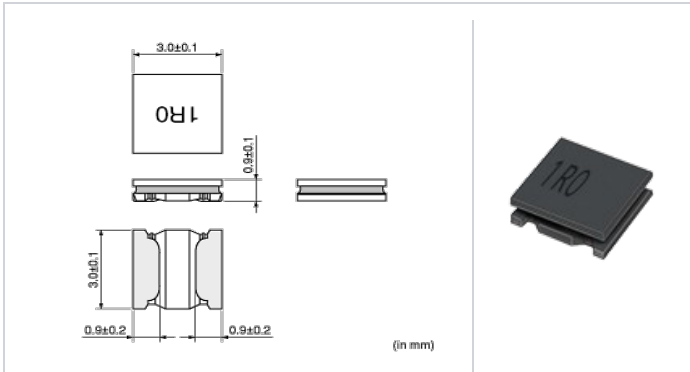

L size	3.0 ±0.1mm
W size	3.0 ±0.1mm
T size	0.9 ±0.1mm
Size code in inch (mm)	1212 (3030)

Notes

When rated current is applied to the products, inductance will be within ±30% of initial inductance value range.
Keep the temperature (ambient temperature plus self-generation of heat) under 125°C.
When rated current is applied to the products, the temperature rise caused by self-generated heat shall be limited to 40°C (at the rated current under 85°C) or 20°C (at the rated current under 105°C).

References

Packaging code	Specifications	Minimum quantity
L	φ180mm Embossed taping	3000
K	φ330mm Embossed taping	11000

Mass (Typ.)	
1 piece	0.034g

Specifications

Inductance	47μH ±20%
Inductance test frequency	1MHz
Rated current (I _{sat}) (Based on Inductance change)	260mA
Rated current (I _{temp}) (Based on Temperature rise)	460mA(Ambient temp.85°C) 270mA(Ambient temp.105°C)
Max. of DC resistance	1.68Ω
Avg. of DC resistance	1.4Ω±20%
Self resonance frequency (min.)	5MHz
Operating temperature range (Self-temperature rise is included)	-40°C to 125°C
Operating temperature range (Self-temperature rise is not included)	-40°C to 105°C
Class of magnetic shield	Magnetic Resin
Series	LQH3NPN_GR

Attention

- This datasheet is downloaded from the website of Murata Manufacturing Co., Ltd. Therefore, it's specifications are subject to change or our products in it may be discontinued without advance notice. Please check with our sales representatives or product engineers before ordering.
- This datasheet has only typical specifications because there is no space for detailed specifications. Therefore, please review our product specifications or consult the approval sheet for product specifications before ordering.

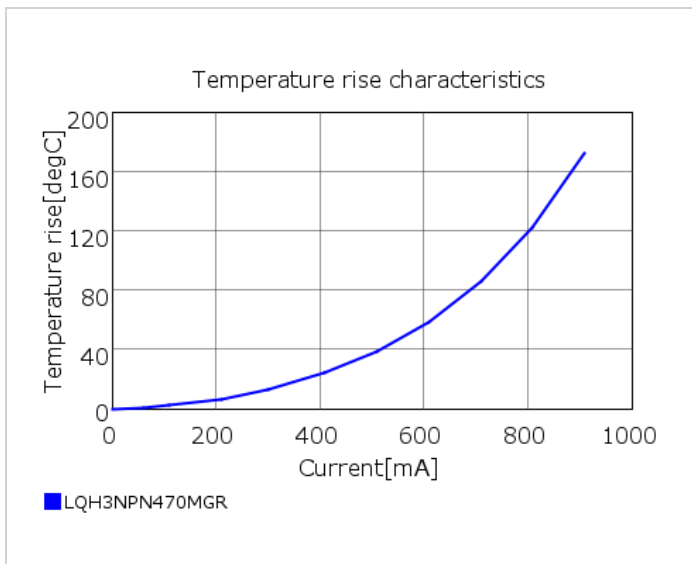
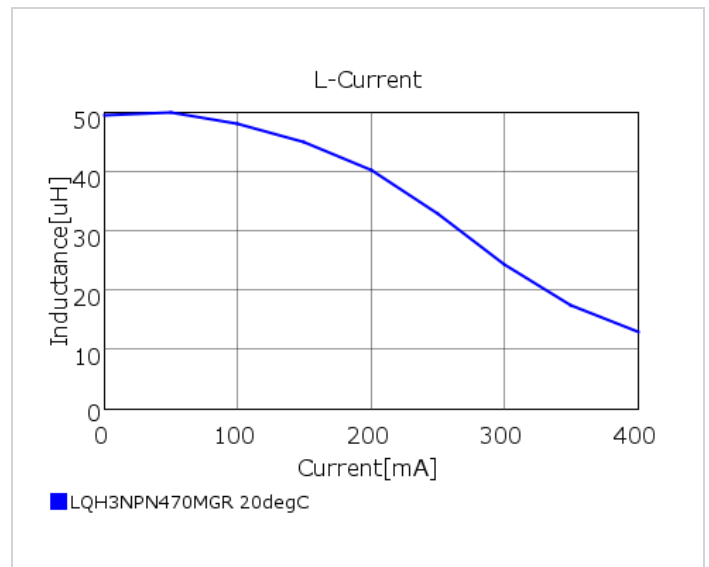
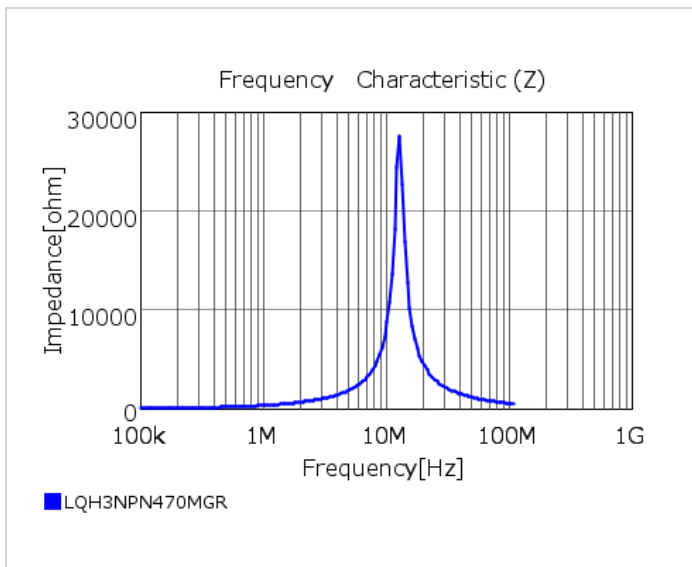
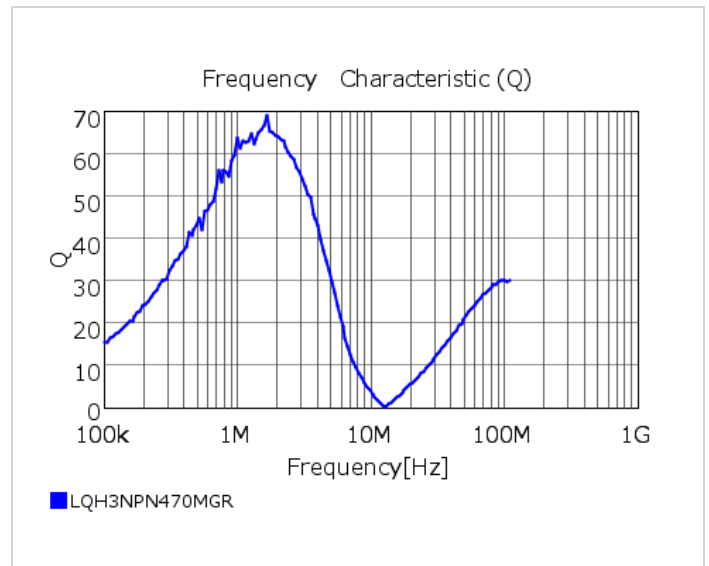
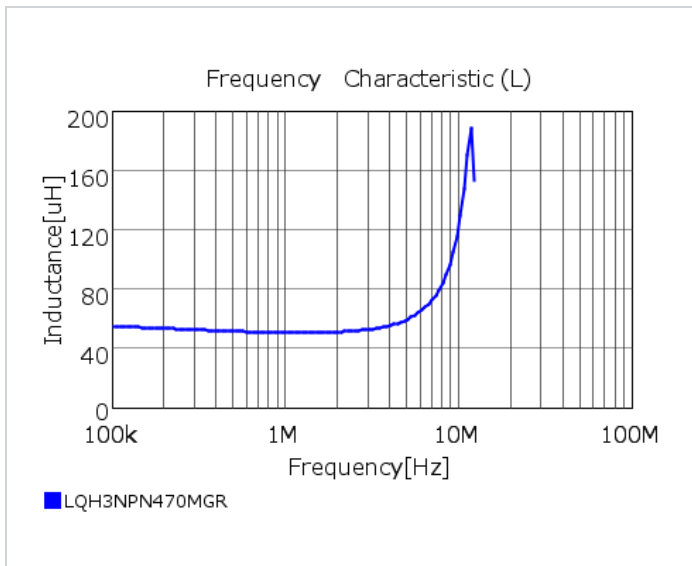

⚠ Attention

- 1.This datasheet is downloaded from the website of Murata Manufacturing Co., Ltd. Therefore, it's specifications are subject to change or our products in it may be discontinued without advance notice. Please check with our sales representatives or product engineers before ordering.
- 2.This datasheet has only typical specifications because there is no space for detailed specifications. Therefore, please review our product specifications or consult the approval sheet for product specifications before ordering.