

# LQM21PN1R5MC0#

# indicates a package specification code.



< List of part numbers with package codes >  
 LQM21PN1R5MC0D , LQM21PN1R5MC0B

## Shape

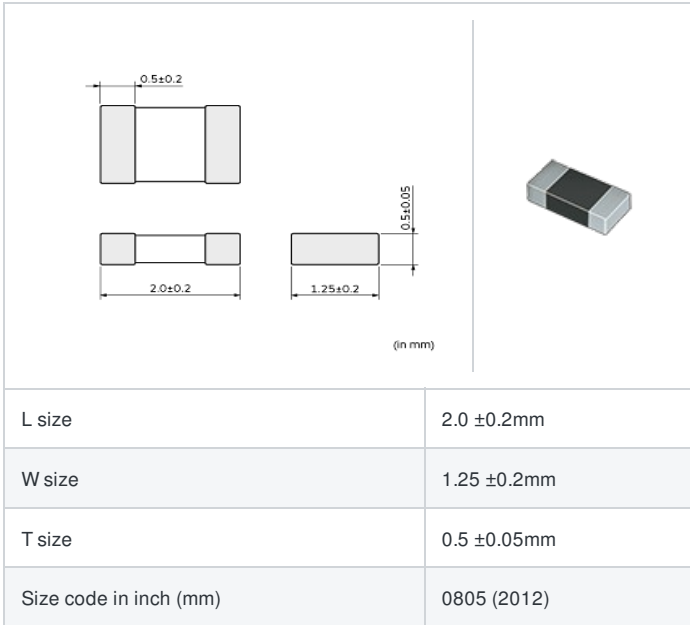

## Notes

In operating temperatures exceeding +85°C, derating of current is necessary for the LQM21P\_C0 series.  
 Please apply the derating curve shown in the chart according to the operating temperature.  
 Please consider "Notice (Rating)."  
 When rated current is applied to the products, the temperature rise caused by self-generated heat shall be limited to 40°C max.

## References

Packaging code	Specifications	Minimum quantity
D	φ180mm Paper taping	4000
B	Packing in bulk	1000

Mass (Typ.)	
1 piece	0.007g

## Specifications

Inductance	1.5μH ±20%
Inductance test frequency	1MHz
Rated current (Itemp) (Based on Temperature rise)	0.7A(Ambient temp.85°C) 0.52A(Ambient temp.125°C)
Max. of DC resistance	0.325Ω
Avg. of DC resistance	0.26Ω ±25%
Self resonance frequency (min.)	70MHz
Operating temperature range	-55°C to 125°C
Class of magnetic shield	Ferrite Core
Series	LQM21PN_C0

### Attention

- 1.This datasheet is downloaded from the website of Murata Manufacturing Co., Ltd. Therefore, it's specifications are subject to change or our products in it may be discontinued without advance notice. Please check with our sales representatives or product engineers before ordering.
- 2.This datasheet has only typical specifications because there is no space for detailed specifications. Therefore, please review our product specifications or consult the approval sheet for product specifications before ordering.

In operating temperatures exceeding +85°C, derating of current is necessary for this series.  
Please apply the derating curve shown in the chart according to the operating temperature.

Derating of Rated Current

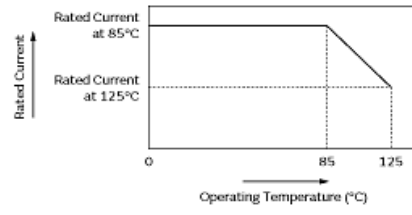

 **Attention**

- 1.This datasheet is downloaded from the website of Murata Manufacturing Co., Ltd. Therefore, it's specifications are subject to change or our products in it may be discontinued without advance notice. Please check with our sales representatives or product engineers before ordering.
- 2.This datasheet has only typical specifications because there is no space for detailed specifications.  
Therefore, please review our product specifications or consult the approval sheet for product specifications before ordering.

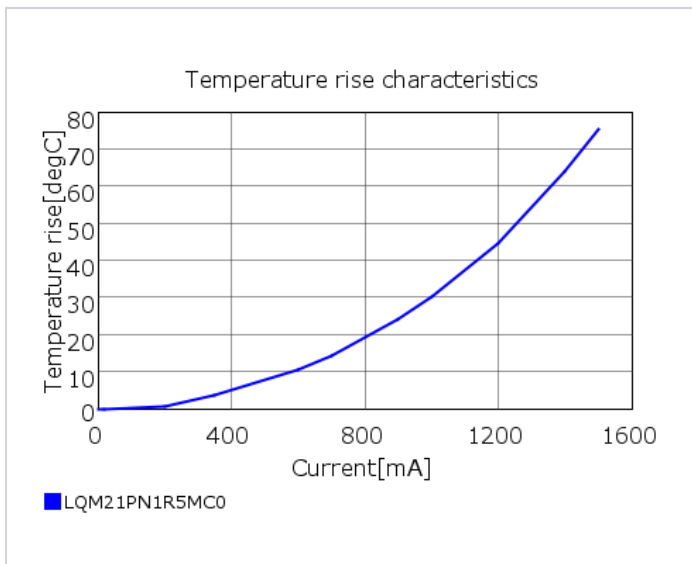
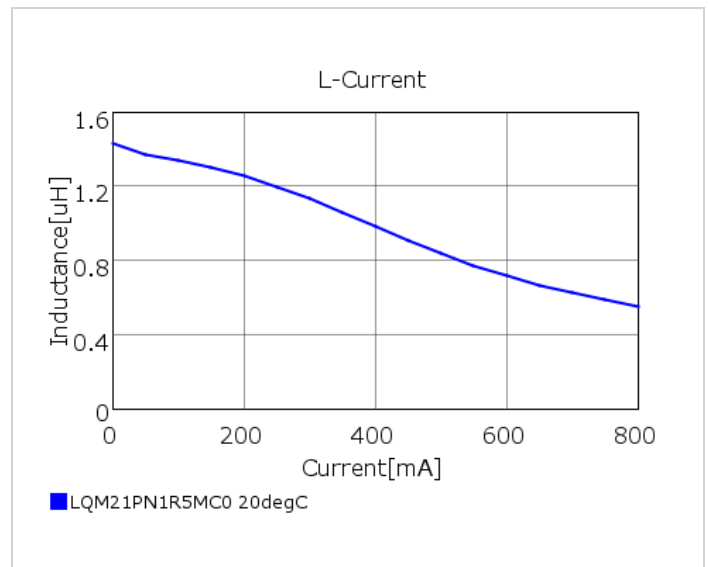
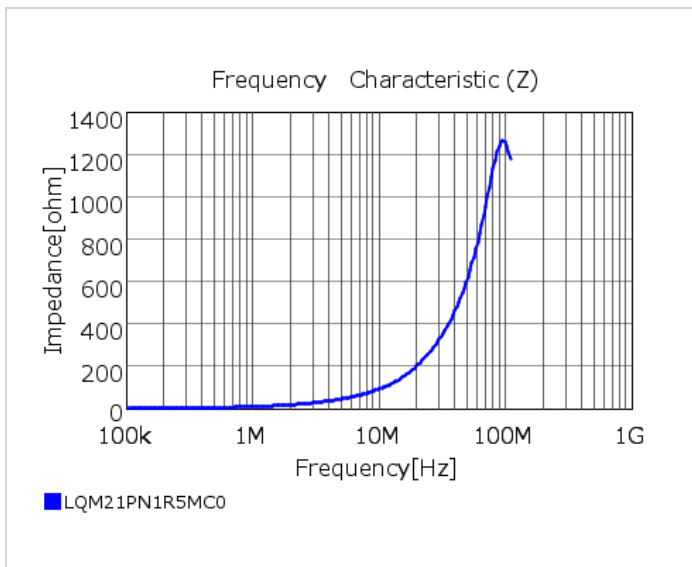
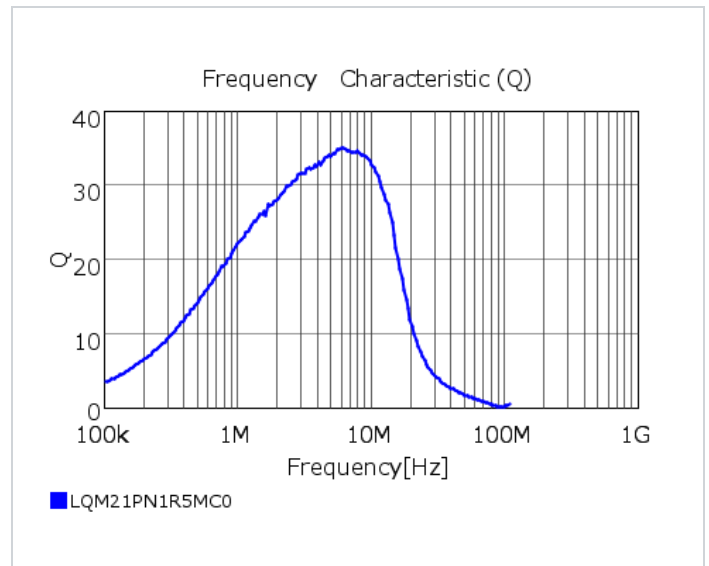
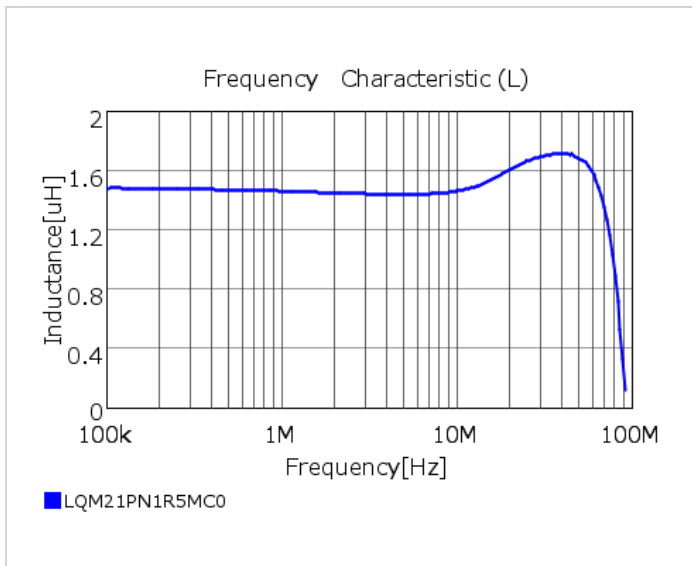

**Attention**

- 1.This datasheet is downloaded from the website of Murata Manufacturing Co., Ltd. Therefore, it's specifications are subject to change or our products in it may be discontinued without advance notice. Please check with our sales representatives or product engineers before ordering.
- 2.This datasheet has only typical specifications because there is no space for detailed specifications. Therefore, please review our product specifications or consult the approval sheet for product specifications before ordering.