

How to Order

LQT- X-

① ② ③

- (1) Model name
- (2) Representative frequency
- (3) Number of output

Specifications

Name of Product		LQT-50X-3	LQT-60X-3	LQT-64X	LQT-100X	LQT-1KX	LQT-10KX	LQT-100KX	
PIN No.	1	OUT (50Hz)	OUT (60Hz)	OUT (256Hz)	OUT (200Hz)	OUT (500Hz)	OUT (10KHz)	OUT (12.5KHz)	
	2	V _{DD} (+5.0V)	V _{DD} (+5.0V)	V _{DD} (+5.0V)	V _{DD} (+5.0V)	V _{DD} (+5.0V)	V _{DD} (+5.0V)	V _{DD} (+5.0V)	
	3	V _{SS} (GND)	V _{SS} (GND)	V _{SS} (GND)	V _{SS} (GND)	V _{SS} (GND)	V _{SS} (GND)	V _{SS} (GND)	
	4	RESET	RESET	RESET	RESET	OUT (4KHz)	OUT (80KHz)	OUT (100KHz)	
	5	OUT (12.5Hz)	OUT (15Hz)	OUT (64Hz)	OUT (50Hz)	OUT (2KHz)	OUT (40KHz)	OUT (50KHz)	
	6	OUT (25Hz)	OUT (30Hz)	OUT (128Hz)	OUT (100Hz)	OUT (1KHz)	OUT (20KHz)	OUT (25KHz)	
Voltage (in Operation)		5.0V(4.5 to 5.5V)				5.0V(4.5 to 5.5V)			
Output Frequency		12.5, 25, 50 Hz	15, 30, 60 Hz	64, 128, 256 Hz	50, 100, 200 Hz	500, 1K, 2K 4KHz	10K, 20K 40K, 80KHz	12.5K, 25K 50K, 100KHz	
Current Consumption (at no load)		1.5mA max				1.5mA max			
Operating temperature range		-20°C to +70°C				-20°C to +70°C			
Frequency precision (25°C±2°C, 5V)	0	10ppm							
	1	50ppm							
	2	110ppm							
	3	0.2%							
Frequency Variation Rate	Voltage Characteristic	±0.5ppm/0.1V TYPICAL				±0.5ppm/0.1V TYPICAL			
	Temperature Characteristic	±20ppm (-10°C to +60°C)				±20ppm (-10°C to +60°C)			
RESET		YES				NO			
Output From		C-MOS INVERTER				C-MOS INVERTER			
Output Wave Shape		Rectangular wave 50% duty				Rectangular wave 50% duty			
Case		NO CONNECTION				NO CONNECTION			

Adjustment to frequencies other than the standard types above is possible upon request.

Characteristics

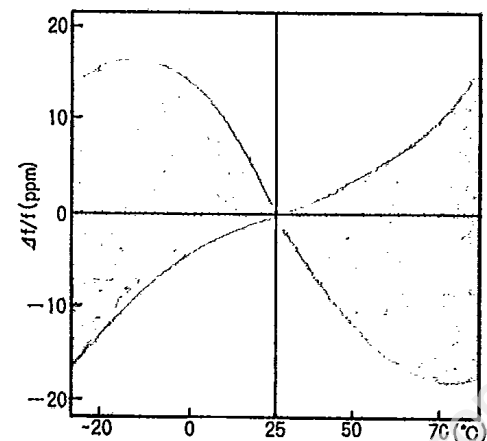

Fig. 1 Temperature - Oscillation Frequency Variation

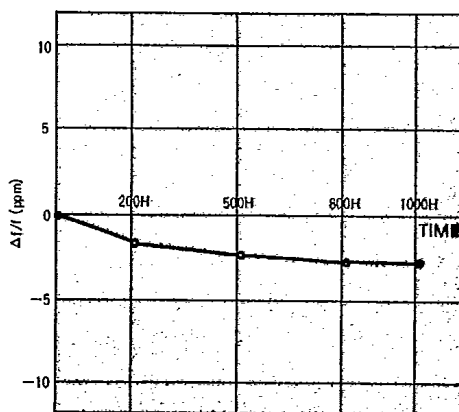

Fig. 2 High Temperature Exposure (85°C)

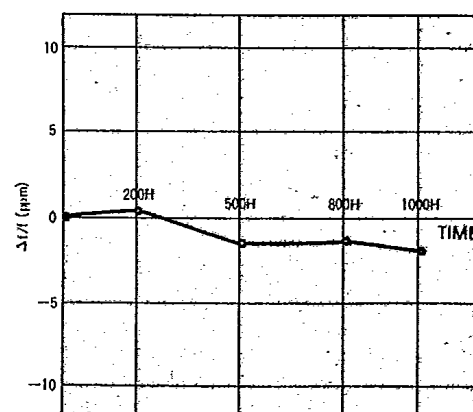

Fig. 3 Low Temperature Exposure (-40°C)

TBM LQT50X-1, 60X-1 are high-precision crystal oscillators composed of AT-cut crystal with excellent temperature features and low-energy, high-drive CMOS IC.

Existing power synchronization system can be revised into a high-precision crystal synchronization system with little effort, realizing improved sophistication, reliability, and global application of the system.

In particular, it has been simplified for output only of power frequencies most frequently used for high precision, high reliability, and low cost.

■ Features

- 1) Revision of the oscillator to the power supply sync system produces high-precision quartz synchronization.
- 2) The simple function (at 50 Hz or 60 Hz) realized low price and high precision.
- 3) Use of CMOS IC produces high output (TTL one-gate drive possible) at low energy consumption (5.0V 0.5mA at maximum).
- 4) The metal package makes it easy to prevent radiation of unwanted oscillation output, and maintains high reliability.

■ Applications

- 1) Quartz synchronization for power synchronization equipment
- 2) Oscillation for various high-precision timers
- 3) Oscillation for high-precision clocks

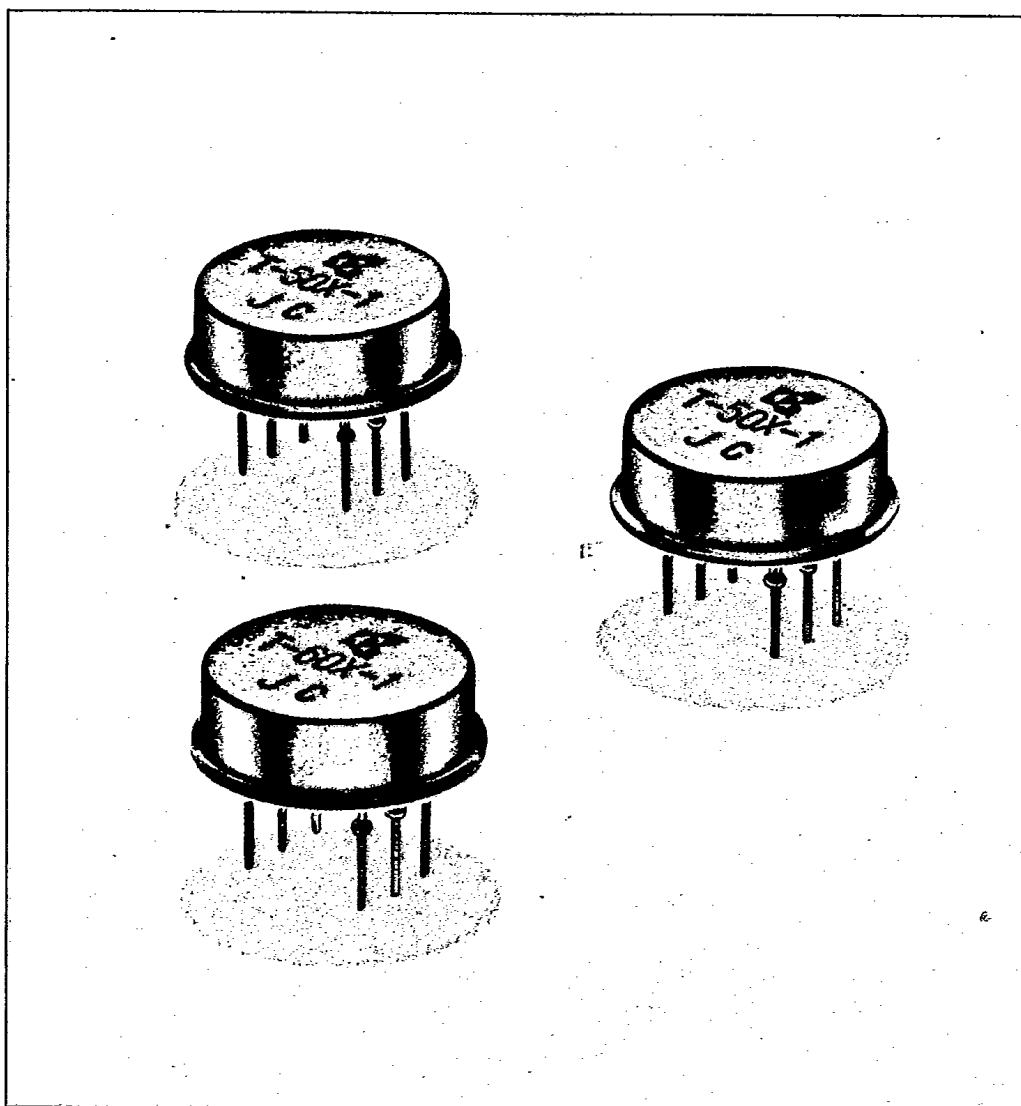

■ Dimensions & Pin Distribution

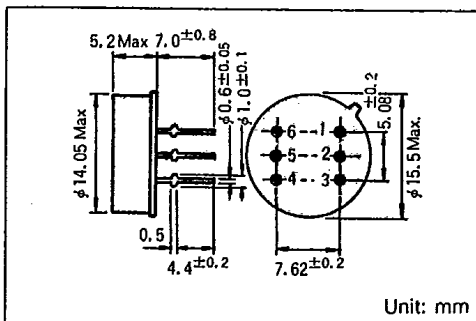

■ Pin Connection

PIN No.	1	OUT 50Hz
	2	Vcc
	3	Vss
	4	NO CONNECTION
	5	NO CONNECTION
	6	NO CONNECTION
Case		NO CONNECTION

■ How to Order

LQT - 50X - 1

① ② ③

- ① Model name
- ② Output frequency (50Hz or 60Hz)
- ③ Number of output

Maximum Absolute Rating

Classification	Code	Rating	Unit
Voltage	V _{cc}	-0.3 to +7.0	V
Operation Temperature	T _{opr}	-20 to +70	°C
Storage Temperature	T _{stg}	-40 to +90	°C

Specifications

Classification	Code	Rating	Unit	Remarks
Output Frequency	f _{out}	50 or 60	Hz	Cosine Wave 50% Duty
Output Frequency Error	Δf/f (25°C)	0: ±10	ppm	
		1: ±50	ppm	
		2: ±100	ppm	
		3: ±0.2	%	
Frequency Temperature Characteristic	Δf/f (T)	±20Max	ppm	-10°C--+60°C range based on T _a =25°C, V _{cc} =5.0V
Voltage Characteristic	Δf/f (V _{cc})	±2 Typical	ppm/V	
Range of Temperature in Operation	T _{opr}	-20 to +70	°C	
Range of Voltage	V _{cc}	+5.0±0.5	V	DC
Current Consumption (at no load)	I _{cc}	0.5Max	mA	
Output Current	I _{oh}	-1.6Min	mA	V _{cc} =5.0V, V _{oh} =AT3.8V
	I _{ol}	1.6Min	mA	V _{cc} =5.0V, V _{ol} =AT0.4V
Fan Out	n	TTL 1 Gate		

Comparative Study of LQT-50X-1 and 60X-1 with LQT-50X-3 and 60X-3

I _{ol} (0.4V)	Allowance Value (Minimum)	LQT-50X-1, 60X-1	LQT-60X-3, 60X-3	Unit
	Actual Value	6.2	1.6	0.5
I _{oh} (3.8V)	Allowance Value (Minimum)	-1.6	-0.5	mA
	Actual Value	-12.0	-0.6	mA
Current Consumption (at no load)	Maximum	0.5	1.5	mA
	Actual Value	0.2	0.9	mA
Voltage (V _{st}) at Oscillation Start		2.8	4.0	V
Voltage Characteristic		±2 Typical	±5 Typical	ppm/V

Test Circuit

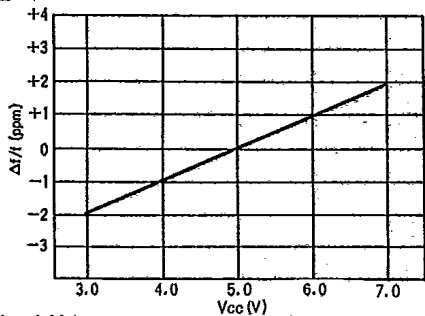

Fig. 4 Voltage - Example of Oscillation Frequency Variation Characteristic (T_a = 25°C)

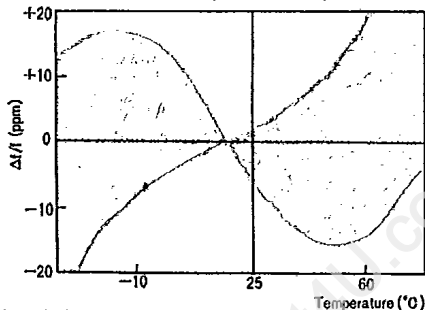

Fig. 5 Temperature - Oscillation Frequency Variation Characteristic (V_{dd} = 5.0V)

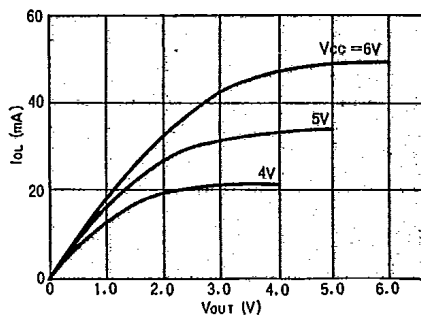

Fig. 6 Example of V_{out} Characteristic (T_a = 25°C)

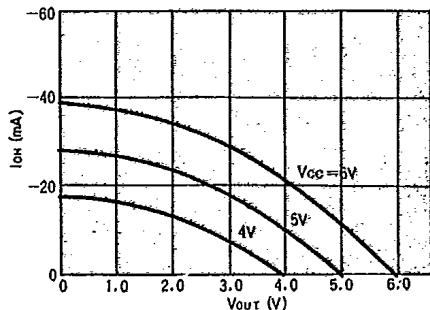

Fig. 7 Example of I_{oh} - V_{out} Characteristic (T_a = 25°C)

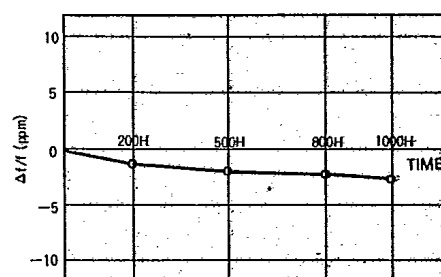

Fig. 8 High Temperature Exposure

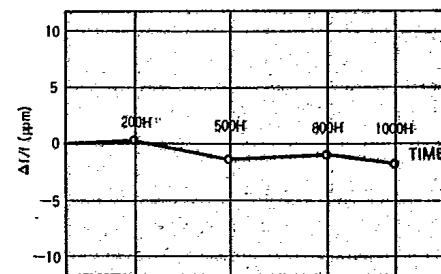

Fig. 9 Low Temperature Exposure Characteristic (T_a = 25°C)

CRYSTAL CLOCK OSCILLATORS
LQV Series

The TBM LQV Series are a line of unique, high-precision, wide-band, low-energy oscillators composed of mask-programmable 18-step binary counter CMOS IC and AT-cut crystal with superior temperature characteristics. Selection of oscillation output from 12 Hz to 8.0 MHz is possible with combination of the crystal's oscillation possible frequency and number of counter steps for maximum of 4 outputs from each step.

Semi-customized base oscillators ideal for systems design can be shipped to meet early delivery dates and at low prices. Various types of oscillation frequency bands with wide range of applications are available as standard mask for customer convenience.

■ Features

- 1) A wide selection of oscillation frequencies (12 Hz to 8.0 MHz) can make systems compact in size and adjustment-free.
- 2) Up to four outputs is possible at binary rate for concentration and standardization of oscillators.
Example: (1) 4,096 MHz, 2,048 MHz, 1,024 MHz, 1 KHz
(2) (3,2768 MHz, 1,638 MHz, 800 Hz, 50 Hz)
- 3) CMOS IC and AT-cut crystal produces good temperature characteristics (plus/minus 20 ppm maximum -10°C to +60°C) with low energy consumption and selection of frequency precision according to the type of use. (plus/minus 10 ppm, plus/minus 500 ppm, plus/minus 2,000 ppm)
- 4) High reliability and ease in radiation control are realized by the metal packaging
- 5) The mask-programmable product makes prototype and mass production is possible with short production time and external attachments unnecessary.
- 6) Oscillation band types that are most frequently used are available as standard masks.

■ Applications

- 1) Computers and peripheral equipment
- 2) Microcomputer application products
- 3) Various intelligent timers
- 4) Control equipment

■ Dimensions & Pin Distribution

Note: Out 1 through 4 are in order of output frequency

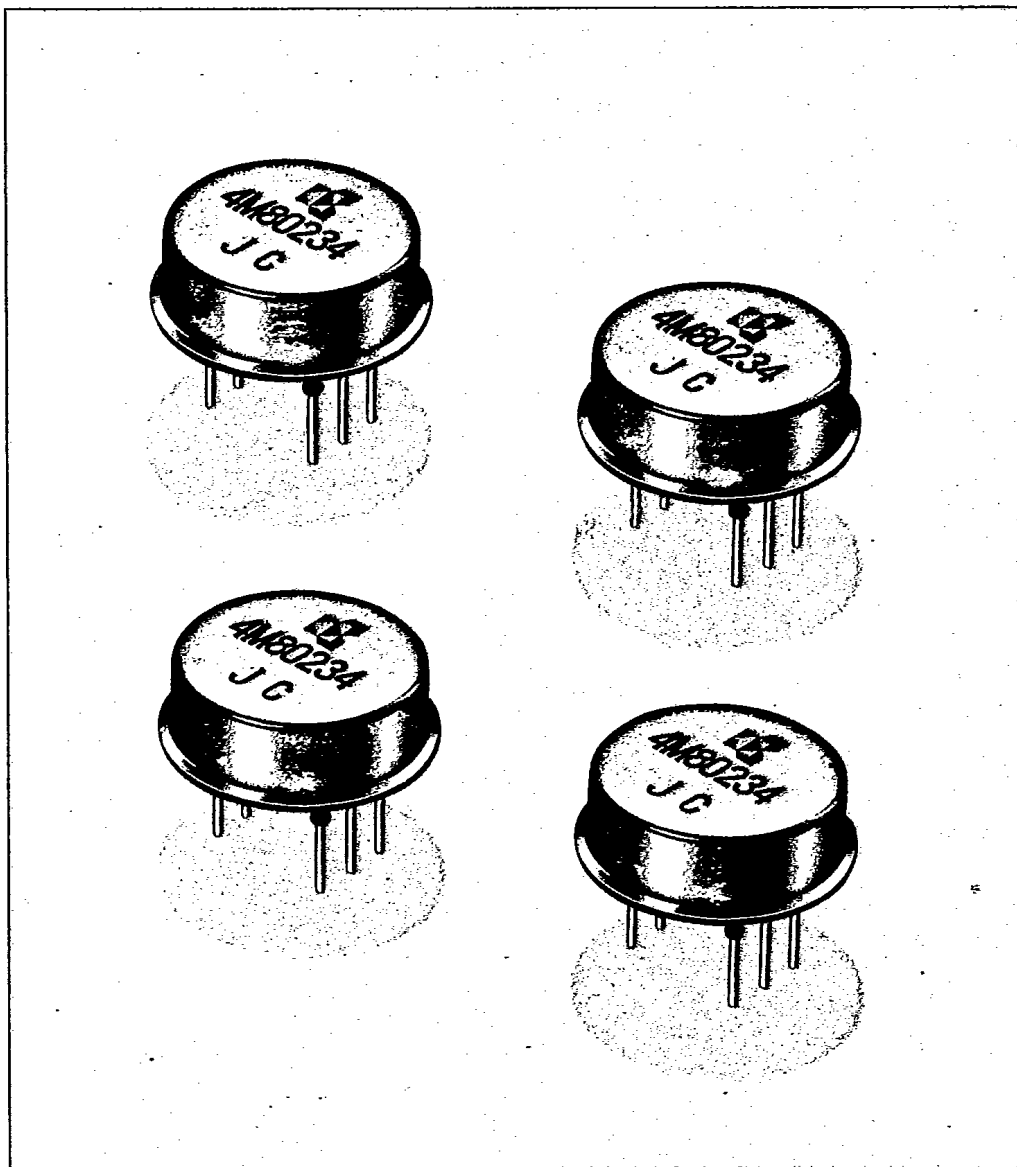

■ Dimensions

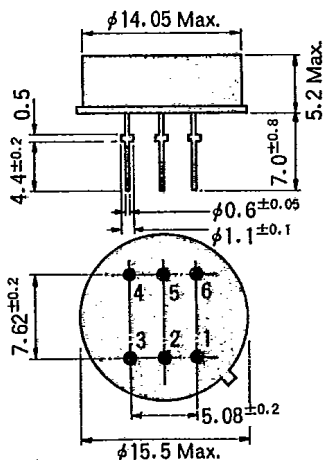



Unit: mm

■ Pin Connection

Pin No.	1	OUT 2
	2	OUT 1
	3	V _{CC}
	4	V _{SS}
	5	OUT 4 RESET
	6	OUT 3
		NO CONNECTION

Note: Out 1 through 4 are in order of output frequency

• CMOS IC is shown in dashed-line box  However, a selection of voluntary frequency comparison is possible due to mask-programmable wiring in solid-line box 

• The source oscillation crystal vibrator can be selected in the range between 3.0 to 8.0 MHz.

• Although the TMB has 6 pins and two are necessary for V_{dd} and V_{ss}, output is possible from a maximum of 4 pins.

• Resetting is also possible. In such a case, one pin is necessary for reset function, that the maximum number of output will be three. (n = Step 4 or later)

• Unnecessary pins become NC and should not be used as tie points terminals.

■ List of Standard Frequencies (Source Oscillation)

3.2000MHz	4.8000MHz
3.2768MHz	4.9152MHz
3.6864MHz	5.0000MHz
3.93216MHz	5.1200MHz
4.0000MHz	6.0000MHz
4.0960MHz	6.1440MHz
4.19430MHz	8.0000MHz

Model Name	Source Oscillation Frequency (kHz)	Output Frequency (kHz)
8M00-012	8.000	8.000M 4.000M 2.000M
6M00-012	6.000	6.000M 3.000M 1.500M
5M12-234	5.120	1.28M 640K 320K
4M194304-3QR	4.194304	524.288K 64 RESET
3M93216-01Q	3.932160	3.93216M 1.96608M 60
3M2768-3CQR	3.2768	409.6K 800 50 RESET

■ Function Block Diagram

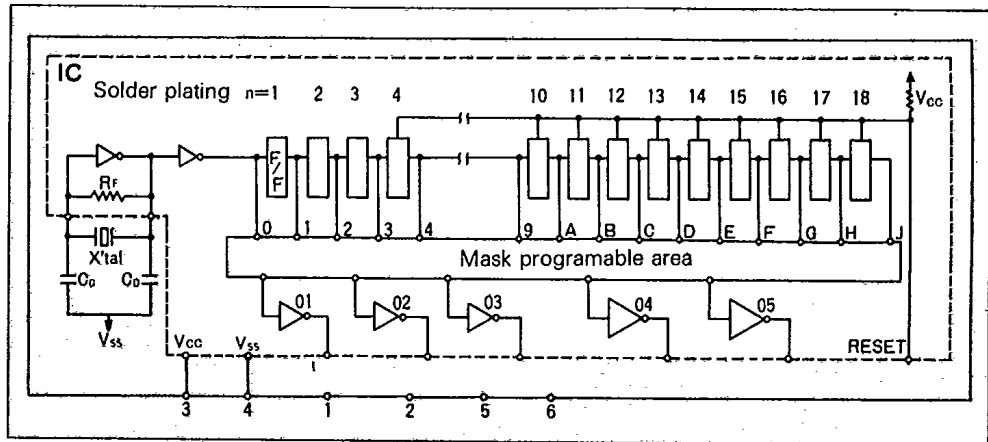

■ Sample Standard Mask (There are several other types)

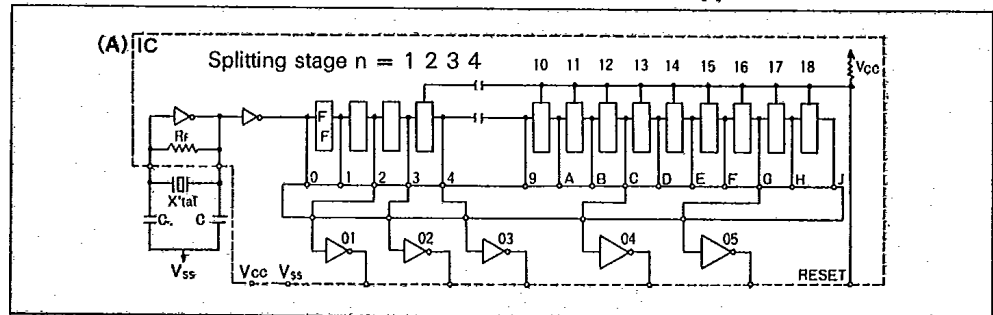

Number of Output (PIN No.)	(Output ratio) A = 10 steps B = 11 steps C = 12 steps G = 16 steps (reset effective starting with 4th step)
OUTPUT 1 (5)	0 1 2 3 4 5 6 7 8 9 A C Reset Possible
OUTPUT 2 1 6 (5)	0 0 0 1 1 1 1 1 2 2 2 2 3 3 3 3 4 4 4 4 4 4 5 5 6 6 7 7 7 8 1 2 C 2 7 8 9 C 3 4 5 C 4 5 6 8 C 5 6 7 8 A-C 7 A 8 8 9 A 9 Reset Possible
OUTPUT 1 6 (5)	0 1 1 2 2 3 3 3 4 4 4 4 5 5 6 7 7 8 9 A C G A G 6 G 6 A G 6 A B G 6 B A A B A A B G Reset Possible
OUTPUT 2 1 6 (5)	0 0 0 0 0 1 1 1 1 1 1 1 1 1 2 2 2 2 2 2 2 2 2 2 2 2 3 3 3 3 1 1 1 2 2 C 2 2 C 7 7 7 8 8 9 3 3 3 3 4 4 4 4 5 C 4 4 4 4 2 C G C G G C G G 8 9 A 9 A A 4 5 6 C G 5 6 C G 6 G 5 6 8 A Reset Possible
OUTPUT 2 1 6 (5)	3 3 3 3 3 4 4 4 4 4 4 4 4 4 5 5 5 6 7 7 7 7 8 4 4 5 6 8 C 5 5 5 6 6 7 7 8 A C 7 7 A 8 8 8 9 A 9 C G 6 8 A G 6 7 A B 8 A A B A B G A B B A 9 A A B A Reset Possible
OUTPUT 2 1 6 5	0 0 0 0 1 1 1 1 1 2 2 2 2 2 2 2 2 3 3 3 3 3 3 4 4 4 4 4 5 7 1 1 1 2 2 7 7 7 8 3 3 3 3 3 4 4 4 4 4 4 4 6 5 5 5 6 7 7 8 2 2 C C C 8 8 9 9 4 4 4 4 5 C 5 C 5 6 6 8 C 8 7 7 A 8 A A 9 C G G G G 9 A A A 5 6 C G 6 G 6 G 6 8 A A G A A B B A B B A

How to Order

LQV - M -

① ② ③ ④

- (1) Model Name
- (2) Source Oscillation Crystal Vibrator Frequency: 3 to 7 highest digits displayed
- (3) Frequency Step Code of Output Frequency
- (4) Frequency Step Code of Output Frequency or Reset Displayed

EXAMPLE

LQV-3M2768-3CGR

① ②③④⑤

- ① fo = 3.2768MHz ⑤ RESET
- ② fo/2³ = 409.6KHz
- ③ fo/2¹² = 800Hz
- ④ fo/2^{1⁰} = 50Hz

LQV-3M93216-1G

① ②③

- ① fo = 3.93216MHz
- ② fo/2¹ = 1.96608MHz
- ③ fo/2^{1⁰} = 60Hz

LQV-4M00-012

① ②③④

- ① fo = 4.00MHz
- ② fo/2⁰ = 4.00MHz
- ③ fo/2¹ = 2.00MHz
- ④ fo/2² = 1.00MHz

Frequency Splitting Code No.

n=	0	1	2	~	9	10	11	12	13	14	15	16	17	18	RESET
Code No.	0	1	2	~	9	A	B	C	D	E	F	G	H	J	R

Maximum Absolute Rating

Classification	Code	Rating	Unit
Voltage	Vcc	-0.3 to +7.0	V
Working Temperature	Topr	-35 to +85	°C
Storage Temperature	Tstg	-40 to +90	°C

Specifications

Classification		Code	Rating	Unit	Remarks
Output frequency		f _{out}	12 to 8M*1	Hz	Cosine Wave 50% Duty
Frequency precision		Δf/f (25°C)	0: ±10	ppm	
			1: ±50	ppm	
			2: ±100	ppm	
			3: ±0.2	%	
Frequency temperature characteristic		Δf/f (T)	±20Max	ppm	-10°C~+60°C range based on Ta=25°C, Vcc=5.0V
Voltage characteristic		Δf/f (Vcc)	±2 Typical	ppm/V	
Operating temperature range		Topr	-20 to +70	°C	
Voltage		Vcc	+5.0±0.5	V	DC
Current consumption (at no load)		Ic	0.5Max to 5.0Max*2	mA	
Output current	01, 02, 03	I _{OH}	-0.08Min	mA	Vcc=5.0V, V _{OH} =4.6V
		I _{OL}	0.51Min	mA	Vcc=5.0V, V _{OL} =0.4V
	04, 05	I _{OH}	-0.51Min	mA	Vcc=5.0V, V _{OH} =4.6V
		I _{OL}	0.51Min	mA	Vcc=5.0V, V _{OL} =0.4V
Fan Out		n	LS TTL 1 gate		

Note : 1. Output frequency can be freely selected by setting source oscillation crystal vibrator and frequency splitter stage.
2. Varies with combination of source frequency and output frequency.

Specifications

