

LR38585

Single-chip Driver IC for 270 k/320 k-pixel B/W CCDs with Dual-power-supply Operation

DESCRIPTION

The LR38585 is a CMOS single-chip driver IC which generates timing pulses for driving 270 k/320 k-pixel B/W CCD area sensors with a dual-power-supply operation, synchronous pulses for TV signals and processing pulses for video signals.

FEATURES

- Designed for 1/3-type 270 k/320 k-pixel B/W CCD area sensors with a dual-power-supply operation
- Switchable between EIA and CCIR modes
- Electronic shutter and EE control are possible
- Maximum shutter speed is selectable from approx. 1/100 000 s, 1/50 000 s and 1/30 000 s
- Starting shutter speed is selectable from approx. 1/100 000 s and 1/1 000 s
- Flicker-less function
- Switchable between normal and mirror images
- External synchronization is possible
- Level shifter for readout and shutter pulses included
- Dual +5 V and +12 V power supplies
- Package :
48-pin QFP (P-QFP048-0707) 0.5 mm pin-pitch



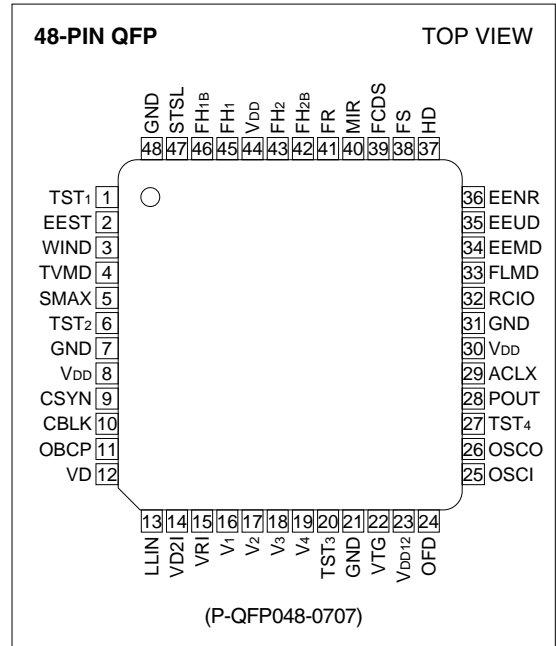

PIN CONNECTIONS

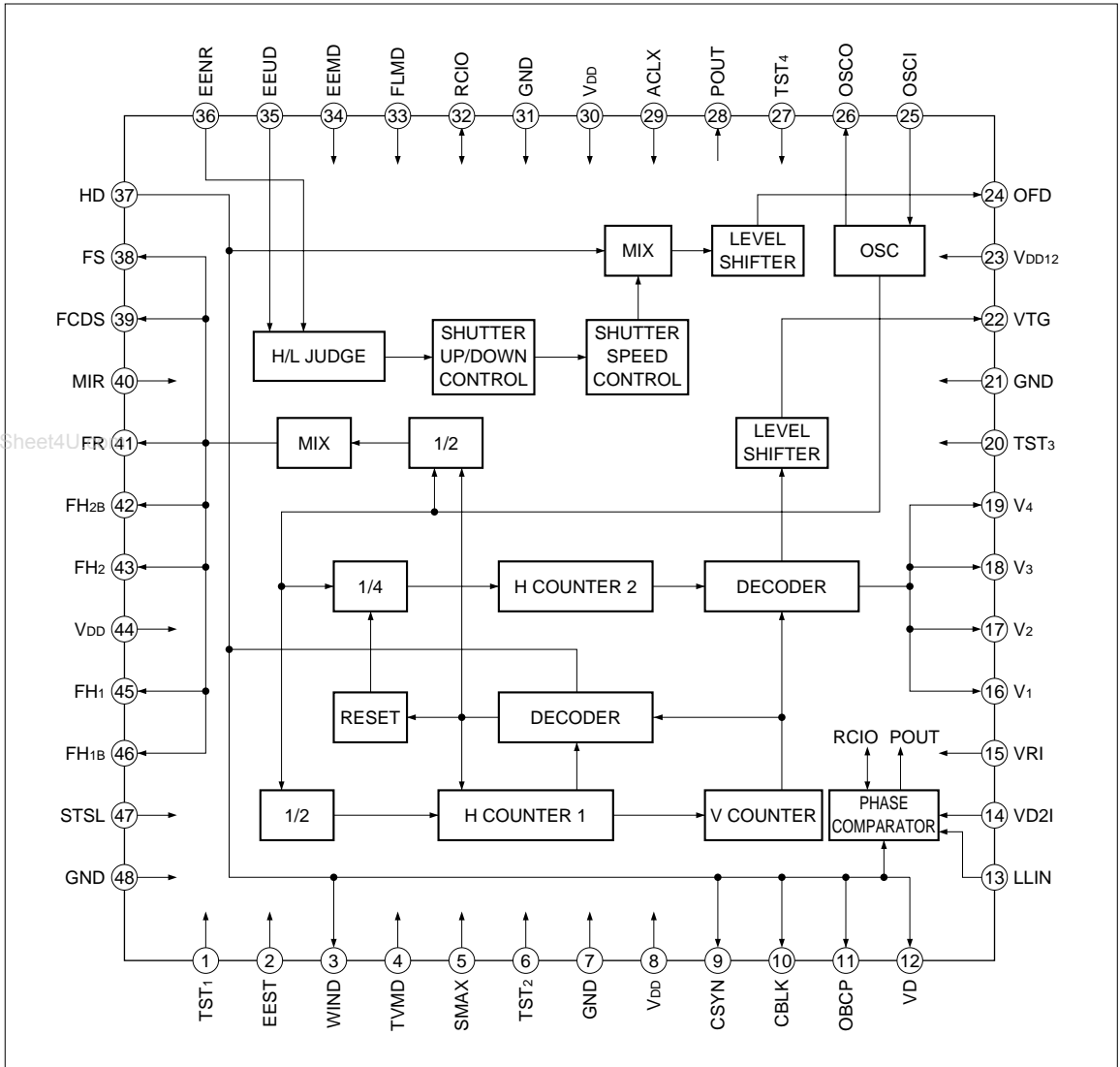







BLOCK DIAGRAM



PIN DESCRIPTION

PIN NO.	SYMBOL	IO SYMBOL	POLARITY	PIN NAME	DESCRIPTION																				
1	TST ₁	ICD	–	Test pin 1	A test pin. Set open or to L level in normal mode.																				
2	EEST	ICU	–	Electronic exposure control input 1	An input pin to control electronic exposure using EEUD (pin 35) and EENR (pin 36). L level : Electronic exposure is stopped. H level or open : Electronic exposure is operated.																				
3	WIND	ON (N-ch) Open (Drain)		Window pulse output	An output pin for window pulse. <table border="1" data-bbox="714 401 1226 574"> <thead> <tr> <th>FLMD</th> <th>EEMD</th> <th>WIND</th> </tr> </thead> <tbody> <tr> <td>L</td> <td>L</td> <td rowspan="2">WIND1 (vertical pulse)</td> </tr> <tr> <td>H</td> <td>L</td> </tr> <tr> <td>L</td> <td>H</td> <td rowspan="2">WIND2 (composite pulse)</td> </tr> <tr> <td>H</td> <td>H</td> </tr> </tbody> </table> WIND1 : When connected to EEST (pin 2), the operation of electronic exposure can be stopped at the upper side of monitor. WIND2 : A pulse that picks out the center of the CCD output. At this time, set H level or open at EEST (pin 2). As the output circuit of WIND is N-ch open drain, connected to V _{DD} with R (≥ 47 kΩ).	FLMD	EEMD	WIND	L	L	WIND1 (vertical pulse)	H	L	L	H	WIND2 (composite pulse)	H	H							
FLMD	EEMD	WIND																							
L	L	WIND1 (vertical pulse)																							
H	L																								
L	H	WIND2 (composite pulse)																							
H	H																								
4	TVMD	ICU	–	TV mode selection input	An input pin to select TV standards. L level : EIA mode H level or open : CCIR mode																				
5	SMAX	ICU	–	Shutter speed control input 1	An input pin to control maximum and initial shutter speed with STSL (pin 40). <table border="1" data-bbox="714 986 1226 1159"> <thead> <tr> <th>SMAX</th> <th>STSL</th> <th>Maximum Speed</th> <th>Initial Speed</th> </tr> </thead> <tbody> <tr> <td>H</td> <td>H</td> <td>≒ 1/ 30 000 s</td> <td>≒ 1/ 1 000 s</td> </tr> <tr> <td>L</td> <td>H</td> <td>≒ 1/ 49 000 s</td> <td>≒ 1/ 1 000 s</td> </tr> <tr> <td>H</td> <td>L</td> <td>≒ 1/100 000 s</td> <td>≒ 1/ 1 000 s</td> </tr> <tr> <td>L</td> <td>L</td> <td>≒ 1/100 000 s</td> <td>≒ 1/100 000 s</td> </tr> </tbody> </table>	SMAX	STSL	Maximum Speed	Initial Speed	H	H	≒ 1/ 30 000 s	≒ 1/ 1 000 s	L	H	≒ 1/ 49 000 s	≒ 1/ 1 000 s	H	L	≒ 1/100 000 s	≒ 1/ 1 000 s	L	L	≒ 1/100 000 s	≒ 1/100 000 s
SMAX	STSL	Maximum Speed	Initial Speed																						
H	H	≒ 1/ 30 000 s	≒ 1/ 1 000 s																						
L	H	≒ 1/ 49 000 s	≒ 1/ 1 000 s																						
H	L	≒ 1/100 000 s	≒ 1/ 1 000 s																						
L	L	≒ 1/100 000 s	≒ 1/100 000 s																						
6	TST ₂	ICD	–	Test pin 2	A test pin. Set open or to L level in normal mode.																				
7	GND	–	–	Ground	A grounding pin.																				
8	V _{DD}	–	–	Power supply	Supply of +5 V power.																				
9	CSYN	O		Composite synchronizing pulse output	An output pin of composite synchronous signal pulse.																				
10	CBLK	O		Composite blanking pulse output	An output pin of composite blanking pulse.																				
11	OBCP	O		Optical black clamp pulse output	A pulse to clamp the optical black signal. This pulse stays low during the absence of effective pixels within the vertical blanking.																				

PIN NO.	SYMBOL	IO SYMBOL	POLARITY	PIN NAME	DESCRIPTION						
12	VD	O		Vertical drive pulse output	The pulse occurs at the start of every field.						
13	LLIN	ICSU	-	Line-lock pulse input	An input pin for line-lock pulse. The priority is lower than VD2I (pin 14). The inner mono-multivibrator is operated by the falling-edge of LLIN. The width of mono-multivibrator output is determined by R and C which are connected with RCIO (pin 32).						
14	VD2I	ICSU	-	External VD pulse input	An input pin for external VD pulse. The priority is higher than LLIN (pin 13).						
15	VRI	ICSU	-	Vertical reset input	An input pin for resetting internal vertical counter. The input pulse is VSYNC (negative polarity).						
16	V ₁	O4MA2		Vertical transfer pulse output 1	A pulse to drive vertical CCD shift register. Connect to ϕ_{V1} pin of the CCD.						
17	V ₂	O4MA2		Vertical transfer pulse output 2	A pulse to drive vertical CCD shift register. Connect to ϕ_{V2} pin of the CCD.						
18	V ₃	O4MA2		Vertical transfer pulse output 3	A pulse to drive vertical CCD shift register. Connect to ϕ_{V3} pin of the CCD.						
19	V ₄	O4MA2		Vertical transfer pulse output 4	A pulse to drive vertical CCD shift register. Connect to ϕ_{V4} pin of the CCD.						
20	TST ₃	ICD	-	Test pin 3	A test pin. Set open or to L level in normal mode.						
21	GND	-	-	Ground	A grounding pin.						
22	VTG	O12MHV		Readout pulse output	A pulse that transfers the charge of the photo-diode to the vertical shift register. Connect to the VTG pin of the CCD.						
23	VDD12	-	-	Power supply	Supply of +12.5 V power.						
24	OFD	O12MHV		OFD pulse output	A pulse that sweeps the charge of the photo-diode for electronic shutter. Connect to OFD of the CCD. Held at L level in normal mode.						
25	OSCI	OSCI	-	Clock input	An input pin for reference clock oscillation. Connect to OSCO (pin 26) with R. The frequencies are as follows : <table border="1" data-bbox="710 1258 1225 1362"> <thead> <tr> <th>TVMD</th> <th>Frequency</th> </tr> </thead> <tbody> <tr> <td>L</td> <td>19.0699 MHz (1 212 fH)</td> </tr> <tr> <td>H</td> <td>19.3125 MHz (1 236 fH)</td> </tr> </tbody> </table> <p style="text-align: center;">fH = Horizontal frequency</p>	TVMD	Frequency	L	19.0699 MHz (1 212 fH)	H	19.3125 MHz (1 236 fH)
TVMD	Frequency										
L	19.0699 MHz (1 212 fH)										
H	19.3125 MHz (1 236 fH)										
26	OSCO	OSC3M	-	Clock output	An output pin for reference clock oscillation. The output is the inverse of OSCI (pin 25).						
27	TST ₄	ICD	-	Test pin 4	A test pin. Set open or to L level in normal mode.						

PIN NO.	SYMBOL	IO SYMBOL	POLARITY	PIN NAME	DESCRIPTION																				
28	POUT	TO6M	—	Phase comparator output	<p>An output pin of phase comparator. The pulse is generated by comparing the phase of the inner VSYNC pulse with mono-multivibrator output which is made from the falling edge of LLIN (pin 13) adjusted by mono-multivibrator or with the falling edge of VD2I (pin 14).</p> <table border="1"> <tr> <td>Advanced</td> <td>H level</td> </tr> <tr> <td>Delayed</td> <td>L level</td> </tr> <tr> <td>Same</td> <td>High-impedance</td> </tr> </table>	Advanced	H level	Delayed	L level	Same	High-impedance														
Advanced	H level																								
Delayed	L level																								
Same	High-impedance																								
29	ACLX	ICU	—	All clear input	An input pin for resetting all internal circuits at power-on. Connect V _{DD} through the diode and GND through the capacitor.																				
30	V _{DD}	—	—	Power supply	Supply of +5 V power.																				
31	GND	—	—	Ground	A grounding pin.																				
32	RCIO	IO0	—	Pulse width control output/input	<p>The pin for determining the width of the mono-multipulse to use LLIN (Line-locked circuit). To be connected R to V_{DD}, and C to GND. To be connected R (= 100 kΩ) to V_{DD} for input protection, when no use LLIN (Line-locked).</p>																				
33	FLMD	ICU	—	Electronic exposure and WIND pulse control input 1	<p>An input pin to control electronic exposure mode, flickerless mode and WIND (pin 3) pulse output.</p> <table border="1"> <tr> <th>FLMD</th> <th>EEMD</th> <th>Electronic Shutter Mode</th> <th>WIND</th> </tr> <tr> <td>L</td> <td>L</td> <td>EIA : 1/60 s, CCIR : 1/50 s</td> <td>WIND1</td> </tr> <tr> <td>H</td> <td>L</td> <td>EIA : 1/100 s, CCIR : 1/120 s</td> <td>WIND1</td> </tr> <tr> <td>L</td> <td>H</td> <td>E/E operation</td> <td>WIND1</td> </tr> <tr> <td>H</td> <td>H</td> <td>E/E operation</td> <td>WIND2</td> </tr> </table> <p>WIND1 : Vertical pulse WIND2 : Composite pulse (vertical and horizontal)</p>	FLMD	EEMD	Electronic Shutter Mode	WIND	L	L	EIA : 1/60 s, CCIR : 1/50 s	WIND1	H	L	EIA : 1/100 s, CCIR : 1/120 s	WIND1	L	H	E/E operation	WIND1	H	H	E/E operation	WIND2
FLMD	EEMD	Electronic Shutter Mode	WIND																						
L	L	EIA : 1/60 s, CCIR : 1/50 s	WIND1																						
H	L	EIA : 1/100 s, CCIR : 1/120 s	WIND1																						
L	H	E/E operation	WIND1																						
H	H	E/E operation	WIND2																						
34	EEMD	ICU	—	Electronic exposure and WIND pulse control input 2	An input pin to control electronic exposure mode, flickerless mode and WIND (pin 3) pulse output, used with FLMD (pin 33).																				
35	EEUD	IC	—	Electronic exposure control input 2	<p>An input pin to control electronic exposure.</p> <table border="1"> <tr> <th>EEUD</th> <th>EENR</th> <th>Shutter Speed</th> </tr> <tr> <td>H</td> <td>L</td> <td>up</td> </tr> <tr> <td>H</td> <td>H</td> <td>control stopped</td> </tr> <tr> <td>L</td> <td>H</td> <td>down</td> </tr> </table>	EEUD	EENR	Shutter Speed	H	L	up	H	H	control stopped	L	H	down								
EEUD	EENR	Shutter Speed																							
H	L	up																							
H	H	control stopped																							
L	H	down																							
36	EENR	IC	—	Electronic exposure control input 3																					
37	HD	O		Horizontal drive pulse output	The pulse occurs at the start of every line.																				
38	FS	O4MA2		CDS pulse output 1	A pulse to sample-hold the signal for the CCD.																				
39	FCDS	O4MA2		CDS pulse output 2	A pulse to clamp the feed-through level for the CCD.																				

PIN NO.	SYMBOL	IO SYMBOL	POLARITY	PIN NAME	DESCRIPTION																				
40	MIR	ICU	—	Mirror mode selection input	An input pin to select mirror image mode or normal image mode. L level : Normal image mode H level or open : Mirror image mode <table border="1" style="margin-left: 20px;"> <tr> <td>MIR</td> <td>L (Normal mode)</td> <td>H or open (Mirror mode)</td> </tr> <tr> <td>FH1B</td> <td>≐ FH1</td> <td>≐ FH2</td> </tr> <tr> <td>FH2B</td> <td>≐ FH2</td> <td>≐ FH1</td> </tr> </table>	MIR	L (Normal mode)	H or open (Mirror mode)	FH1B	≐ FH1	≐ FH2	FH2B	≐ FH2	≐ FH1											
MIR	L (Normal mode)	H or open (Mirror mode)																							
FH1B	≐ FH1	≐ FH2																							
FH2B	≐ FH2	≐ FH1																							
41	FR	O4MA3		Reset pulse output	A pulse to reset the charge of output circuit. Connect to φ _R pin of the CCD through the DC offset circuit.																				
42	FH2B	O4MA2		Horizontal transfer pulse output 2B	A pulse to drive horizontal CCD shift register. Connect to φ _{H2B} pin of the CCD.																				
43	FH2	O4MA3		Horizontal transfer pulse output 2	A pulse to drive horizontal CCD shift register. Connect to φ _{H2} pin of the CCD.																				
44	V _{DD}	—	—	Power supply	Supply of +5 V power.																				
45	FH1	O4MA3		Horizontal transfer pulse output 1	A pulse to drive horizontal CCD shift register. Connect to φ _{H1} pin of the CCD.																				
46	FH1B	O4MA2		Horizontal transfer pulse output 1B	A pulse to drive horizontal CCD shift register. Connect to φ _{H1B} pin of the CCD.																				
47	STSL	ICU	—	Shutter speed control input 2	An input pin to control maximum and initial shutter speed with SMAX (pin 37). <table border="1" style="margin-left: 20px;"> <thead> <tr> <th>SMAX</th> <th>STSL</th> <th>Maximum Speed</th> <th>Initial Speed</th> </tr> </thead> <tbody> <tr> <td>H</td> <td>H</td> <td>≐ 1/ 30 000 s</td> <td>≐ 1/ 1 000 s</td> </tr> <tr> <td>L</td> <td>H</td> <td>≐ 1/ 49 000 s</td> <td>≐ 1/ 1 000 s</td> </tr> <tr> <td>H</td> <td>L</td> <td>≐ 1/100 000 s</td> <td>≐ 1/ 1 000 s</td> </tr> <tr> <td>L</td> <td>L</td> <td>≐ 1/100 000 s</td> <td>≐ 1/100 000 s</td> </tr> </tbody> </table>	SMAX	STSL	Maximum Speed	Initial Speed	H	H	≐ 1/ 30 000 s	≐ 1/ 1 000 s	L	H	≐ 1/ 49 000 s	≐ 1/ 1 000 s	H	L	≐ 1/100 000 s	≐ 1/ 1 000 s	L	L	≐ 1/100 000 s	≐ 1/100 000 s
SMAX	STSL	Maximum Speed	Initial Speed																						
H	H	≐ 1/ 30 000 s	≐ 1/ 1 000 s																						
L	H	≐ 1/ 49 000 s	≐ 1/ 1 000 s																						
H	L	≐ 1/100 000 s	≐ 1/ 1 000 s																						
L	L	≐ 1/100 000 s	≐ 1/100 000 s																						
48	GND	—	—	Ground	A grounding pin.																				

NOTE : How to use ACLX pin (pin 29).

And how to use RCIO pin (pin 32), when the LLIN pin (Line-locked) is not used.

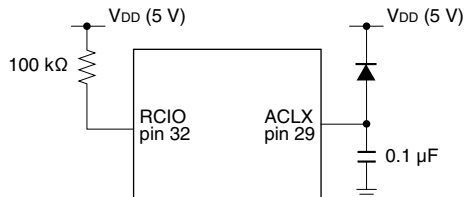

- IC : Input pin (CMOS level)
- ICU : Input pin (CMOS level with pull-up resistor)
- ICD : Input pin (CMOS level with pull-down resistor)
- ICSU : Input pin (CMOS schmitt-trigger level with pull-up resistor)
- IO0 : Input and output pin (CMOS level input and output)
- O : Output pin (V_{DD} = 5 V)

- O4MA2 : Output pin (V_{DD} = 5 V)
- O4MA3 : Output pin (V_{DD} = 5 V)
- O12MHV : Output pin (V_{DD12} = 12.5 V)
- ON : Output pin (N-ch open drain)
- TO6M : Tristate output pin
- OSCI : Input pin for oscillation
- OSC3M : Output pin for oscillation

SUPPLEMENTARY EXPLANATION

Shutter speed changes at electronic exposure control mode.

EIA				CCIR			
No.	Charge Time	Shutter Speed	Ratio	No.	Charge Time	Shutter Speed	Ratio
0	262H or 263H	$\approx 1/60$ s		0	312H or 313H	$\approx 1/50$ s	
1	259H + α	$\approx 1/61$ s	2.8 to 3.4%	1	309H + β	$\approx 1/51$ s	3.3 to 3.9%
•	(by 7H step)			•	(by 10H step)		
9	203H + α	$\approx 1/77$ s	2.5 to 3.0%	6	259H + β	$\approx 1/60$ s	2.8 to 3.4%
10	198H + α	$\approx 1/79$ s		7	252H + β	$\approx 1/62$ s	
•	(by 5H step)		2.4 to 3.0%	•	(by 7H step)		2.5 to 3.0%
15	173H + α	$\approx 1/91$ s		14	203H + β	$\approx 1/77$ s	
16	168H + α	$\approx 1/93$ s	2.3 to 3.1%	15	198H + β	$\approx 1/79$ s	2.4 to 3.0%
17	164H + α	$\approx 1/96$ s		•	(by 5H step)		
•	(by 4H step)		2.3 to 3.1%	21	168H + β	$\approx 1/93$ s	2.4 to 3.0%
24	136H + α	$\approx 1/115$ s		22	164H + β	$\approx 1/95$ s	
25	132H + α	$\approx 1/119$ s	2.1 to 3.3%	•	(by 4H step)		2.3 to 3.1%
26	129H + α	$\approx 1/122$ s		30	132H + β	$\approx 1/118$ s	
•	(by 3H step)		2.1 to 3.3%	31	129H + β	$\approx 1/121$ s	2.1 to 3.3%
36	99H + α	$\approx 1/158$ s		•	(by 3H step)		
37	96H + α	$\approx 1/163$ s	1.7 to 9.6%	42	96H + β	$\approx 1/162$ s	1.7 to 9.6%
38	94H + α	$\approx 1/167$ s		43	94H + β	$\approx 1/166$ s	
•	(by 2H step)		1.6 to 5%	•	(by 2H step)		1.6 to 5%
55	60H + α	$\approx 1/261$ s		60	60H + β	$\approx 1/259$ s	
56	59H + α	$\approx 1/265$ s	2.9 to 4.6%	61	59H + β	$\approx 1/263$ s	2.9 to 4.6%
•	(by 1H step)			•	(by 1H step)		
99	16H + α	$\approx 1/960$ s	5 to 9%	104	16H + β	$\approx 1/955$ s	5 to 9%
100	15H + α	$\approx 1/1020$ s		105	15H + β	$\approx 1/1020$ s	
•	(by 1H step)		2.9 to 4.6%	•	(by 1H step)		2.9 to 4.6%
105	10H + α	$\approx 1/1520$ s		110	10H + β	$\approx 1/1510$ s	
106	t106n	$\approx 1/1540$ s	5 to 9%	111	t111n	$\approx 1/1530$ s	5 to 9%
•				•			
230	t230n	$\approx 1/29000$ s	2.9 to 4.6%	237	t237n	$\approx 1/29100$ s	2.9 to 4.6%
231	t231n	$\approx 1/29800$ s		238	t238n	$\approx 1/29900$ s	
•			5 to 9%	•			5 to 9%
244	t244n	$\approx 1/47000$ s		251	t251n	$\approx 1/46900$ s	
245	t245n	$\approx 1/49150$ s	2.9 to 4.6%	252	t252n	$\approx 1/49020$ s	2.9 to 4.6%
•				•			
255	t255n	$\approx 1/91680$ s	5 to 9%	262	t262n	$\approx 1/90250$ s	5 to 9%
256	t256n	$\approx 1/100370$ s		263	t263n	$\approx 1/98600$ s	

$$\alpha = 0.360H$$

$$\beta = 0.353H$$

Select maximum shutter speed and initial shutter speed.

SMAX	STSL	MAXIMUM SHUTTER SPEED (s)				INITIAL SHUTTER SPEED (s)			
		Pin 5	Pin 47	Step	Ratio	Step	Ratio	Step	Ratio
H	H	231	$\approx 1/29800$	238	$\approx 1/29900$	100	$\approx 1/1020$	105	$\approx 1/1020$
L	H	245	$\approx 1/49150$	252	$\approx 1/49020$	100	$\approx 1/1020$	105	$\approx 1/1020$
H	L	256	$\approx 1/100370$	263	$\approx 1/98600$	100	$\approx 1/1020$	105	$\approx 1/1020$
L	L	256	$\approx 1/100370$	263	$\approx 1/98600$	256	$\approx 1/100370$	263	$\approx 1/98600$

ABSOLUTE MAXIMUM RATINGS

PARAMETER	SYMBOL	RATING	UNIT
Supply voltage	V _{DD}	-0.3 to +6.0	V
	V _{DD12}	-0.3 to +15.0	V
Input voltage	V _I	-0.3 to V _{DD} + 0.3	V
Output voltage	V _O	-0.3 to V _{DD} + 0.3	V
	V _{O12}	-0.3 to V _{DD12} + 0.3	V
Operating temperature	T _{OPR}	-20 to +70	°C
Storage temperature	T _{STG}	-55 to +150	°C

ELECTRICAL CHARACTERISTICS

DC Characteristics

(V_{DD} = 5.0±0.5 V, V_{DD12} = 12.5±0.5 V, T_{OPR} = -20 to +70°C)

PARAMETER	SYMBOL	CONDITIONS	MIN.	TYP.	MAX.	UNIT	NOTE
Input "Low" voltage	V _{IL}				1.5	V	1
Input "High" voltage	V _{IH}		3.5			V	
Input "Low" voltage	V _{T+}				3.7	V	2
Input "High" voltage	V _{T-}		1.0			V	
Hysteresis voltage	V _{T+} - V _{T-}		0.2			V	
Input "Low" current	I _{IL1}	V _I = 0 V			2.0	μA	3
Input "High" current	I _{IH1}	V _I = V _{DD}			2.0	μA	
Input "Low" current	I _{IL2}	V _I = 0 V			2.0	μA	4
Input "High" current	I _{IH2}	V _I = V _{DD}	8.0		60	μA	
Input "Low" current	I _{IL3}	V _I = 0 V	8.0		60	μA	5
Input "High" current	I _{IH3}	V _I = V _{DD}			2.0	μA	
Output "Low" voltage	V _{OL1}	I _{OL} = 4 mA			0.4	V	6
Output "High" voltage	V _{OH1}	I _{OH} = -2 mA	4.0			V	
Output "Low" voltage	V _{OL2}	I _{OL} = 3 mA			0.4	V	7
Output "High" voltage	V _{OH2}	I _{OH} = -3 mA	4.0			V	
Output "Low" voltage	V _{OL3}	I _{OL} = 8 mA			0.4	V	8
Output "High" voltage	V _{OH3}	I _{OH} = -6 mA	4.0			V	
Output "Low" voltage	V _{OL4}	I _{OL} = 12 mA			0.4	V	9
Output "High" voltage	V _{OH4}	I _{OH} = -9 mA	4.0			V	
Output "Low" voltage	V _{OL5}	I _{OL} = 12 mA			0.5	V	10
Output "High" voltage	V _{OH5}	I _{OH} = -12 mA	11.5			V	
Output "Low" voltage	V _{OL6}	I _{OL} = 4 mA			0.4	V	11
Output "Low" voltage	V _{OL7}	I _{OL} = 6 mA			0.4	V	
Output "High" voltage	V _{OH7}	I _{OH} = -3 mA	4.0			V	12
Output leakage current	I _{OZ}	High-Z			1.0	μA	

NOTES :

- Applied to inputs (IC, ICD, ICSU, OSC1).
- Applied to input (ICSU).
- Applied to inputs (IC, OSC1, IO0).
- Applied to input (ICD).
- Applied to inputs (ICU, ICSU).
- Applied to output (O, IO0).
- Applied to output (OSC3M). (Output (OSC3M) measures on condition that input (OSCI) level is 0 V or V_{DD}).
- Applied to output (O4MA2).
- Applied to output (O4MA3).
- Applied to output (O12MHV).
- Applied to output (ON).
- Applied to output (TO6M).

PACKAGE OUTLINES

48 QFP (P-QFP048-0707)

(Unit : mm)

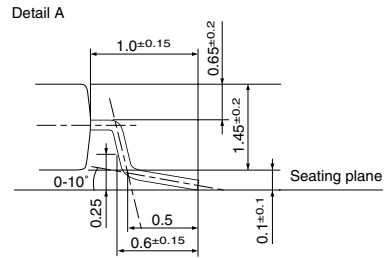
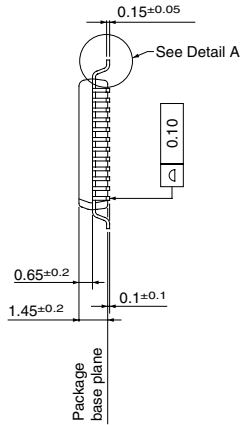
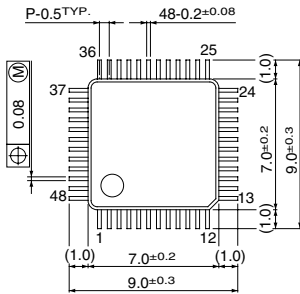

www.DataSheet4U.com