

LINEAR INTEGRATED CIRCUITS



FREQUENCY COMPENSATED OPERATIONAL AMPLIFIERS

- LOW OFFSET CURRENT AND VOLTAGE
- LOW INPUT CURRENT
- GUARANTEED DRIFT CHARACTERISTICS

The LS 107 series consists of general purpose operational amplifiers, with the frequency compensation built into the chip. They replace pin-to-pin the LS 709, LS 101, LS 141 and LS 148. The LS 107 series offers features similar to the LS 101A, providing better accuracy and lower noise in high impedance circuits. The low input currents allow the device to be used in slow charge applications, such as long interval integrators, slow ramps, sample and hold circuits. The LS 107 series is available with hermetic gold chip (8000 series), particularly suitable for professional and telecom applications, wherever very high MTBF are required.

| ABSOLUTE MAXIMUM RATINGS | | TO-99 | Minidip | μ package |
|--------------------------|---|---------------|---|-----------------------------|
| V_s | Supply voltage for LS 107 and LS 207 for LS 307 | | $\pm 22V$ $\pm 18V$ | |
| V_i (1) | Input voltage | | $\pm 15V$ | |
| ΔV_i | Differential input voltage | | $\pm 30V$ | |
| T_{op} | Operating temperature for LS 107 for LS 207 for LS 307 | | -55 to 125 °C -25 to 85 °C 0 to 70 °C | |
| | Output short circuit duration (2) | | indefinite | |
| P_{tot} | Power dissipation at $T_{amb} = 70^\circ C$ | 520 mW | 665 mW | 400 mW |
| T_{stg} | Storage temperature | -65 to 150 °C | -55 to 150 °C | -55 to 150 °C |
| | Lead soldering temperature | 300 °C (10s) | 260 °C (12s) | 260 °C (5s) 235 °C (11s) |

- 1) For supply voltages less than $\pm 15V$, input voltage is equal to the supply voltage
- 2) The short circuit duration is limited by thermal dissipation

MECHANICAL DATA

Dimensions in mm

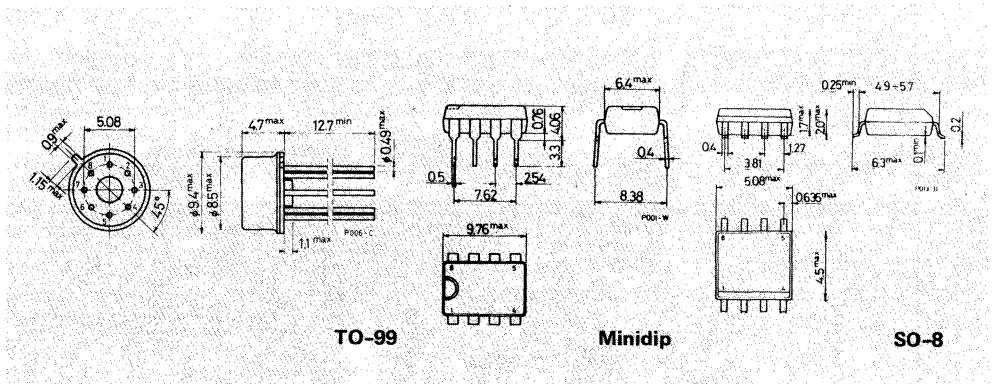



LS107
LS207
LS307

CONNECTION DIAGRAMS AND ORDERING NUMBERS

(top views)

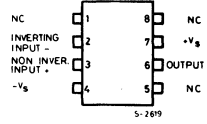
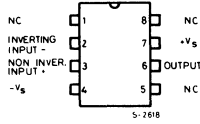
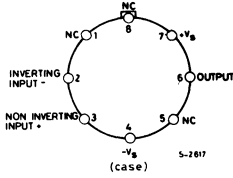

| Type | TO-99 | Minidip | SO-8 |
|---------|---------|---------|----------|
| LS 107 | LS 107T | — | — |
| LS 207 | LS 207T | — | — |
| LS 307 | LS 307T | LS 307B | LS 307M |
| LS 8107 | — | — | LS 8107M |
| LS 8207 | — | — | LS 8207M |
| LS 8307 | — | — | LS 8307M |

SCHEMATIC DIAGRAM

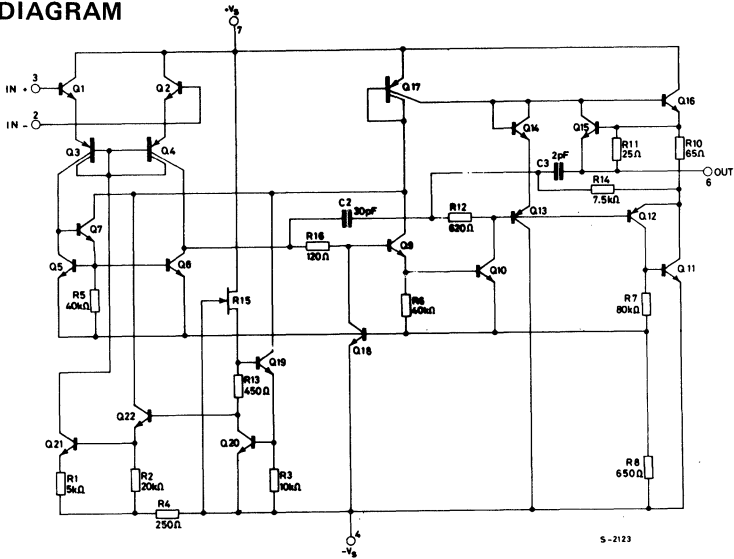

THERMAL DATA

| | TO-99 | Minidip | SO-8 | |
|--|-------|----------|----------|-----------|
| $R_{th j-amb}$ Thermal resistance junction-ambient | max | 155 °C/W | 120 °C/W | 200* °C/W |

* Measured with the device mounted on a ceramic substrate (25x16x0.6 mm)

ELECTRICAL CHARACTERISTICS (see note)

| Parameter | Test conditions | LS 107/LS 207 | | | LS 307 | | | Unit |
|--|--|---------------|----------|------|----------|----------|------|------------------------------|
| | | Min. | Typ. | Max. | Min. | Typ. | Max. | |
| V_{os} Input offset voltage | $R_g \leq 10 \text{ k}\Omega$ $R_g \leq 10 \text{ k}\Omega$ $T_{amb} = 25^\circ\text{C}$ | | | 3 | | | 10 | mV |
| | | | 0.7 | 2 | | 2 | 7.5 | mV |
| $\frac{\Delta V_{os}}{\Delta T}$ Average temperature coefficient of input offset voltage | | | 3 | 15 | | 6 | 30 | $\mu\text{V}/^\circ\text{C}$ |
| I_{os} Input offset current | $T_{amb} = 25^\circ\text{C}$ | | | 20 | | | 70 | nA |
| | | | 1.5 | 10 | | 3 | 50 | nA |
| $\frac{\Delta I_{os}}{\Delta T}$ Average temperature coefficient of input offset current | $T_{amb} = 25^\circ\text{C}$ to T_{max} $T_{amb} = T_{min}$ to 25°C | | 0.01 | 0.1 | | 0.01 | 0.3 | nA/ $^\circ\text{C}$ |
| | | | 0.02 | 0.2 | | 0.02 | 0.6 | nA/ $^\circ\text{C}$ |
| I_b Input bias current | $T_{amb} = 25^\circ\text{C}$ | | | 100 | | | 300 | nA |
| | | | 30 | 75 | | 70 | 250 | nA |
| R_i Input resistance | $T_{amb} = 25^\circ\text{C}$ | 1.5 | 4 | | 0.5 | 2 | | M Ω |
| G_v Large signal voltage gain | $V_s = \pm 15\text{V}$ $V_o = \pm 10\text{V}$ $R_L \geq 2 \text{ k}\Omega$ | | | | | | | |
| | $V_s = \pm 15\text{V}$ $V_o = \pm 10\text{V}$ $R_L \geq 2 \text{ k}\Omega$ $T_{amb} = 25^\circ\text{C}$ | 88 | | | 84 | | | |
| V_i Input voltage range | $V_s = \pm 20\text{V}$ $V_s = \pm 15\text{V}$ | | ± 15 | | | | | V |
| | | | | | ± 12 | | | V |
| V_o Output voltage swing | $V_s = \pm 15\text{V}$ $R_L = 10 \text{ k}\Omega$ $V_s = \pm 15\text{V}$ $R_L = 2 \text{ k}\Omega$ | ± 12 | ± 14 | | ± 12 | ± 14 | | V |
| | | ± 10 | ± 13 | | ± 10 | ± 13 | | V |
| CMR Common mode rejection | $R_g \leq 10 \text{ k}\Omega$ | 80 | 96 | | 70 | 90 | | dB |
| SVR Supply voltage rejection | $R_g \leq 10 \text{ k}\Omega$ | 80 | 96 | | 70 | 96 | | dB |
| I_s Supply current | $V_s = \pm 20\text{V}$ $T_{amb} = 25^\circ\text{C}$ $T_{amb} = 125^\circ\text{C}$ $V_s = \pm 15\text{V}$ $T_{amb} = 25^\circ\text{C}$ | | 1.8 | 3 | | | | mA |
| | | | 1.2 | 2.5 | | 1.8 | 3 | mA |

Note: These specifications, unless otherwise specified, apply for $V_s = \pm 5\text{V}$ to $\pm 20\text{V}$ and $T_{amb} = -55$ to 125°C for LS 107; $V_s = \pm 5\text{V}$ to $\pm 20\text{V}$ and $T_{amb} = -25$ to 85°C for LS 207; $V_s = \pm 5\text{V}$ to $\pm 15\text{V}$ and $T_{amb} = 0$ to 70°C for LS 307.

Fig. 1 - Supply current vs. supply voltage

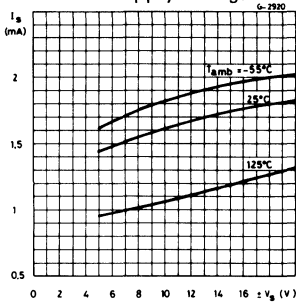

Fig. 2 - Voltage gain vs. supply voltage

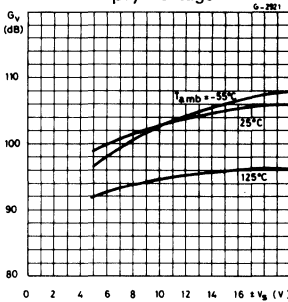

Fig. 3 - Input current vs. ambient temp.

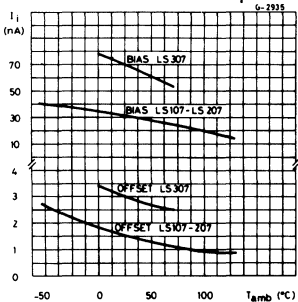

Fig. 4 - Current limiting vs. output current

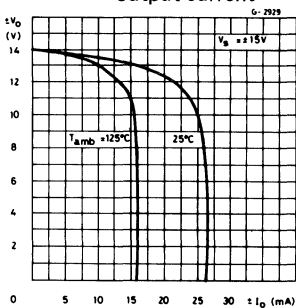

Fig. 5 - Input noise voltage vs. frequency

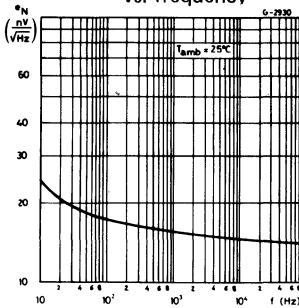

Fig. 6 - Input noise current vs. frequency

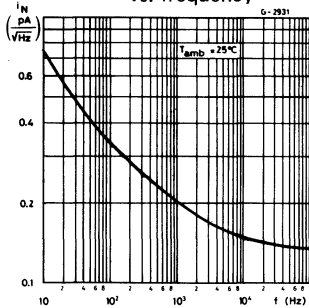

Fig. 7 - Open loop frequency response

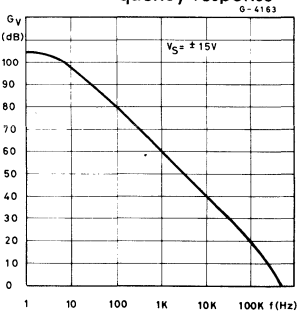

Fig. 8 - Large signal frequency response

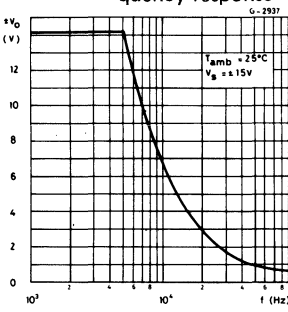
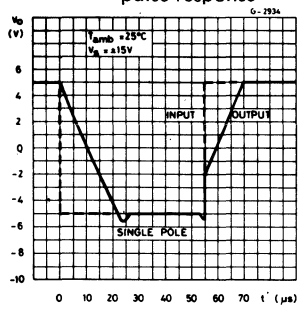

Fig. 9 - Voltage follower pulse response



Guaranteed performance characteristics (LS 107/LS 207)

Fig. 10 - Input voltage range vs. supply voltage

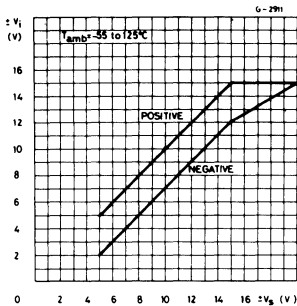

Fig. 11 - Output voltage swing vs. supply voltage

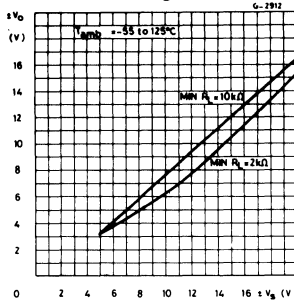
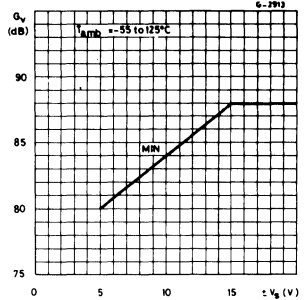

Fig. 12 - Voltage gain vs. supply voltage



Guaranteed performance characteristics (LS 307)

Fig. 13 - Input voltage range vs. supply voltage

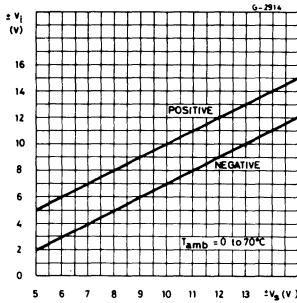

Fig. 14 - Output voltage swing vs. supply voltage

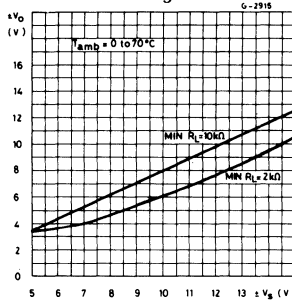
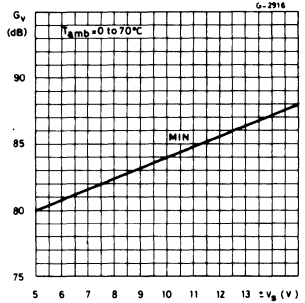

Fig. 15 - Voltage gain vs. supply voltage



TYPICAL APPLICATIONS

Fig. 16 - Inverting amplifier

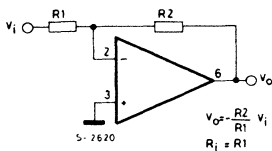

Fig. 17 - Non-inverting AC amplifier

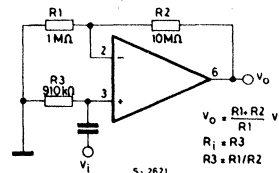

Fig. 18 - Non-inverting amplifier

