



LS101
LS201
LS301

LINEAR INTEGRATED CIRCUITS

HIGH PERFORMANCE OPERATIONAL AMPLIFIERS

- GUARANTED DRIFT CHARACTERISTICS
- SLEW RATE OF $10V/\mu s$ AS A SUMMING AMPLIFIER
- UNITY GAIN PHASE COMPENSATION WITH A SINGLE 30 pF CAPACITOR
- 3 mV MAX OFFSET VOLTAGE OVER TEMPERATURE RANGE
- 100 nA MAX INPUT BIAS CURRENT OVER TEMPERATURE RANGE

The LS 101 series consists of high performance operational amplifiers, intended for a wide range of analog applications, where tailoring of frequency characteristics is desirable. The LS 101 series is short circuit protected and has the same pin configuration as the LS 141 and LS 148. Absence of latch-up and high common mode voltage range make the LS 101 series ideal for use as voltage followers. In addition, the LS 101 series provides better accuracy and lower noise in high impedance circuitry: the low input current also makes it particularly well suited for long interval integrators, timers, sample and hold circuits and low frequency generators. The LS 101 series is also available with hermetic gold chip (8000 series), particularly suitable for professional and telecom applications, wherever very high MTBF are required.

ABSOLUTE MAXIMUM RATINGS		TO-99	Minidip	μ package
V_s	Supply voltage for LS 101/101A/201/201A for LS 301A		$\pm 22 V$ $\pm 18 V$	
V_i (1)	Input voltage		$\pm 15 V$ $\pm 30 V$	
ΔV_i	Differential input voltage			
T_{op}	Operating temperature for LS 101/LS 101A for LS 201A for LS 201/LS 301A		-55 to 125 °C -25 to 85 °C 0 to 70 °C indefinite	
P_{tot}	Output short circuit duration (2)	520 mW	665 mW	400 mW
T_{stg}	Power dissipation at $T_{amb} = 70^\circ C$ Storage temperature	-65 to 150 °C	-55 to 150 °C	-55 to 150 °C

(1) For supply voltage less than $\pm 15V$, input voltage is equal to the supply voltage.

(2) The short circuit duration is limited by thermal dissipation.

MECHANICAL DATA

Dimensions in mm

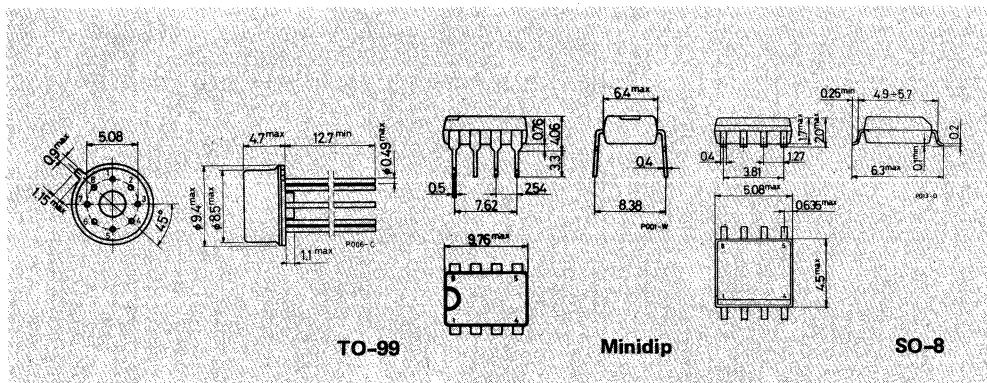

CONNECTION DIAGRAMS AND ORDERING NUMBERS
(top views)

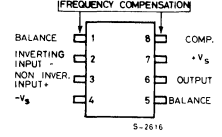
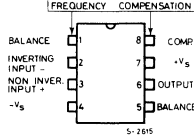
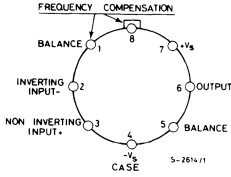

Type	TO-99	Minidip	SO-8
LS 101	LS 101T	—	—
LS 101A	LS 101AT	—	—
LS 201	LS 201T	LS 201B	LS 201M
LS 201A	LS 201AT	—	—
LS 301A	LS 301AT	LS 301AB	LS 301AM
LS 8101	—	—	LS 8101M
LS 8101A	—	—	LS 8101AM
LS 8201	—	—	LS 8201M
LS 8201A	—	—	LS 8201AM
LS 8301A	—	—	LS 8301AM

SCHEMATIC DIAGRAM

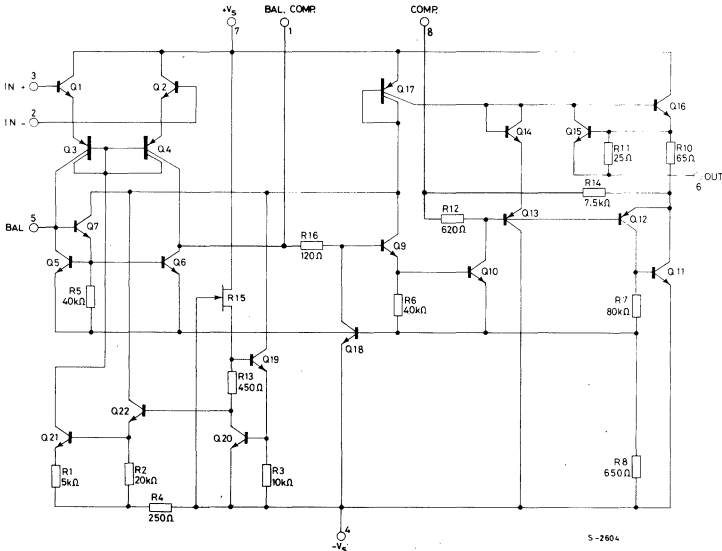



LS101
LS201
LS301

THERMAL DATA

THERMAL DATA			TO-99	Minidip	SO-8
$R_{th\ j-amb}$	Thermal resistance junction-ambient	max	155 °C/W	120 °C/W	200* °C/W

* Measured with the device mounted on a ceramic substrate (25x16x0.6 mm)

ELECTRICAL CHARACTERISTICS* for LS 101 and LS 201

Parameter	Test conditions	LS 101			LS 201			Unit
		Min.	Typ.	Max.	Min.	Typ.	Max.	
V_{os} Input offset voltage	$R_g \leq 10\ k\Omega$ $R_g \leq 10\ k\Omega$ $T_{amb} = 25^\circ C$		1	6 5		2	10 7.5	mV mV
$\frac{\Delta V_{os}}{\Delta T}$ Average temperat. coefficient of input offset voltage	$R_g \leq 10\ k\Omega$ $R_g \leq 50\Omega$		6 3			10 6		$\mu V/^\circ C$ $\mu V/^\circ C$
I_{os} Input offset current	$T_{amb} = 25^\circ C$ $T_{amb} = T_{max}$ $T_{amb} = T_{min}$		40 10 100	200 200 500		100 50 150	500 400 750	nA nA nA
I_b Input bias current	$T_{amb} = 25^\circ C$		0.12	1.5 0.5		0.25	2 1.5	μA μA
R_i Input resistance	$T_{amb} = 25^\circ C$	0.3	0.8		0.1	0.4		M Ω
V_i Input voltage range	$V_s = \pm 15V$	± 12			± 12			V
G_v Large signal voltage gain	$V_s = \pm 15V$ $V_o = \pm 10V$ $R_L \geq 2\ k\Omega$	88			83			dB
	$V_s = \pm 15V$ $V_o = \pm 10V$ $R_L \geq 2\ k\Omega$ $T_{amb} = 25^\circ C$	94	104		86	103		dB
CMR Common mode rejection	$R_g \leq 10\ k\Omega$	70	90		65	90		dB
SVR Supply voltage rejection	$R_g \leq 10\ k\Omega$	70	90		70	90		dB
V_o Output voltage swing	$V_s = \pm 15V$ $R_L = 10\ k\Omega$ $R_L = 2\ k\Omega$	± 12	± 14		± 12	± 14		V
		± 10	± 13		± 10	± 13		V
I_s Supply current	$V_s \pm 20V$		1.8	3		1.8	3	mA

* These specifications, unless otherwise specified, apply for $C_1 = 30\ pF$, $V_s = \pm 5$ to $\pm 20V$ and $T_{amb} = -55$ to $125^\circ C$ (LS 101/LS 101A), $T_{amb} = -25$ to $85^\circ C$ (LS 201A) and $T_{amb} = 0$ to $70^\circ C$ (LS 201); $V_s = \pm 5$ to $\pm 15V$ and $T_{amb} = 0$ to $70^\circ C$ (LS 301A).

ELECTRICAL CHARACTERISTICS* for LS 101A, LS 201A and LS 301A

Parameter	Test conditions	LS 101A/LS 201A			LS 301A			Unit
		Min.	Typ.	Max.	Min.	Typ.	Max.	
V_{OS} Input offset voltage	$R_g \leq 10 \text{ k}\Omega$ $R_g \leq 10 \text{ k}\Omega$ $T_{amb} = 25^\circ\text{C}$		0.7	3 2		2	10 7.5	mV mV
$\frac{\Delta V_{OS}}{\Delta T}$ Average temperat. coefficient of input offset voltage	$R_g \leq 10 \text{ k}\Omega$		3	15		6	30	$\mu\text{V}/^\circ\text{C}$
I_{OS} Input offset current	$T_{amb} = 25^\circ\text{C}$		1.5	20 10		3	70 50	nA nA
$\frac{\Delta I_{OS}}{\Delta T}$ Average temperat. coefficient of input offset current	$T_{amb} = 25^\circ\text{C}$ to T_{max} $T_{amb} = T_{min}$ to 25°C		0.01 0.02	0.1 0.2		0.01 0.02	0.3 0.6	nA/ $^\circ\text{C}$ nA/ $^\circ\text{C}$
I_b Input bias current	$T_{amb} = 25^\circ\text{C}$		30	0.1 75		70	0.3 250	μA nA
R_i Input resistance	$T_{amb} = 25^\circ\text{C}$	1.5	4		0.5	2		M Ω
V_i Input voltage range	$V_s = \pm 20\text{V}$ $V_s = \pm 15\text{V}$	± 15				± 12		V V
G_v Large signal voltage gain	$V_s = \pm 15\text{V}$ $V_o = \pm 10\text{V}$ $R_L \geq 2 \text{ k}\Omega$	88			83			dB
	$V_s = \pm 15\text{V}$ $V_o = \pm 10\text{V}$ $R_L \geq 2 \text{ k}\Omega$ $T_{amb} = 25^\circ\text{C}$	94	104		86	104		dB
CMR Common mode rejection	$R_g \leq 10 \text{ k}\Omega$	80	96		70	90		dB
SVR Supply voltage rejection	$R_g \leq 10 \text{ k}\Omega$	80	96		70	96		dB
V_o Output voltage swing	$V_s = \pm 15\text{V}$ $R_L = 10 \text{ k}\Omega$ $R_L = 2 \text{ k}\Omega$	± 12 ± 10	± 14 ± 13		± 12 ± 10	± 14 ± 13		V V
I_s Supply current	$V_s = \pm 20\text{V}$ $T_{amb} = T_{max}$ $T_{amb} = 25^\circ\text{C}$		1.2	2.5				mA
	$V_s = \pm 20\text{V}$ $V_s = \pm 15\text{V}$		1.8	3		1.8	3	mA mA

* These specifications, unless otherwise specified, apply for $C_1 = 30 \text{ pF}$, $V_s = \pm 5$ to $\pm 20\text{V}$ and $T_{amb} = -55$ to 125°C (LS 101/LS 101A), $T_{amb} = -25$ to 85°C (LS 201A) and $T_{amb} = 0$ to 70°C (LS 201); $V_s = \pm 5$ to $\pm 15\text{V}$ and $T_{amb} = 0$ to 70°C (LS 301A).



LS 101
LS 201
LS 301

Guaranteed characteristics (LS 101/LS 201)

Fig. 1 - Input voltage range vs. supply voltage

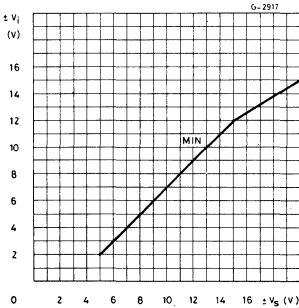

Fig. 2 - Output voltage swing vs. supply voltage

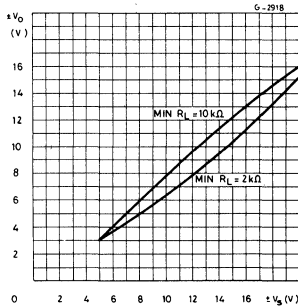
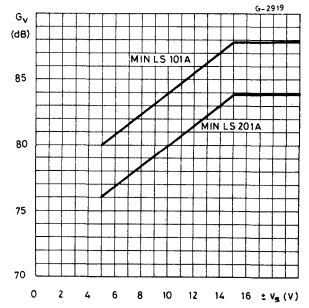

Fig. 3 -- Voltage gain vs. supply voltage



Guaranteed characteristics (LS 101A/LS 201A)

Fig. 4 - Input voltage range vs. supply voltage

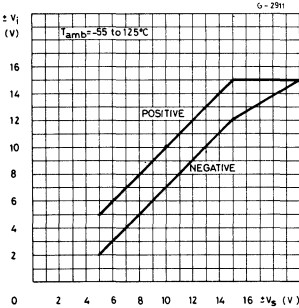

Fig. 5 - Output voltage swing vs. supply voltage

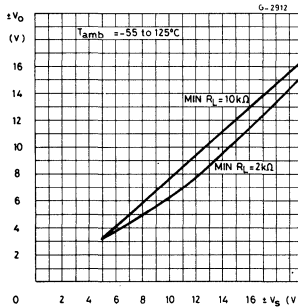
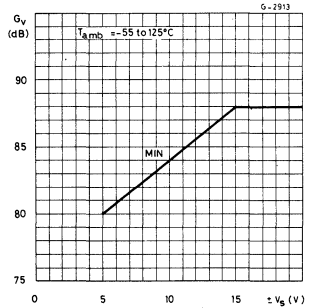

Fig. 6 - Voltage gain vs. supply voltage



Guaranteed characteristics (LS 301A)

Fig. 7 - Input voltage range vs. supply voltage

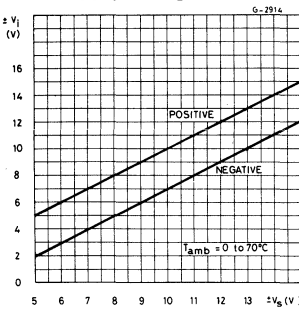

Fig. 8 - Output voltage swing vs. supply voltage

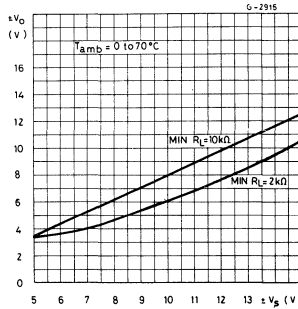

Fig. 9 - Voltage gain vs. supply voltage

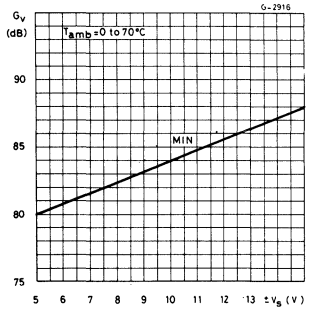

Fig. 10 - Input bias current vs. ambient temperature (for LS 101A/201A/301A)

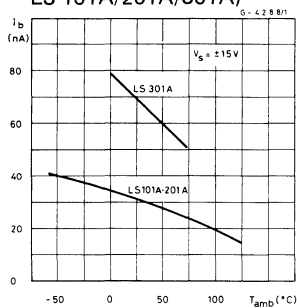

Fig. 11 - Input offset current vs. ambient temperature (for LS 101A/201A/301A)

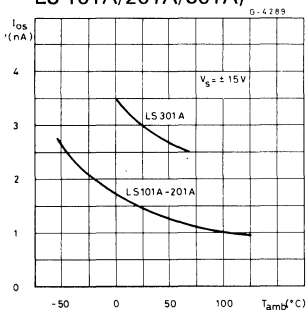

Fig. 12 - Input bias current vs. ambient temperature (for LS 101/201)

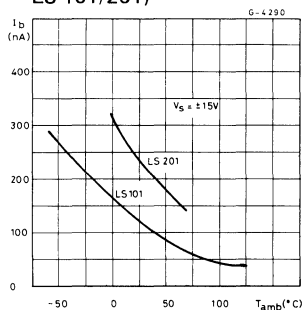

Fig. 13 - Input offset current vs. ambient temperature (for LS 101/201)

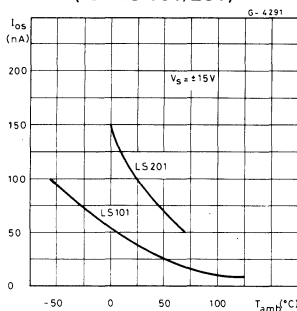

Fig. 14 - Supply current vs. supply voltage

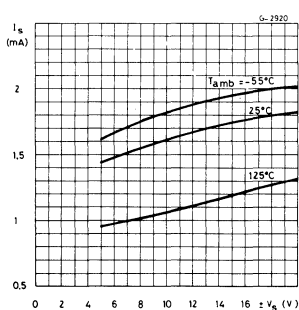

Fig. 15 - Voltage gain vs. supply voltage

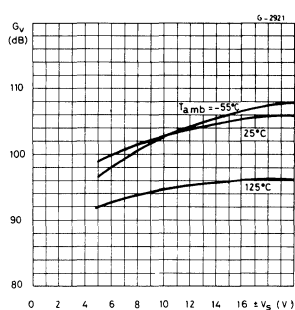

Fig. 16 - Output voltage swing vs. output current

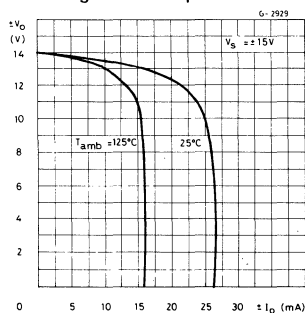

Fig. 17 - Input noise voltage vs. frequency

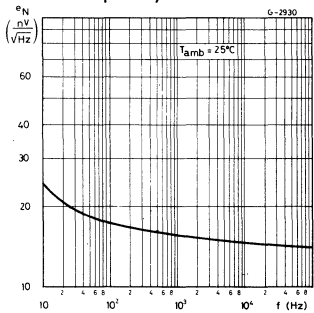
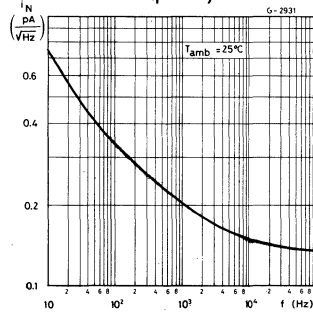

Fig. 18 - Input noise current vs. frequency





LS101
LS201
LS301

OPERATIONAL AMPLIFIER COMPENSATION

SINGLE POLE

Fig. 19

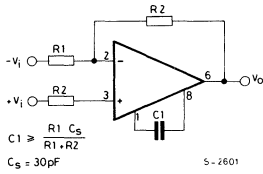

Fig. 20 - Open loop frequency response

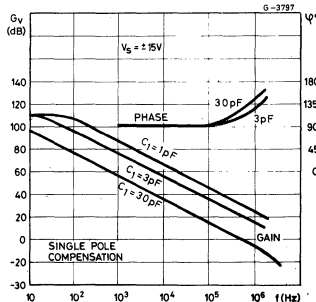
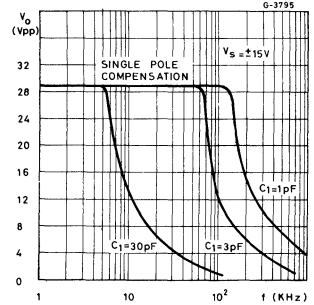

Fig. 21 - Large signal frequency response



TWO POLE

Fig. 22

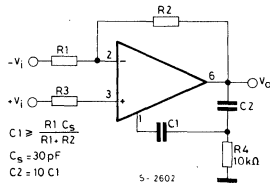

Fig. 23 - Open loop frequency response

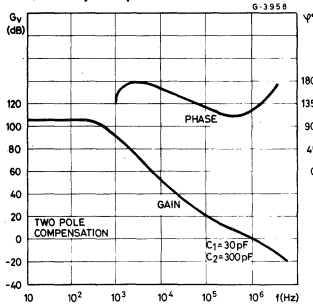
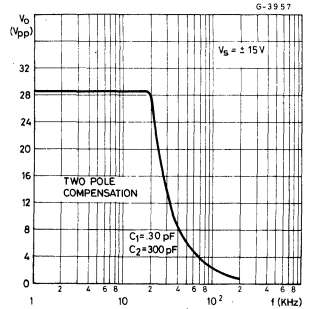

Fig. 24 - Large signal frequency response



FEED FORWARD

Fig. 25

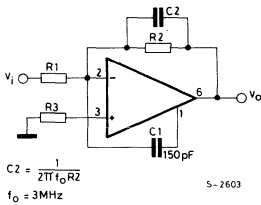

Fig. 26 - Open loop frequency response

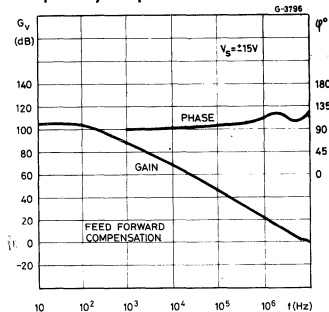

Fig. 27 - Large signal frequency response

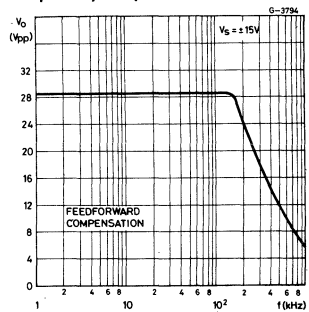

Fig. 28 - Single pole compensation pulse response

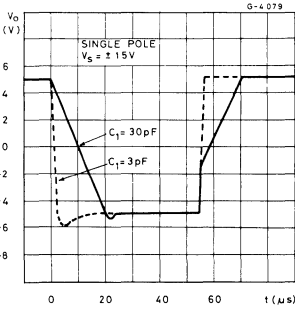

Fig. 29 - Two pole compensation pulse response

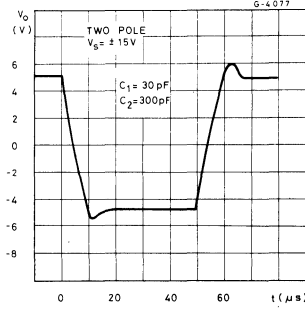
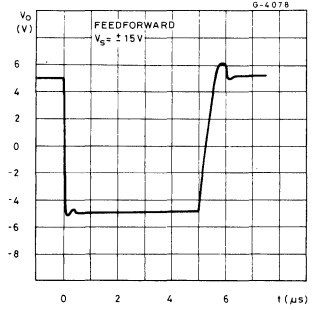

Fig. 30 - Feed forward pulse response



TYPICAL APPLICATIONS

Fig. 31 - Inverting amplifier with balancing circuit

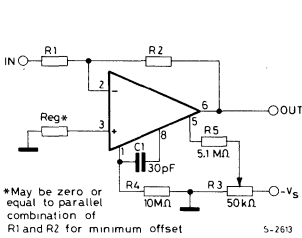

Fig. 32 - Integrator with bias current compensation

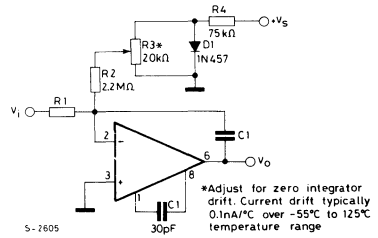

Fig. 33 - Standard compensation and offset balancing circuit

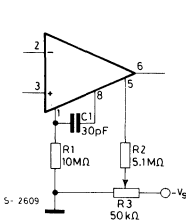
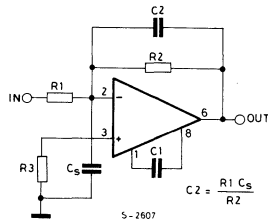

Fig. 34 - Compensation for stray input capacitances or large feedback resistor



TYPICAL APPLICATIONS (continued)

Fig. 35 - Protecting against gross fault conditions

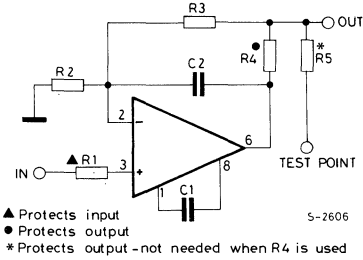

Fig. 36 - Bilateral current source

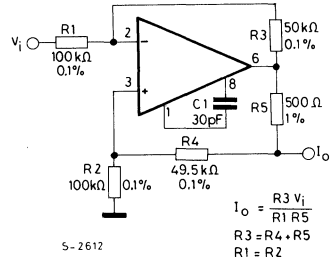

Fig. 37 - Power operational amplifier ($G_v = 40$ dB)

