

3 mm (T1) LED, Non Diffused Super-Bright LED

LS 3341, LY 3341, LG 3341, LP 3341



Besondere Merkmale

- **Gehäusetypp:** eingefärbtes, klares 3 mm (T1) Gehäuse
- **Besonderheit des Bauteils:** Lötspieße mit Aufsetzebene
- **Wellenlänge:** 628 nm (super-rot), 587 nm (gelb), 570 nm (grün), 560 nm (pure green)
- **Abstrahlwinkel:** 40°
- **Technologie:** GaAsP (super-rot, gelb, grün), GaP (pure green)
- **optischer Wirkungsgrad:** 1,5 lm/W (super-rot, gelb), 2,5 lm/W (grün), 0,6 lm/W (pure green)
- **Gruppierungsparameter:** Lichtstärke
- **Lötmethode:** Wellenlöten (TTW)
- **Verpackung:** Schüttgut, gegurtet lieferbar

Anwendungen

- optischer Indikator
- Einkopplung in Lichtleiter
- Hinterleuchtung (LCD, Schalter, Tasten, Displays)
- Innenbeleuchtung im Automobilbereich (z.B. Instrumentenbeleuchtung, u.ä.)

Features

- **package:** colored, clear 3 mm (T1) package
- **feature of the device:** solder leads with stand-off
- **wavelength:** 628 nm (super-red), 587 nm (yellow), 570 nm (green), 560 nm (pure green)
- **viewing angle:** 40°
- **technology:** GaAsP (super-red, yellow, green), GaP (pure green)
- **optical efficiency:** 1.5 lm/W (super-red, yellow), 2.5 lm/W (green), 0.6 lm/W (pure green)
- **grouping parameter:** luminous intensity
- **soldering methods:** TTW soldering
- **packing:** bulk, available taped on reel

Applications

- optical indicators
- coupling into light guides
- backlighting (LCD, switches, keys, displays)
- interior automotive lighting (e.g. dashboard backlighting, etc.)

Typ Type	Emissions- farbe Color of Emission	Gehäuse- farbe Color of Package	Lichtstärke Luminous Intensity $I_F = 10 \text{ mA}$ $I_V \text{ (mcd)}$	Lichtstrom Luminous Flux $I_F = 10 \text{ mA}$ $\Phi_V \text{ (lm)}$	Bestellnummer Ordering Code
LS 3341-LP LS 3341-M LS 3341-N LS 3341-MQ	super-red	red clear	11.2 ... 71.0 18.0 ... 28.0 28.0 ... 45.0 18.0 ... 112.0	35 (typ.) 20 (typ.) 30 (typ.) 55 (typ.)	Q62703Q3911 Q62703Q2146 Q62703Q2147 Q62703Q2148
LY 3341-LP LY 3341-N LY 3341-P LY 3341-MQ	yellow	yellow clear	11.2 ... 71.0 28.0 ... 45.0 45.0 ... 71.0 18.0 ... 112.0	35 (typ.) 30 (typ.) 50 (typ.) 55 (typ.)	Q62703Q2152 Q62703Q2398 Q62703Q3234 Q62703Q2149
LG 3341-KN LG 3341-N LG 3341-P LG 3341-MQ	green	green clear	7.1 ... 45.0 28.0 ... 45.0 45.0 ... 71.0 18.0 ... 112.0	25 (typ.) 30 (typ.) 45 (typ.) 60 (typ.)	Q62703Q2153 Q62703Q3187 Q62703Q4772 Q62703Q2156
LP 3341-JM LP 3341-L LP 3341-M LP 3341-KN	pure green	green clear	4.5 ... 28.0 11.2 ... 18.0 18.0 ... 28.0 7.1 ... 45.0	14 (typ.) 12 (typ.) 20 (typ.) 22 (typ.)	Q62703Q3815 Q62703Q2986 Q62703Q2919 Q62703Q2750

Anm.: Die Standardlieferform von Serientypen beinhaltet eine untere bzw. eine obere Familiengruppe oder mindestens zwei Einzelgruppen.

In einer Verpackungseinheit / Gurt ist immer nur eine Helligkeitsgruppe enthalten.

Die technologiebedingte Helligkeits-Streuung der heutigen LED-Herstellprozesse über einen längeren Fertigungszeitraum (Halbleitermaterial - Chipherstellung - Montageprozess) erlaubt keine Zusage einer einzelnen Helligkeitsgruppe. Daher müssen mindestens zwei Helligkeitsgruppen vorgesehen werden!

Note: The standard shipping format for serial types includes a lower or upper family group or at least two individual groups.

No packing unit / tape ever contains more than one luminous intensity group.

Luminosity variations caused by the technology used in current LED manufacturing processes over a protracted manufacturing period (semiconductor material - chip fabrication - assembly process) mean that it is not possible to assign LEDs to a single luminous intensity group. For this reason at least two luminous intensity groups must be provided!

Bezeichnung Parameter	Symbol Symbol	Werte Values		Einheit Unit
		LS, LY, LG	LP	
Betriebstemperatur Operating temperature range	T_{op}	- 55 ... + 100		°C
Lagertemperatur Storage temperature range	T_{stg}	- 55 ... + 100		°C
Sperrschichttemperatur Junction temperature	T_j	+ 100		°C
Durchlassstrom Forward current ($T_A=25^\circ\text{C}$)	I_F	40	30	mA
Stoßstrom Surge current $t \leq 10 \mu\text{s}, D = 0.005, T_A=25^\circ\text{C}$	I_{FM}	0.5		A
Sperrspannung ¹⁾ Reverse voltage ($T_A=25^\circ\text{C}$)	V_R	12		V
Leistungsaufnahme Power consumption ($T_A=25^\circ\text{C}$)	P_{tot}	130	90	mW
Wärmewiderstand ²⁾ Thermal resistance Sperrschicht/Umgebung ³⁾ Junction/ambient ³⁾	$R_{th JA}$	400		K/W
Sperrschicht/Löt看垫 Junction/solder point Minimale Beinchenlänge Minimum lead length	$R_{th JS}$	180		K/W

1) für kurzzeitigen Betrieb geeignet / suitable for short term application

2) R_{th} erhöht sich um 13 K/W pro mm Beinchenlänge.
Each additional 1 mm of lead length increases R_{th} by 13 K/W.

3) Montage auf PC-Board FR 4 (Padgröße $\geq 16 \text{ mm}^2$)
mounted on PC board FR 4 (pad size $\geq 16 \text{ mm}^2$)

Bezeichnung Parameter	Symbol Symbol	Werte Values				Einheit Unit
		LS	LY	LG	LP	
Wellenlänge des emittierten Lichtes (typ.) Wavelength at peak emission $I_F = 10 \text{ mA}$	λ_{peak}	635	586	572	557	nm
Dominantwellenlänge ¹⁾ (typ.) Dominant wavelength $I_F = 10 \text{ mA}$	λ_{dom}	628	587	570	560	nm
Spektrale Bandbreite bei 50 % $I_{\text{rel max}}$ (typ.) Spectral bandwidth at 50 % $I_{\text{rel max}}$ $I_F = 10 \text{ mA}$	$\Delta\lambda$	45	45	25	22	nm
Abstrahlwinkel bei 50 % I_V (Vollwinkel) (typ.) Viewing angle at 50 % I_V	2ϕ	40	40	40	40	Grad deg.
Durchlassspannung ²⁾ (typ.) Forward voltage (max.) $I_F = 10 \text{ mA}$	V_F V_F	2.0 2.5	2.0 2.5	2.0 2.5	2.0 2.5	V V
Sperrstrom (typ.) Reverse current (max.) $V_R = 12 \text{ V}$	I_R I_R	0.01 10	0.01 10	0.01 10	0.01 10	μA μA
Temperaturkoeffizient von λ_{peak} (typ.) Temperature coefficient of λ_{peak} $I_F = 10 \text{ mA}; -10^\circ\text{C} \leq T \leq 100^\circ\text{C}$	$TC_{\lambda_{\text{peak}}}$	0.11	0.10	0.11	0.11	nm/K
Temperaturkoeffizient von λ_{dom} (typ.) Temperature coefficient of λ_{dom} $I_F = 10 \text{ mA}; -10^\circ\text{C} \leq T \leq 100^\circ\text{C}$	$TC_{\lambda_{\text{dom}}}$	0.07	0.07	0.07	0.05	nm/K
Temperaturkoeffizient von V_F (typ.) Temperature coefficient of V_F $I_F = 10 \text{ mA}; -10^\circ\text{C} \leq T \leq 100^\circ\text{C}$	TC_V	- 1.9	- 1.9	- 1.4	- 2.1	mV/K
Optischer Wirkungsgrad (typ.) Optical efficiency $I_F = 10 \text{ mA}$	η_{opt}	1.5	1.5	2.5	0.6	lm/W

¹⁾ Wellenlängen werden mit einer Stromeinprägungsdauer von 25 ms und einer Genauigkeit von $\pm 1 \text{ nm}$ ermittelt.
Wavelengths are tested at a current pulse duration of 25 ms and a tolerance of $\pm 1 \text{ nm}$.

²⁾ Spannungswerte werden mit einer Stromeinprägungsdauer von 1 ms und einer Genauigkeit von $\pm 0,1 \text{ V}$ ermittelt.
Voltages are tested at a current pulse duration of 1 ms and a tolerance of $\pm 0.1 \text{ V}$.

Helligkeits-Gruppierungsschema
Luminous Intensity Groups

Lichtgruppe Luminous Intensity Group	Lichtstärke Luminous Intensity I_v (mcd)	Lichtstrom Luminous Flux Φ_v (lm)
J	4.5 ... 7.1	5 (typ.)
K	7.1 ... 11.2	8 (typ.)
L	11.2 ... 18.0	12 (typ.)
M	18.0 ... 28.0	20 (typ.)
N	28.0 ... 45.0	30 (typ.)
P	45.0 ... 71.0	45 (typ.)
Q	71.0 ... 112.0	80 (typ.)

Helligkeitswerte werden mit einer Stromeinprägedauer von 25 ms und einer Genauigkeit von $\pm 11\%$ ermittelt.
 Luminous intensity is tested at a current pulse duration of 25 ms and a tolerance of $\pm 11\%$.

Gruppenbezeichnung auf Etikett
Group Name on Label

Beispiel: M
 Example: M

Lichtgruppe
Luminous Intensity Group

M

Relative spektrale Emission $I_{rel} = f(\lambda)$, $T_A = 25\text{ °C}$, $I_F = 10\text{ mA}$

Relative Spectral Emission

$V(\lambda)$ = spektrale Augenempfindlichkeit

Standard eye response curve

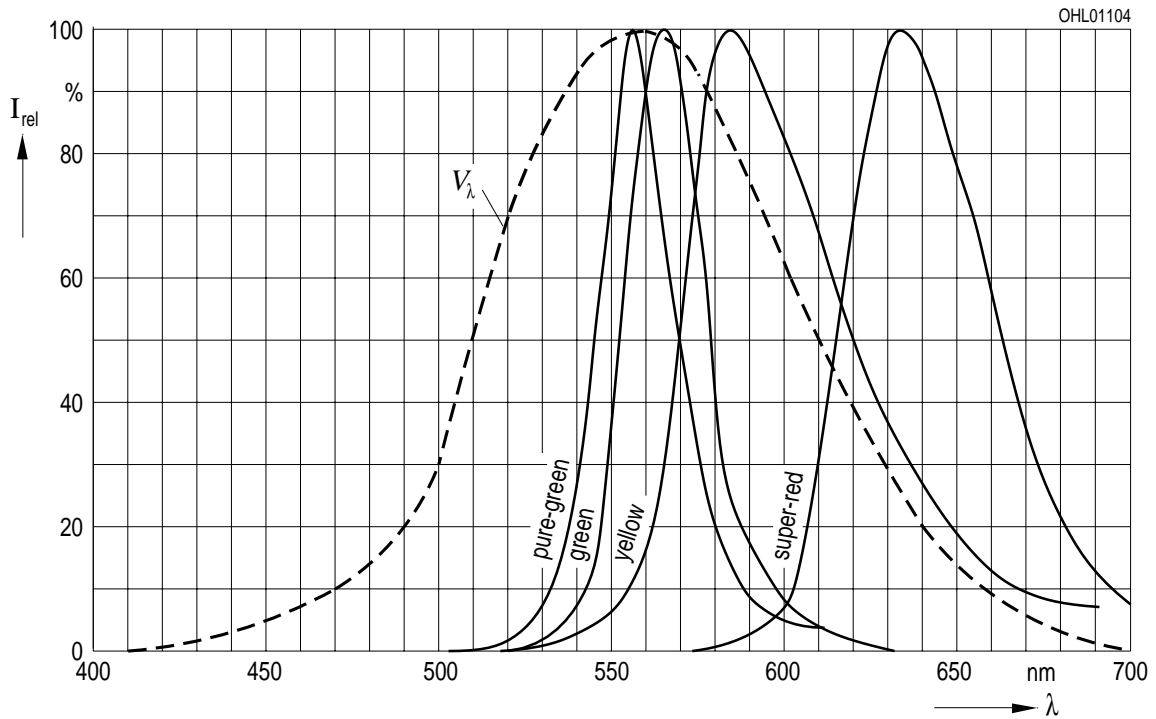

Abstrahlcharakteristik $I_{rel} = f(\varphi)$

Radiation Characteristic

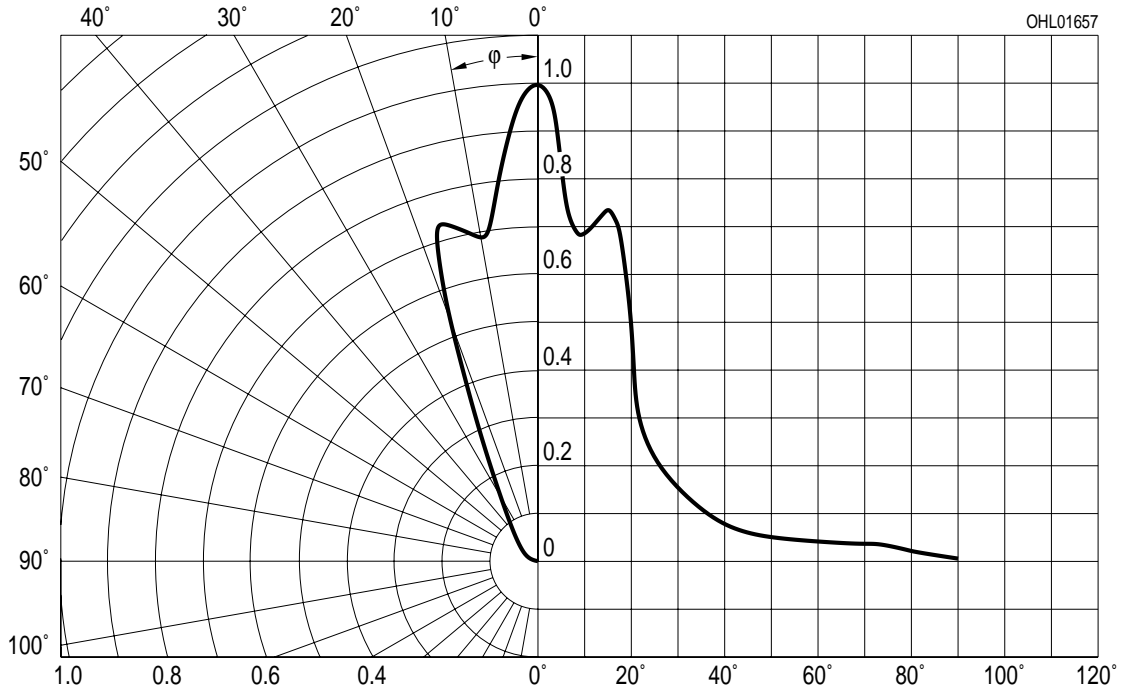

Durchlassstrom $I_F = f(V_F)$
Forward Current

$T_A = 25\text{ °C}$

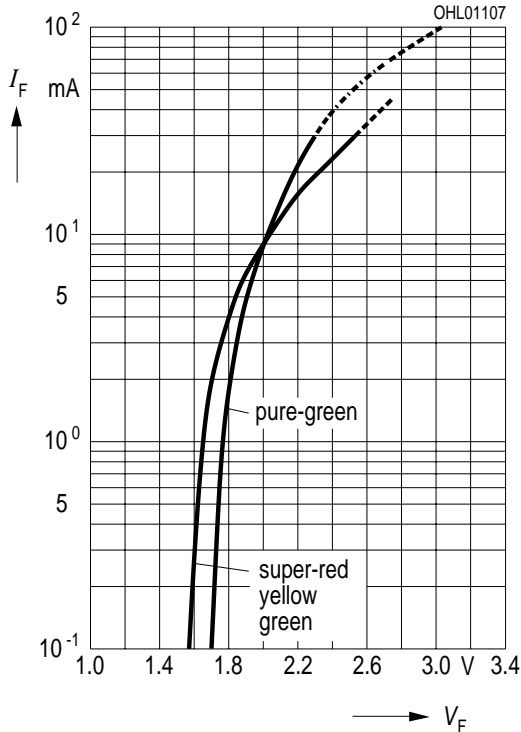

Relative Lichtstärke $I_V/I_{V(10\text{ mA})} = f(I_F)$
Relative Luminous Intensity

$T_A = 25\text{ °C}$

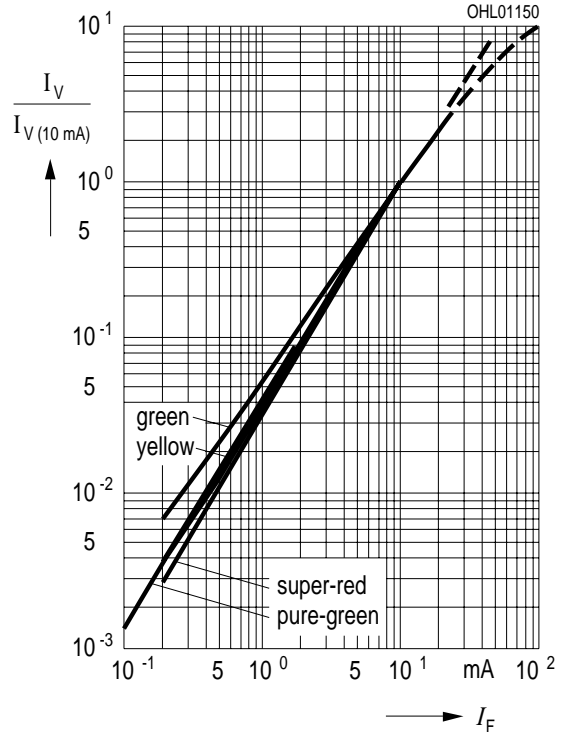

Maximal zulässiger Durchlassstrom $I_F = f(T)$
Max. Permissible Forward Current
LS, LY, LG

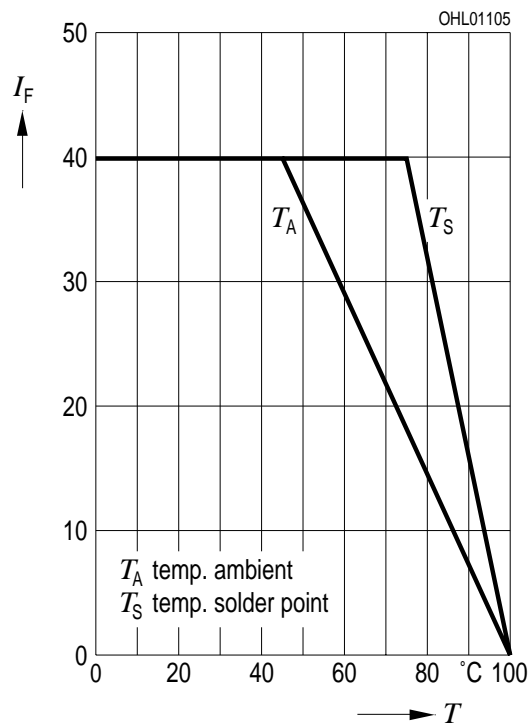

Maximal zulässiger Durchlassstrom $I_F = f(T)$
Max. Permissible Forward Current
LP

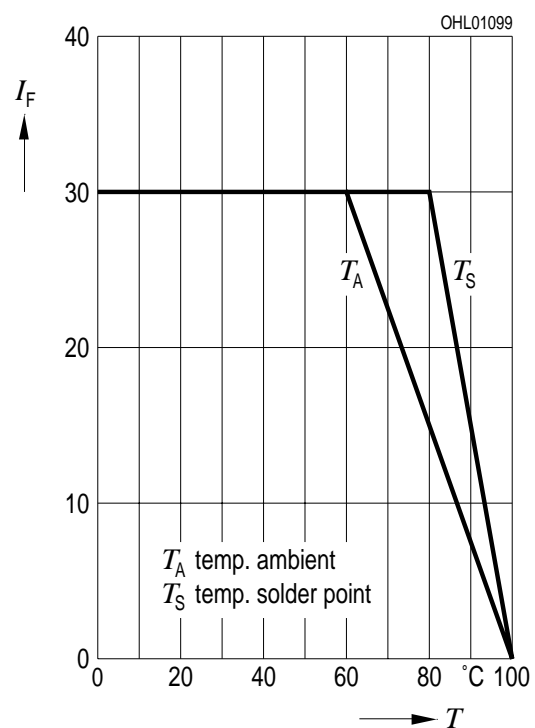

Relative Lichtstärke $I_V/I_{V(25^\circ\text{C})} = f(T_A)$
Relative Luminous Intensity

$I_F = 10 \text{ mA}$

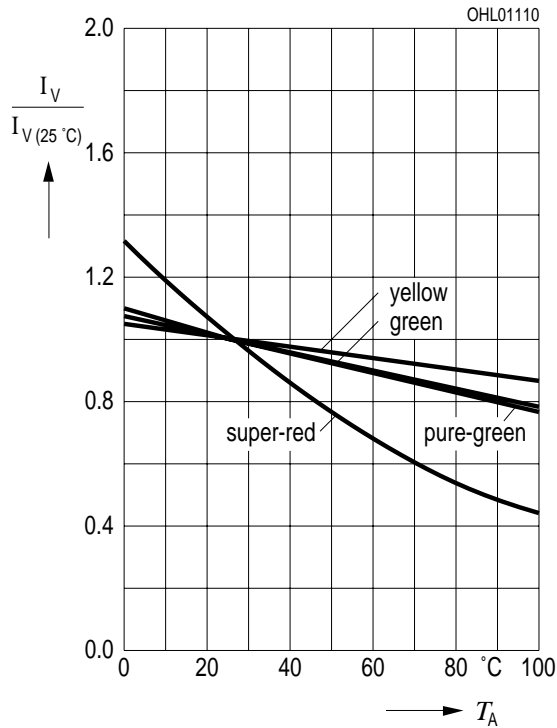

Zulässige Impulsbelastbarkeit $I_F = f(t_p)$
Permissible Pulse Handling Capability
 Duty cycle $D = \text{parameter}$, $T_A = 25^\circ\text{C}$
LS, LY, LG

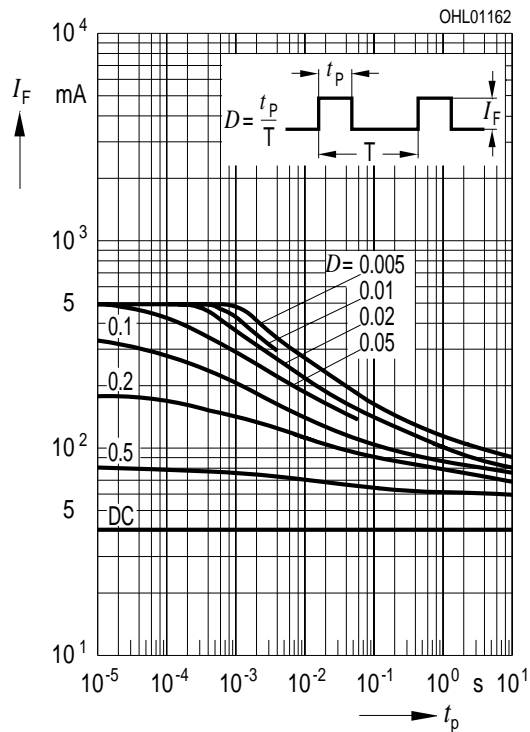

Zulässige Impulsbelastbarkeit $I_F = f(t_p)$
Permissible Pulse Handling Capability
 Duty cycle $D = \text{parameter}$, $T_A = 25^\circ\text{C}$
LP

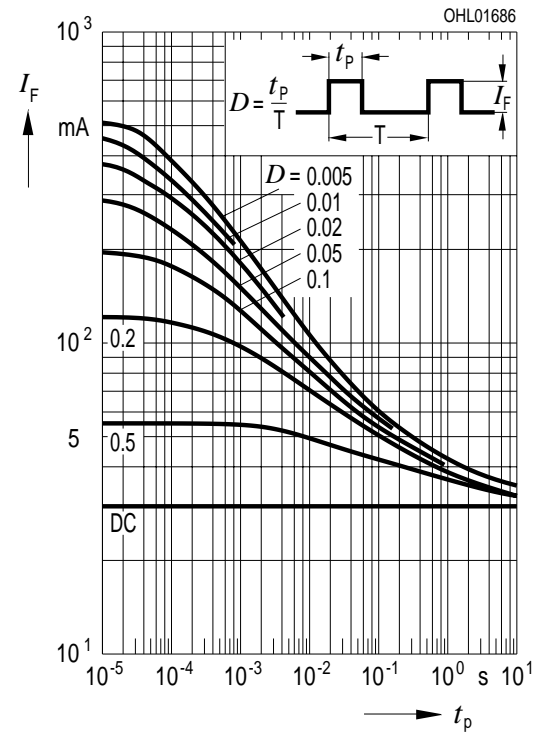

**Maßzeichnung
Package Outlines**

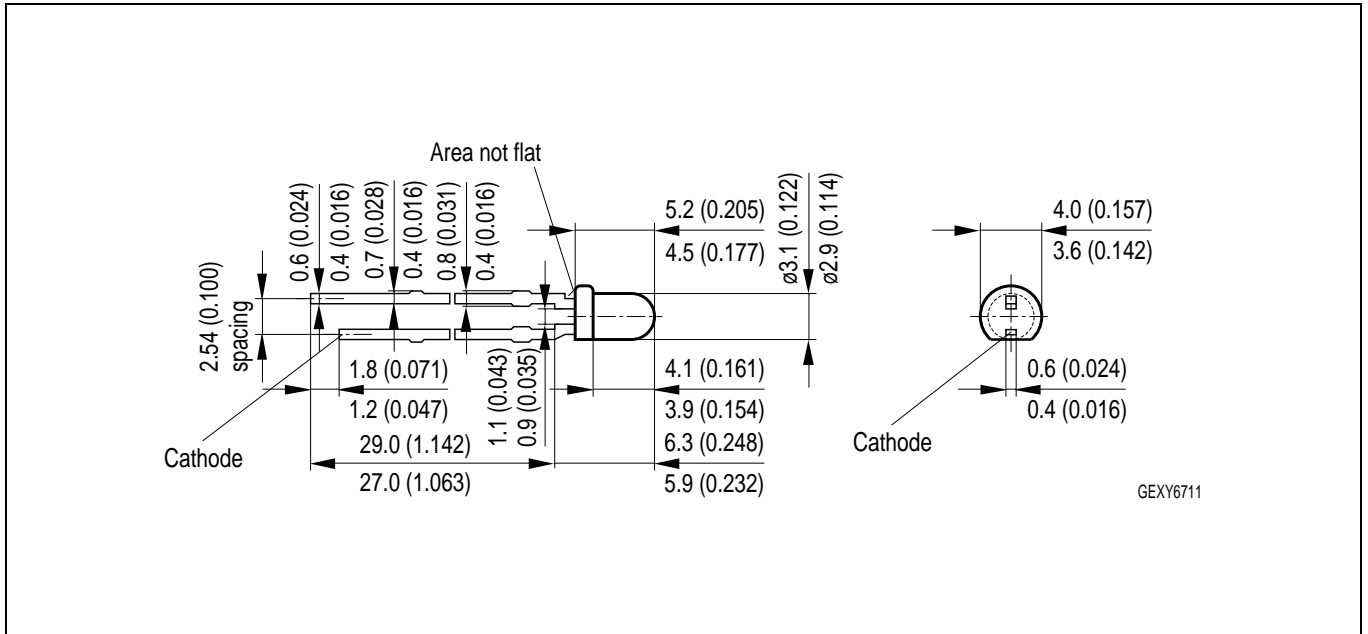

Maße werden wie folgt angegeben: mm (inch) / Dimensions are specified as follows: mm (inch).

Kathodenkennung: kürzerer Lötspieß
Cathode mark: short solder lead
Gewicht / Approx. weight: 0.15 g

Lötbedingungen
Soldering Conditions

Wellenlöten (TTW) (nach CECC 00802)
TTW Soldering (acc. to CECC 00802)

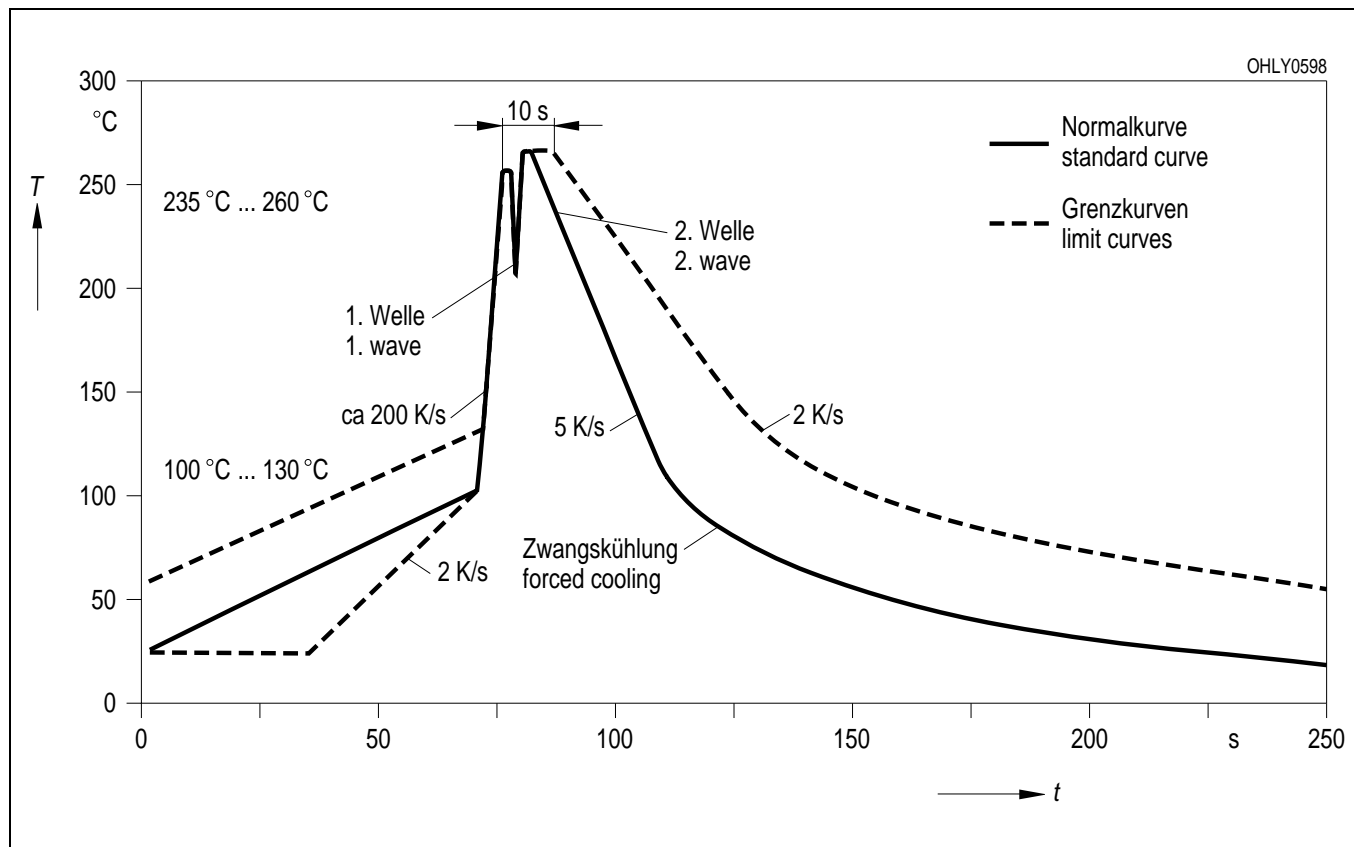

Empfohlenes Lötpaddesign Wellenlöten (TTW)
Recommended Solder Pad TTW Soldering

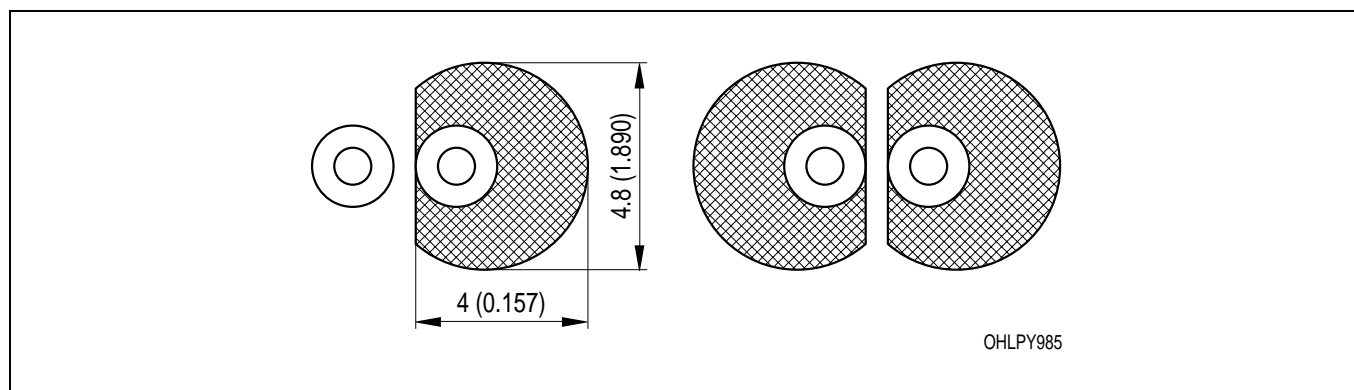

Maße werden wie folgt angegeben: mm (inch) / Dimensions are specified as follows: mm (inch).

Revision History: 2003-09-10		Date of change
Previous Version: 2003-09-03		
Page	Subjects (major changes since last revision)	
3	thermal resistance (footnote)	
10	annotations	2002-07-23
5	luminous intensity groups	2002-07-30
3, 4	value (reverse voltage from 5 V to 12 V)	2002-09-18
2	low yield groups deleted	2003-09-03
1	ESD norm	2003-09-10
3	ambient temperature	2003-09-10

Published by OSRAM Opto Semiconductors GmbH
Wernerwerkstrasse 2, D-93049 Regensburg

© All Rights Reserved.

Attention please!

The information describes the type of component and shall not be considered as assured characteristics. All typical data and graphs are basing on representative samples, but don't represent the production range. If requested, e.g. because of technical improvements, these typ. data will be changed without any further notice. Terms of delivery and rights to change design reserved. Due to technical requirements components may contain dangerous substances. For information on the types in question please contact our Sales Organization. If printed or downloaded, please find the latest version in the Internet.

Packing

Please use the recycling operators known to you. We can also help you – get in touch with your nearest sales office. By agreement we will take packing material back, if it is sorted. You must bear the costs of transport. For packing material that is returned to us unsorted or which we are not obliged to accept, we shall have to invoice you for any costs incurred.

Components used in life-support devices or systems must be expressly authorized for such purpose! Critical components ¹ may only be used in life-support devices or systems ² with the express written approval of OSRAM OS.

¹ A critical component is a component used in a life-support device or system whose failure can reasonably be expected to cause the failure of that life-support device or system, or to affect its safety or the effectiveness of that device or system.

² Life support devices or systems are intended (a) to be implanted in the human body, or (b) to support and/or maintain and sustain human life. If they fail, it is reasonable to assume that the health of the user may be endangered.