



SAMSUNG DISPLAY



Product Specification

Preliminary Specification

Approval Specification

The information described in this specification is preliminary and can be changed without prior notice.

CUSTOMER	CT Frank
DATE OF ISSUE	2013/4/4

MODEL NO.	LSC400HM06
EXTENSION CODE	T

LCD Sales & Marketing Team
Samsung Display Co., Ltd

Table of Contents

REVISION HISTORY	3
1. GENERAL DESCRIPTION	4
2. ABSOLUTE MAXIMUM RATINGS	5
3. OPTICAL CHARACTERISTICS	6
4. ELECTRICAL CHARACTERISTICS	9
4.1 TFT LCD MODULE	9
5. INPUT TERMINAL PIN ASSIGNMENT	10
5.1 INPUT SIGNAL & POWER.....	10
5.2 LVDS INTERFACE.....	13
5.3 INPUT COLOR DATA MAPPING.....	14
6. INTERFACE TIMING	15
6.1 TIMING PARAMETERS OF TIMING (ONLY DE MODE).....	15
6.2 TIMING DIAGRAMS OF INTERFACE SIGNAL	15
6.3 CHARACTERISTICS OF INPUT DATA OF LVDS	16
6.4 POWER ON/OFF SEQUENCE	17
7. OUTLINE DIMENSION	18
8. PACKING	19
8.1 CARTON.....	19
8.2 MARKING	20
9. GENERAL PRECAUTIONS	22
9.1 HANDLING	22
9.2 STORAGE	24
9.3 OPERATION	24
9.4 OPERATION CONDITION GUIDE.....	25
9.5 PROCESS EXECUTING GUIDE.....	25
9.6 OTHERS.....	26
10. SPECIAL PRECAUTIONS	27
APPENDIX – RECOMMENDATION FOR THE BLU DESIGN	28

REVISION HISTORY

Date.	Rev.No.	Page	Revision Description
2013/4/4	000		Initial Release

For eyes of CT Frank only

1. GENERAL DESCRIPTION

DESCRIPTION

This model uses a liquid crystal display (LCD) of amorphous silicon TFT as switching components. This model is composed of a TFT LCD panel, a driver circuit, and an ass'y KIT of source PBA. This 40.0" model has a resolution of a 1920 x 1080 and can display up to 1.07 Billion colors with the wide viewing angle of 89° or a higher degree in all directions. This panel is designed to support applications by providing an excellent performance function of the flat panel display such as home-alone multimedia TFT-LCD TV and a high definition TV.

FEATURES

- RoHS compliance (Pb-free)
- High contrast ratio & aperture ratio with the wide color gamut
- S-PVA (Super Patterned vertical align) mode
- Wide viewing angle (±89°)
- High speed response
- FHD resolution (1920 x 1080, 16:9)
- DE (Data enable) mode
- The interface (2Pixel/clock) of 2ch LVDS (Low voltage differential signaling)

GENERAL INFORMATION

Item	Specification	Unit	Note
Active Display Area	885.60 (H) x 498.15 (V)	mm	
Switching Components	a-Si TFT Active matrix		
Glass size	TFT :906.40(H) x 518.00(V) CF : 906.40(H) x 515.26(V)	mm	±0.5mm
Panel Size	906.40(H) x 518.00(V)	mm	±0.5mm
	1.80(D)	mm	±0.1mm
Weight	2090 (Max)	g	
Display Colors	1.07B (Dithered 10bit)		
Number of Pixels	1920 × 1080		16:9
Pixel Arrangement	RGB Horizontal Stripe	mm	
Display Mode	Normally Black		
Surface Treatment	Anti Glare		

2. ABSOLUTE MAXIMUM RATINGS

If the figures on measuring instruments exceed maximum ratings, it can cause the malfunction or the unrecoverable damage on the device.

Item	Symbol	Min.	Max.	Unit	Note
Power supply voltage	V_{DD}	10.8	13.2	V	(1)
Temperature for storage (Temperature of glass surface)	T_{STG}	-20	60	°C	(2), (4)
Humidity for storage	H_{STG}	5	90	%RH	(2), (4)
Operating temperature	T_{OPR}	0	50	°C	(2), (5)
Operating humidity	H_{STG}	20	90	%RH	(2), (5)
Endurance on static electricity			150	V	(3)

Note (1) The power supply voltage at $T_a = 25 \pm 2 \text{ }^\circ\text{C}$

(2) Temperature and the range of relative humidity are shown in the figure below.

a. 90 % RH Max. ($T_a \leq 39 \text{ }^\circ\text{C}$)

b. The relative humidity is 90% or less. ($T_a > 39 \text{ }^\circ\text{C}$)

c. No condensation

(3) Keep the static electricity under 150V in process the polarizer is attached on glass.

(4) Storage condition with glass.

(5) Operating condition with assembly

(6) Condition without packing.(Unpacking condition)

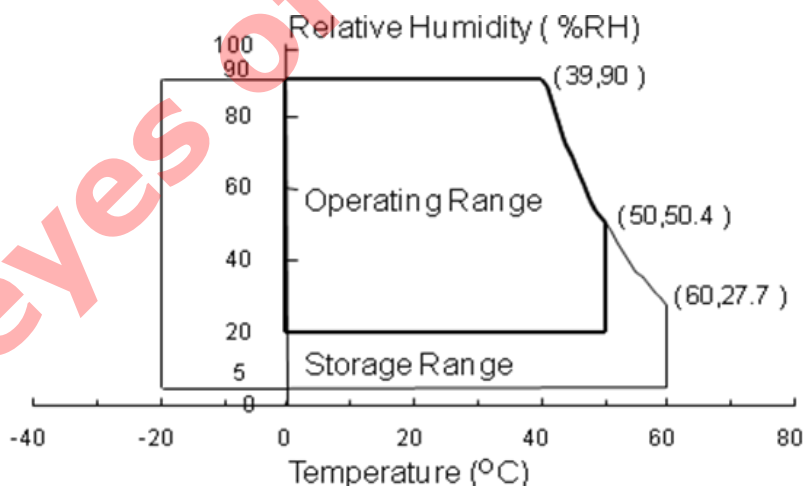

Fig. Range for temperature and relative humidity (unpacking condition)

3. OPTICAL CHARACTERISTICS

The optical characteristics should be measured in the dark room or the space surrounded by the similar setting. Measuring equipment : TOPCON RD-80S, TOPCON SR-3 ,ELDIM EZ-Contrast

Ta = 25 ± 2°C, VDD=12.0V, fv=60Hz, fDCLK=148.5MHz, Light source: D65 Standard Light

Item	Symbol	Condition	Min.	Typ.	Max.	Unit	Note
Contrast Ratio	CR		3000	5000	-	-	(1) SR-3
Response time	G-to-G	Tg	-	8	16	msec	(2) RD-80S
Luminance of white (At the center of screen))	Y _L		280	340	-	cd/m ²	(3) SR-3
Color Chromaticity (CIE)	Red	RX	Normal q _{L,R} =0 q _{U,D} =0 Viewing Angle	TYP -0.03	TYP +0.03		(4),(5) SR-3
		RY					
	Green	GX					
		GY					
	Blue	BX					
		BY					
	White	WX					
		WY					
Viewing Angle	Hor.	q _l	75	89	-	Degrees	(5) SR-3 EZ-Contrast
		q _r	75	89	-		
	Ver.	q _u	75	89	-		
		q _d	75	89	-		
Color Gamut			67	69	-	%	
Color			5000	7000	-	K	

Notice

(a) Setup for test equipment

The measurement should be executed in a stable, windless, and dark room for 40min and 60min after operating the panel at the given temperature for stabilization of the standard light. (SDC uses the standard luminance of the D65media).

This measurement should be measured at the center of screen.

The environment condition: Ta = 25 ± 2 °C

(b) D65media has the general light source.

The temperature of color is 6487K. The coordinate of color is Wx 0.313, Wy 0.329

The luminance of this product is 7217cd/m².

Photo detector	Field
SR-3	2°
RD-80S	1°

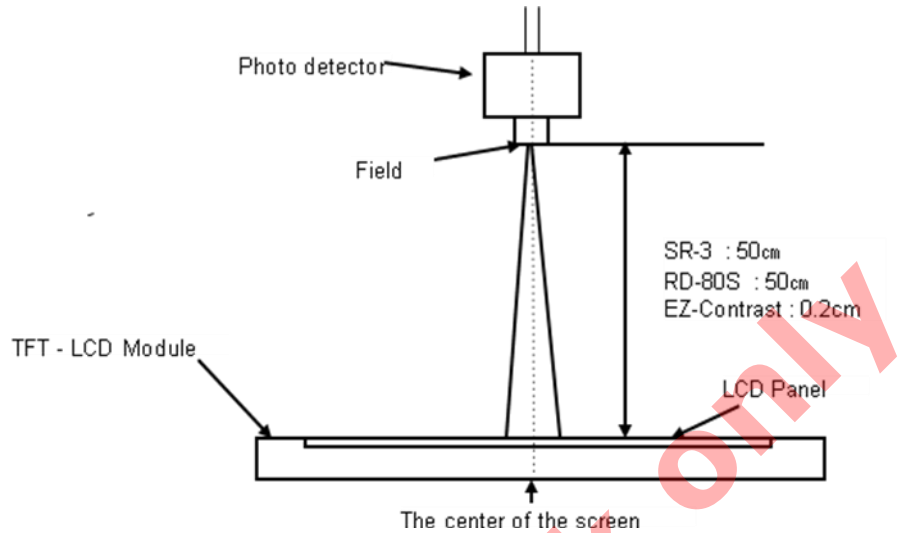

(c) The CIE positions D65 as the standard daylight illuminant: [D65] is intended to represent average daylight and has a correlated color temperature of approximately 6500 K. CIE standard illuminant D65 should be used in all colorimetric calculations requiring representative daylight, unless there are specific reasons for using a different illuminant.

- Definition of the test point

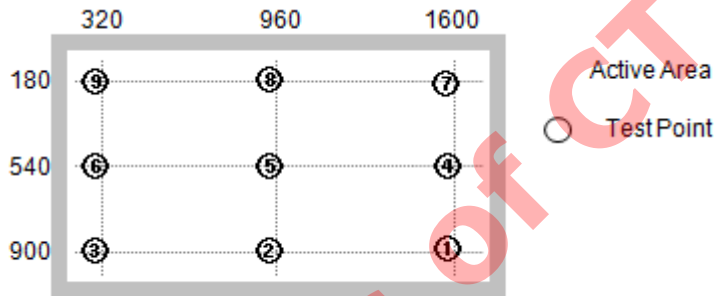

Note (1) Definition of contrast ratio (C/R)

: The ratio of gray max (Gmax) & gray min (Gmin) at the center point ⑤ of the panel
The measurement goes in ELABO-LS Standard light source

$$C/R = \frac{G_{max}}{G_{min}}$$

Gmax : The luminance with all white pixels

Gmin : The luminance with all black pixels

Note (2) Definition of response time

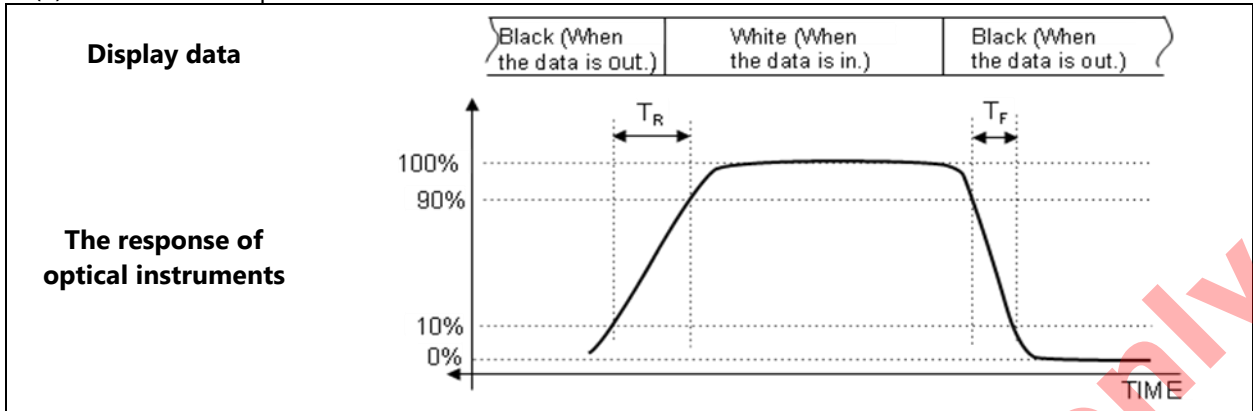

※ G-to-G : Average response time between the whole gray scale to the whole gray scale.

The response time is the value that was measured after it was operated in Samsung's standard BLU for one hour.(at room temperature)

Note (3) Definition of transmissivity.

The measurement shall be executed with the standard light source of D65.

Note (4) The definition of chromaticity (CIE 1931)

The color coordinate of red, green, blue and white at the center point ⑤

The measurement shall be executed with the standard light source of D65

Note (5) Definition of viewing angle

: The range of viewing angle ($C/R \geq 10$)

The measurement shall be executed with the standard light source of D65

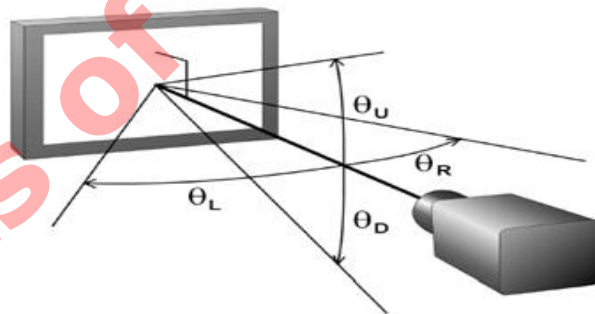

4. ELECTRICAL CHARACTERISTICS

4.1 TFT LCD MODULE

* Ta = 25 ± 2 °C

Item	Symbol	Min.	Typ.	Max.	Unit	Note
Voltage of power supply	VDD	10.8	12.0	13.2	V	(1)
Current of power supply	(a) Black	-	500	600	mA	(2),(3)
	(b) White	-	470	550	mA	
	(c) Sub H-Stripe	-	800	1000	mA	
Vsync frequency	fV	48	60	62.5	Hz	
Hsync frequency	fH	60	67.5	70	kHz	
Main frequency	Fdclk	130	148.5	152.5	MHz	
Rush current	IRUSH	-	-	3	A	(4)

Note (1) The ripple voltage should be controlled fewer than 10% of V_{DD} (Typ.) voltage.

(2) fV=60Hz, fDCLK = 148.5MHz, V_{DD} = 12.0V, DC Current.

(3) Power dissipation check pattern (LCD Module only)

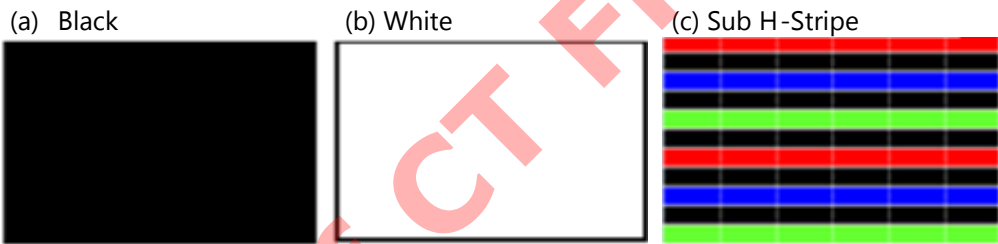

(4) Conditions for measurement

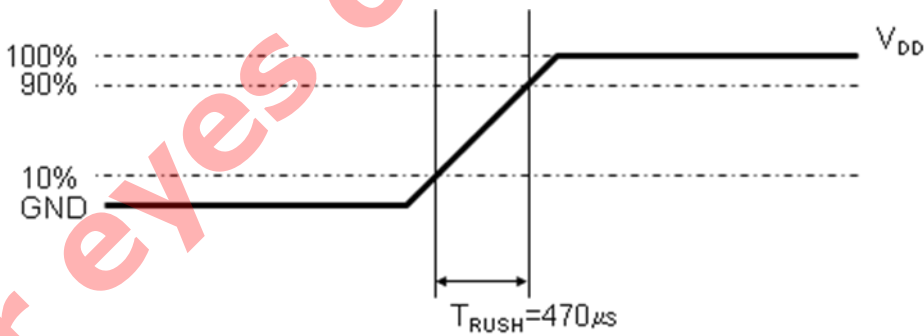

The rush current, I_{RUSH} can be measured when T_{RUSH} is 470µs.

5. INPUT TERMINAL PIN ASSIGNMENT

5.1 INPUT SIGNAL & POWER

Connector : FI-RXE51S-HF (JAE)

Pin	Symbol	Description	Pin	Symbol	Description
1	NC	NOTE1	26	NC	NOTE1
2	NC	NOTE1	27	NC	NOTE1
3	NC	NOTE1	28	Rx2[A]N	Even LVDS Signal -
4	NC	NOTE1	29	Rx2[A]P	Even LVDS Signal +
5	NC	NOTE1	30	Rx2[B]N	Even LVDS Signal -
6	NC	NOTE1	31	Rx2[B]P	Even LVDS Signal +
7	LVDS selection	NOTE2	32	Rx2[C]N	Even LVDS Signal -
8	NC	NOTE1	33	Rx2[C]P	Even LVDS Signal +
9	NC	NOTE1	34	GND	Ground
10	NC	NOTE1	35	Rx2CLK-	LVDS Clock -
11	GND	Ground	36	Rx2CLK+	LVDS Clock +
12	Rx1[A]N	Odd LVDS Signal -	37	GND	Ground
13	Rx1[A]P	Odd LVDS Signal +	38	Rx2[D]N	Even LVDS Signal -
14	Rx1[B]N	Odd LVDS Signal -	39	Rx2[D]P	Even LVDS Signal +
15	Rx1[B]P	Odd LVDS Signal +	40	Rx2[E]N (Note 2)	Even LVDS Signal -
16	Rx1[C]N	Odd LVDS Signal -	41	Rx2[E]P (Note 2)	Even LVDS Signal +
17	Rx1[C]P	Odd LVDS Signal +	42	NC	NOTE1
18	GND	Ground	43	NC	NOTE1
19	Rx1CLK-	LVDS Clock -	44	GND	Ground
20	Rx1CLK+	LVDS Clock +	45	GND	Ground
21	GND	Ground	46	GND	Ground
22	Rx1[D]N	Odd LVDS Signal -	47	NC	NOTE1
23	Rx1[D]P	Odd LVDS Signal +	48	12V	DC power supply
24	Rx1[E]N (Note 2)	Odd LVDS Signal -	49	12V	DC power supply
25	Rx1[E]P (Note 2)	Odd LVDS Signal +	50	12V	DC power supply
			51	12V	DC power supply

Note (1) No connection: These PINS are used only for the product of SAMSUNG.
(DO NOT CONNECT the input device to these pins.)

Note (2) LVDS selection : If this pin : Low(GND V) / NC → JEIDA LVDS format
Otherwise : High(3.3V) → Normal LVDS

NOTE(2) Parameter		Symbol	Value			Unit	Note
			Min	Typ	Max		
Interface	Input High Voltage	High	2.8	-	3.6	V	
	Input Low Voltage	Low	0	-	0.8	V	

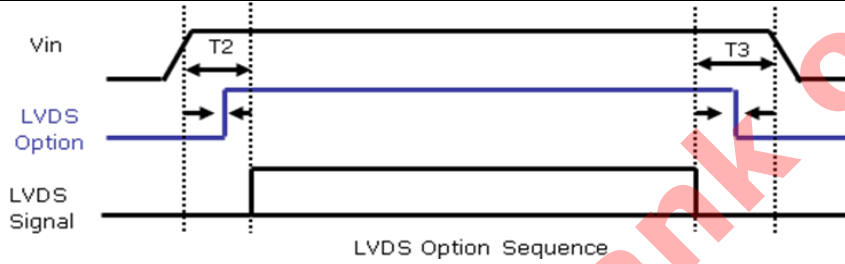

Note (3) Input mode 8bit setting @ 8bit input → E_Channel : Floating
Input mode 10bit setting @ 8bit input → E_Channel : Keep Level'0'
Pin No.24 / Pin No.40 : Pull up(3.3V)
Pin No.25 / Pin No.41 : Pull down(GND)

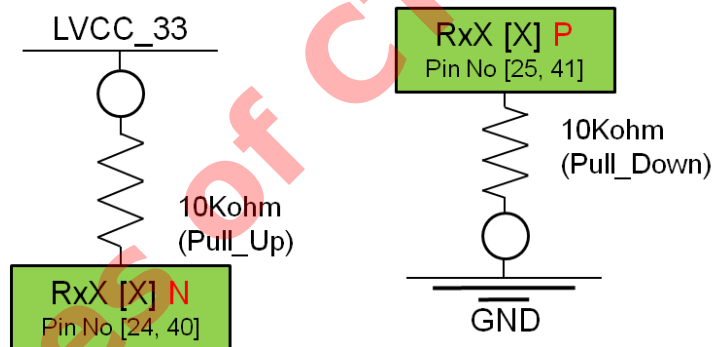

Note (4) Pin number which starts from the left side.

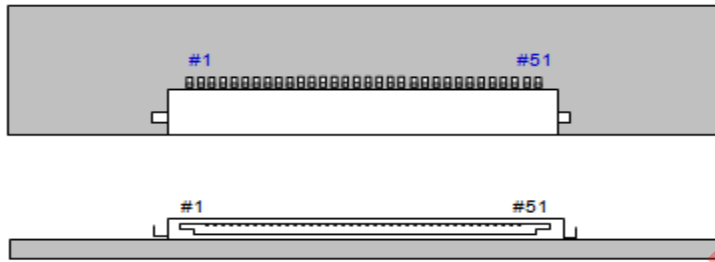
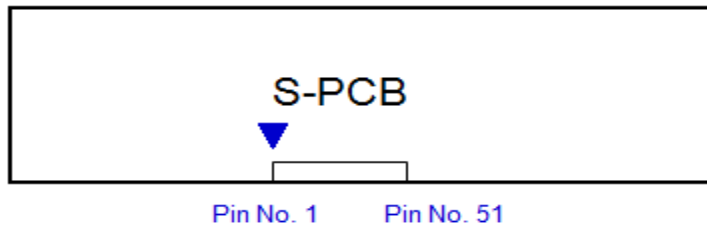

Fig. Connector diagram

Fig . The diagram of connector

- a. Power GND pins should be connected to the LCD's metal chassis.
- b. All power input pins should be connected together.
- c. All NC pins should be separated from other signal or power.

5.2 LVDS INTERFACE

- LVDS receiver : T-con(merged)

- Data format

	LVDS pin	VESA (Normal)	JEIDA
TxOUT/RxINA	TxIN/RxOUT0	R0	R4
	TxIN/RxOUT1	R1	R5
	TxIN/RxOUT2	R2	R6
	TxIN/RxOUT3	R3	R7
	TxIN/RxOUT4	R4	R8
	TxIN/RxOUT6	R5	R9
	TxIN/RxOUT7	G0	G4
TxOUT/RxINB	TxIN/RxOUT8	G1	G5
	TxIN/RxOUT9	G2	G6
	TxIN/RxOUT12	G3	G7
	TxIN/RxOUT13	G4	G8
	TxIN/RxOUT14	G5	G9
	TxIN/RxOUT15	B0	B4
	TxIN/RxOUT18	B1	B5
TxOUT/RxINC	TxIN/RxOUT19	B2	B6
	TxIN/RxOUT20	B3	B7
	TxIN/RxOUT21	B4	B8
	TxIN/RxOUT22	B5	B9
	TxIN/RxOUT24	HSYNC	HSYNC
	TxIN/RxOUT25	VSYNC	VSYNC
	TxIN/RxOUT26	DEN	DEN
TxOUT/RxIND	TxIN/RxOUT27	R6	R2
	TxIN/RxOUT5	R7	R3
	TxIN/RxOUT10	G6	G2
	TxIN/RxOUT11	G7	G3
	TxIN/RxOUT16	B6	B2
	TxIN/RxOUT17	B7	B3
	TxIN/RxOUT23	RESERVED	RESERVED
TxOUT/RxINE	TxIN/RxOUT28	R8	R0
	TxIN/RxOUT29	R9	R1
	TxIN/RxOUT30	G8	G0
	TxIN/RxOUT31	G9	G1
	TxIN/RxOUT32	B8	B0
	TxIN/RxOUT33	B9	B1
	TxIN/RxOUT34	RESERVED	RESERVED

5.3 INPUT COLOR DATA MAPPING

COLOR	DISPLAY (10bit)	DATA SIGNAL																													GRAY SCALE LEVEL						
		RED									GREEN									BLUE																	
		R0	R1	R2	R3	R4	R5	R6	R7	R8	R9	G0	G1	G2	G3	G4	G5	G6	G7	G8	G9	B0	B1	B2	B3	B4	B5	B6	B7	B8		B9					
BASIC COLOR	BLACK	0	0	0	0	0	0	0	0	0	0	0	0	0	0	0	0	0	0	0	0	0	0	0	0	0	0	0	0	0	0	0	0	0	0	-	
	BLUE	0	0	0	0	0	0	0	0	0	0	0	0	0	0	0	0	0	0	0	0	0	1	1	1	1	1	1	1	1	1	1	1	1	1	-	
	GREEN	0	0	0	0	0	0	0	0	0	0	1	1	1	1	1	1	1	1	1	1	0	0	0	0	0	0	0	0	0	0	0	0	0	0	-	
	CYAN	0	0	0	0	0	0	0	0	0	0	1	1	1	1	1	1	1	1	1	1	1	1	1	1	1	1	1	1	1	1	1	1	1	1	-	
	RED	1	1	1	1	1	1	1	1	1	1	0	0	0	0	0	0	0	0	0	0	0	0	0	0	0	0	0	0	0	0	0	0	0	0	0	-
	MAGENTA	1	1	1	1	1	1	1	1	1	1	0	0	0	0	0	0	0	0	0	0	0	1	1	1	1	1	1	1	1	1	1	1	1	1	-	
	YELLOW	1	1	1	1	1	1	1	1	1	1	1	1	1	1	1	1	1	1	1	1	0	0	0	0	0	0	0	0	0	0	0	0	0	0	0	-
	WHITE	1	1	1	1	1	1	1	1	1	1	1	1	1	1	1	1	1	1	1	1	1	1	1	1	1	1	1	1	1	1	1	1	1	1	1	-
GRAY SCALE OF RED	BLACK	0	0	0	0	0	0	0	0	0	0	0	0	0	0	0	0	0	0	0	0	0	0	0	0	0	0	0	0	0	0	0	0	0	R0		
	DARK ↑	1	0	0	0	0	0	0	0	0	0	0	0	0	0	0	0	0	0	0	0	0	0	0	0	0	0	0	0	0	0	0	0	0	R1		
		0	1	0	0	0	0	0	0	0	0	0	0	0	0	0	0	0	0	0	0	0	0	0	0	0	0	0	0	0	0	0	0	0	R2		
		:	:	:	:	:	:	:	:	:	:	:	:	:	:	:	:	:	:	:	:	:	:	:	:	:	:	:	:	:	:	:	:	:	:	R3~R1020	
		:	:	:	:	:	:	:	:	:	:	:	:	:	:	:	:	:	:	:	:	:	:	:	:	:	:	:	:	:	:	:	:	:	:	:	R1021
	↓ LIGHT	1	0	1	1	1	1	1	1	1	1	0	0	0	0	0	0	0	0	0	0	0	0	0	0	0	0	0	0	0	0	0	0	0	0	R1022	
		0	1	1	1	1	1	1	1	1	1	0	0	0	0	0	0	0	0	0	0	0	0	0	0	0	0	0	0	0	0	0	0	0	0	0	R1023
	RED	1	1	1	1	1	1	1	1	1	1	0	0	0	0	0	0	0	0	0	0	0	0	0	0	0	0	0	0	0	0	0	0	0	0	0	R1023
GRAY SCALE OF GREEN	BLACK	0	0	0	0	0	0	0	0	0	0	0	0	0	0	0	0	0	0	0	0	0	0	0	0	0	0	0	0	0	0	0	0	0	0	G0	
	DARK ↑	0	0	0	0	0	0	0	0	0	0	1	0	0	0	0	0	0	0	0	0	0	0	0	0	0	0	0	0	0	0	0	0	0	0	0	G1
		0	0	0	0	0	0	0	0	0	0	1	0	0	0	0	0	0	0	0	0	0	0	0	0	0	0	0	0	0	0	0	0	0	0	0	G2
		:	:	:	:	:	:	:	:	:	:	:	:	:	:	:	:	:	:	:	:	:	:	:	:	:	:	:	:	:	:	:	:	:	:	:	G3~G1020
		:	:	:	:	:	:	:	:	:	:	:	:	:	:	:	:	:	:	:	:	:	:	:	:	:	:	:	:	:	:	:	:	:	:	:	G1021
	↓ LIGHT	0	0	0	0	0	0	0	0	0	0	1	0	1	1	1	1	1	1	1	1	0	0	0	0	0	0	0	0	0	0	0	0	0	0	0	G1022
		0	0	0	0	0	0	0	0	0	0	1	1	1	1	1	1	1	1	1	1	0	0	0	0	0	0	0	0	0	0	0	0	0	0	0	G1023
	GREEN	0	0	0	0	0	0	0	0	0	0	1	1	1	1	1	1	1	1	1	1	0	0	0	0	0	0	0	0	0	0	0	0	0	0	0	G1023
GRAY SCALE OF BLUE	BLACK	0	0	0	0	0	0	0	0	0	0	0	0	0	0	0	0	0	0	0	0	0	0	0	0	0	0	0	0	0	0	0	0	0	0	B0	
	DARK ↑	0	0	0	0	0	0	0	0	0	0	0	0	0	0	0	0	0	0	0	0	0	1	0	0	0	0	0	0	0	0	0	0	0	0	B1	
		0	0	0	0	0	0	0	0	0	0	0	0	0	0	0	0	0	0	0	0	0	0	1	0	0	0	0	0	0	0	0	0	0	0	B2	
		:	:	:	:	:	:	:	:	:	:	:	:	:	:	:	:	:	:	:	:	:	:	:	:	:	:	:	:	:	:	:	:	:	:	:	B3~B1020
		:	:	:	:	:	:	:	:	:	:	:	:	:	:	:	:	:	:	:	:	:	:	:	:	:	:	:	:	:	:	:	:	:	:	:	B1021
	↓ LIGHT	0	0	0	0	0	0	0	0	0	0	0	0	0	0	0	0	0	0	0	0	0	1	0	1	1	1	1	1	1	1	1	1	1	1	B1022	
		0	0	0	0	0	0	0	0	0	0	0	0	0	0	0	0	0	0	0	0	0	1	1	1	1	1	1	1	1	1	1	1	1	1	1	B1023
	BLUE	0	0	0	0	0	0	0	0	0	0	0	0	0	0	0	0	0	0	0	0	0	1	1	1	1	1	1	1	1	1	1	1	1	1	B1023	

Note (1) Definition of gray : Rn: Red gray, Gn: Green gray, Bn: Blue gray (n=gray level)
 Note (2) Input signal: 0 =Low level voltage, 1=High level voltage

6. INTERFACE TIMING

6.1 TIMING PARAMETERS OF TIMING (Only DE Mode)

Signal	Item	Symbol	Min.	Typ.	Max.	Unit	Note
Clock	Frequency	$1/T_C$	130	148.5	160	MHz	-
Hsync		F_H	60	67.5	70	KHz	-
Vsync		F_V	48	60	62.5	Hz	-
Term for the Vertical Display	Active display period	T_{VD}		1080		Lines	-
	Total vertical	T_V	1110	1125	1400	Lines	-
Term for the Horizontal Display	Active display Period	T_{HD}		1920		Clocks	-
	Total Horizontal	T_H	2092	2200	2348	clocks	-

Note) These products don't have to receive the signal of Hsync & Vsync from the input device.

(1)Key points when testing: TTL controls the signal and the CLK at the input terminal of LVDS Tx of the system.

(2) Internal VDD = 3.3V

(3) Spread spectrum

* The limit of spread spectrum's range of SET in which the LCD module is assembled should be within $\pm 1.5\%$.

6.2 TIMING DIAGRAMS OF INTERFACE SIGNAL

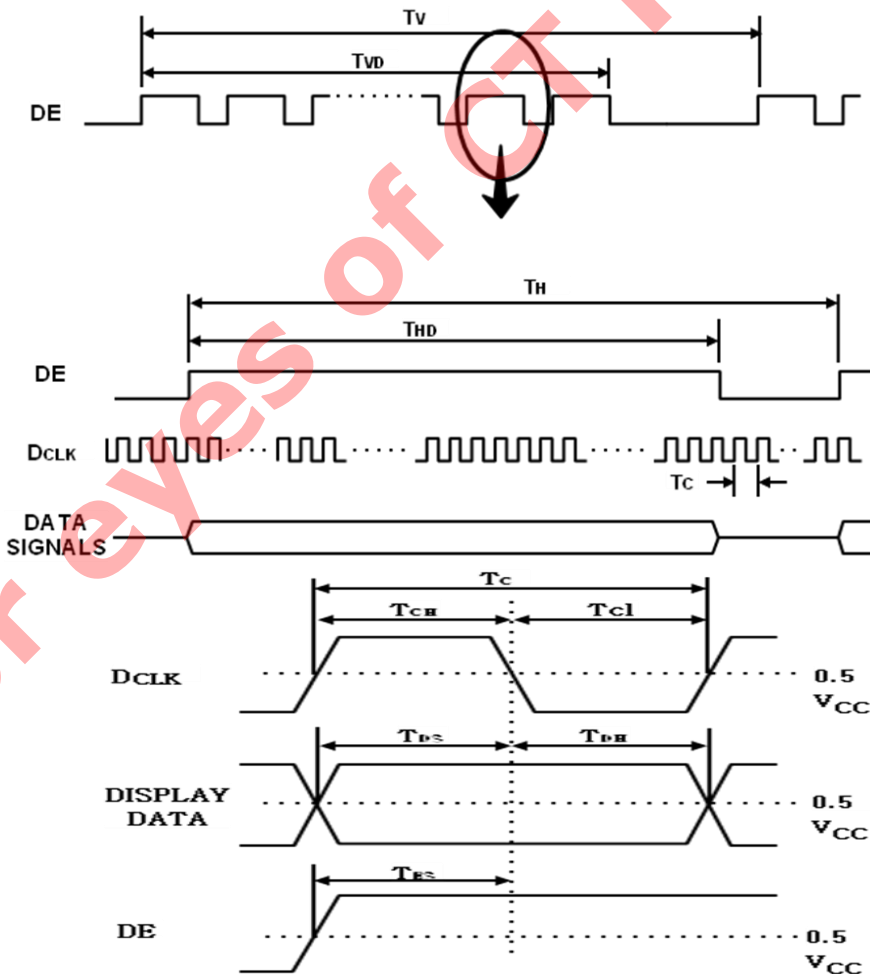

6.3 CHARACTERISTICS OF INPUT DATA OF LVDS

ITEM	SYMBOL	Min.	Typ.	Max.	UNIT	NOTE
Differential input high threshold voltage	V _{TH}	-	-	100	mV	V _{CM} =1.2V
Differential input low threshold voltage	V _{TL}	-100	-	-	mV	
Input common mode voltage	V _{CM}	0.2	-	2.0	V	
Differential Input Voltage	V _{ID}	100	-	600	mV	
Input data position	F _{IN} =80MHz	t _{RSRM}	-	-	450	ps
		t _{RSLM}	-450	-	-	ps

Notice The spread spectrum should be 0% when the skew is measured.
Position of a measurement is T-CON LVDS input pin

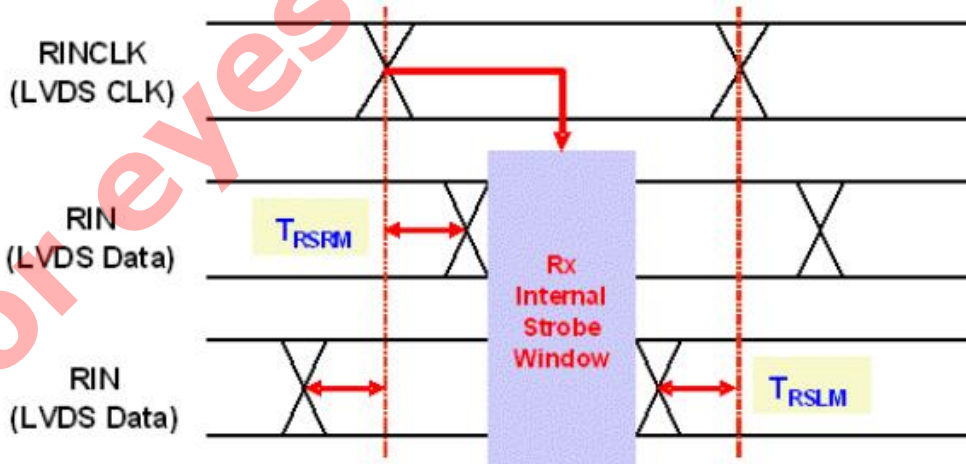
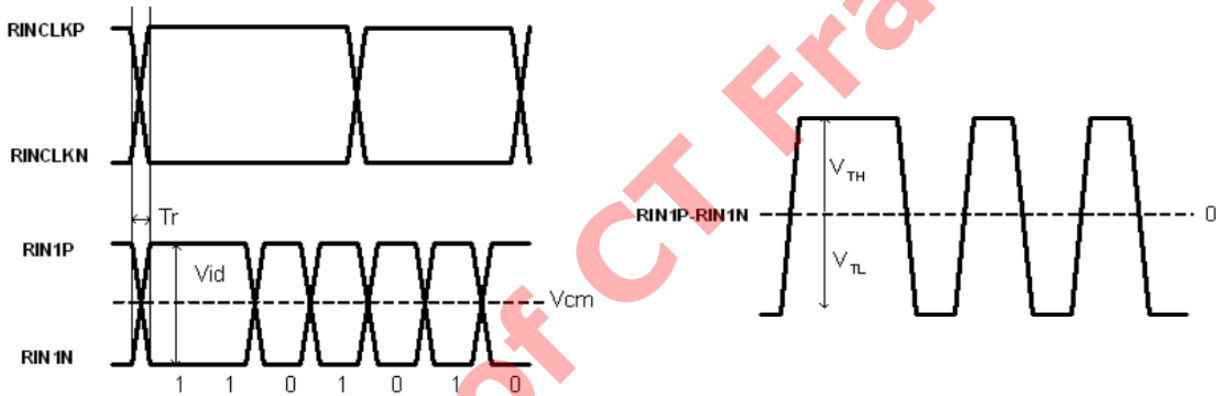

6.4 POWER ON/OFF SEQUENCE

To prevent the product from being latched up or the DC in the LCD module from starting an operation, the order to turn the power on and off should be changed to the order as shown in the diagram below.

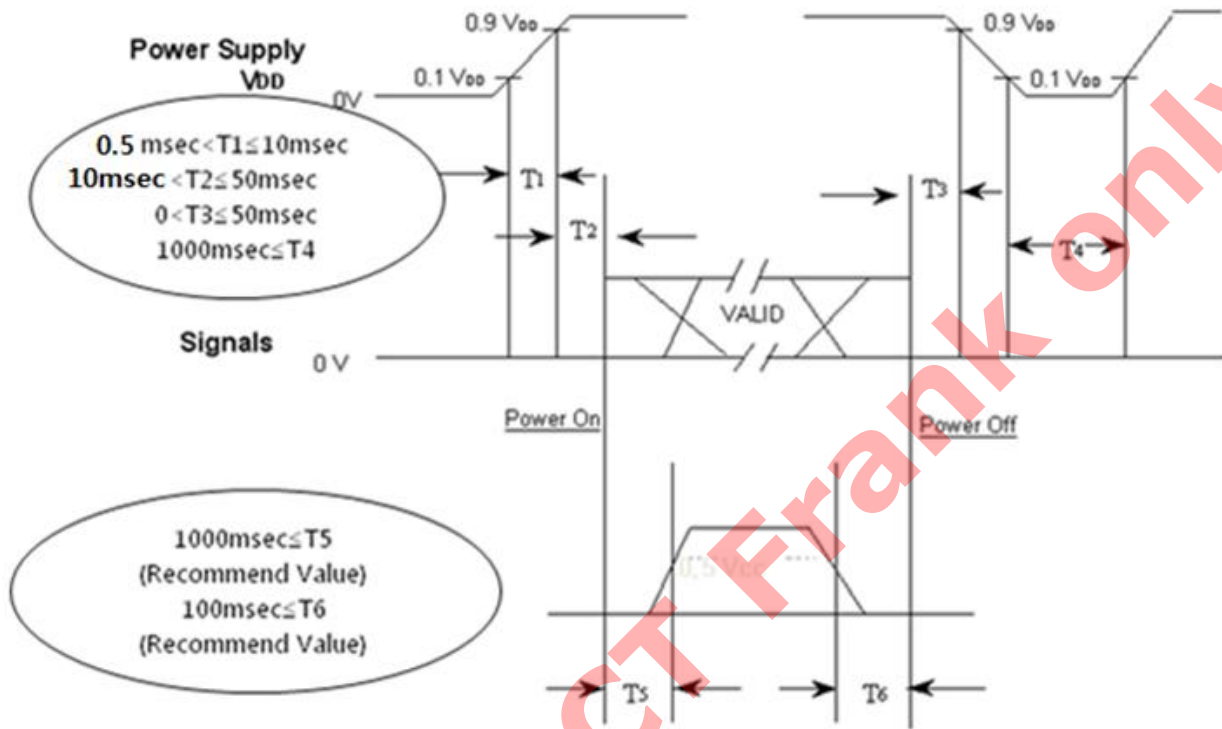

- T1 : The V_{DD} rising time from 10% to 90%
- T2 : The time from the point which V_{DD} reach to 90% of voltage to the point which the valid data is out when the power is on.
- T3: The time from the point which the valid data is out to the point which V_{DD} reach to the 90% of voltage when the power is off.
- T4: the time from the point which the V_{DD} decrease to the point which the V_{DD} increase again for windows to restart.

※ The recommended operating condition of the back light system

- T5: The time which takes for B/L to be turned on after the signal is entered when the time is on.
- T6 : The time which takes until the signal is out after BL is turned off
 - The condition of supply voltage to enter in the module from the external system should have the same condition as the definition of V_{DD}.
 - Apply the voltage for the lamp within the range which the LCD operates. when the back light is turned on before the LCD is operated or when the LCD is turned off before the back light is turned off, the display may show the abnormal screen momentarily.
 - While the V_{DD} is off level, please keep the level of input signals low or keep a high impedance condition.
 - The figure of T4 should be measured after the module has been fully discharged between the periods when the power is on and off.
 - The interface signal must not keep the high impedance condition when the power is on.

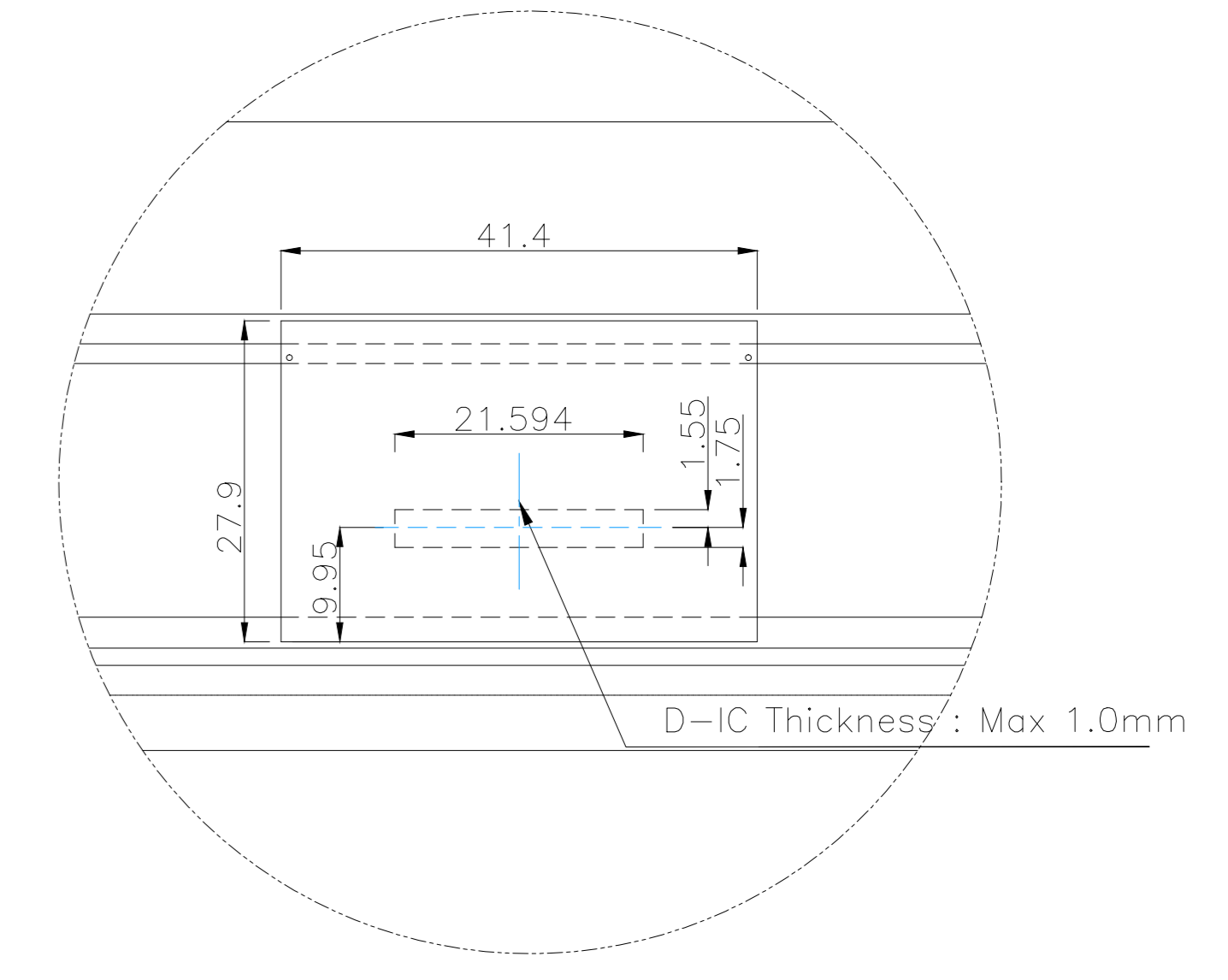
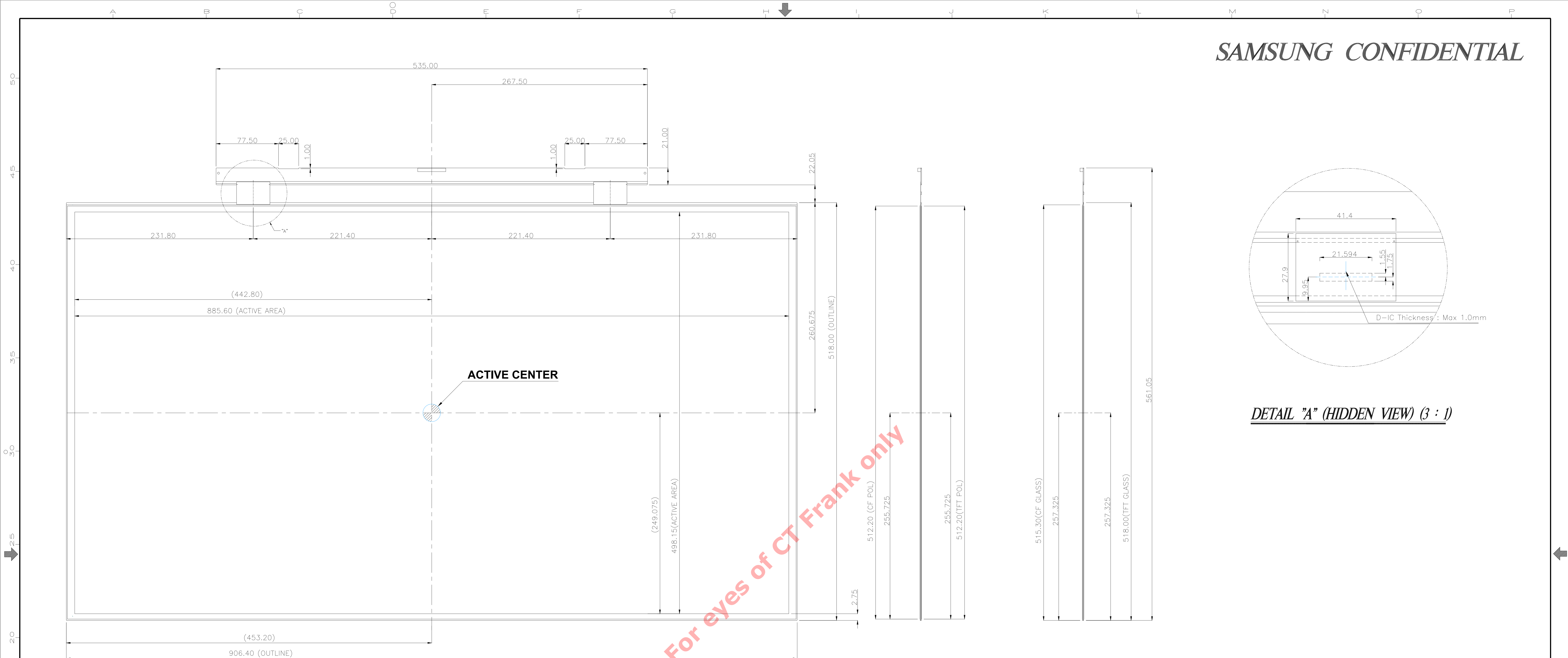

DETAIL "A" (HIDDEN VIEW) (3 : 1)

For eyes of CT Frank only

- * NOTE**
- PANEL : TFT-LCD**
 - REFER TO "PRODUCT INFORMATION" OR "PRODUCT SPECIFICATION" DOCUMENTS**
 - TOLERANCE
 - FFC CABLE INFORMATION
 - CONNECTOR INFORMATION
 - PANEL THICKNESS**
 - CF POL : T0.2
 - CF GLASS : T0.7
 - TFT GLASS : T0.7
 - TFT POL : T0.2
 - SOURCE PBA**
 - PCB THICKNESS : T1.0
 - PCB LAYER : 4
 - FFC CONNECTOR HEIGHT : T3.8
 - CIRCUIT COMPONENT MAX HEIGHT : T3.8

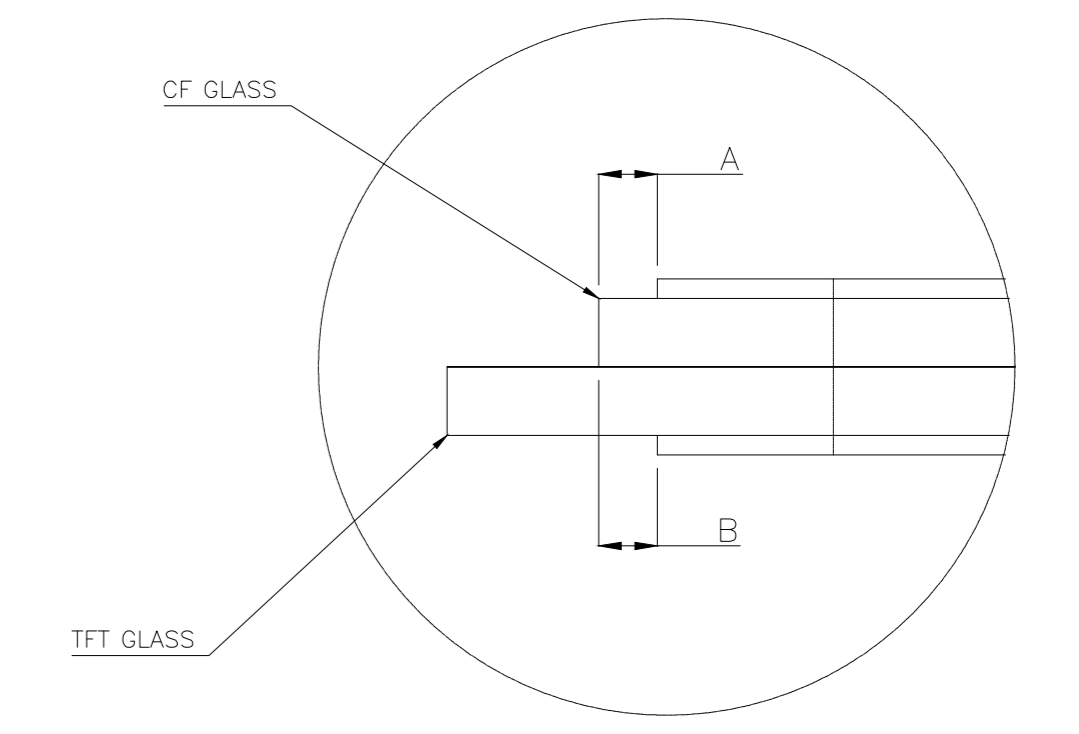

DIMENSION FOR POL STICKING

	CF GLASS ~ POL	
POSITION	A(CF POL)	B(TFT POL)
UP	1.5	1.5
DOWN	1.6	1.6
LEFT	1.3	1.3
RIGHT	1.3	1.3

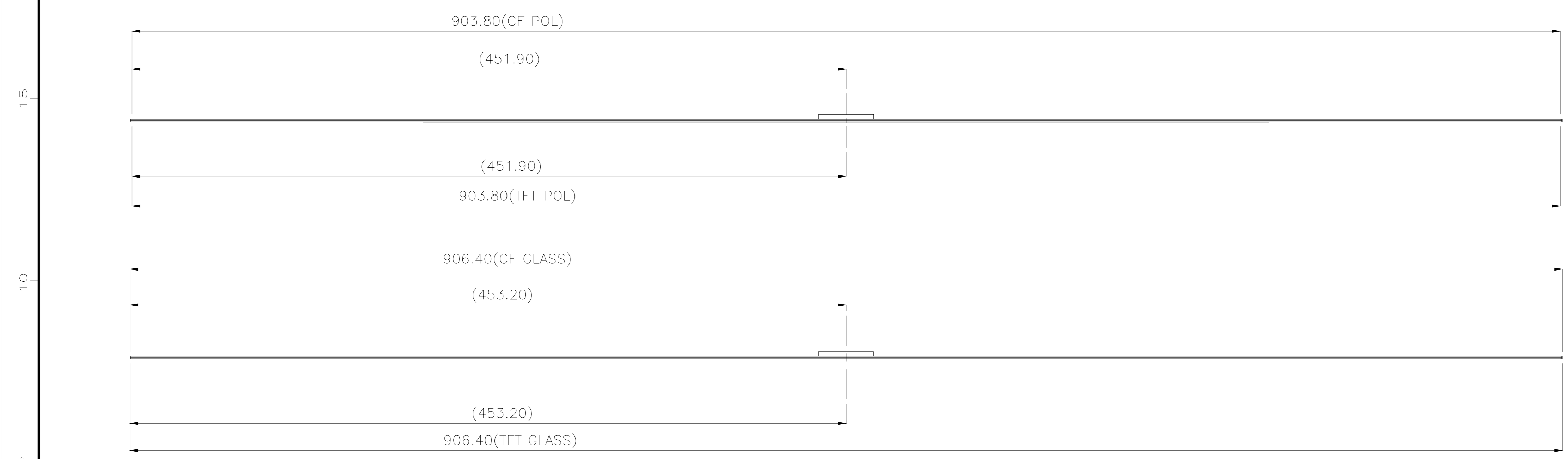

REV	DATE	DESCRIPTION OF REVISION	REASON	CHK'D BY

PRELIMINARY

GENERAL TOLERANCE				UNIT	mm	DRA'N BY	DES'D BY	CHK'D BY	APP'D BY	MODEL NAME	LSC400HM06-T
STEP	LEVEL 1	LEVEL 2	LEVEL 3	SCALE	1:1	Y.B.KIM				SHEET NAME	OUTLINE DIMENSION
0 < X <= 4	±0.05	±0.1	±0.2	TOLERANCE		XXXXXX				SPECIFICATION	FHD, 40", 60Hz, M87, NNB
4 < X <= 16	±0.08	±0.15	±0.3							SHEET	1/1
16 < X <= 64	±0.12	±0.25	±0.5							VER.	000
64 < X <= 256	±0.25	±0.4	±0.8								

SAMSUNG DISPLAY

8. PACKING

8.1 CARTON

- (1) Packing Form
Corrugated Card board box as shock absorber.
- (2) Packing Method

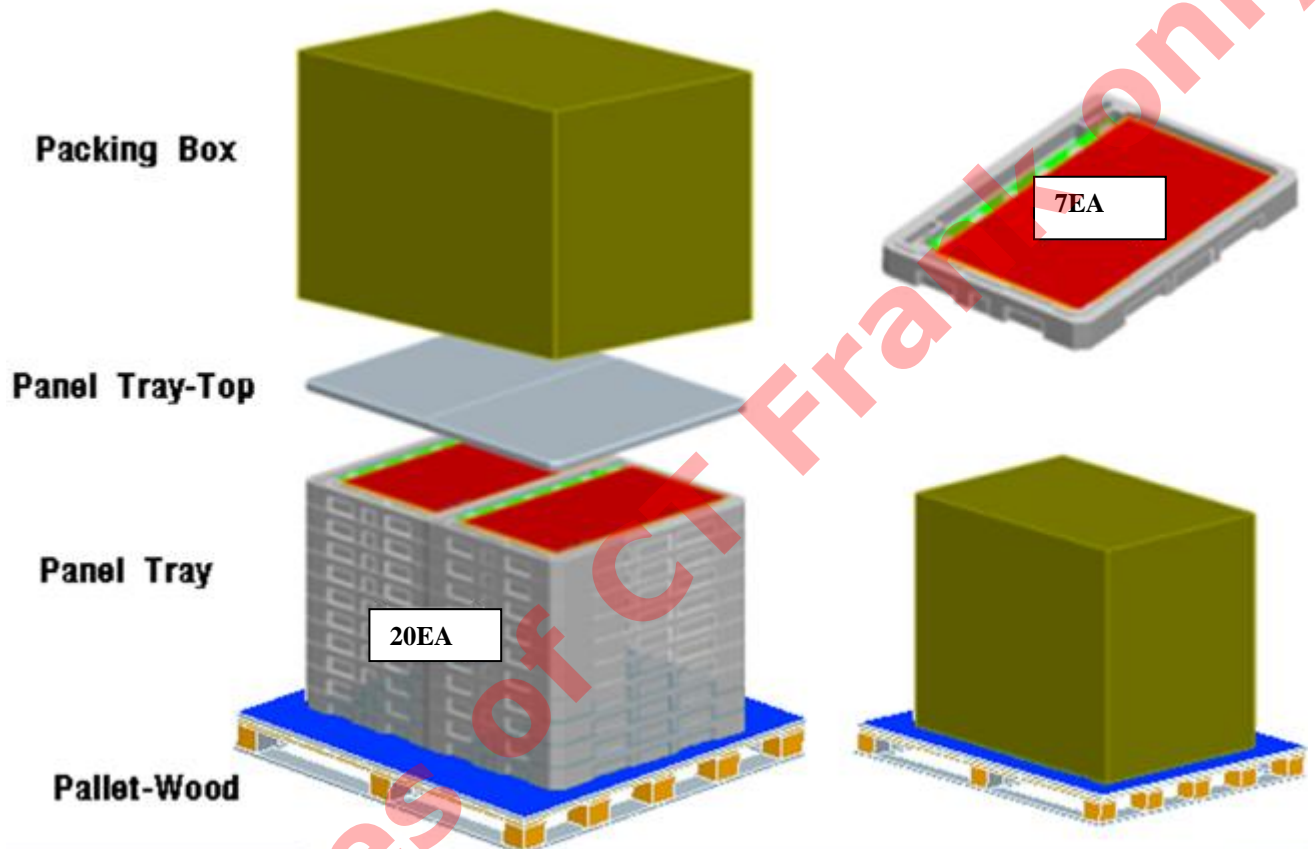

- (3) Packing Material

ITEM	Specification	Remark
Total Pallet Size	1485 X 1150 X 1192	W x V x Height [mm]
Tray	7 [Panel/Tray]	- Panel : 13.3kg(1.9kg/Panel, 7ea/Tray) - Panel Tray : 1.6kg(EPS)
Pallet	20 [Tray/Pallet]	- Pallet 28.0kg(Wood Pallet) - 20ea(10tray x 2array) + 2ea(Top tray)
Total Weight	339.0 [kg]	- Packing Box : 3kg(Paper)

8.2 MARKING

A nameplate is affixed to the specified location on each product.

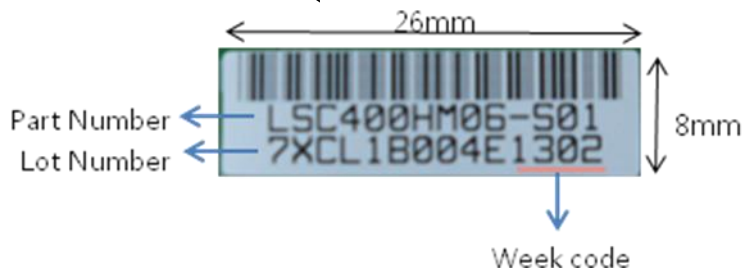

(1) Parts number : LSC400HM06

(2) Revision code : 3 letters

(3) Lot number : X X X X XXX XX X

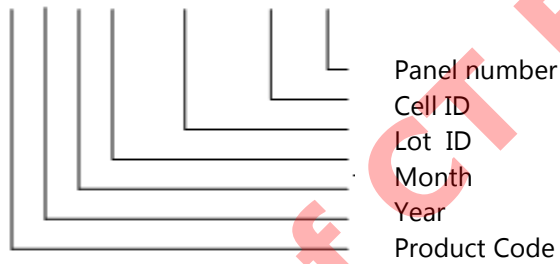

(4) Weekcode : 1205 (ex. 2012 year, 5th week)

For eyes of Frank only

(4) Nameplate Indication



Parts name : LSC400HM06
 Lot number : XXXXXXXXXX
 Product Revision Code : XXX

(5) Packing box attach



9. GENERAL PRECAUTIONS

9.1 HANDLING

- (a) When the panel kit and BLU kit are assembled, the panel kit and BLU kit should be attached to the set system firmly by combining each mounted holes. Be careful not to give the mechanical stress.
- (b) Be careful not to give any extra mechanical stress to the panel when designing the set, and BLU kit.
- (c) Be cautious not to give any strong mechanical shock and / or any forces to the panel kit.
Applying the any forces to the panel may cause the abnormal operation or the damage to the panel kit and the back light unit kit.
- (d) Refrain from applying any forces to the source PBA and the drive IC in the process of the handling or installing to the set. If any forces are applied to the products, it may cause damage or a malfunction in the panel kit.
- (e) Refrain from applying any forces which cause a constant shock to the back side of panel kit, the set Design and BLU kit. If any forces are applied to the products, it may cause an abnormal display, a functional failure and etc.
- (f) Note that polarizer could be damaged easily.
Do not press or scratch the bare surface with the material which is harder than a HB pencil lead.
- (g) Wipe off water droplets or oil immediately. If you leave the droplets for a long time on the product, a staining or the discoloration may occur.
- (h) If the surface of the polarizer is dirty, clean it using the absorbent cotton or the soft cloth.
- (i) Desirable cleaners are water or IPA (Isopropyl Alcohol).
Do not use Kenton type materials (ex. Acetone), Ethyl alcohol, Toluene, Ethyl acid or Methyl chloride. These might cause the permanent damage to the polarizer due to chemical reaction.
- (j) If the liquid crystal material leaks from the panel, this should be kept away from the eyes or mouth.
If this contacts to hands, legs, or clothes, you must washed it away with soap thoroughly and see a doctor for the medical examination.
- (k) Protect the panel kit and BLU Kit out of the static electricity. Otherwise the circuit IC could be damaged.

- Reference : Process control standard of SDC

No.	Item	Control standard
1	Ionizer	All Equipment should be controlled under 150V.(Typ. 100V)
2	Carrying Roller	Carrying Roller should be controlled under 200V.
3	Equipment Ground Resistance	All Equipment Ground Should be less than 1ohm.

- (l) Remove the stains with finger-stalls wearing soft gloves in order to keep the display clean in the process of the incoming inspection and the assembly process.
- (m) Do not pull or fold the source drive IC which connects to the source PBA and the panel or the gate drive IC.
- (n) Do not pull, fold or bend the source drive IC and the gate drive IC in any processes.
If not, the source drive IC could be bent one time in the process of assembling the panel Kit and the BLU Kit.
- (o) Do not adjust the variable resistor located on the panel kit and BLU kit except when adjusting the flicker.
- (p) Do not touch the pins of the interface connector directly with bare hands.
- (q) Be cautious not to be peeled off the protection film.

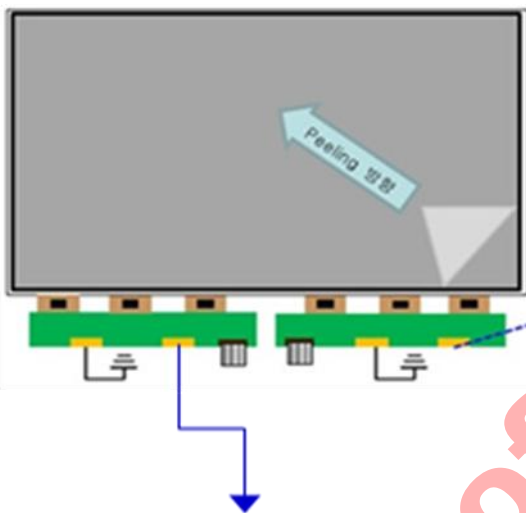

Fig. GND SR-Open Pattern – Be sure to be contacted to the ground while peeling of the protection film

- Make sure to peel off slowly (It is recommended to peel it off at the speed of more than 8sec. constantly.)
- The peeling direction is shown at the Fig
- Instruct the ground worker to work with the adequate methods such as the antistatic wrist band.
- Make sure to be grounded the source PBA while peeling of the protection film.
- Ionized air should be blown over during the peeling
- The protection film should not be contacted to the source drive IC.
- If the adhesive stains remain on the polarizer after the protection film is peeled off, please move stains with isopropyl-alcohol liquid.

- (r) The protection film for the polarizer on the panel kit should be slowly peeled off just before using so that the electrostatic charge can be minimized.
- (s) The panel kit and BLU kit have high frequency circuits. The sufficient suppression to the EMI should be done by the set manufacturers.
- (t) The set of which the panel is assembled shall not be twisted. If the product is twisted, it may cause the damage on the product.
- (u) Surface Temp. of IC should be controlled less than 100 °C, operating over the Temp. can cause the damage or decrease of lifetime.

9.2 STORAGE

The storage condition for packing

ITEM	Unit	Min.	Max.				
Storage Temperature	(°C)	5	40				
Storage Humidity	(%rH)	35	75				
Storage life	6 months						
Storage Condition	(1) The storage room should provide good ventilation and temperature control. (2) Products should not be placed on the floor, but on the Pallet away from a wall. (3) Prevent products from direct sunlight, moisture nor water; Be cautious of a buildup of condensation. (4) Avoid other hazardous environment while storing goods. (5) If products delivered or kept in conditions of the recommended temperature or humidity, we recommend you leave them at a circumstance which is shown in the following table.						
	period	1 month	2 months	3 months	4 months	5 months	6 months
	Baking Condition	No Baking		50°C, 10% 24Hr	50°C, 10%, 48Hr		

9.3 OPERATION

- (a) Do not connect or disconnect the FFC cable during the "Power On" condition.
- (b) Power supply should be always turned on and off by the "Power on/off sequence"
- (c) The module has high frequency circuits. The sufficient suppression to the electromagnetic interference should be done by the system manufacturers. The grounding and shielding methods is important to minimize the interference.
- (d) The cables between TV SET connector and Control PBA interface cable should be connected directly to have a minimized length. A longer cable between TV SET connector and Control PBA interface cable maybe operate abnormal display
- (e) Recommend to age for over 1 hour at least in the state, which the product is driving initially to stabilize the characteristic of the initial TFT.
- (f) Response time depends on the temperature.(In Lower temperature, it becomes longer)

9.4 OPERATION CONDITION GUIDE

(a) The LCD product shall be operated under normal conditions.

The normal condition is defined as below;

- Temperature : 20±15℃
- Humidity : 55±20%
- Display pattern : continually changing pattern (Not stationary)

(b) If the product will be used under extreme conditions such as under the high temperature, humidity, display patterns or the operation time etc., it is strongly recommended to contact SDC for the advice about the application of engineering. Otherwise, its reliability and the function may not be guaranteed. Extreme conditions are commonly found at airports, transit stations, banks, stock markets, and controlling systems.

9.5 PROCESS EXECUTING GUIDE

(a) Aging

Be sure to age for over 1 hour at least, which the product is driving initially to stabilize TFT Characteristic.

(b) Flicker Adjustment

- (1) Flicker should be adjusted by optimizing the Vcom value in customer LCM Line through the I2C Interface.
(Master & Slave = I2C communication)

Pin. No.	Symbol	Function	Remark
1	TCON_WP	EN	Default : 0V Vcom tuning : 3.3V (Shouldn't be communicated with I2C device as output level "5V")
2	SCL_I	I2C Interface	I2C Bus Interface
3	SDA_I	I2C Interface	

- (2) Flicker should be tuned by correct method according to gamma IC type of each model and (LSC400HM06 – "Genie Type")

Type	Flicker data saving position	Slave Address																
Genie Type	Gamma IC memory	<table border="1" style="font-size: small;"> <tr> <td>B7</td><td>B6</td><td>B5</td><td>B4</td><td>B3</td><td>B2</td><td>B1</td><td>B0</td> </tr> <tr> <td>1</td><td>0</td><td>0</td><td>1</td><td>1</td><td>1</td><td>1</td><td>R/W-</td> </tr> </table> <p>Write B0 = "0"/Read B0 = "1"</p>	B7	B6	B5	B4	B3	B2	B1	B0	1	0	0	1	1	1	1	R/W-
B7	B6	B5	B4	B3	B2	B1	B0											
1	0	0	1	1	1	1	R/W-											
Genie-lite Type	T-con EEPROM	1110101 (EEPROM data Address : 8161)																

- (3) Flicker should be adjusted the pattern, where are displayed alternately at green sub-pixel. (Green 1*1 Dot Pattern)

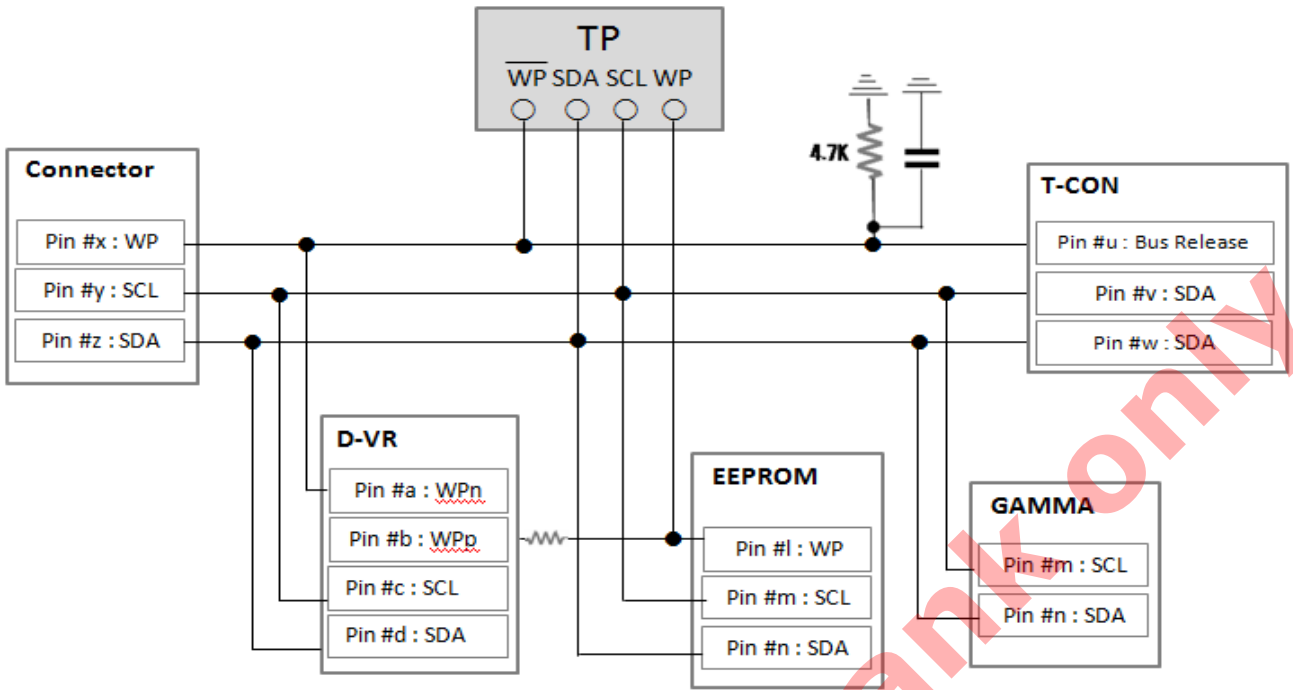

< Flicker Adjust Circuit Block Diagram >

9.6 OTHERS

- (a) The ultra-violet ray filter is necessary for the outdoor operation.
- (b) Avoid the condensation of water which may result in the improper operation of product or the disconnection of electrode.
- (c) Do not exceed the limit on the absolute maximum rating. (For example, the supply voltage variation, the input voltage variation, the variation in content of parts and environmental temperature, and so on) If not, panel may be damaged.
- (d) If the module keeps displaying the same pattern for a long period of time, the image may be remained to the screen. To avoid the image sticking, it is recommended to use a screen saver.
- (e) This Panel has its circuitry of PCB's on the rear side, so it should be handled carefully in order for a force not to be applied.
- (f) Please contact the SDC in advance when the same pattern is displayed for a long time

10. SPECIAL PRECAUTIONS

No	Component	Expected cause
1	Upholding part for panel	Prevent the panel from breaking by assigning gaps between the panel and the upholding part for panel on the drawing for the upholding part for panel. Refer to the (a), (b), (c) of 3-1 for the design of BLU.
2	The shape of the upholding part for panel	Design the upholding part for panel to fit to the panel appropriately when designing the BLU since the shape of the upholding part for panel may damage the panel. Refer to the (a), (b), (c) of 3-1 for the design of BLU.
3	The edge of upholding part for panel	Design the edge of panel to have a sufficient space with the upholding part for panel when designing the BLU since the edge of the upholding part for panel may damage the panel when assembling the panel and BLU. Refer to the (a), (b), (c) of 3-1 for the design of BLU.
4	Upholding part for panel	Place the upholding part for the panel in order for the shape of mold, which contacts with the panel not to interfere with the area of panel. Refer to the (a), (b), (c) of 3-1 for the design of BLU.
5	Drive IC	Design the BLU in order for the COF not to contain the lead crack resulted from the tensioned COF created when the product is twisted if the space between the D-IC COF and the middle mold isn't sufficient. Refer to the (a), (b), (c),(d),(e),(f), and (g)of 3-2 for the design of BLU.
6	Drive IC	Design the BLU in order for the product not to contain the lead crack resulted from the tensioned COF caused under the condition, which the product is twisted by fixing the source PCB. Refer to the (a), (b), (c),(d),(e),(f), and (g)of 3-2 for the design of BLU.
7	IC component	1) The temperature of each part of product suggested by our company and the second vendor shall meet the standard of temperature, which is recommended not to be exceeded by our company when the product is affected under the various temperature ranges. Apply over 1mm long separation distance stated in the safety standard between the electric part and each conductor. (Apply the rated separation distance when insulating.)
8	Thermal pad	Apply the thermal pad in a designated size to the product as a measure to lower the temperature of heat in order for each part to use the rated temperature.
9	POL	The surrounding area of the POL shall be treated with an electrification treatment since the external ESD may cause a phenomenon, which the POL is coming off. In addition, the GND portion of source PBA shall be grounded.
10	PBA	The GND portion of each PBA shall be contacted with the GND portion of BLU. Refer to the (a) and (b) of 3-3 for the design of BLU.
11	Circuit	The standardized approval from the client is required since the EMI is executed by a client. Our company can only measure the reference since the client measures the BLU.
12	The height of component	Design the BLU with considering the maximum height of parts, which our company suggests.
13	Between the FFC and the C-PBA	Design the instrument with considering the length between the FFC and the control PBA. (The marginal minimum length of 5mm or 8mm is required.)
14	Panel	The surface temperature of panel shall be maintained within 0°C and 45°C when the external ambient temperature is at 25°C. (Design the BLU with considering the increase of the temperature in the panel by the LED, CCFL, and etc.)
15	Aging	Recommend to age for over 1 hour at least in the state, which the product is driving initially to stabilize the characteristic of the initial TFT.
16	The attachment of gasket	The additional confirmation by our company is required if the attachment of gasket to the S-PBA of our company is required.(To fix the S-PBA or the EMI)
17	Drive IC	Design the top chassis and the driver IC to be contacted by placing the shape of emboss inside the top chassis as a measure to prevent the driver IC from heating. The size of emboss shall be designed in larger size than the size of IC inside the film of the driver IC. Refer to the (a), (b), (c),(d),(e),(f), and (g)of 3-2 for the design of BLU.
18	The prohibited bandwidth	Design the BLU in order for the BLU not to interfere with the area, where the control PBA and the source PBA are located densely according to the drawing for the BLU from our company.
19	S-PBA	The material, which contacts with the bottom side of S-PBA which has a pattern shall be non-conducting material or shall be insulated.

APPENDIX – RECOMMENDATION FOR THE BLU DESIGN

1. The schematic of panel

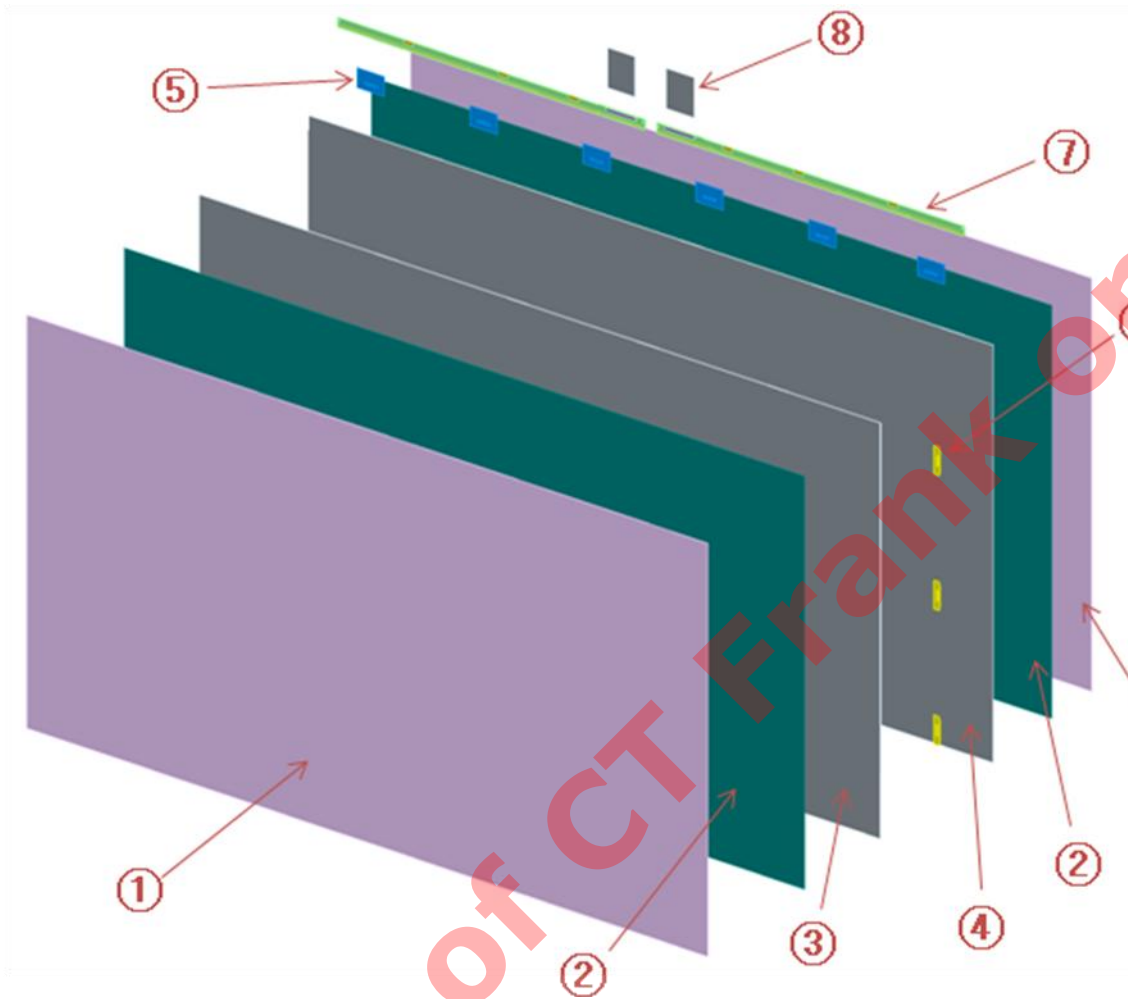

Item	Symbol	Remark
Protector Film	①	Removable
Polaroid Film	②	
Color Filter Glass	③	
TFT Glass	④	
Source IC	⑤	
Gate IC	⑥	
Source PBA	⑦	
FFC	⑧	

2. The tolerance of panel assembly

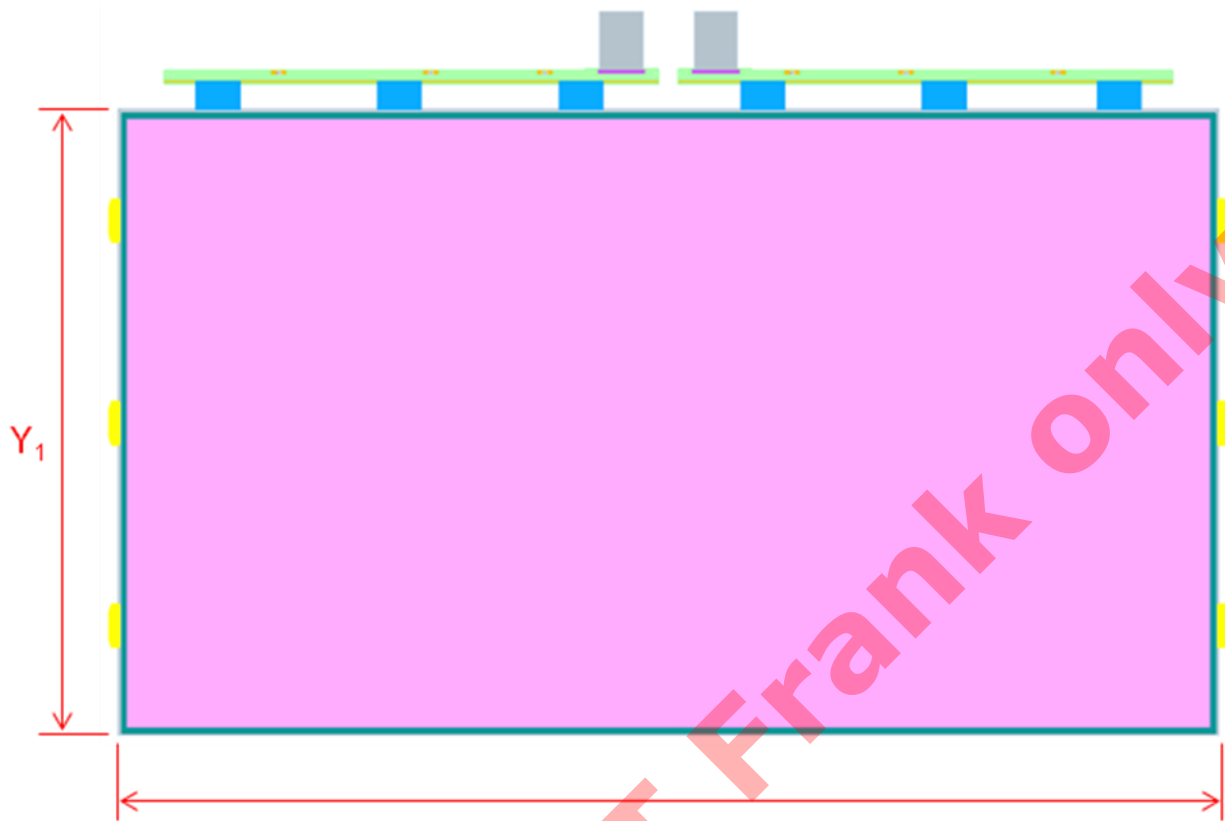

Item	Symbol	Min.	Note
Glass Cutting	X_1	± 0.3	
	Y_1	± 0.3	

3. The guide for the mechanical design

3.1 The panel guide

(a) It is recommended to avoid the following cases since the light leakage can be caused by the pressure of the guiding structure.

When the guiding part is made of plastic resin, the gap between the panel and the guiding structure should be considered when you design. The shrinkage under the situation which the temperatures change causes the light leakage. For your reference, it is recommended to have a total gap between the panel and the guide structure as below (When the resin is composed of the PC and the 15% of G/F.)

단위		32"	40"	46"	55"
Total Gap	Right & Left	0.9	0.9	1.0	1.1
	Top & Bottom	0.6	0.7	0.8	0.9

It is recommended to follow the dimension and the shape of the guiding structure stated as below since the distortion of guiding parts can cause the light leakage

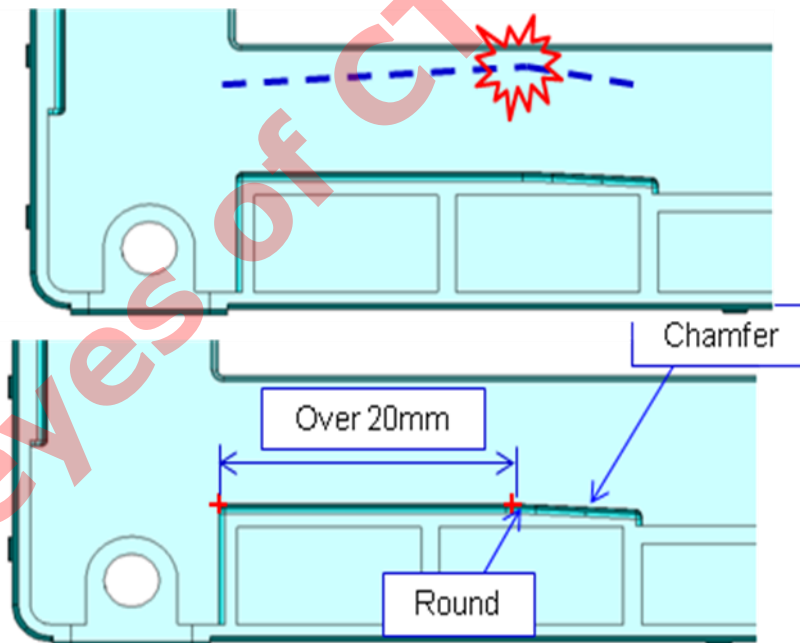

(b) When the panel guide point is designed at the edge of the panel, the points in the corner shall not be designed to be contacted with the other parts in order to avoid the crack on the panel caused by the burr of the panel.

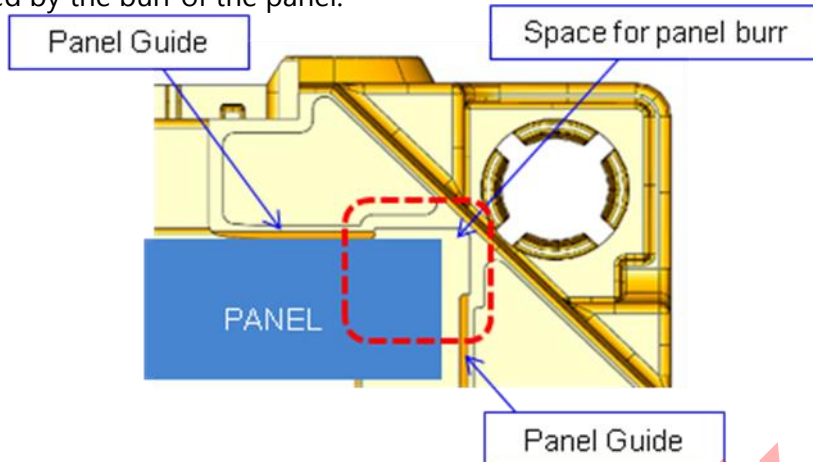

(c) It is recommended to avoid placing the ribs as shown below since the panel damage with the unstable design can be easily happened under the external force.
 -. The sharp or the round shape near the panel shall be changed to a flat shape, such as the shape of screw point, the date point, and etc.

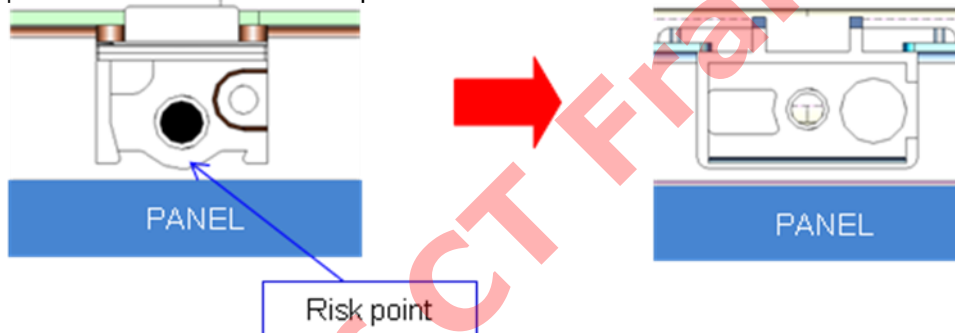

-. It is recommended to keep the gap between the panel guides and ribs over 1mm in the worst conditions.
 (※ The suggested dimension does not guarantee the quality of the products.)

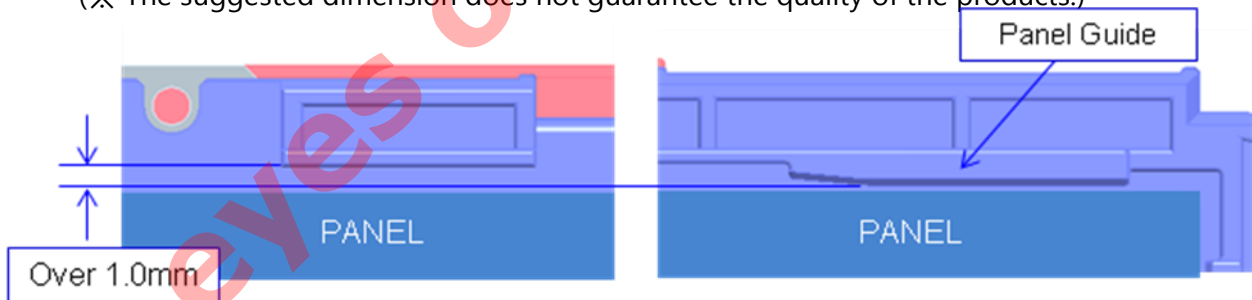

-. The gap between the panel guide and the front cover (or the front chassis) should be a zero in Z-direction to avoid the being broken in the panel caused by being stuck between the gap.

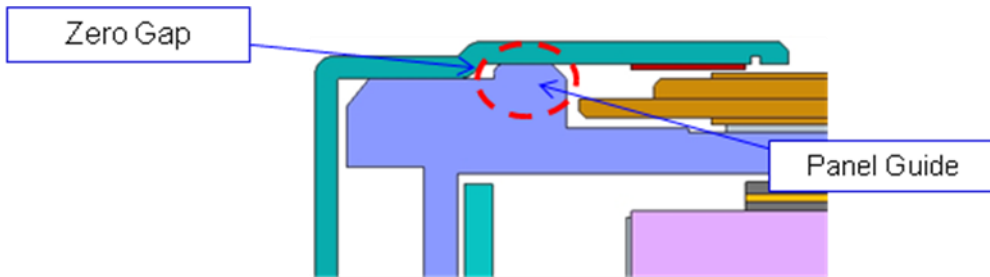

3.2 The COF and the Drive IC

(a) The pattern of COF is easily damaged by the sharp edge of the press and the burr of mold under the condition which the products are shaking while delivering. Therefore, it is recommended to avoid designing not to locate the gate of mold or the parting line in the position of COF when designing the product.

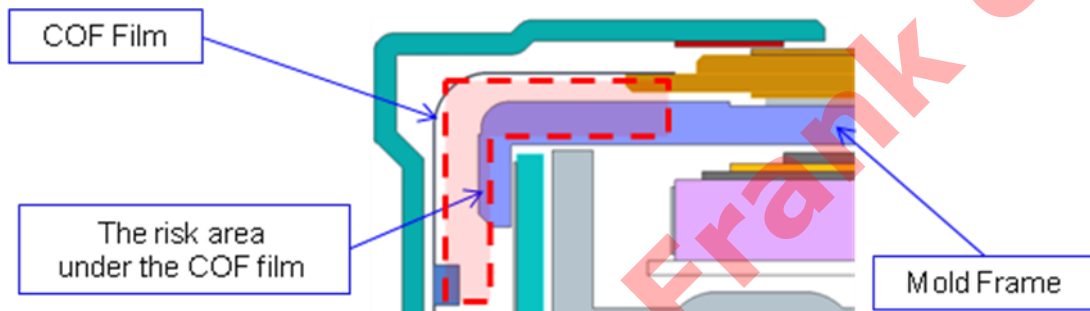

(b) It is recommended to secure the sufficient gap between the COF and the other parts when designing the product since the lack of gap between the COF and the other parts can cause the damage in the COF such as the lead crack under the condition which the product is twisted.

(※ The space over 3.0mm for moving is recommended, but the quality of products is not guaranteed.)

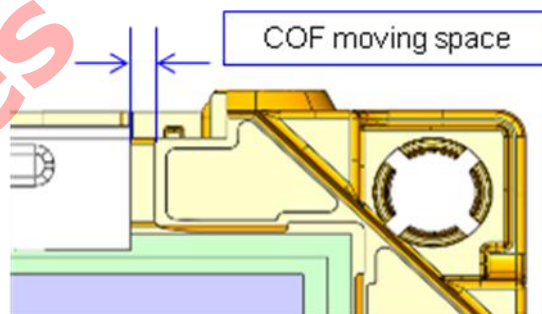

(c) The temperature of the surface of Drive-IC should be less than 100°C

- (d) The sufficient space for the COF and the Drive IC should be prepared including the worst condition to prevent the damage on Drive-IC from the external force.
 - If the panel is placed to the upper part of the mold, it is recommended to keep the gap between the mold and the front cover or the mold and the top chassis by adding the rib between the COF and COF.

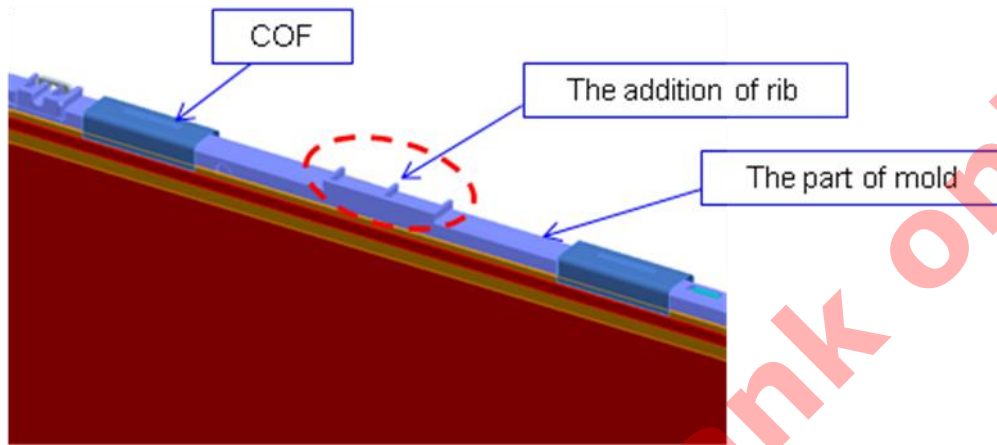

- Design the gap between the rib and the cover to maintain the space for the protection of COF as small as possible

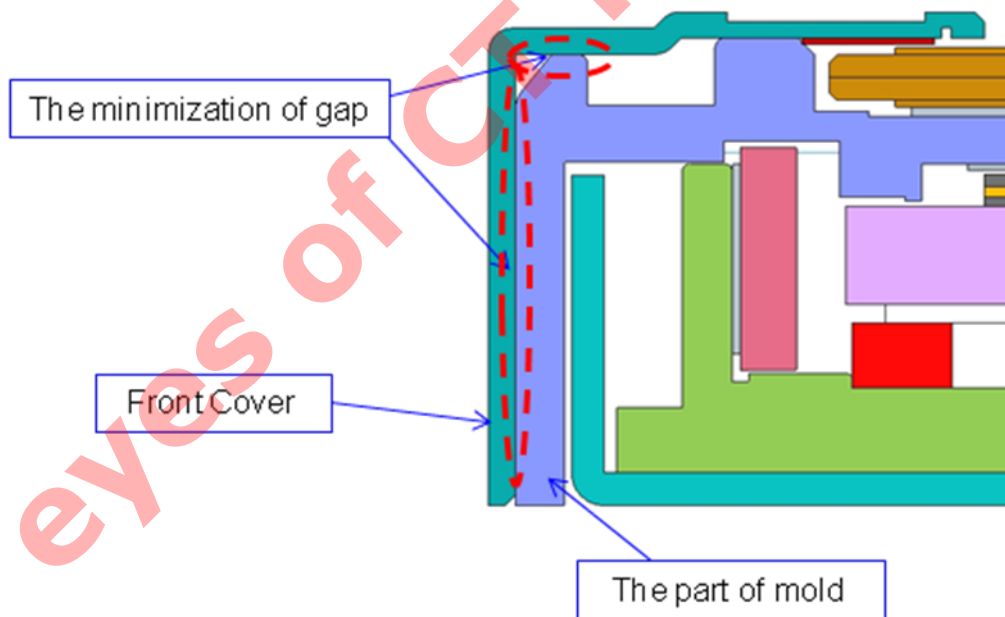

(e) When metal parts are assembled next to the Drive-IC, the metal part should be insulated to avoid the damage on IC from the static electricity.

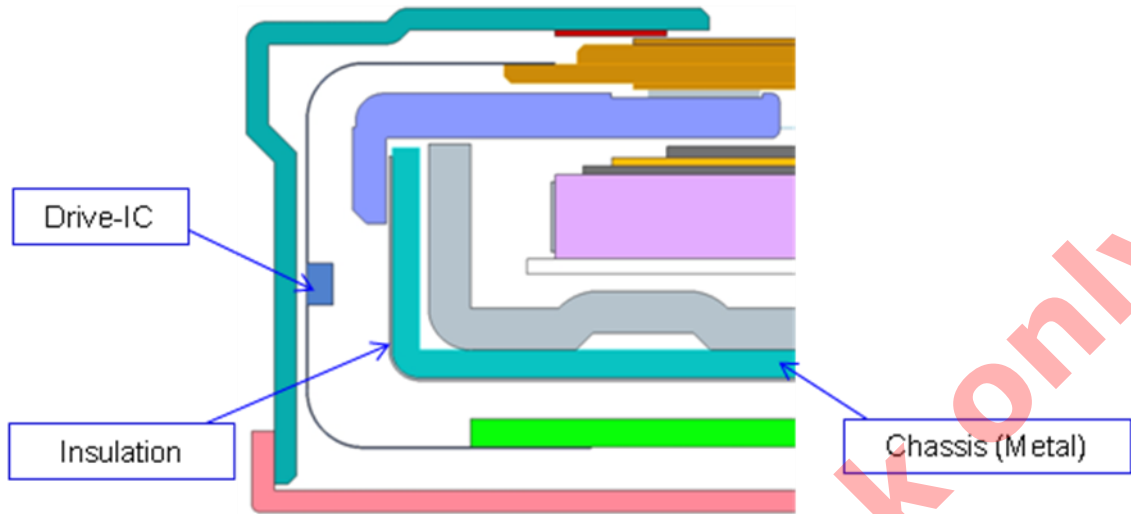

(f) If the length of COF is designed to be short, the lead crack can be occurred by applying the tension on the COF due to the being shaking of the product.

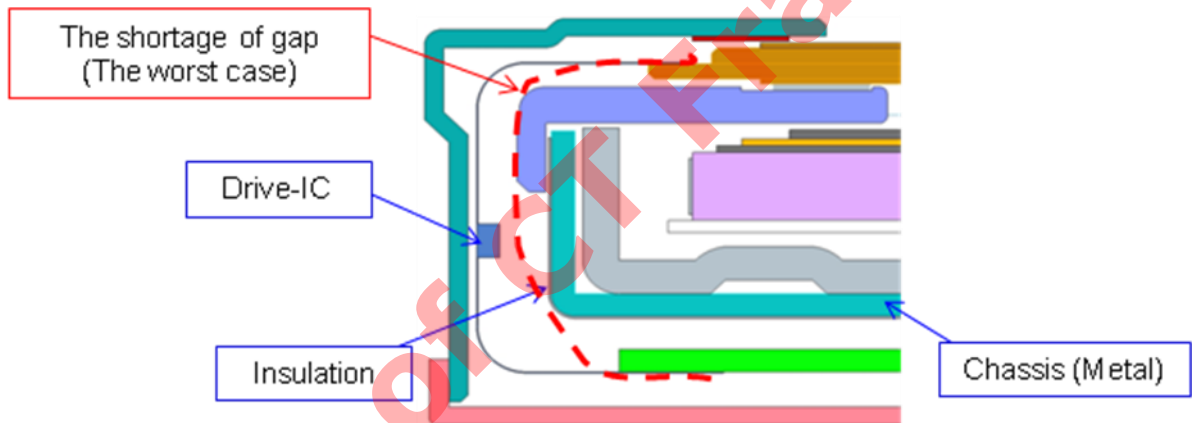

(g) It is recommended to design source PCB can be easily moved to the direction of each axis in order for the tension not to be applied to the edge of COF under vibrating condition, such as transportation of the product.

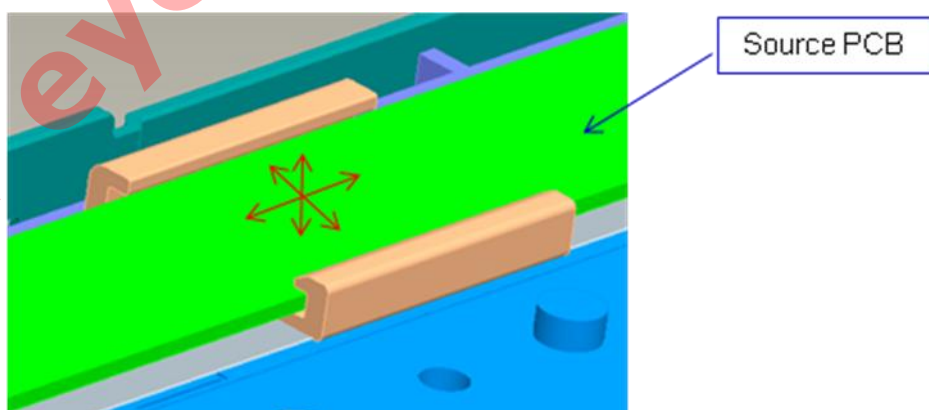

3.3 The control PBA and the Source PBA

- (a) The gaps between the source PBA and the other parts and the control PBA and other parts should be considered to avoid the damage on electrical parts by the static electricity and the external forces. If the material of shielding part is metal, the insulation method is recommended.

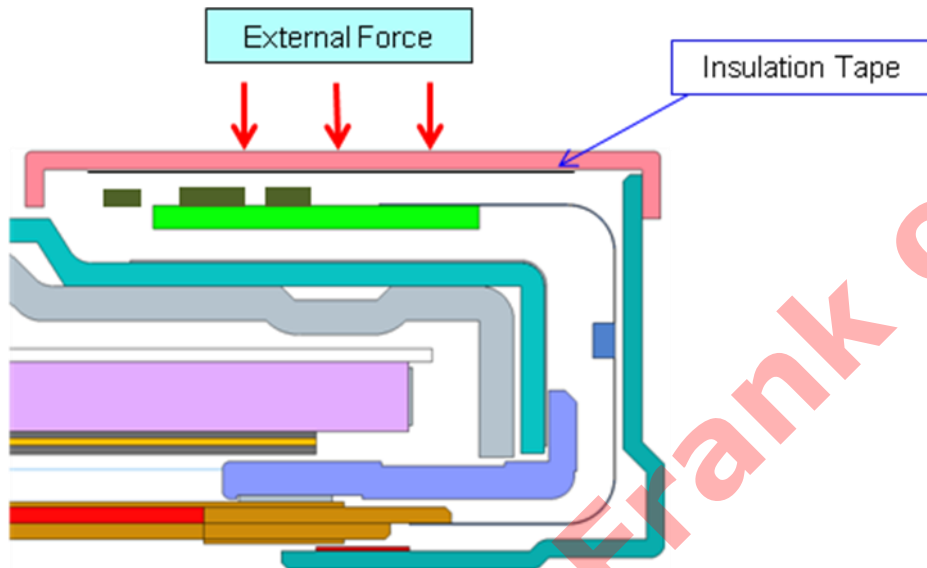

- (b) Confirm the status of insulation tape since the inappropriately attached insulation tape can cause the damage on the parts of product if the insulation tape for the insulation of part of PBA is attached inconsecutively due to the inappropriate design or the error occurred during the process.

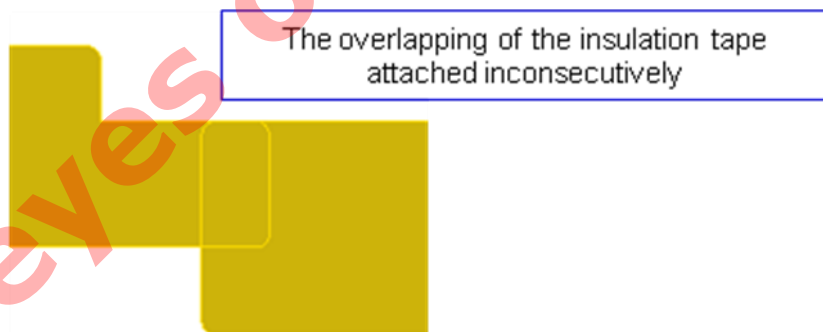

3. 4 The 4-Corner and the cloudy light leakage

(a) It is recommended to follow the method delineated in the picture below for designing since the distortion on panel and the sharp increase of the temperature gradient in the surface of panel can cause the light leakage.

- Place the strong beads at the corner point to control the flatness of the panel.

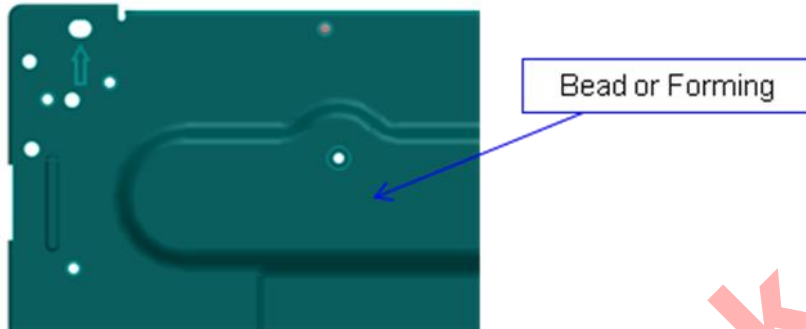

- The heat sinking plane in the lower parts shall contact with the bottom chassis.

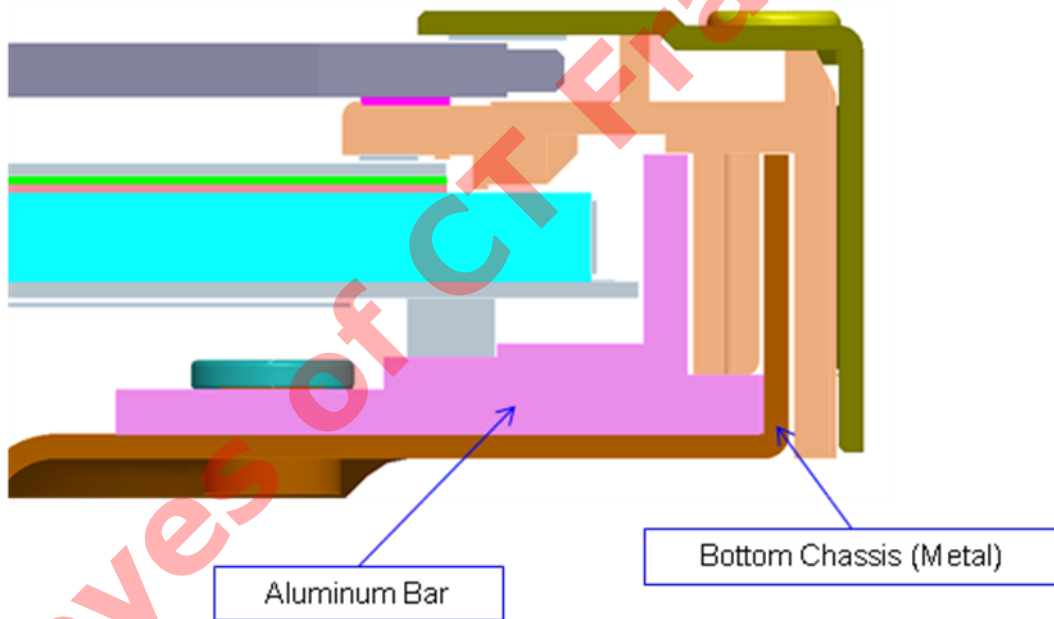

3.5 Others

(a) The corrosion of the source PBA

Be cautious when selecting the specification of tape or designing the product since the corrosion of the parts of circuit caused by the overuse of the glass cleaner of the end user may cause the occurrence of the abnormalities in the screen, if the model is the reversed product which has the source PBA designed at the 90°.

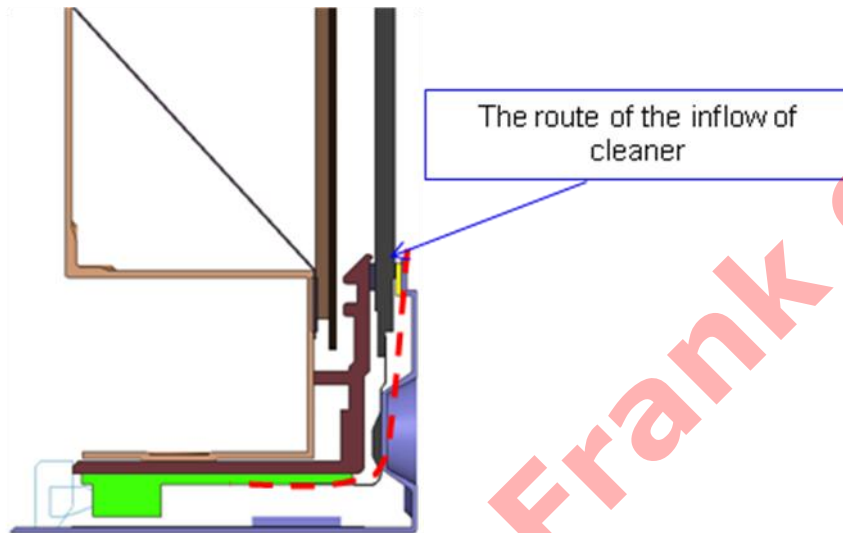

(b) The deterioration of crystal liquid

It is recommended to design the products to make the temperature of the active area of the product operated below the 50°C for the protection from containing the abnormalities in the screen due to the deterioration of the liquid crystal. In addition, it is recommended to design the product not to cause the occurrence of the deterioration of liquid crystal under the ambient temperature of 50 °C.