

### Besondere Merkmale

- nicht eingefärbtes, klares Gehäuse
- antiparallel geschaltete Leuchtdiodenchips
- hohe Signalwirkung durch Farbwechsel der LED möglich
- bei geeigneter Ansteuerung mit IC (z.B. SDA 2231), Farbwechsel von grün über gelb und orange bis super-rot möglich
- beide Farben getrennt ansteuerbar
- gegurtet lieferbar
- Störimpulsfest nach DIN 40839

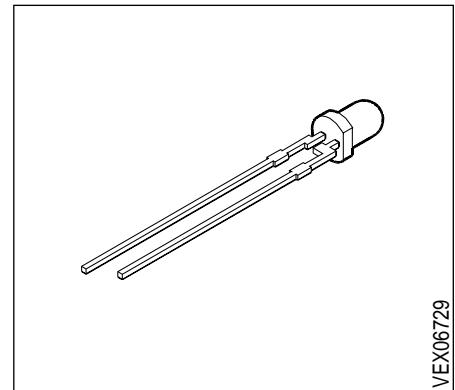

### Features

- colorless clear plastic package
- antiparallel chips
- high signal efficiency possible by color change of the LED
- with appropriate controlling by IC (e.g. SDA2231) it is possible to change color from green to yellow, orange and super-red
- both colors can be controlled separately
- available taped on reel
- load dump resistant acc. to DIN 40839

Typ Type	Emissionsfarbe Color of Emission	Gehäusefarbe Color of Package	Lichtstärke Luminous Intensity $I_F = 10 \text{ mA}$ $I_V \text{ (mcd)}$	Bestellnummer Ordering Code
LSG 3331-JO <sup>1)</sup>	super-red / green	colorless clear	$\geq 4$ (18 typ.)	Q62703-Q2296

Streuung der Lichtstärke in einer Verpackungseinheit  $I_{V \max} / I_{V \min} \leq 2.0^{1)}$ .

Streuung der Lichtstärke in einer LED  $I_{V \max} / I_{V \min} \leq 3.0$ .

<sup>1)</sup> Bei MULTILED® bestimmt die Helligkeit des jeweils dunkleren Chip in einem Gehäuse die Helligkeitsgruppe der LED.

Luminous intensity ratio in one packaging unit  $I_{V \max} / I_{V \min} \leq 2.0^{1)}$ .

Luminous intensity ratio in one LED  $I_{V \max} / I_{V \min} \leq 3.0$ .

<sup>1)</sup> In case of MULTILED®, the brightness of the darker chip in one package determines the brightness group of the LED.

**Grenzwerte<sup>1)</sup>**  
**Maximum Ratings<sup>1)</sup>**

Bezeichnung Parameter	Symbol Symbol	Werte Values	Einheit Unit
Betriebstemperatur Operating temperature range	$T_{op}$	- 55 ... + 100	°C
Lagertemperatur Storage temperature range	$T_{stg}$	- 55 ... + 100	°C
Sperrschichttemperatur Junction temperature	$T_j$	+ 100	°C
Durchlaßstrom Forward current	$I_F$	40	mA
Stoßstrom Surge current $t \leq 10 \mu s, D = 0.005$	$I_{FM}$	0.5	A
Verlustleistung Power dissipation $T_A \leq 25 \text{ °C}$	$P_{tot}$	140	mW
Wärmewiderstand Thermal resistance Sperrschicht / Luft Junction / air	$R_{th JA}$	400	K/W

- 1) Die angegebenen Grenzdaten gelten für den Chip, für den sie angegeben sind, unabhängig vom Betriebszustand des anderen.  
 1) The standard maximum ratings refer to the specified chip regardless of the other one's operating status.

## Kennwerte ( $T_A = 25\text{ °C}$ )

### Characteristics

Bezeichnung Parameter	Symbol Symbol	Werte Values		Einheit Unit
		LS	LG	
Wellenlänge des emittierten Lichtes Wavelength at peak emission $I_F = 20\text{ mA}$	(typ.) $\lambda_{\text{peak}}$	635	565	nm
Dominantwellenlänge Dominant wavelength $I_F = 20\text{ mA}$	(typ.) $\lambda_{\text{dom}}$	628	570	nm
Spektrale Bandbreite bei 50 % $I_{\text{rel max}}$ Spectral bandwidth at 50 % $I_{\text{rel max}}$ $I_F = 20\text{ mA}$	(typ.) $\Delta\lambda$	45	25	nm
Abstrahlwinkel bei 50 % $I_V$ (Vollwinkel) Viewing angle at 50 % $I_V$	$2\varphi$	40	40	Grad deg.
Durchlaßspannung Forward voltage $I_F = 10\text{ mA}$	(typ.) $V_F$ (max.) $V_F$	2.0 2.6	2.0 2.6	V V
Kapazität Capacitance $V_R = 0\text{ V}, f = 1\text{ MHz}$	(typ.) $C_0$	27		pF
Schaltzeiten: Switching times: $I_V$ from 10 % to 90 % $I_V$ from 90 % to 10 % $I_F = 100\text{ mA}, t_p = 10\text{ }\mu\text{s}, R_L = 50\text{ }\Omega$	(typ.) $t_r$ (typ.) $t_f$	300 150	450 200	ns ns

Relative spektrale Emission  $I_{rel} = f(\lambda)$ ,  $T_A = 25\text{ °C}$ ,  $I_F = 20\text{ mA}$

### Relative spectral emission

$V(\lambda)$  = spektrale Augenempfindlichkeit

Standard eye response curve

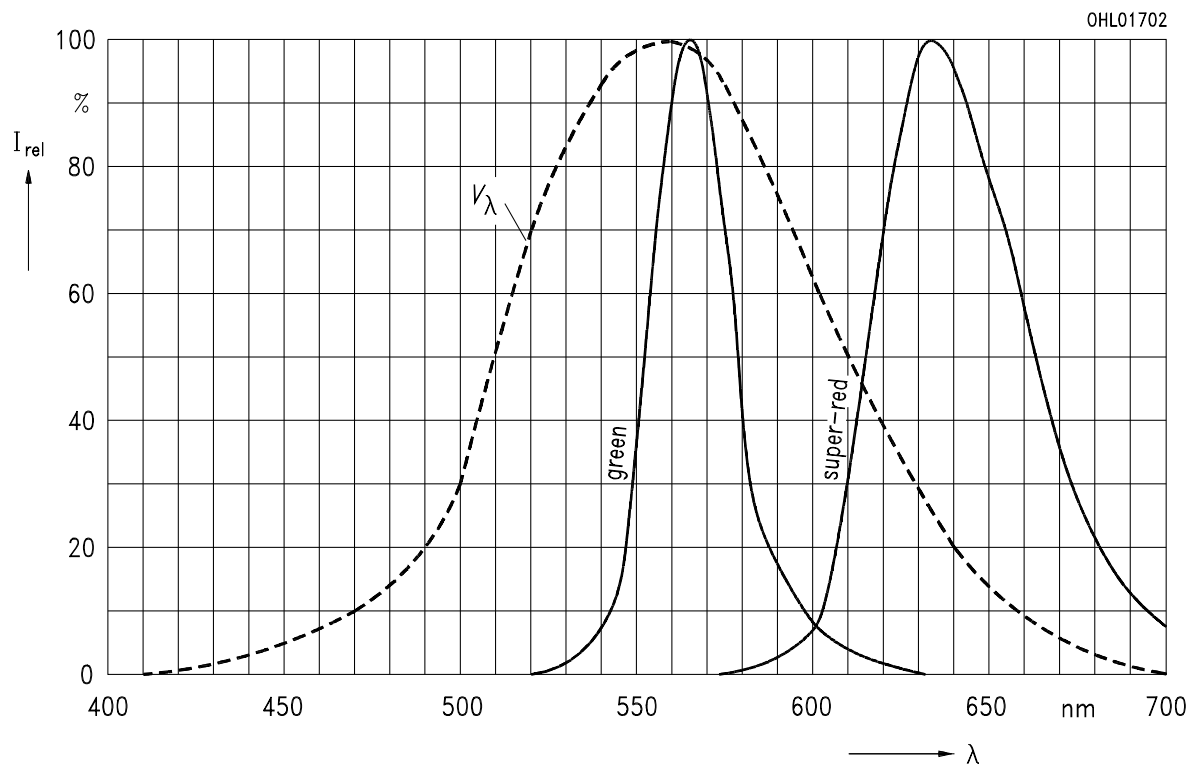

Abstrahlcharakteristik  $I_{rel} = f(\varphi)$

### Radiation characteristic

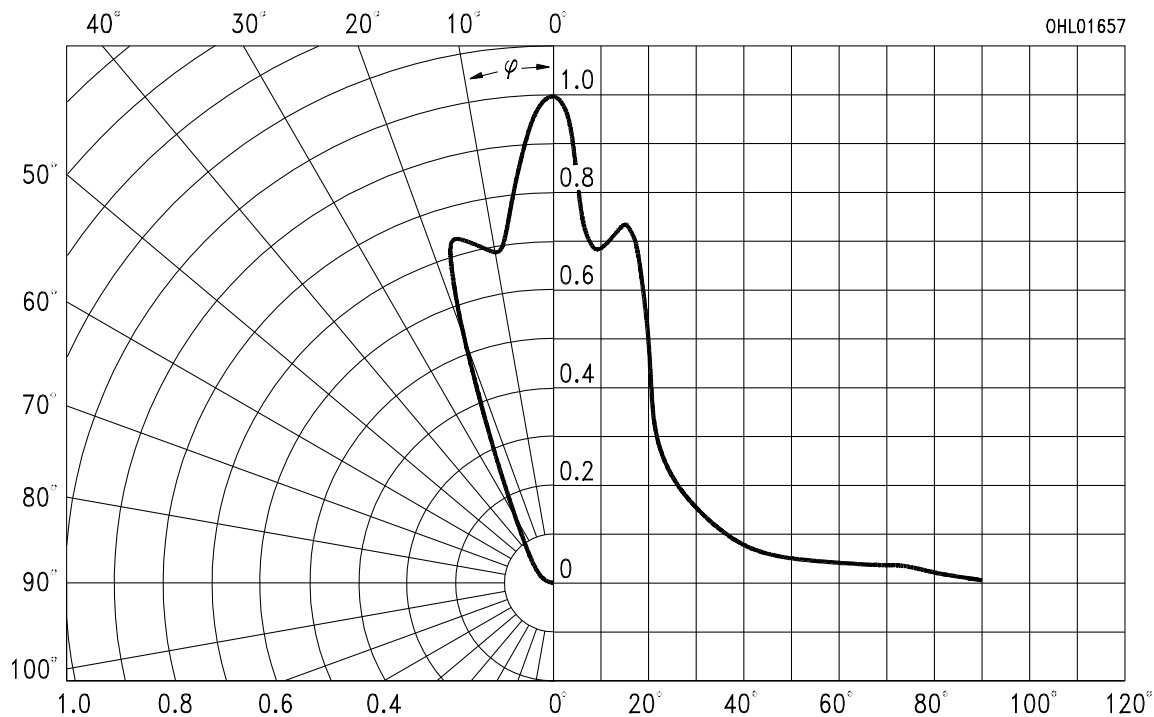

### Durchlaßstrom $I_F = f(V_F)$

#### Forward current

$T_A = 25\text{ °C}$

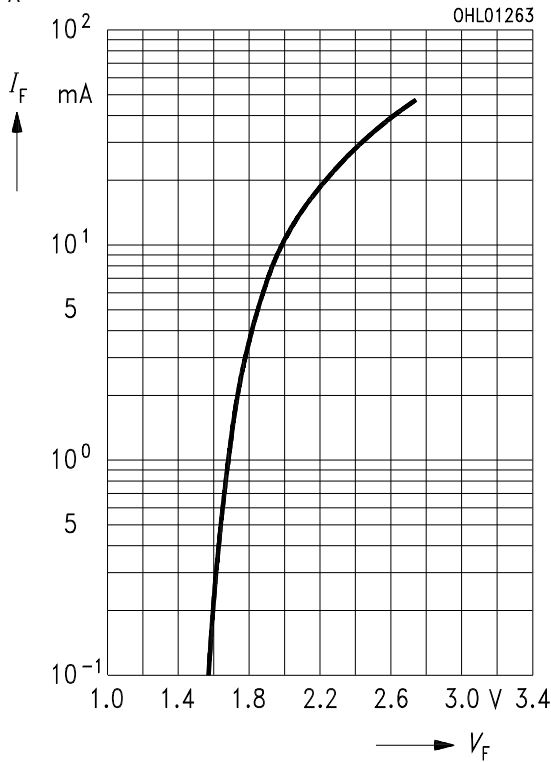

### Relative Lichtstärke $I_V/I_{V(10\text{ mA})} = f(I_F)$

#### Relative luminous intensity

$T_A = 25\text{ °C}$

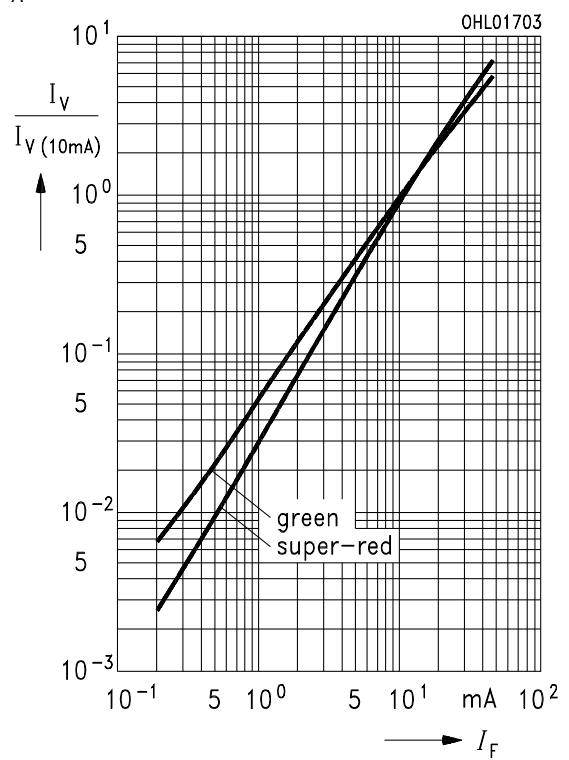

### Zulässige Impulsbelastbarkeit $I_F = f(t_P)$

#### Permissible pulse handling capability

Duty cycle  $D =$  parameter,  $T_A = 25\text{ °C}$

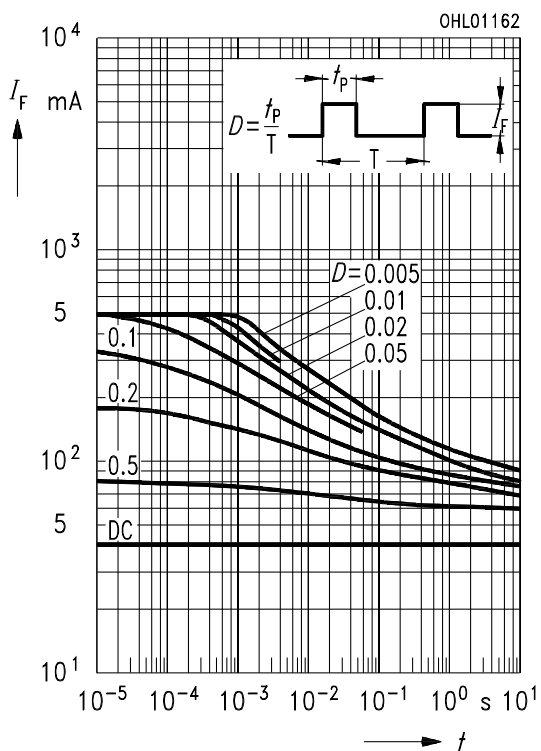

### Maximal zulässiger Durchlaßstrom

#### Max. permissible forward current

$I_F = f(T_A)$

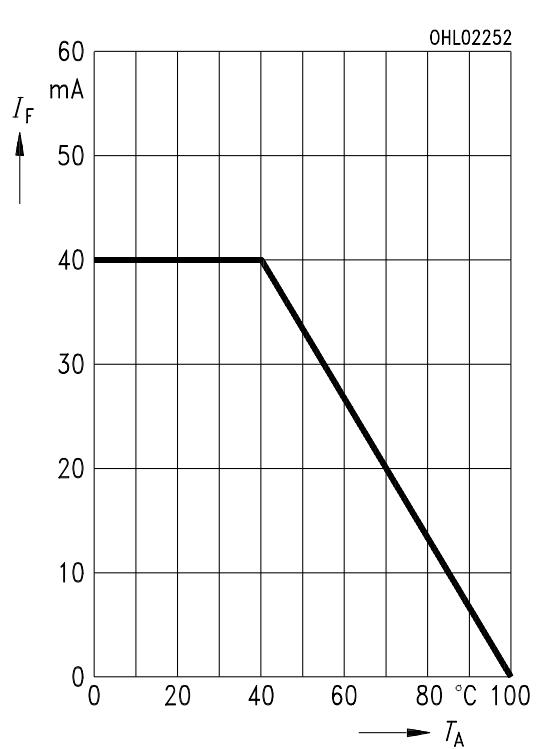

**Wellenlänge der Strahlung  $\lambda_{\text{peak}} = f(T_A)$**   
**Wavelength at peak emission**

$I_F = 20 \text{ mA}$

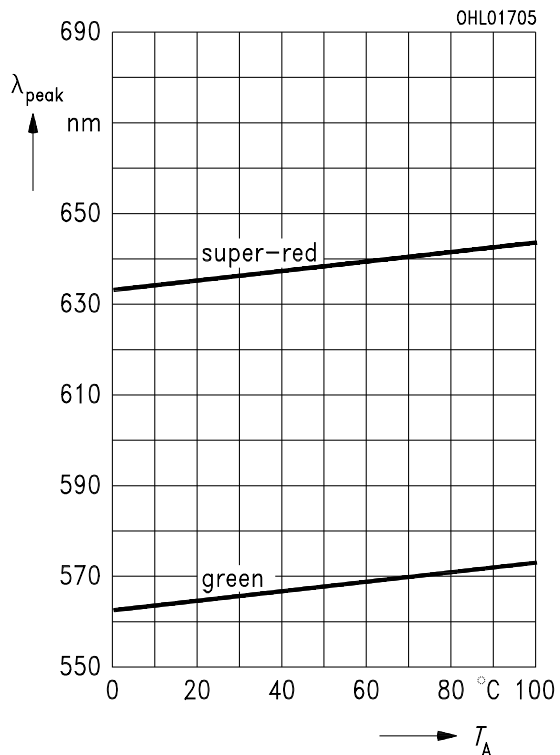

**Dominantwellenlänge  $\lambda_{\text{dom}} = f(T_A)$**   
**Dominant wavelength**

$I_F = 20 \text{ mA}$

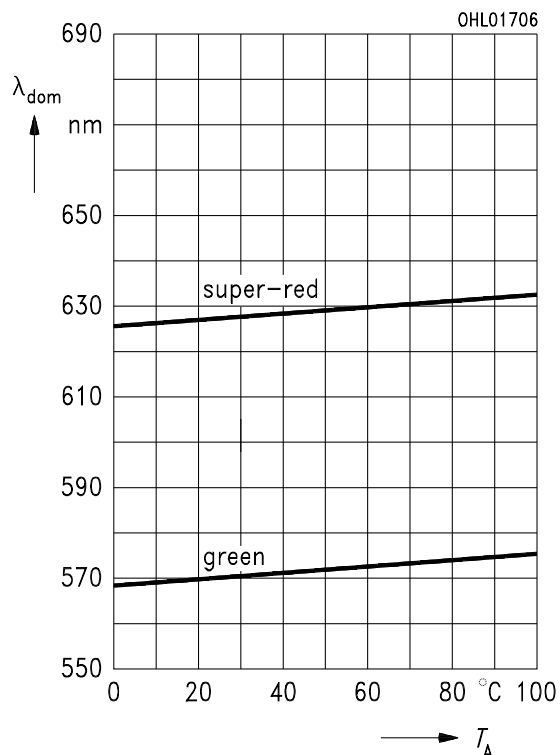

**Durchlaßspannung  $V_F = f(T_A)$**   
**Forward voltage**

$I_F = 10 \text{ mA}$

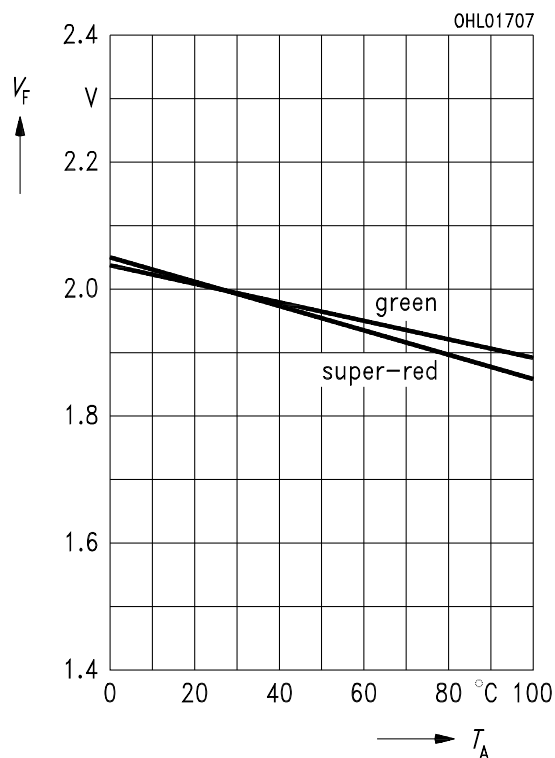

**Relative Lichtstärke  $I_V/I_{V(25^{\circ}\text{C})} = f(T_A)$**   
**Relative luminous intensity**

$I_F = 10 \text{ mA}$

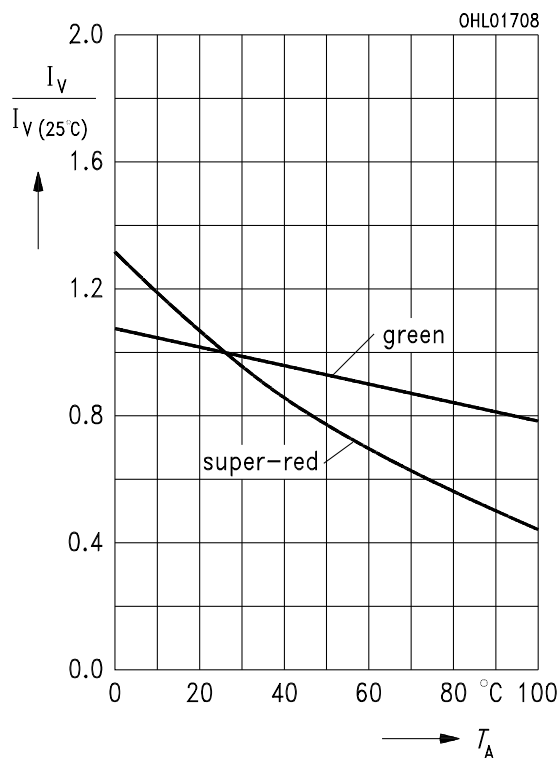

**Maßzeichnung** (Maße in mm, wenn nicht anders angegeben)  
**Package Outlines** (Dimensions in mm, unless otherwise specified)

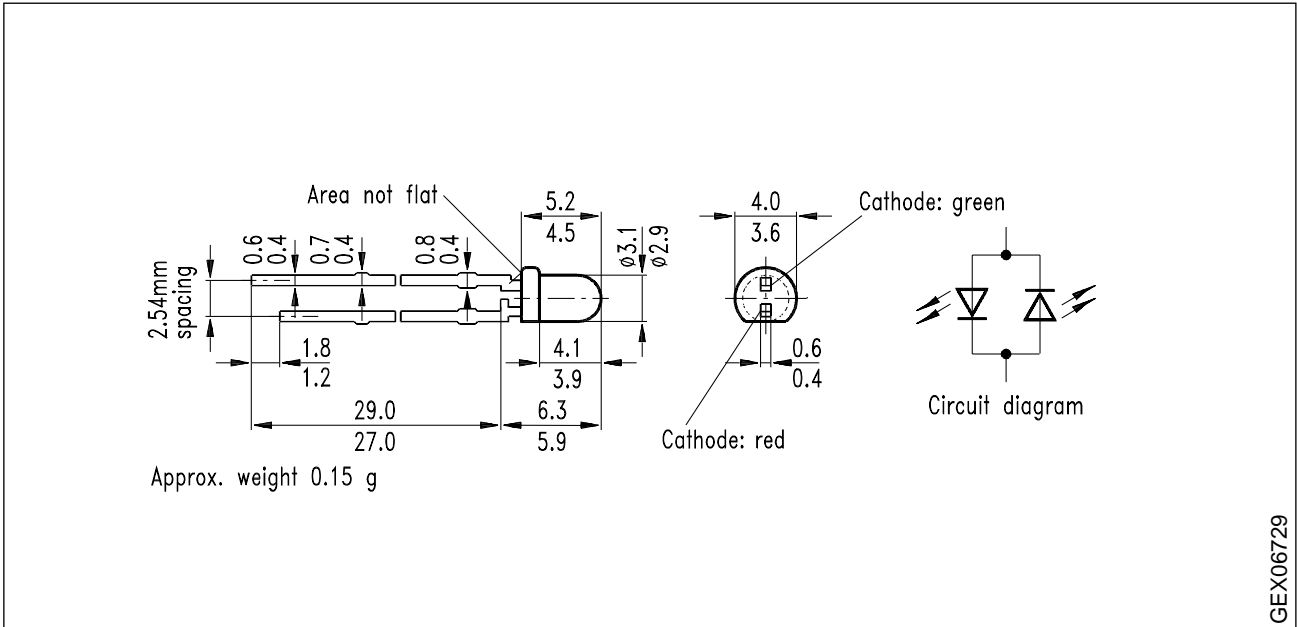

GEX06729

**Kathodenkennzeichnung:**

- grün: längerer Lötspieß
- rot: kürzerer Lötspieß

**Cathode mark:**

- green: long solder lead
- red: short solder lead