

Linear Systems replaces discontinued Siliconix J111

This n-channel JFET is optimised for low noise high performance switching. The part is particularly suitable for use in low noise audio amplifiers. The SOT-23 package is well suited for cost sensitive applications and mass production.

(See Packaging Information).

LSJ111 Benefits:

- Short Sample & Hold Aperture Time
- Low insertion loss
- Low Noise

LSJ111 Applications:

- Analog Switches
- Commutators
- Choppers

FEATURES

DIRECT REPLACEMENT FOR SILICONIX J111

LOW GATE LEAKAGE CURRENT 5pA

FAST SWITCHING $t_{(on)} \leq 4ns$

ABSOLUTE MAXIMUM RATINGS @ 25°C (unless otherwise noted)

Maximum Temperatures

Storage Temperature -55°C to +150°C

Operating Junction Temperature -55°C to +135°C

Maximum Power Dissipation

Continuous Power Dissipation 350mW

MAXIMUM CURRENT

Gate Current (Note 1) 50mA

MAXIMUM VOLTAGES

Gate to Drain Voltage $V_{GDS} = -35V$

Gate to Source Voltage $V_{GSS} = -35V$

LSJ111 ELECTRICAL CHARACTERISTICS @ 25°C (unless otherwise noted)

SYMBOL	CHARACTERISTIC	MIN	TYP.	MAX	UNITS	CONDITIONS
BV_{GSS}	Gate to Source Breakdown Voltage	-35	--	--	V	$I_G = 1\mu A, V_{DS} = 0V$
$V_{GS(off)}$	Gate to Source Cutoff Voltage	-3	--	-10		$V_{DS} = 5V, I_D = 1\mu A$
$V_{GS(F)}$	Gate to Source Forward Voltage	--	0.7	--		$I_G = 1mA, V_{DS} = 0V$
I_{DSS}	Drain to Source Saturation Current (Note 2)	20	--	--	mA	$V_{DS} = 15V, V_{GS} = 0V$
I_{GSS}	Gate Reverse Current	--	-0.005	-1	nA	$V_{GS} = -15V, V_{DS} = 0V$
I_G	Gate Operating Current	--	-0.5	--	pA	$V_{DG} = 15V, I_D = 10mA$
$I_{D(off)}$	Drain Cutoff Current	--	0.005	1	nA	$V_{DS} = 5V, V_{GS} = -10V$
$r_{DS(on)}$	Drain to Source On Resistance	--	--	30	Ω	$I_G = 1mA, V_{DS} = 0V$

LSJ111 DYNAMIC ELECTRICAL CHARACTERISTICS @ 25°C (unless otherwise noted)

SYMBOL	CHARACTERISTIC	MIN	TYP.	MAX	UNITS	CONDITIONS
g_{fs}	Forward Transconductance	--	6	--	mS	$V_{DS} = 20V, I_D = 1mA, f = 1kHz$
g_{os}	Output Conductance	--	25	--	μS	
$r_{DS(on)}$	Drain to Source On Resistance	--	--	30	Ω	$V_{GS} = 0V, I_D = 0mA, f = 1kHz$
C_{iss}	Input Capacitance	--	7	12	pF	$V_{DS} = 0V, V_{GS} = -10V, f = 1MHz$
C_{rss}	Reverse Transfer Capacitance	--	3	5		
e_n	Equivalent Noise Voltage	--	3	--	nV/√Hz	$V_{DG} = 10V, I_D = 1mA, f = 1kHz$

LSJ111 SWITCHING CHARACTERISTICS @ 25°C (unless otherwise noted)

SYMBOL	CHARACTERISTIC	UNITS	CONDITIONS
$t_{d(on)}$	Turn On Time	2	$V_{DD} = 10V$ $V_{GS(H)} = 0V$ See Switching Circuit
t_r	Turn On Rise Time	2	
$t_{d(off)}$	Turn Off Time	6	
t_f	Turn Off Fall Time	15	

Note 1 - Absolute maximum ratings are limiting values above which LSJ111 serviceability may be impaired. Note 2 - Pulse test: $PW \leq 300 \mu s$, Duty Cycle $\leq 3\%$

LSJ111 SWITCHING CIRCUIT PARAMETERS

$V_{GS(L)}$	-12V
R_L	800 Ω
$I_{D(on)}$	12mA

Available Packages:

LSJ111 in SOT-23
LSJ111 in bare die.

Please contact Micross for full package and die dimensions

SOT-23 (Top View)

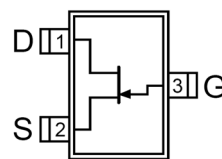

SWITCHING TEST CIRCUIT

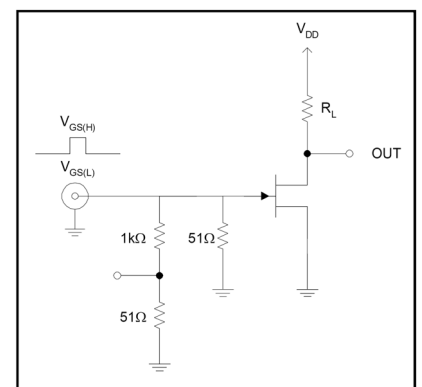

Micross Components Europe