



DATE : 27. Jan. 2012

SAMSUNG TFT-LCD P

MODEL : LSJ400HM05-E

The Information Described in this Specification is Preliminary and can be changed without prior notice

LCD Business

Samsung Electronics Co . , LTD.

Revision History ----- (3)

General Description ----- (4)

General Information ----- (4)

1. Absolute Maximum Ratings ----- (5)

2. Optical Characteristics ----- (6)

3. Electrical Characteristics ----- (9)

 3.1 TFT LCD Module

4. Input Terminal Pin Assignment ----- (11)

 4.1. Input Signal & Power

 4.2 LVDS Interface

 4.3 Input Signals, Basic Display Colors and Gray Scale of Each Color

5. Interface Timing ----- (14)

 5.1 Timing Parameters

 5.2 Timing Diagrams of interface Signal

 5.3 Power ON/OFF Sequence

6. Outline Dimension ----- (17)

7. Packing ----- (18)

 7.1 CARTON(Internal Package)

 7.2 Packing Specification

8. Marking & Others ----- (20)

9. General Precaution ----- (21)

 9.1 Handling

 9.2 Storage

 9.3 Operation

 9.4 Operation Condition Guide

 9.5 Others

Revision History

Date	Rev. No	Page	Summary
27.Jan.2012	000	all	First issued

Description

LSJ400HM05 is a color active matrix liquid crystal display (LCD) that uses amorphous silicon TFT(Thin Film Transistor) as switching components. This model is composed of a TFT LCD panel, a driver circuit. The resolution of a 40" is 1920 x 1080 and this model can display up to 16.7 million colors with wide viewing angle of 89° or higher in all directions. This panel is intended to support applications to provide a excellent performance for Flat Panel Display such as Home-alone Multimedia TFT-LCD TV and High Definition TV.

Features

- High contrast & aperture ratio with wide color gamut
- SPVA (Super Patterned Vertical Align) mode
- Wide viewing angle ($\pm 178^\circ$)
- High speed response
- FHD resolution (16:9)
- 2Ch LVDS (Low Voltage Differential Signaling) interface

General Information

Items	Specification	Unit	Note
Panel Size	902.6(H) x 517.1(V)	mm	$\pm 1.0\text{mm}$
	1.76(D)		Max
Weight	1.9(Max)	kg	
Pixel Pitch	0.46125(H) X 0.15375(V)	mm	
Active Display Area	885.6(H) X 498.15(V)	mm	
Surface Treatment	Haze 2%, Hard-coating (2H)		
Display Colors	16.7M (8Bits Dithering)	colors	
Number of Pixels	1920 x 1080	pixel	
Pixel Arrangement	RGB vertical stripe		
Display Mode	Normally Black		

1. Absolute Maximum Ratings

If the condition exceeds maximum ratings, it can cause malfunction or unrecoverable damage to the device.

(V_{SS} = 0 V)

Item	Symbol	Min.	Max.	Unit	Note
Power Supply Voltage	V _{DD}	10.8	13.2	V	(1)
Storage temperature	T _{STG}	5	40	°C	(2)
Glass surface temperature (Operation)	Center T _{OPR}	0	50	°C	(2)

Note (1) Ta= 25 ± 2 °C

(2) Temperature and relative humidity range are shown in the figure below.

- a. 90 % RH Max. (Ta ≤ 39 °C)
- b. Relative Humidity is 90% or less. (Ta > 39 °C)
- c. No condensation

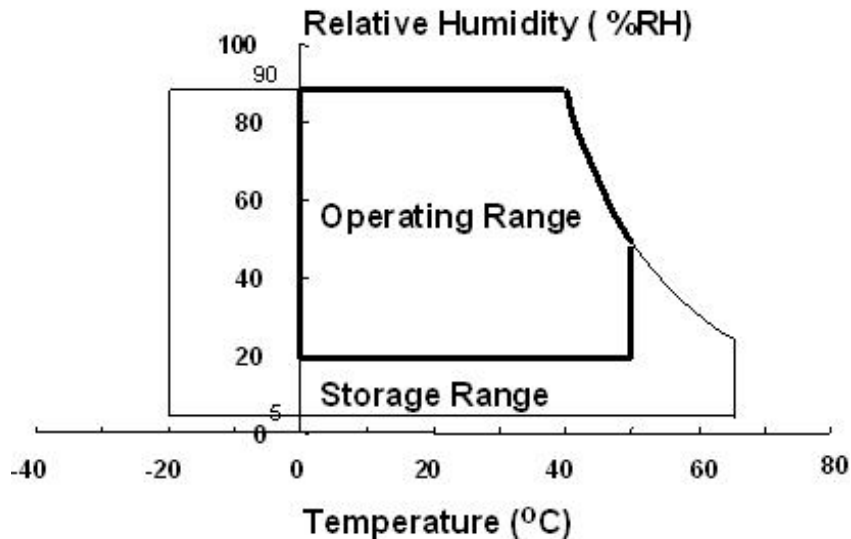

2. Optical Characteristics

The optical characteristics should be measured in a dark room or equivalent.

Measuring equipment : TOPCON RD-80S, ELDIM EZ-Contrast

(Ta = 25 ± 2°C, VDD=12V)

Item	Symbol	Condition	Min.	Typ.	Max.	Unit	Note	
Contrast Ratio (Center of screen)		C/R	4,000	5,000	-		(1) D65	
Response Time	G-to-G	Tg	-	10	16	msec	(2) RD-80S	
Color Chromaticity (CIE 1931)	Red	Rx	Normal $\theta_{L,R}=0$ $\theta_{U,D}=0$ Viewing Angle	0.640	TYP. -0.03	TYP. +0.03	(3),(4)	
		Ry		0.330				
	Green	Gx		0.300				
		Gy		0.600				
	Blue	Bx		0.150				
		By		0.060				
	White	Wx		0.280				
		Wy		0.290				
sRGB Concordance		-	-	98.5	-	%	(3)	
Color Temperature		-	-	10,000	-	K		
Viewing Angle	Hor.	θ_L	C/R≥10	75	89	-	Degree	(4) EZ- Contrast
		θ_R		75	89	-		
	Ver.	θ_U		75	89	-		
		θ_D		75	89	-		

Notice

(a) Test Equipment Setup

The measurement should be executed in a stable, windless and dark room between 40min and 60min after operating the Panel at the given temperature for stabilization of the standard light(SEC use standard illuminant D65 Media).

This should be measured in the center of screen. Environment condition : Ta = 25 ± 2 °C

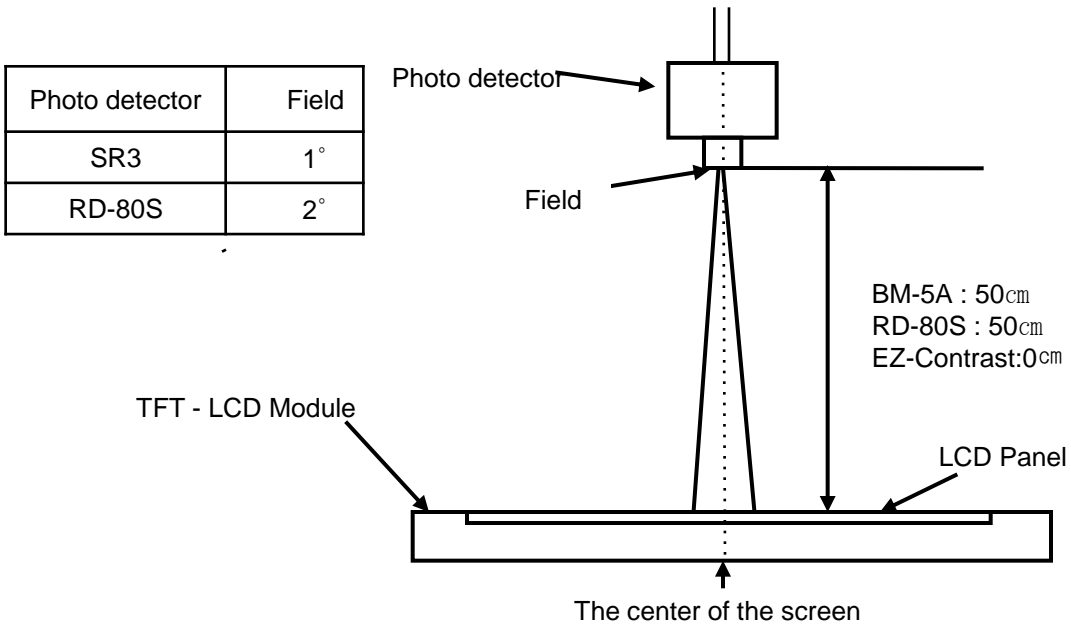

- Definition of test point

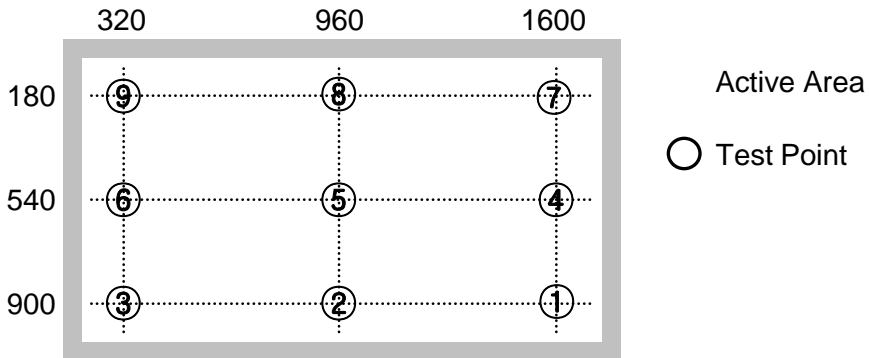

Note (1) Definition of Contrast Ratio (C/R)

: Ratio of gray max (Gmax) & gray min (Gmin) at the center point ⑤ of the panel

$$C/R = \frac{G_{max}}{G_{min}}$$

Gmax : Luminance with all pixels white

Gmin : Luminance with all pixels black

Note (2) Definition of Response time : Sum of T_r , T_f

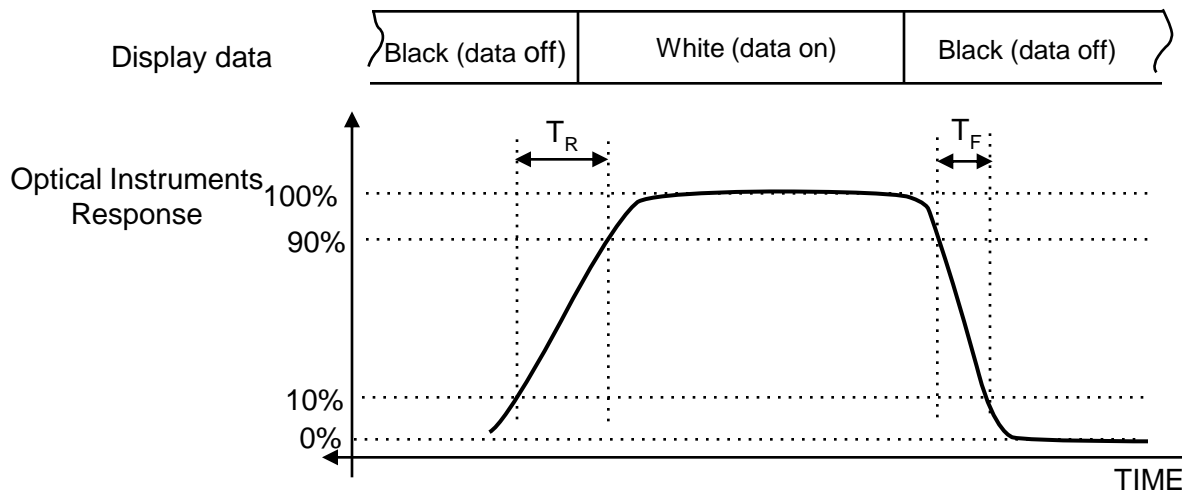

※ G-to-G : Average response time between Gray to Gray (Scale)

Note (3) Definition of Color Chromaticity (CIE 1931)

Color coordinate of Red, Green, Blue & White at center point ⑤
 The measurement goes in D65 Standard Light Source

Note (4) Definition of Viewing Angle

: Viewing angle range (C/R ≥ 10)
 The measurement goes in D65 Standard Light Source

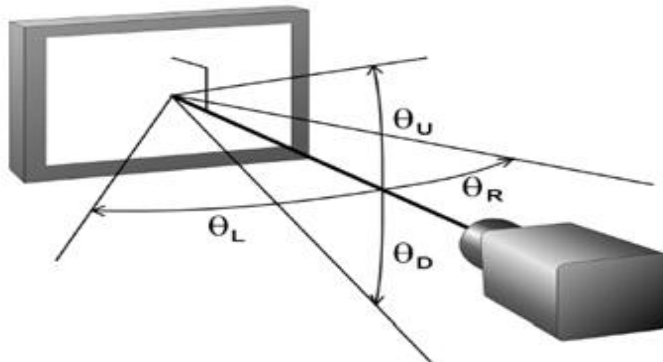

3. Electrical Characteristics

3.1 TFT LCD Module

The connector for display data & timing signal should be connected.

$T_a = 25^\circ\text{C} \pm 2^\circ\text{C}$

Item	Symbol	Min.	Typ.	Max.	Unit	Note	
Voltage of Power Supply	VDD	10.8	12.0	13.2	V	(1)	
Current of Power Supply	(a) Black	IDD	-	500	700	mA	(2),(3)
	(b) White		-	500	700	mA	
	(c) N-pattern		-	800	1000	mA	
Vsync Frequency	Fv	45	60	65	Hz		
Hsync Frequency	fH	48	67.5	75	kHz		
Main Frequency	Fdclk	130	148.5	160	MHz		
Rush Current	IRUSH	-	-	4	A	(4)	

Note (1) The ripple voltage should be controlled under 10% of V_{DD} .

(2) $f_v = 60\text{ Hz}$, $f_{DCLK} = 148.5\text{ MHz}$, $V_{DD} = 12.0\text{V}$, DC Current.

(3) Power dissipation check pattern (LCD Module only)

a) Black Pattern b) White Pattern c) N-pattern

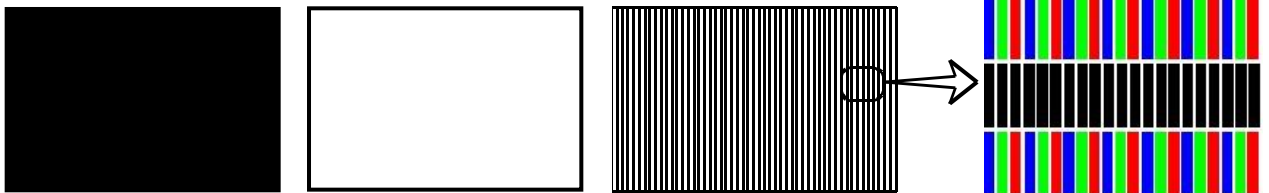

(4) Measurement Conditions

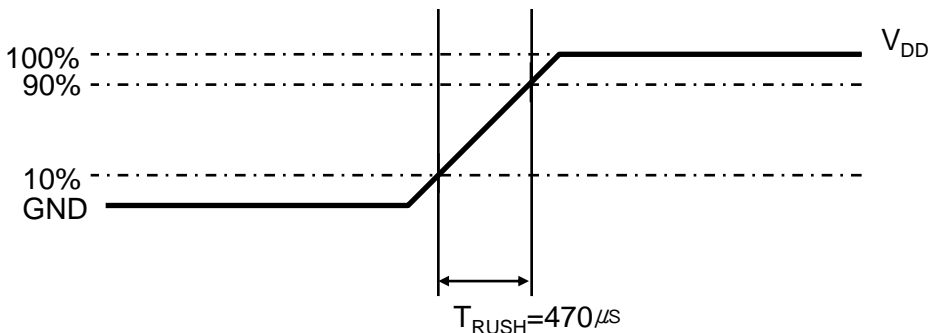

Rush Current I_{RUSH} can be measured when T_{RUSH} is $470\mu\text{s}$.

4. Input Terminal Pin Assignment

4.1. Input Signal & Power

Pin	Description		Pin	Description	
1	Vdd (12V)		26	Even LVDS Signal	Rx3[0]P
2	Vdd (12V)		27		Rx3[1]N
3	Vdd (12V)		28		Rx3[1]P
4	Vdd (12V)		29		Rx3[2]N
5	Vdd (12V)		30		Rx3[2]P
6	N.C		31		GND
7	GND		32		Rx3CLK-
8	GND		33		Rx3CLK+
9	GND		34		GND
10	Even LVDS Signal	Rx1[0]N	35		Rx3[3]N
11		Rx1[0]P	36	Rx3[3]P	
12		Rx1[1]N	37	Rx3[4]N	NOTE3
13		Rx1[1]P	38	Rx3[4]P	NOTE3
14		Rx1[2]N	39	GND	
15		Rx1[2]P	40	No connection	
16		GND	41	No connection	
17		Rx1CLK-	42	No connection	
18		Rx1CLK+	43	No connection	
19		GND	44	No connection	
20	Rx1[3]N	45	No connection		
21	Rx1[3]P	46	No connection		
22	Rx1[4]N	NOTE3	47	No connection	
23	Rx1[4]P	NOTE3	48	No connection	
24	GND		49	No connection	
25	Even LVDS	Rx3[0]N	50	No connection	
			51	No connection	

Note 1) NO CONNECTED : THIS PINS ARE ONLY USED FOR SEC INTERNAL OPERATIONS.

Note 2) LVDS OPTION : HIGH (3.3 V) → NORMAL, LOW (GND) & Default → JEIDA

Note 3) IF LVDS 8Bit Input

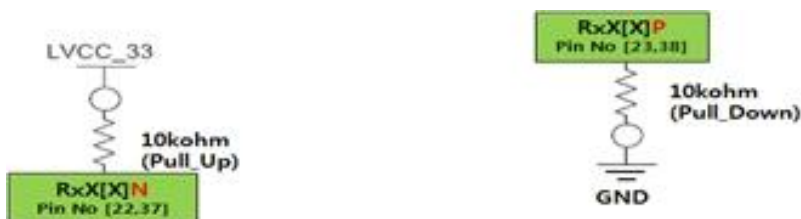

Aging CNT Pin Map								
NO	1	2	3	4	5	6	7	8
NAME	12V	12V	Gnd	A_EN (ActiveLow InputCNT)	WP	SDA	SCL	Gnd

Note(1) Pin number starts from Bottom side

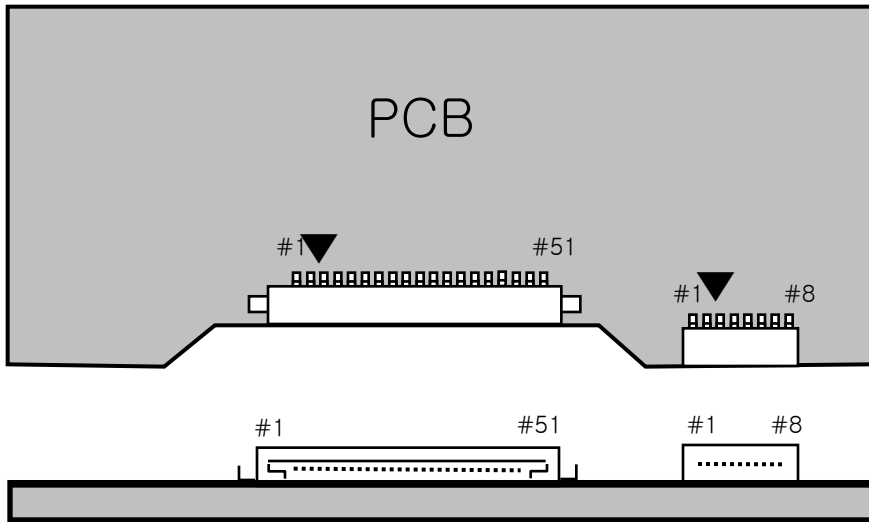

Fig. Connector diagram

- a. Power GND pins should be connected to the LCD's metal chassis.
- b. All power input pins should be connected together.
- c. All NC pin should be separated from other signal or power.

4.2 LVDS Interface

- LVDS Receiver : Tcon (merged) - Data Format (JEIDA)

Samsung Secret

	LVDS pin	JEIDA -DATA
TxOUT/RxIN0	TxIN/RxOUT0	R2
	TxIN/RxOUT1	R3
	TxIN/RxOUT2	R4
	TxIN/RxOUT3	R5
	TxIN/RxOUT4	R6
	TxIN/RxOUT6	R7
	TxIN/RxOUT7	G2
TxOUT/RxIN1	TxIN/RxOUT8	G3
	TxIN/RxOUT9	G4
	TxIN/RxOUT12	G5
	TxIN/RxOUT13	G6
	TxIN/RxOUT14	G7
	TxIN/RxOUT15	B2
	TxIN/RxOUT18	B3
TxOUT/RxIN2	TxIN/RxOUT19	B4
	TxIN/RxOUT20	B5
	TxIN/RxOUT21	B6
	TxIN/RxOUT22	B7
	TxIN/RxOUT24	HSYNC
	TxIN/RxOUT25	VSYNC
	TxIN/RxOUT26	DEN
TxOUT/RxIN3	TxIN/RxOUT27	R0
	TxIN/RxOUT5	R1
	TxIN/RxOUT10	G0
	TxIN/RxOUT11	G1
	TxIN/RxOUT16	B0
	TxIN/RxOUT17	B1
	TxIN/RxOUT23	RESERVED

4.3 Input Signals, Basic Display Colors and Gray Scale of Each Color

COLOR	DISPLAY (8bit)	DATA SIGNAL																												GRAY SCALE LEVEL	
		RED										GREEN										BLUE									
		R0	R1	R2	R3	R4	R5	R6	R7	R8	R9	G0	G1	G2	G3	G4	G5	G6	G7	G8	G9	B0	B1	B2	B3	B4	B5	B6	B7		B8
BASIC COLOR	BLACK	0	0	0	0	0	0	0	0	0	0	0	0	0	0	0	0	0	0	0	0	0	0	0	0	0	0	0	0	0	-
	BLUE	0	0	0	0	0	0	0	0	0	0	0	0	0	0	0	0	0	0	0	0	1	1	1	1	1	1	1	1	1	-
	GREEN	0	0	0	0	0	0	0	0	0	0	1	1	1	1	1	1	1	1	1	1	1	0	0	0	0	0	0	0	0	-
	CYAN	0	0	0	0	0	0	0	0	0	0	1	1	1	1	1	1	1	1	1	1	1	1	1	1	1	1	1	1	1	-
	RED	1	1	1	1	1	1	1	1	1	1	0	0	0	0	0	0	0	0	0	0	0	0	0	0	0	0	0	0	0	-
	MAGENTA	1	1	1	1	1	1	1	1	1	1	0	0	0	0	0	0	0	0	0	0	1	1	1	1	1	1	1	1	1	-
	YELLOW	1	1	1	1	1	1	1	1	1	1	1	1	1	1	1	1	1	1	1	1	0	0	0	0	0	0	0	0	0	-
	WHITE	1	1	1	1	1	1	1	1	1	1	1	1	1	1	1	1	1	1	1	1	1	1	1	1	1	1	1	1	1	-
GRAY SCALE OF RED	BLACK	0	0	0	0	0	0	0	0	0	0	0	0	0	0	0	0	0	0	0	0	0	0	0	0	0	0	0	0	R0	
	DARK ↑	1	0	0	0	0	0	0	0	0	0	0	0	0	0	0	0	0	0	0	0	0	0	0	0	0	0	0	0	R1	
		0	1	0	0	0	0	0	0	0	0	0	0	0	0	0	0	0	0	0	0	0	0	0	0	0	0	0	0	R2	
		:	:	:	:	:	:	:	:	:	:	:	:	:	:	:	:	:	:	:	:	:	:	:	:	:	:	:	:	R3~	
		:	:	:	:	:	:	:	:	:	:	:	:	:	:	:	:	:	:	:	:	:	:	:	:	:	:	:	:	R1020	
	↓ LIGHT	1	0	1	1	1	1	1	1	1	1	0	0	0	0	0	0	0	0	0	0	0	0	0	0	0	0	0	0	R1021	
		0	1	1	1	1	1	1	1	1	1	0	0	0	0	0	0	0	0	0	0	0	0	0	0	0	0	0	0	R1022	
	RED	1	1	1	1	1	1	1	1	1	1	0	0	0	0	0	0	0	0	0	0	0	0	0	0	0	0	0	0	R1023	
GRAY SCALE OF GREEN	BLACK	0	0	0	0	0	0	0	0	0	0	0	0	0	0	0	0	0	0	0	0	0	0	0	0	0	0	0	0	G0	
	DARK ↑	0	0	0	0	0	0	0	0	0	0	1	0	0	0	0	0	0	0	0	0	0	0	0	0	0	0	0	0	G1	
		0	0	0	0	0	0	0	0	0	0	0	1	0	0	0	0	0	0	0	0	0	0	0	0	0	0	0	0	G2	
		:	:	:	:	:	:	:	:	:	:	:	:	:	:	:	:	:	:	:	:	:	:	:	:	:	:	:	:	G3~	
		:	:	:	:	:	:	:	:	:	:	:	:	:	:	:	:	:	:	:	:	:	:	:	:	:	:	:	:	G1020	
	↓ LIGHT	0	0	0	0	0	0	0	0	0	0	1	0	1	1	1	1	1	1	1	1	1	0	0	0	0	0	0	0	G1021	
		0	0	0	0	0	0	0	0	0	0	0	1	1	1	1	1	1	1	1	1	1	0	0	0	0	0	0	0	G1022	
	GREEN	0	0	0	0	0	0	0	0	0	0	1	1	1	1	1	1	1	1	1	1	1	0	0	0	0	0	0	0	G1023	
GRAY SCALE OF BLUE	BLACK	0	0	0	0	0	0	0	0	0	0	0	0	0	0	0	0	0	0	0	0	0	0	0	0	0	0	0	0	B0	
	DARK ↑	0	0	0	0	0	0	0	0	0	0	0	0	0	0	0	0	0	0	0	0	1	0	0	0	0	0	0	0	B1	
		0	0	0	0	0	0	0	0	0	0	0	0	0	0	0	0	0	0	0	0	0	1	0	0	0	0	0	0	B2	
		:	:	:	:	:	:	:	:	:	:	:	:	:	:	:	:	:	:	:	:	:	:	:	:	:	:	:	:	B3~	
		:	:	:	:	:	:	:	:	:	:	:	:	:	:	:	:	:	:	:	:	:	:	:	:	:	:	:	:	B1020	
	↓ LIGHT	0	0	0	0	0	0	0	0	0	0	0	0	0	0	0	0	0	0	0	0	0	1	0	1	1	1	1	1	B1021	
		0	0	0	0	0	0	0	0	0	0	0	0	0	0	0	0	0	0	0	0	0	1	1	1	1	1	1	1	B1022	
	BLUE	0	0	0	0	0	0	0	0	0	0	0	0	0	0	0	0	0	0	0	0	1	1	1	1	1	1	1	1	B1023	

Note) Definition of Gray :

Rn : Red Gray, Gn : Green Gray, Bn : Blue Gray (n = Gray level)

Input Signal : 0 = Low level voltage, 1 = High level voltage

5. Interface Timing

5.1 Timing Parameters (Timing-Controller)

SIGNAL	ITEM	SYMBOL	MIN.	TYP.	MAX.	Unit	NOTE
Clock	Frequency	$1/T_C$	130	148.5	160	MHz	
Frame Frequency	Cycle	T_V	45	60	65	Hz	
		T_H	48	67.5	75	KHz	
Vertical Display Term	Active Display Period	T_{VD}	-	1080	-	Lines	
	Vertical Total	T_{VB}	1092	1125	1158	Lines	
Horizontal Display Term	Active Display Period	T_{HD}	-	1920	-	Clocks	
	Horizontal Total	T_H	2090	2200	2350	Clocks	

Note) This product is DE only mode. The input of Hsync & Vsync signal does not have an effect on normal operation.

- (1) Test Point : TTL control signal and CLK at LVDS Tx input terminal in system
- (2) Internal $V_{DD} = 3.3V$
- (3) Spread spectrum
 - Modulation rate (max) : $\pm 1.5 \%$
 - Modulation Frequency : 30 ~ 300KHz

5.2 Timing diagrams of interface signal (DE only mode)

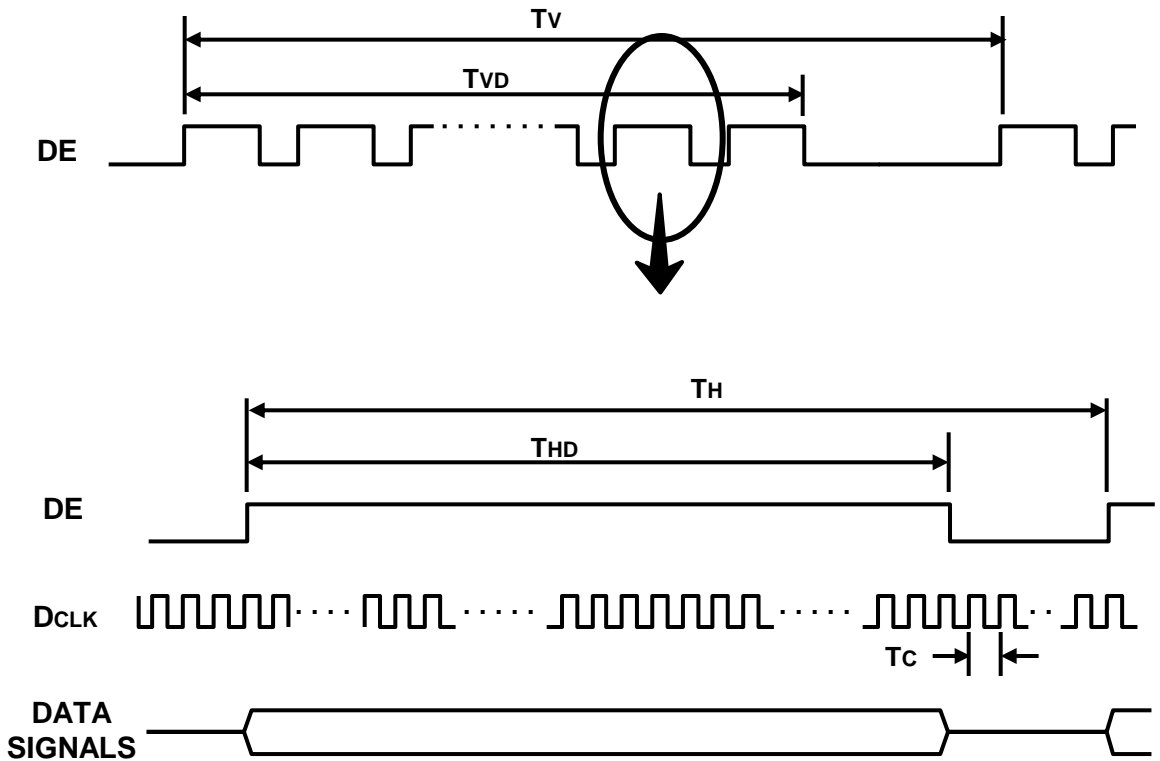

5.3 Power ON/OFF Sequence

To prevent a latch-up or DC operation of the LCD Module, the power on/off sequence should be as the diagram below.

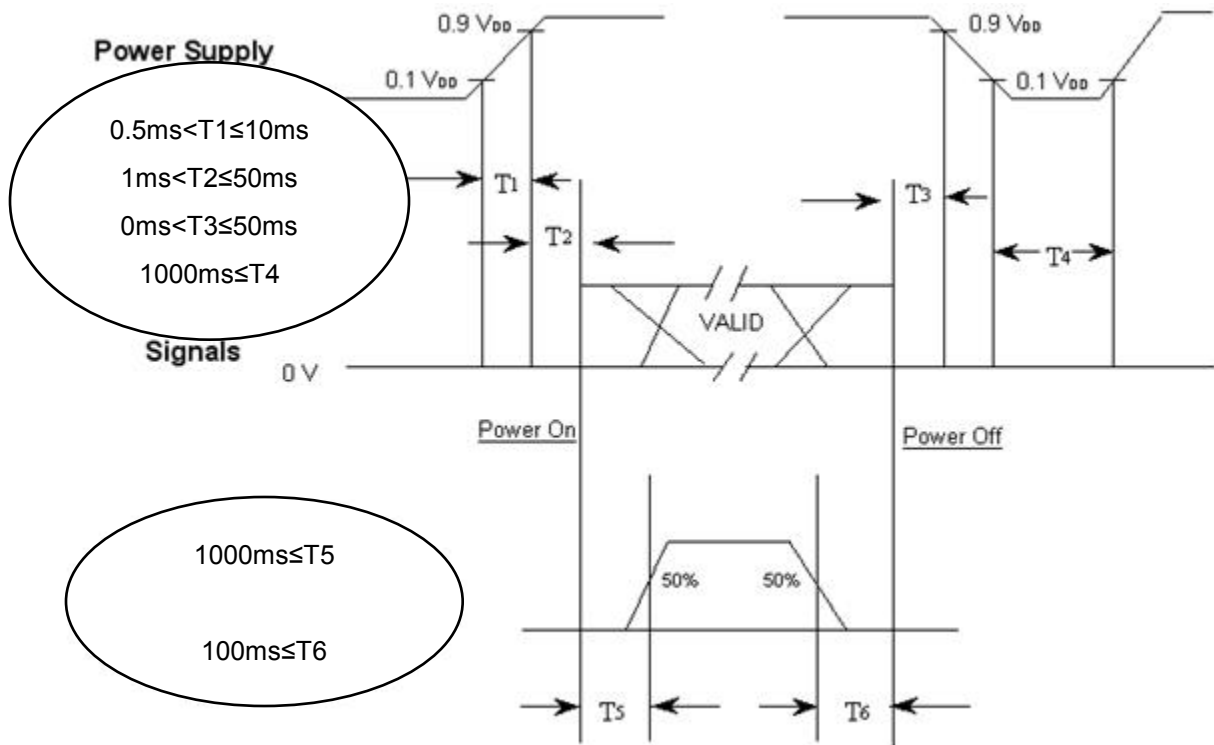

- T1 : V_{DD} rising time from 10% to 90%
- T2 : The time from V_{DD} to valid data at power ON.
- T3 : The time from valid data off to V_{DD} off at power Off.
- T4 : V_{DD} off time for Windows restart
- T5 : The time from valid data to B/L enable at power ON.
- T6 : The time from valid data off to B/L disable at power Off.

- The supply voltage of the external system for the Module input should be the same as the definition of V_{DD}.
- Apply the lamp voltage within the LCD operation range. When the back light turns on before the LCD operation or the LCD turns off before the back light turns off, the display may momentarily show abnormal screen.
- In case of V_{DD} = off level, please keep the level of input signals low or keep a high impedance.
- T4 should be measured after the Module has been fully discharged between power off and on period.
- Interface signal should not be kept at high impedance when the power is on.

NO	PART NAME	CODE NO	SPECIFICATION	QTY	SPEC NO	REMARK
1	OUTLINE DIMENSION	-	FHD, 60Hz, MB4	1		

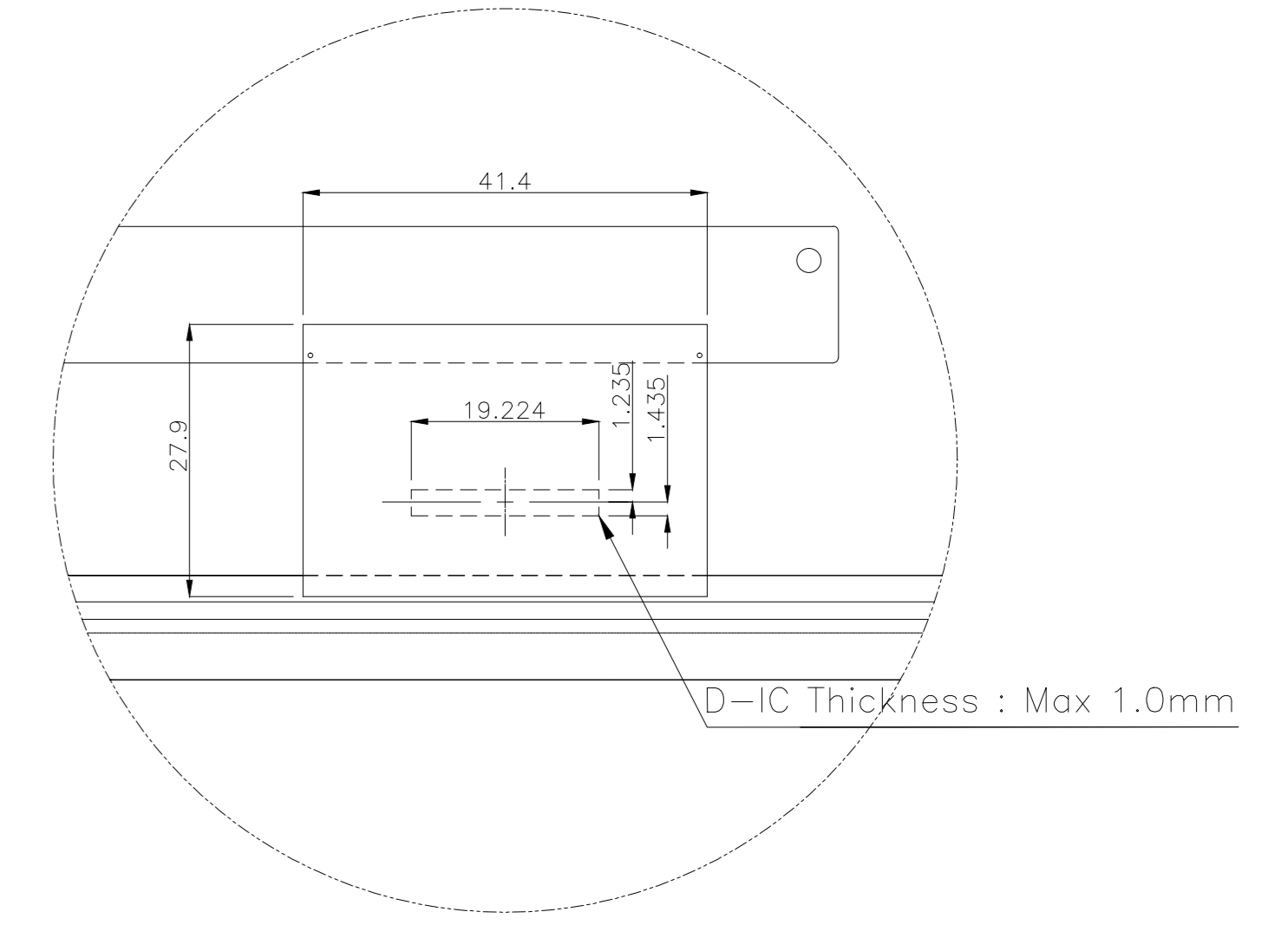
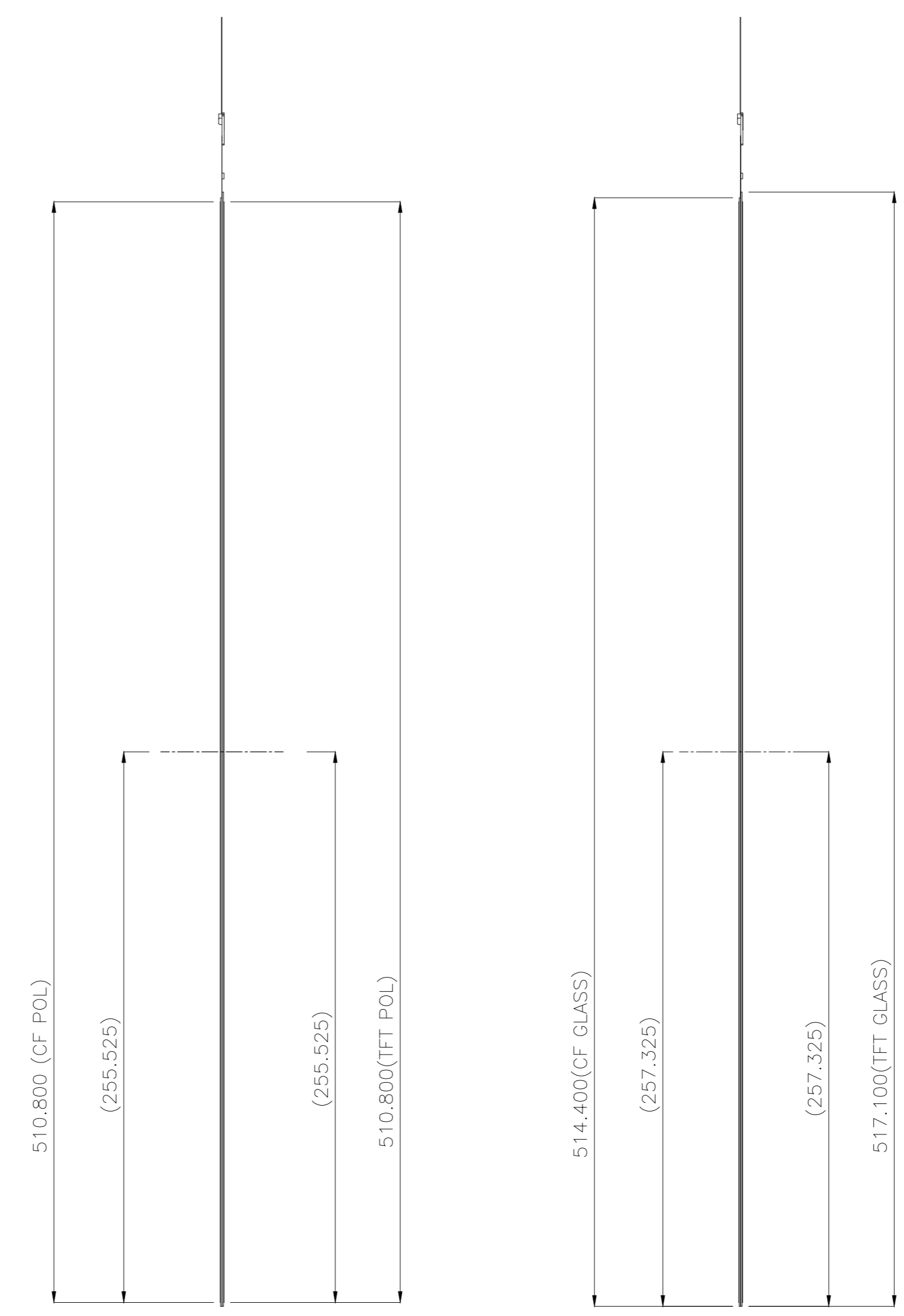
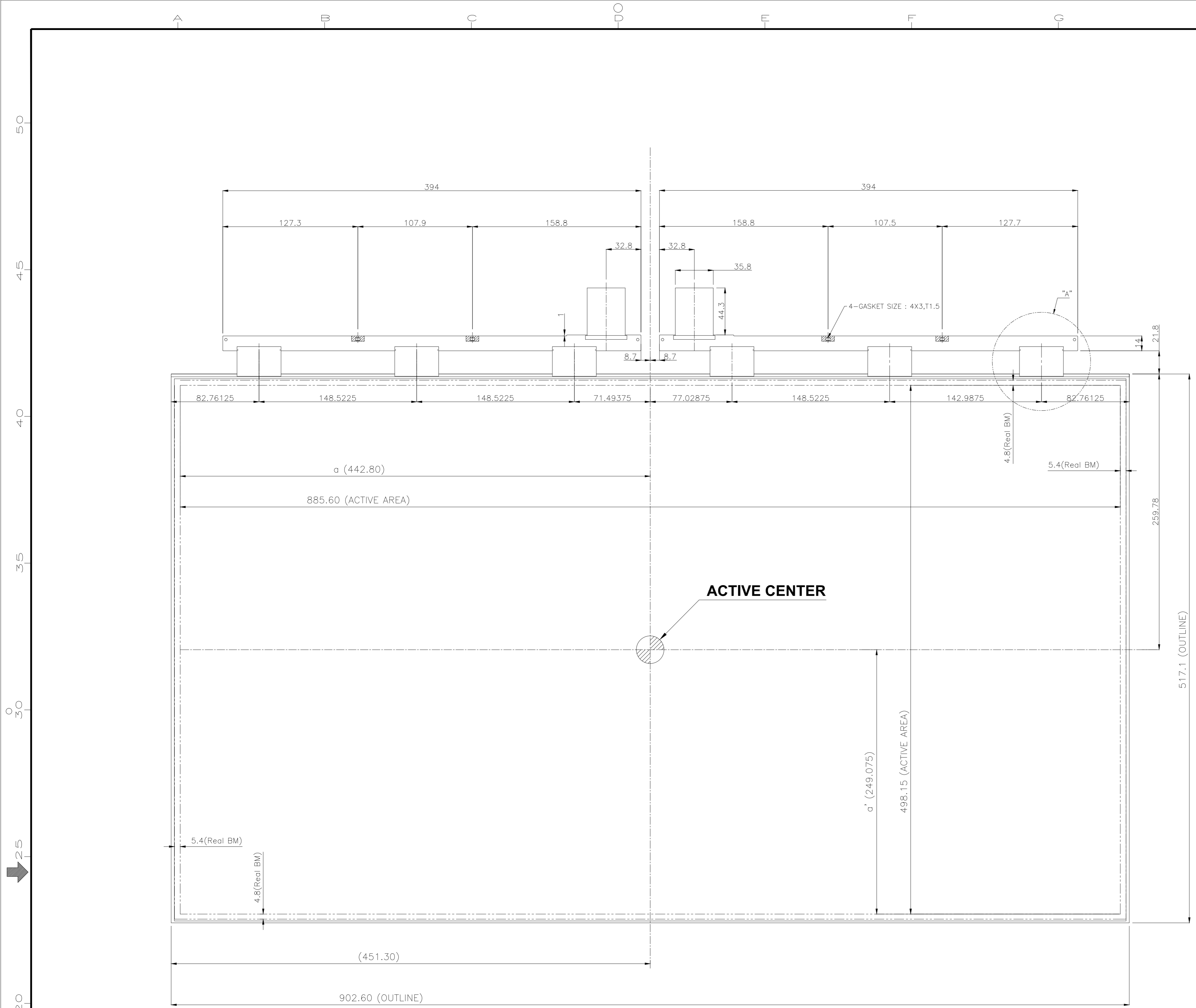

DETAIL "A" (3 : 1)

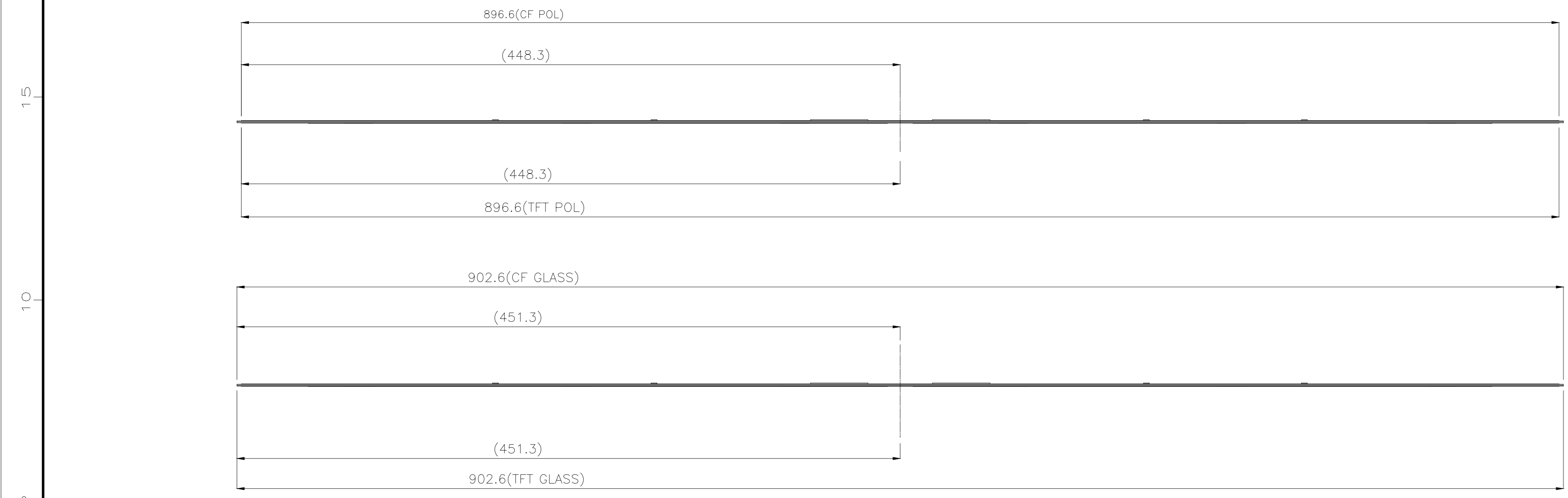

- * NOTE**
- PANEL : TFT-LCD**
2. REFER TO "PRODUCT INFORMATION" OR "PRODUCT SPECIFICATION" DOCUMENTS
- TOLERANCE
- FFC CABLE INFORMATION
- CONNECTOR INFORMATION
- HEIGHT OF CIRCUIT COMPONENTS
 - PANEL THICKNESS**
- CF POL : T0.2
- CF GLASS : T0.7
- TFT GLASS : T0.7
- TFT POL : T0.2
 - BM 관리공차 SPEC**
- REAL BM 간격 관리 공차 : $\pm 0.1\text{mm}$
- 상판 Active Center 기준 BM까지 거리 상/하/좌/우 관리 공차 : $\pm 0.1\text{mm}$ (a, a')

GENERAL TOLERANCE				REV	DATE	DESCRIPTION OF REVISION				REASON		CHK'D BY
STEP	LEVEL 1	LEVEL 2	LEVEL 3	UNIT	mm	DRA'N BY	DES'D BY	CHK'D BY	APP'D BY	MODEL NAME	LSJ400HM05-E	
0 < X <= 4	± 0.05	± 0.1	± 0.2	SCALE	1:1					PART/SHEET NAME	OUTLINE DIMENSION	SHEET 1/1
4 < X <= 16	± 0.08	± 0.15	± 0.3	TOLERANCE		YX.HONG			11.11.09	SPEC. NO		VER. 001
16 < X <= 64	± 0.12	± 0.25	± 0.5	SAMSUNG ELECTRONICS								
64 < X <= 256	± 0.25	± 0.4	± 0.8									

7. PACKING

7.1 CARTON (Internal Package)

- (1) Packing Form Corrugated fiberboard box and corrugated cardboard as shock absorber
- (2) Packing Method

Packing- Upper Box

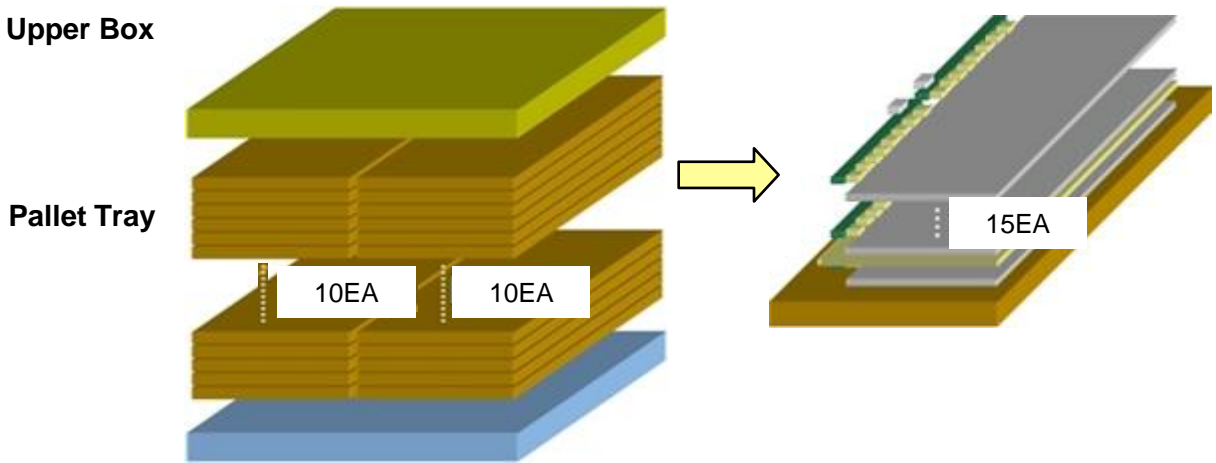

Pallet-Plastic

7.2 Packing Specification

ITEM	Specification	Remark
LCD Packing	300ea / Box	1. 1.90 Kg / LCD (15[ea]/Tray, 300[ea]/Pallet) 2. 0.05 Kg / Middle sheet (18[ea]/Tray, 360[ea]/Pallet) 3. 1.60 Kg / Panel tray (20ea/Pallet) 4. 1.00 Kg / Packing Box (1ea)
Pallet-Wood	1Box / Pallet	1. Pallet weight = 27 kg 2. 27 Kg / Pallet
Pallet size	H x V x height	1,485mm(H) x 1,150mm(V) x 1,192mm(height)
Pallet weight	652.0 kg	Pallet(27kg) + Panel tray(32kg) + Panel(570kg) + Middle sheet(18Kg) + Packing Box (5kg)

8. MARKING & OTHERS

A nameplate bearing followed by is affixed to a shipped product at the specified location on each product.

(1) Cell Label



Lot number : X X X X XXX XX X

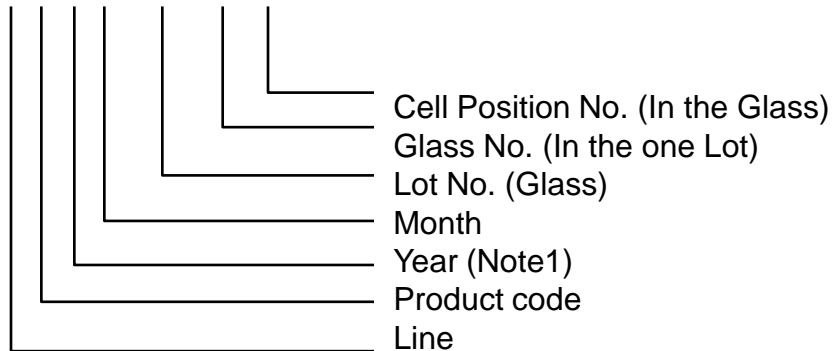

(2) Box Label



BOX Serial : X X X X X X XXXX XX XX

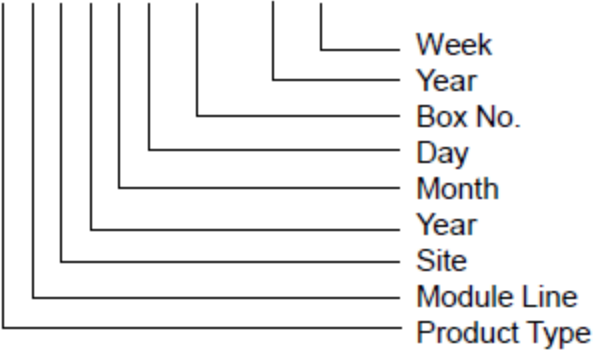

9. General Precautions

9.1 Handling

- (a) When the Module is assembled, it should be attached to the system firmly using all mounting holes. Be careful not to twist and bend the Module.
- (b) Refrain from strong mechanical shock and / or any force to the Module. In addition to damage, this may cause improper operation or damage to the Module and CCFL back light.
- (c) Note that polarizers are very fragile and could be damage easily. Do not press or scratch the surface harder than a HB pencil lead.
- (d) Wipe off water droplets or oil immediately. If you leave the droplets for a long time, staining or discoloration may occur.
- (e) If the surface of the polarizer is dirty, clean it using absorbent cotton or soft cloth.
- (f) Desirable cleaners are water, IPA(Isopropyl Alcohol) or Hexane. Do not use Ketone type materials(ex. Acetone), Ethyl alcohol, Toluene, Ethyl acid or Methyl chloride. It might permanent damage to the polarizer due to chemical reaction.
- (g) If the liquid crystal material leaks from the panel, it should be kept away from the eyes or mouth . In case of contact with hands, legs or clothes, it must be washed away with soap thoroughly.
- (h) Protect the module from Electrostatic discharge. Otherwise the ASIC IC or Semiconductor would be damaged.
- (i) Use finger-stalls with soft gloves in order to keep display clean during the incoming inspection and assembly process.

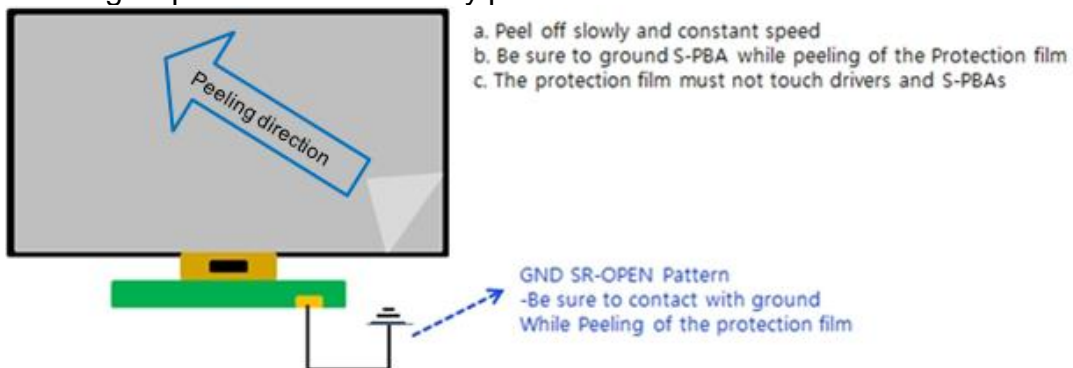

- (k) Protection film for polarizer on the Module should be slowly peeled off just before use so that the electrostatic charge can be minimized. Must put on antistatic glove while handle a module
- (l) Pins of I/F connector should not be touched directly with bare hands.

	Item	Management standard value and performance standard
1	Anti-static mat (shelf)	1 to 50 [Mohm]
2	Anti-static mat (floor, desk)	1 to 100 [Mohm]
3	Ionizer	Attenuate from $\pm 1,000V$ to $\pm 100V$ within 2 sec
4	Anti-static wrist band	0.8 to 10 [Mohm]
5	Anti-static wrist band entry and ground resistance	Below 1,000 [ohm]
6	Temperature	0 ~ 35°C
7	Humidity	60 to 70 [%RH]

9.2 Storage

We highly recommend to comply with the criteria in the table below

ITEM	Unit	Min.	Max.				
Storage Temperature	(°C)	5	40				
Storage Humidity	(%rH)	35	75				
Storage life	6 months						
Storage Condition	<ul style="list-style-type: none"> - The storage room should provide good ventilation and temperature control. - Products should not be placed on the floor, but on the Pallet away from a wall. - Prevent products from direct sunlight, moisture nor water; Be cautious of a build up of condensation. - Avoid other hazardous environment while storing goods. 						
	After	1 month	2 month	3 month	4month	5 month	6month
	Baking	No backing		50°C 10% 24Hr	50°C 10% 48Hr		

9.3 Operation

- (a) Do not connect or disconnect the Module in the "Power On" condition.
- (b) Power supply should always be turned on/off by the "Power on/off sequence"
- (c) Module has high frequency circuits. Sufficient suppression to the electromagnetic interference should be done by system manufacturers. Grounding and shielding methods may be important to minimize the interference.
- (d) The cable between the back light connector and its inverter power supply should be connected directly with a minimized length. A longer cable between the back light and the inverter may cause lower luminance of lamp(CCFT) and may require higher startup voltage(Vs).

9.4 Operation Condition Guide

- (a) The LCD product should be operated under normal conditions.
Normal condition is defined as below;
- Temperature : 20 ± 15 °C
 - Humidity : 55 ± 20 %
 - Display pattern : continually changing pattern (Not stationary)
- (b) If the product will be used in extreme conditions such as high temperature, humidity, display patterns or operation time etc., It is strongly recommended to contact SEC for Application engineering advice. Otherwise, its reliability and function may not be guaranteed. Extreme conditions are commonly found at Airports, Transit Stations, Banks, Stock market, and Controlling systems.

10.5 Others

- (a) Ultra-violet ray filter is necessary for outdoor operation.
- (b) Avoid condensation of water. It may result in improper operation or disconnection of electrode.
- (c) Do not exceed the absolute maximum rating value. (supply voltage variation, input voltage variation, variation in part contents and environmental temperature, and so on)
Otherwise the Module may be damaged.
- (d) If the Module keeps displaying the same pattern for a long period of time, the image may be "sticked" to the screen.
To avoid image sticking, it is recommended to use a screen saver.
- (e) This Module has its circuitry PCB's on the rear side and should be handled carefully in order not to be stressed.
- (f) Please contact SEC in advance when you display the same pattern for a long time.