

Mini TOPLED®

LS M670, LO M670, LY M670
LG M670, LP M670

Besondere Merkmale

- Gehäusefarbe: weiß
- als optischer Indikator einsetzbar
- zur Hinterleuchtung, Lichtleiter- und Linseneinkopplung
- für alle SMT-Bestück- und Löttechniken geeignet
- gegurtet (8-mm-Filmgurt)
- Störimpulsfest nach DIN 40839

Features

- color of package: white
- for use as optical indicator
- for backlighting, optical coupling into light pipes and lenses
- suitable for all SMT assembly and soldering methods
- available taped on reel (8 mm tape)
- load dump resistant acc. to DIN 40839

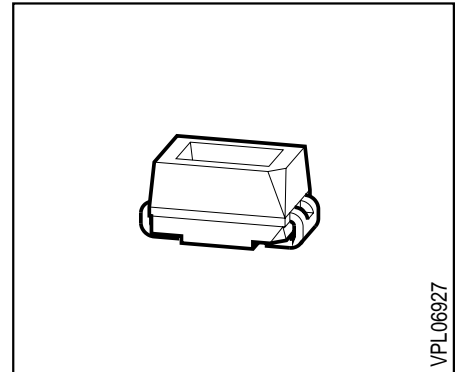

Typ	Emissions- farbe	Farbe der Lichtaustritts- fläche	Lichtstärke	Lichtstrom	Bestellnummer
Type	Color of Emission	Color of the Light Emitting Area	Luminous Intensity $I_F = 10 \text{ mA}$ $I_V \text{ (mcd)}$	Luminous Flux $I_F = 10 \text{ mA}$ $\Phi_V \text{ (mlm)}$	Ordering Code
LS M670-HK	super-red	colorless clear	2.5 ... 12.5	-	Q62703-Q3380
LS M670-J			4.0 ... 8.0	18 (typ.)	Q62703-Q3381
LS M670-K			6.3 ... 12.5	30 (typ.)	Q62703-Q3382
LS M670-JM			4.0 ... 32.0	-	Q62703-Q3383
LO M670-HK	orange	colorless clear	2.5 ... 12.5	-	Q62703-Q3384
LO M670-J			4.0 ... 8.0	18 (typ.)	Q62703-Q3385
LO M670-K			6.3 ... 12.5	30 (typ.)	Q62703-Q3386
LO M670-JM			4.0 ... 32.0	-	Q62703-Q3387
LY M670-HK	yellow	colorless clear	2.5 ... 12.5	-	Q62703-Q3388
LY M670-J			4.0 ... 8.0	18 (typ.)	Q62703-Q3389
LY M670-K			6.3 ... 12.5	30 (typ.)	Q62703-Q3390
LY M670-JM			4.0 ... 32.0	-	Q62703-Q3391
LG M670-HK	green	colorless clear	2.5 ... 12.5	-	Q62703-Q3392
LG M670-J			4.0 ... 8.0	18 (typ.)	Q62703-Q3393
LG M670-K			6.3 ... 12.5	30 (typ.)	Q62703-Q3394
LG M670-JM			4.0 ... 32.0	-	Q62703-Q3395
LP M670-FJ	pure green	colorless clear	1.0 ... 8.0	-	Q62703-Q3396
LP M670-G			1.6 ... 3.2	8 (typ.)	Q62703-Q3397
LP M670-H			2.5 ... 5.0	12 (typ.)	Q62703-Q3398
LP M670-GK			1.6 ... 12.5	-	Q62703-Q3399

Streuung der Lichtstärke in einer Verpackungseinheit $I_{V \max} / I_{V \min} \leq 2.0$.

Luminous intensity ratio in one packaging unit $I_{V \max} / I_{V \min} \leq 2.0$.

Grenzwerte Maximum Ratings

Bezeichnung Parameter	Symbol Symbol	Werte Values	Einheit Unit
Betriebstemperatur Operating temperature range	T_{op}	- 55 ... + 100	°C
Lagertemperatur Storage temperature range	T_{stg}	- 55 ... + 100	°C
Sperrschichttemperatur Junction temperature	T_j	+ 100	°C
Durchlaßstrom Forward current	I_F	30	mA
Stoßstrom Surge current $t \leq 10 \mu s, D = 0.005$	I_{FM}	0.5	A
Sperrspannung Reverse voltage	V_R	5	V
Verlustleistung Power dissipation	P_{tot}	80	mW
Wärmewiderstand Thermal resistance Sperrschicht / Umgebung Junction / air Montage auf PC-board*) (Padgröße $\geq 16 \text{ mm}^2$) mounted on PC board*) (pad size $\geq 16 \text{ mm}^2$)	$R_{th JA}$	480 ¹⁾	K/W

*) PC-board: FR4

1) vorläufig/preliminary

Kennwerte ($T_A = 25\text{ °C}$)

Characteristics

Bezeichnung Parameter	Symbol Symbol	Werte Values					Einheit Unit
		LS	LO	LY	LG	LP	
Wellenlänge des emittierten Lichtes (typ.) Wavelength at peak emission (typ.) $I_F = 10\text{ mA}$	λ_{peak}	635	610	586	565	557	nm
Dominantwellenlänge (typ.) Dominant wavelength (typ.) $I_F = 10\text{ mA}$	λ_{dom}	628	605	590	570	560	nm
Spektrale Bandbreite bei 50 % $I_{\text{rel max}}$ (typ.) Spectral bandwidth at 50 % $I_{\text{rel max}}$ (typ.) $I_F = 10\text{ mA}$	$\Delta\lambda$	45	40	45	25	22	nm
Abstrahlwinkel bei 50 % I_v (Vollwinkel) Viewing angle at 50 % I_v	2ϕ	120	120	120	120	120	Grad deg.
Durchlaßspannung (typ.) Forward voltage (max.) $I_F = 10\text{ mA}$	V_F V_F	2.0 2.6	2.0 2.6	2.0 2.6	2.0 2.6	2.0 2.6	V V
Sperrstrom (typ.) Reverse current (max.) $V_R = 5\text{ V}$	I_R I_R	0.01 10	0.01 10	0.01 10	0.01 10	0.01 10	μA μA
Kapazität (typ.) Capacitance $V_R = 0\text{ V}, f = 1\text{ MHz}$	C_0	12	8	10	15	15	pF
Schaltzeiten: Switching times: I_V from 10 % to 90 % (typ.) I_V from 90 % to 10 % (typ.) $I_F = 100\text{ mA}, t_p = 10\text{ }\mu\text{s}, R_L = 50\text{ }\Omega$	t_r t_f	300 150	300 150	300 150	450 200	450 200	ns ns

Relative spektrale Emission $I_{rel} = f(\lambda)$, $T_A = 25\text{ °C}$, $I_F = 10\text{ mA}$

Relative spectral emission

$V(\lambda)$ = spektrale Augenempfindlichkeit

Standard eye response curve

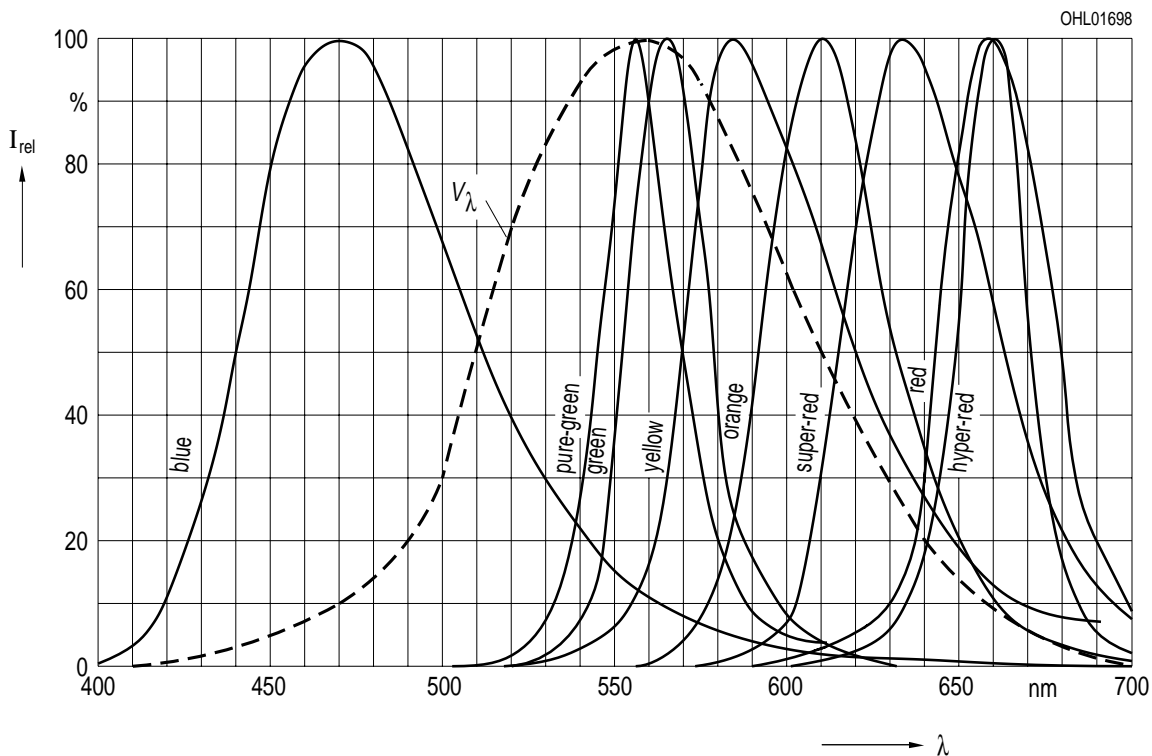

Abstrahlcharakteristik $I_{rel} = f(\varphi)$

Radiation characteristic

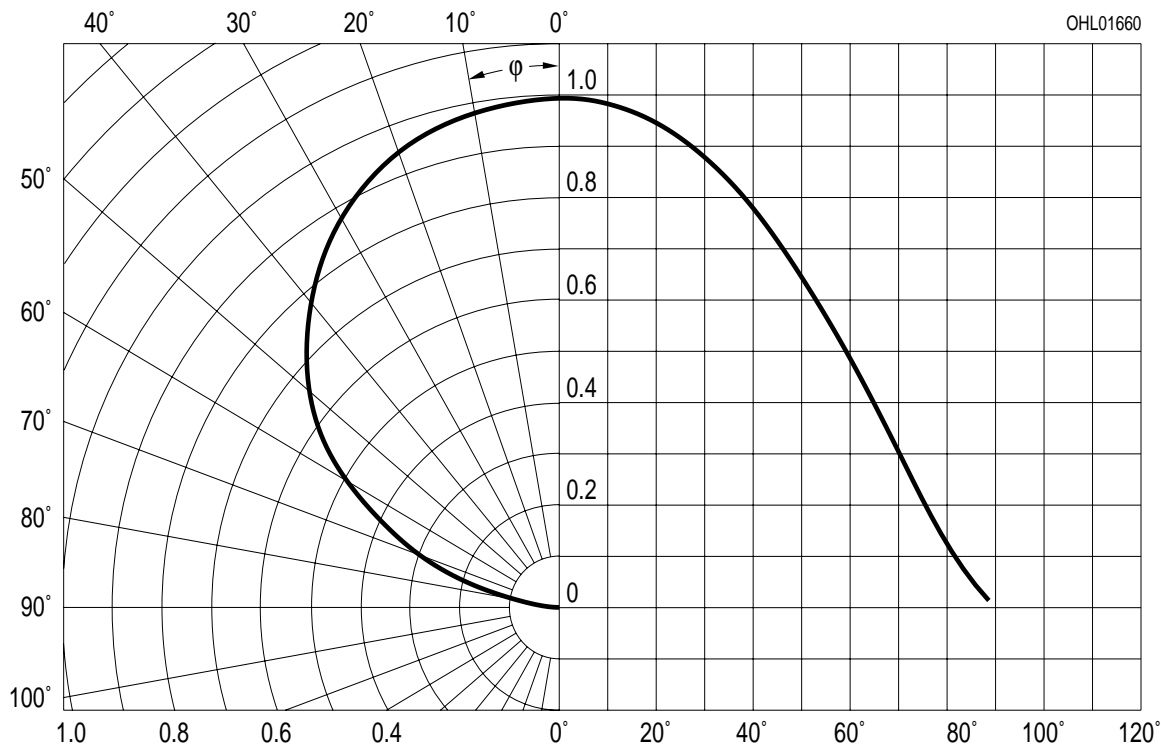

Durchlaßstrom $I_F = f(V_F)$

Forward current

$T_A = 25^\circ\text{C}$

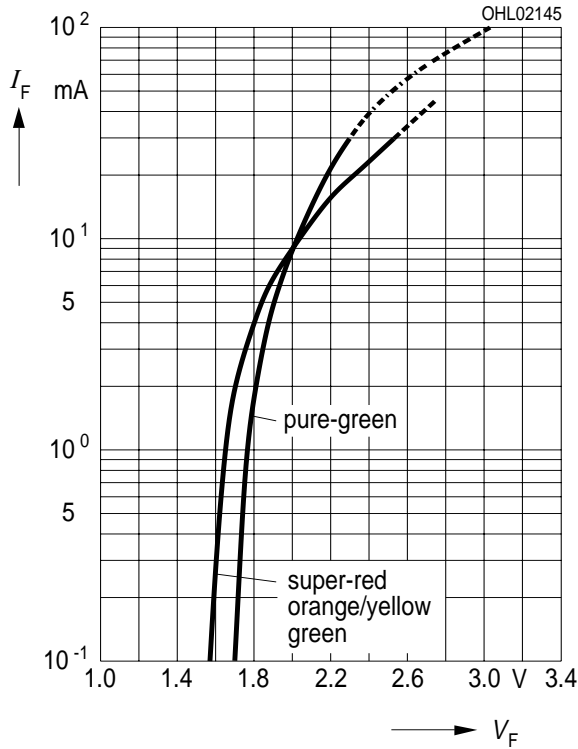

Relative Lichtstärke $I_V/I_{V(10\text{ mA})} = f(I_F)$

Relative luminous intensity

$T_A = 25^\circ\text{C}$

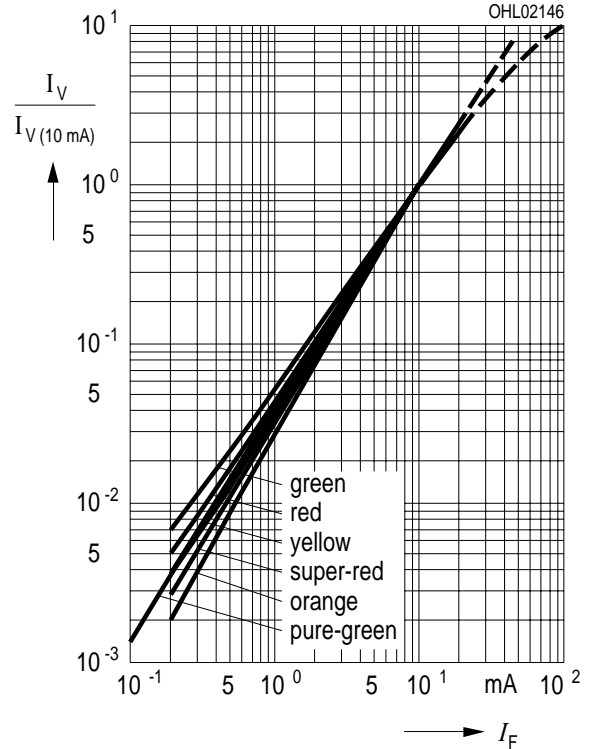

Zulässige Impulsbelastbarkeit $I_F = f(t_p)$

Permissible pulse handling capability

Duty cycle $D = \text{parameter}$, $T_A = 25^\circ\text{C}$

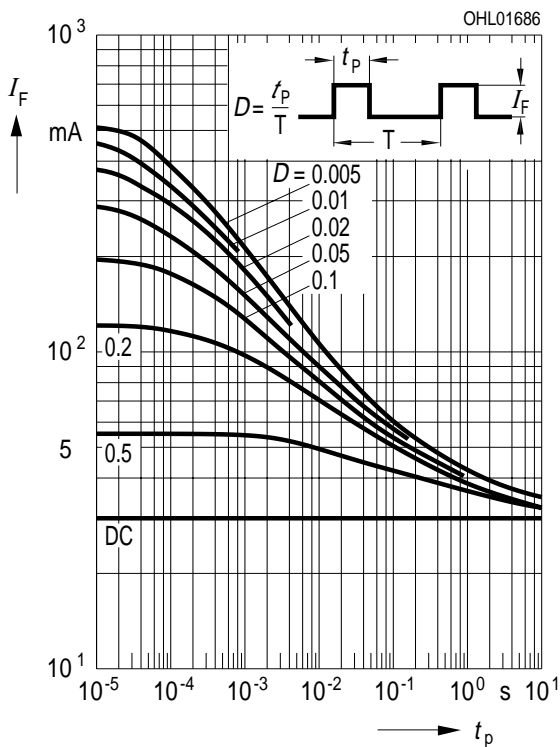

Maximal zulässiger Durchlaßstrom

Max. permissible forward current

$I_F = f(T_A)$

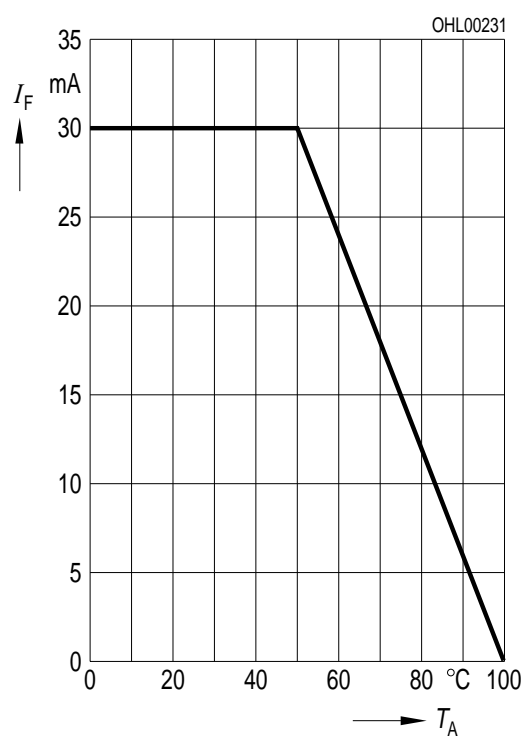

Wellenlänge der Strahlung $\lambda_{\text{peak}} = f(T_A)$
Wavelength at peak emission

$I_F = 10 \text{ mA}$

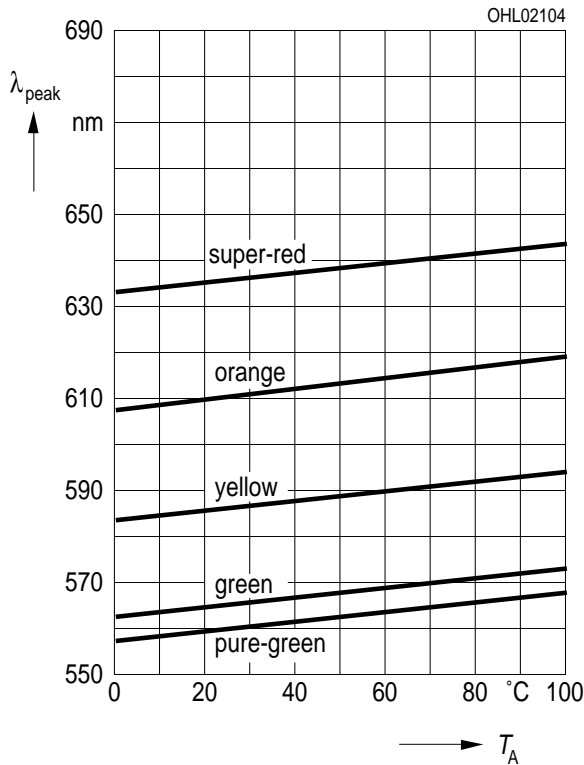

Dominantwellenlänge $\lambda_{\text{dom}} = f(T_A)$
Dominant wavelength

$I_F = 10 \text{ mA}$

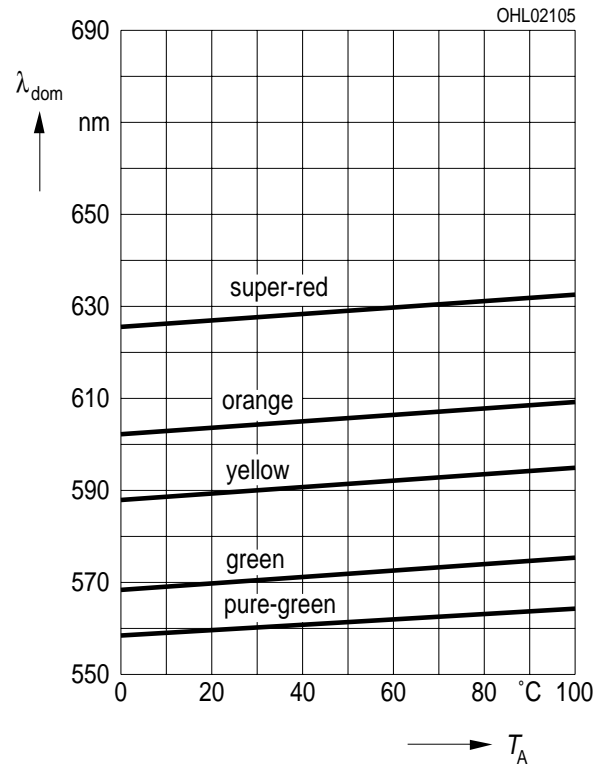

Durchlaßspannung $V_F = f(T_A)$
Forward voltage

$I_F = 10 \text{ mA}$

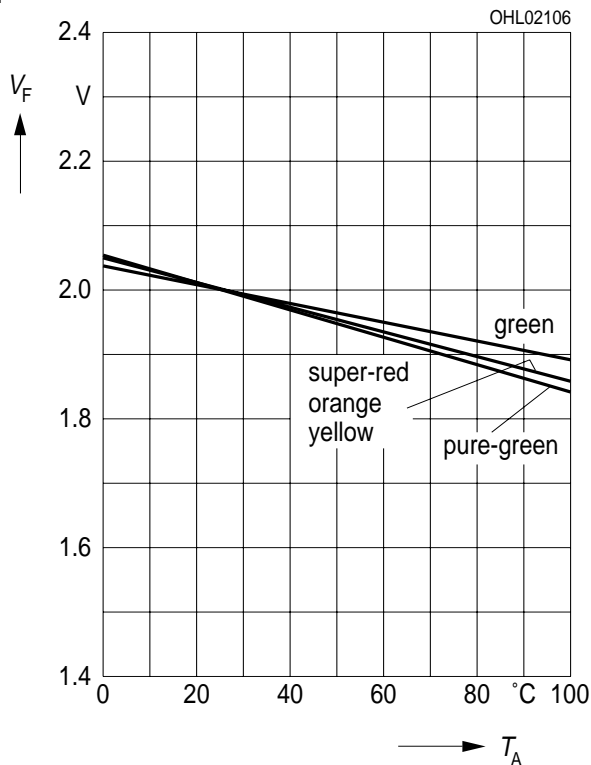

Relative Lichtstärke $I_V / I_{V(25^\circ\text{C})} = f(T_A)$
Relative luminous intensity

$I_F = 10 \text{ mA}$

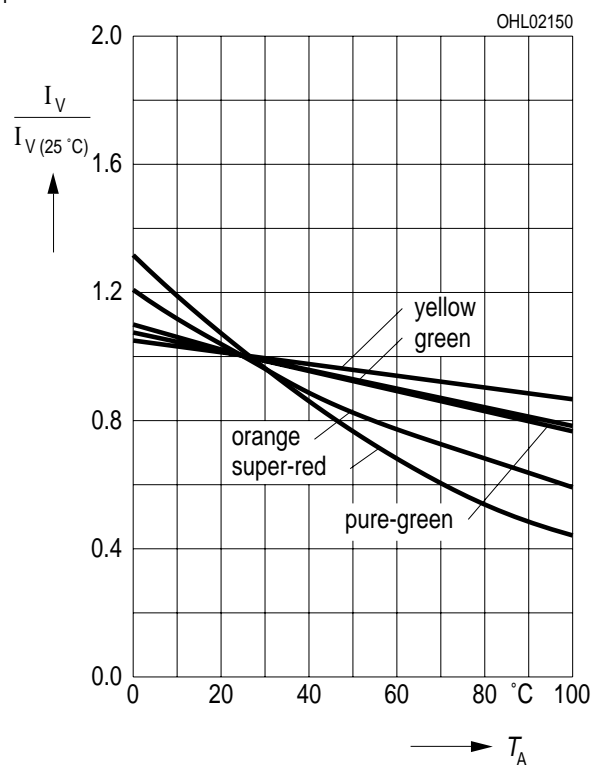

Maßzeichnung (Maße in mm, wenn nicht anders angegeben)
Package Outlines (Dimensions in mm, unless otherwise specified)

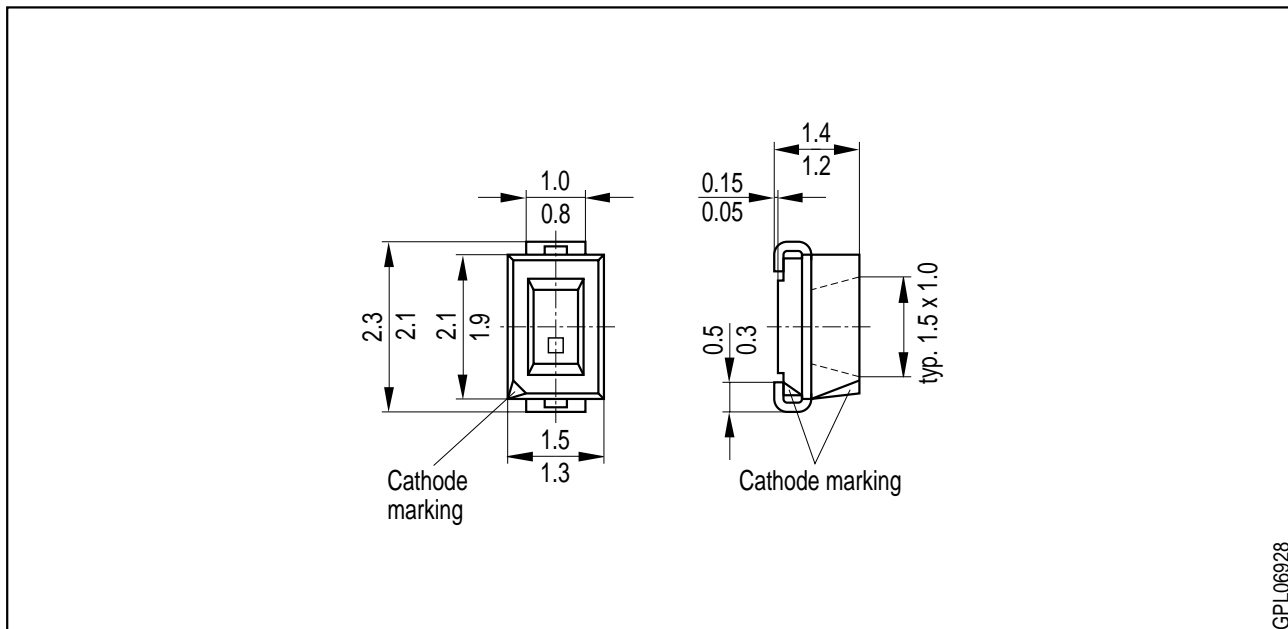

GPL06928

Kathodenkennung: abgeschrägte Ecke
Cathode mark: bevelled edge