

# JVC

ENGLISH  
DEUTSCH  
FRANÇAIS  
NEDERLANDS  
CASTELLANO  
ITALIANO  
PORTUGUÊS

[www.datasheet4u.com](http://www.datasheet4u.com)

InteriArt

**LT-32A61BU**  
**LT-32A61SU**  
**LT-26A61BU**  
**LT-26A61SU**

**HD**  
ready

**T-V LINK**

**WIDE LCD PANEL TV**

**INSTRUCTIONS**

**16:9 LCD TV**

**BEDIENUNGSANLEITUNG**

**TELEVISEUR A ECRAN LCD PANORAMIQUE**

**MANUEL D'INSTRUCTIONS**

**BREEDBEELD LCD TV**

**GEBRUIKSAANWIJZING**

**TELEVISOR CON PANEL LCD PANORÁMICO**

**MANUAL DE INSTRUCCIONES**

**TV LCD WIDESCREEN**

**ISTRUZIONI**

**TELEVISOR COM ECRÃ PANORÂMICO DE  
CRISTAL LÍQUIDO**

**INSTRUÇÕES**

[www.DataSheet4U.com](http://www.DataSheet4U.com)

[www.datasheet4u.com](http://www.datasheet4u.com)

Thank you for buying this JVC LCD flat television.

To make sure you understand how to use your new TV, please read this manual thoroughly before you begin. ("LCD" stands for Liquid Crystal Display.)

**WARNING: TO PREVENT FIRE OR SHOCK HAZARD, DO NOT EXPOSE THIS APPLIANCE TO RAIN OR MOISTURE.**

**WARNING**

- The TV may fall causing injuries. Hold the bottom of the stand with your hand and tilt the TV up and down.
- Do not allow children to hang from the TV, place their elbows on the TV or lean against the TV. Doing so may cause the TV to fall over and lead to injuries.

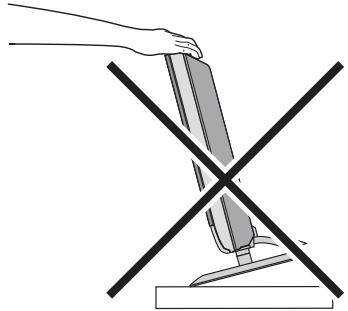

**CAUTION**

- The TV screen may be damaged if the TV is carried as shown in the diagram below. The TV should always be carried by two people.

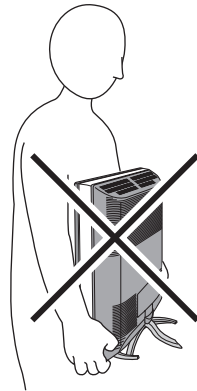

**Pixel defects**

LCDs use collections of fine points ("pixels") to display images. While there is no problem with more than 99.99% of these pixels, please understand that a very small number of pixels may not light, or may light all the time.

**Distance recommendations**

Avoid improper installation and never position the unit where good ventilation is impossible.

When installing this TV, distance recommendations must be maintained between the set and the wall, as well as inside a tightly enclosed area or piece of furniture. Keep to the minimum distance guidelines shown for safe operation.

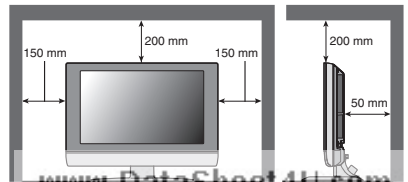

**Failure to take the following precautions may cause damage to the television or remote control.**

**DO NOT block the TV's ventilation openings or holes.**

(If the ventilation openings or holes are blocked by a newspaper or cloth, etc., the heat may not be able to get out.)

**DO NOT place anything on top of the TV.**

(such as cosmetics or medicines, flower vases, potted plants, cups, etc.)

**DO NOT allow objects or liquid into the cabinet openings.**

(If water or liquid is allowed to enter this equipment, fire or electric shock may be caused.)

**DO NOT place any naked flame sources, such as lighted candles, on the TV.**

**DO NOT subject the TV to direct sunlight.**

[www.datasheet4u.com](http://www.datasheet4u.com)

The surface of the TV screen is easily damaged. Be very careful with it when handling the TV. Should the TV screen become soiled, wipe it with a soft dry cloth. Never rub it forcefully. Never use any cleaner or detergent on it.

If there is a fault, unplug the unit and call a service technician. Do not attempt to repair it yourself or remove the rear cover.

■ **Cleaning the screen**

The screen is coated with a special thin film to reduce reflection. If this film is damaged, uneven colors, discoloration, scratches, and other problems that cannot be repaired may occur. Pay attention to the following when handling the screen.

- Do not use glue or adhesive tape on the screen.
- Do not write on the screen.
- Do not allow the screen to come in contact with any hard objects.
- Do not allow condensation to form on the screen.
- Do not use alcohol, thinner, benzene or other solvents on the screen.
- Do not rub the screen hard.

---

**CAUTION:**

- Operate only from the power source specified (AC 110 – 240 V, 50/60 Hz) on the unit.
  - Avoid damaging the AC plug and power cord.
  - When you are not using this unit for a long period of time, it is recommended that you disconnect the power cord from the main outlet.
-

# CONTENTS

<b>Setting up your TV</b> .....	<b>4</b>	<b>PICTURE menu</b> .....	<b>25</b>
Installation .....	4	PICTURE MODE.....	25
Using the stand .....	4	BRIGHT-1 .....	25
Removing the terminal cover .....	5	CONTRAST .....	25
Connecting the aerial and video cassette recorder (VCR).....	6	BRIGHT-2 .....	25
Connecting the power cord to the AC outlet.....	7	SHARP .....	25
Putting the batteries into the remote control.....	7	COLOUR.....	25
Initial settings .....	7	HUE.....	25
T-V LINK functions.....	10	COLOUR TEMP.....	25
<b>TV buttons and functions</b> .....	<b>12</b>	FEATURES .....	26
Turn the TV on from standby mode .....	12	<b>SOUND menu</b> .....	<b>28</b>
Choose a TV channel .....	12	STEREO / I • II .....	28
Watch images from external devices .....	12	BASS.....	28
Adjust the volume .....	13	TREBLE .....	28
Using the Menu.....	13	BALANCE .....	28
<b>Remote control buttons and functions</b> .....	<b>14</b>	3D SOUND.....	28
Turn the TV on or off from standby mode .....	14	<b>FEATURES menu</b> .....	<b>29</b>
Choose a TV channel and watch images from external devices .....	15	SLEEP TIMER .....	29
Adjust the volume .....	16	CHILD LOCK.....	29
Information function .....	16	APPEARANCE.....	30
ZOOM function.....	17	BLUE BACK.....	30
3D SOUND function.....	18	FAVOURITE SETTING .....	31
Return to TV channel instantly.....	18	<b>SET UP menu</b> .....	<b>32</b>
Favourite channel function.....	19	AUTO PROGRAM.....	32
Operating a JVC brand VCR or DVD player.....	20	EDIT/MANUAL .....	32
<b>Teletext function</b> .....	<b>21</b>	LANGUAGE .....	36
Basic operation .....	21	DECODER (EXT-2).....	36
Using the List Mode .....	21	EXT SETTING.....	37
Hold.....	22	<b>Additional preparation</b> .....	<b>40</b>
Sub-page .....	22	Connecting external equipment .....	40
Reveal.....	22	<b>CH/CC numbers</b> .....	<b>44</b>
Size .....	22	<b>Troubleshooting</b> .....	<b>46</b>
Index .....	23	<b>Cable management</b> .....	<b>49</b>
Cancel.....	23	<b>Specifications</b> .....	<b>50</b>
<b>Using the TV's menu</b> .....	<b>24</b>		
Basic operation .....	24		

# Setting up your TV

---

- When you install the TV on the wall, only use a JVC wall mounting unit (optional) which is designed for this TV.
- Make sure that the TV is installed on the wall by a skilled installer.

---

## Installation

---

### Cautions for installation

- Install the TV in a corner on a wall or on the floor so as to keep cords out of the way.
- The TV will generate a slight amount of heat during operation. Ensure that sufficient space is available around the TV to allow satisfactory cooling. See “Distance recommendations” on page 1.

---

## Using the stand

---

### This TV comes with a table top stand already attached.

This stand can be used to adjust the direction of the TV screen to the left or right.

#### ■ Rotate the TV to the left and right:

While holding the bottom of the stand with one hand, use your other hand to hold the edge of the panel and slowly adjust the direction of the TV screen.

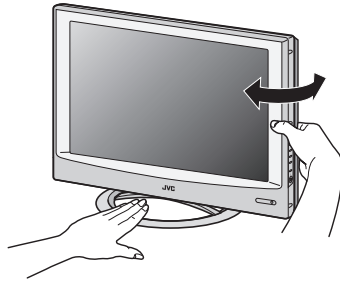

---

## Removing the terminal cover

---

There are connection terminals behind the cover on the rear of the TV. Remove the cover before connecting an antenna or VCR.

Remove the cover by removing the hooks.  
When replacing the cover, place the side of the cover against the TV and insert the hooks.

[www.datasheet4u.com](http://www.datasheet4u.com)

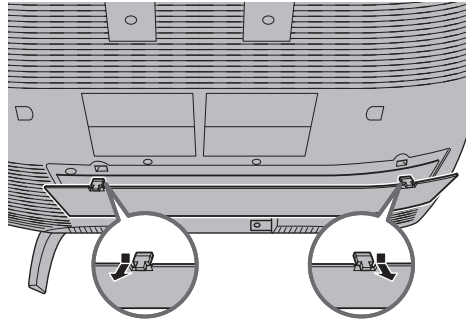

- 
- Leave the cover off if they do not fit properly. Do not force to replace the cover. Doing so may cause damage to the connection cables and the cover.
-

## Connecting the aerial and video cassette recorder (VCR)

- The connecting cables are not provided.
- For further details, refer to the manuals provided with the devices to be connected.

### Caution

- Turn off all the equipment including the TV before connecting anything.

■ If you are connecting a VCR, follow ① → ② → ③ in the diagram opposite.

■ If you are not connecting a VCR, follow ①.

To use the T-V LINK functions, you must have a T-V LINK compatible VCR connected by a SCART cable ③ to the EXT-2 terminal on the TV. For details about T-V LINK functions, see “T-V LINK functions” on page 10.

- You can watch a video using the VCR without doing ③. For details, see your VCR instruction manual.
- To connect more equipment, please see “Connecting external equipment” on page 40.
- If you connect a decoder to a T-V LINK compatible VCR, set the DECODER (EXT-2) function to ON. For details, see “DECODER (EXT-2)” on page 36. Otherwise, you will not be able to watch scrambled channels.

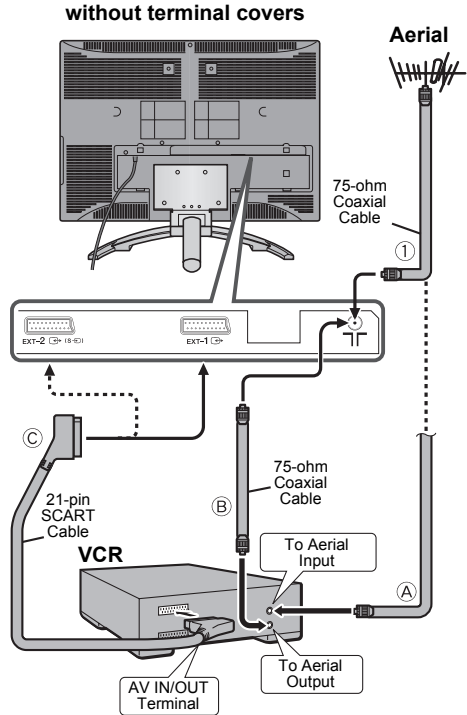



## Connecting the power cord to the AC outlet

Insert the AC plug on the power cord from the TV into an AC outlet.

### Caution

- Operate only from the power source specified (AC 110 – 240 V, 50/60 Hz) on the unit.

- Remove the AC plug from the outlet to completely disconnect the TV from the power supply.

## Putting the batteries into the remote control

Use two AA/R6 dry cell batteries. Insert the batteries from the  $\ominus$  end, making sure the  $\oplus$  and  $\ominus$  polarities are correct.

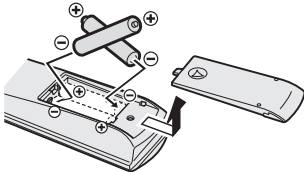

- Follow the warnings printed on the batteries.
- Battery life is about six months to one year, depending on how much you use the remote control.
- The batteries we supply are only for setting up and testing your TV, please replace them as soon as you need to.
- If the remote control does not work properly, replace the batteries.

## Initial settings

When the TV is first turned on, it goes into the initial settings mode, and you will see the JVC logo. Follow the instructions on the screen display to make the initial settings.

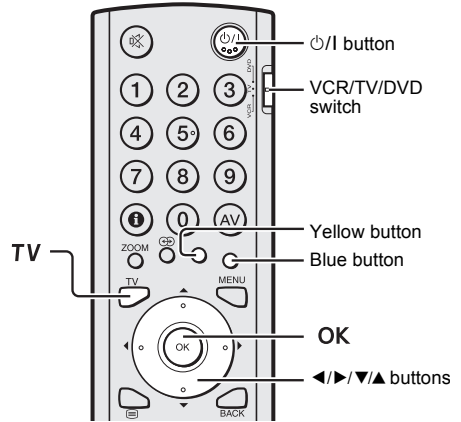

### 1 Make sure to set the VCR/TV/DVD switch on the remote control to the TV position

- You cannot turn the TV on when the VCR/TV/DVD switch is set to the VCR or DVD position.

### 2 Press the $\odot$ /I button on the remote control

The TV turns on from standby mode and the JVC logo is displayed.

- Check that the AC plug on the power cord from the TV is connected to AC outlet.

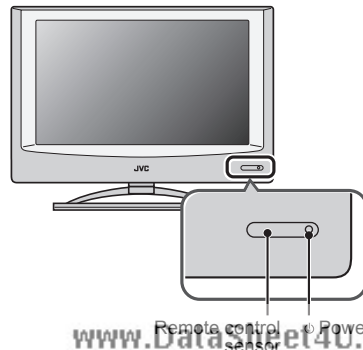

Remote control sensor Power lamp sensor

- If the JVC logo does not appear this is because your TV has already been turned on for the first time: use the “LANGUAGE” and “AUTO PROGRAM” functions to make the initial settings. For details, see “SET UP menu” on page 32.

**3 Press the OK button**

The LANGUAGE menu appears.

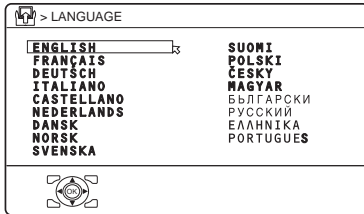

D0002(E)-EN

**4 Press the ▼/▲ buttons to choose ENGLISH. Then press the OK button**

The on-screen display will then be in English. The COUNTRY menu appears as a sub-menu of the AUTO PROGRAM function. There are two COUNTRY menus. Pressing the yellow button changes the COUNTRY menu as follows:

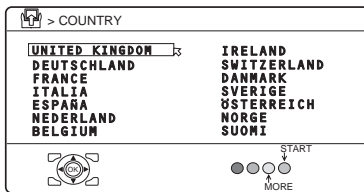

D0003-EN

**5 Press the ◀/▶ and ▼/▲ buttons to choose the country where you are**

**6 Press the blue button to start the AUTO PROGRAM function**

The AUTO PROGRAM menu appears and received TV channels are automatically stored in the programme numbers (PR).

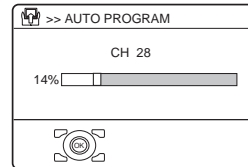

D0004-EN

- To cancel the AUTO PROGRAM function: Press the OK button.



**After the TV channels have been registered in the programme numbers (PR), the EDIT menu appears**

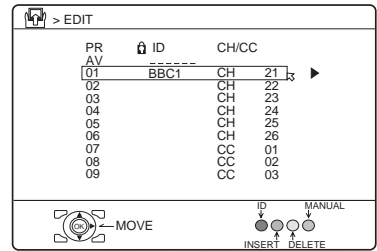

D0038-EN

- If you want to, you can now edit the programme numbers (PR) using the EDIT/MANUAL function. For details, see “EDIT/MANUAL” on page 32.
- If you do not want to edit programme numbers (PR), go to the next step.

## 7 Press the OK button to display the T-V LINK menu

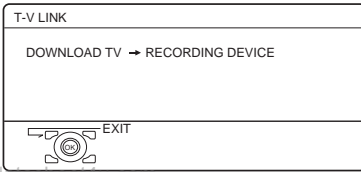

www.datasheet4u.com

### If you do not have a T-V LINK compatible VCR connected:

Press the **TV** button to exit the T-V LINK menu.

The T-V LINK menu disappears.

### If you have a T-V LINK compatible VCR connected to the EXT-2 terminal:

Follow the operating procedure "Downloading the data to VCR" on page 10 to transmit the Programme number (PR) data.

### Now, the initial settings are complete, and you can watch the TV

- If your TV can detect the TV channel name from the TV channel broadcast signal, the TV channel name is assigned to the programme number (PR) to which the TV channel has been set. However, which TV channels are set to which programme numbers (PR) will depend on the area in which you live.
- If a TV channel you want to view is not set to a programme number (PR), you can set it using the MANUAL function. For details, see "EDIT/MANUAL" on page 32.
- The AUTO PROGRAM function does not set the programme number PR 0 (AV) for your video cassette recorder. You will need to set this using the MANUAL function.

■ **Downloading the data to VCR**

You can transmit to the latest Programme numbers (PR) data to a VCR with the T-V LINK function.

**Caution**

- This only works when a T-V LINK compatible VCR is connected to the EXT-2 terminal.
- This only works when the T-V LINK menu is being displayed.

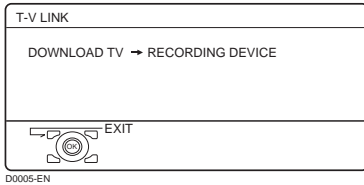

**1 Turn on the VCR**

**2 Press the OK button**

The data transmission begins.

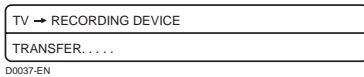

The T-V LINK menu disappears once the data transmission ends.

**When the T-V LINK menu is changed over to another menu:**

The TV has finished its menu. This new menu is operated from the VCR. See the VCR instruction manual for what to do next.

**If “FEATURE NOT AVAILABLE” appears at the T-V LINK menu:**

Check the following three items. Then press the ◀ button to retry data transmission.

- Has a T-V LINK compatible VCR been connected to the EXT-2 terminal?
- Has the VCR power been turned on?
- Does the SCART cable that is connected to the EXT-2 terminal to T-V LINK compatible VCR have all its proper connections?

**T-V LINK functions**

When you have a T-V LINK compatible VCR connected to the EXT-2 Terminal on the TV, it is easier to set up the VCR and to view videos. T-V LINK uses the following features:

**To use T-V LINK functions:**

A “T-V LINK compatible VCR” means a JVC video cassette recorder with the T-V LINK logo, or with one of the following logos. However, these VCRs may support some or all of the features described earlier. For details, see your VCR instruction manual.

- “Q-LINK” (a trademark of Panasonic Corporation)
- “Data Logic” (a trademark of Metz Corporation)
- “Easy Link” (a trademark of Phillips Corporation)
- “Megalogic” (a trademark of Grundig Corporation)
- “SMARTLINK” (a trademark of Sony Corporation).

## ■ Pre-set download

The VCR will automatically download the registered data on the TV channels from the TV. This means you do not need to set up the program channels on your VCR manually. The preset download function automatically begins when the initial setting is complete or whenever you carry out the AUTO PROGRAM or EDIT/MANUAL functions. You can also carry out this function using your VCR controls.

### When “FEATURE NOT AVAILABLE” is displayed:

If “FEATURE NOT AVAILABLE” is displayed, the download was not performed correctly. Before trying to download again, check that:

- the VCR power is turned on
- the VCR is T-V LINK compatible
- the VCR is connected to the EXT-2 terminal
- the SCART cable is fully wired.

## ■ Direct Rec

“What You See Is What You Record”

You can easily record to VCR the images that you are watching on the TV.

For details, read the manual for your VCR. Use your VCR controls. “DEVICE IS RECORDING” is displayed.

**In the following situations, the VCR will stop recording if the TV is turned off, if the TV channel or input is changed, or if the menu is displayed on the TV:**

- when recording images from an external device connected to the TV (for example a camcorder)
- when recording a TV channel after it has been unscrambled on a decoder
- when recording a TV channel by using the TV’s output because the VCR’s own tuner cannot properly receive that channel.

You cannot carry out Direct Rec using your TV’s control.

Generally, the VCR cannot record a TV channel that it cannot receive properly on its own tuner, even if you can view that TV channel on the TV. However, some VCRs can record a TV channel by using the TV’s output if that channel can be viewed on the TV. For details, see your VCR instruction manual.

When the VCR is not ready, the following messages are displayed.

ERROR MESSAGE	Cause and countermeasure
NO RECORDING	The VCR is not able to record. Check the VCR.
NO RECORDING POSSIBLE	The TV input is set to EXT-4 or PC. Since the EXT-4 picture or PC picture cannot be output to EXT-2, DIRECT REC is not possible.
NO RECORDING, MEDIA PROBLEM	The recording device is not ready to record. Check the VCR tape.
NO RECORDING, DEVICE BUSY	The recording device cannot record as it is recording or playing. Check the VCR.

Refer to the VCR instruction manual.

# TV buttons and functions

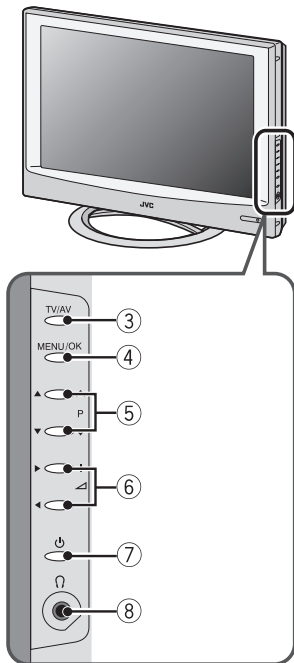
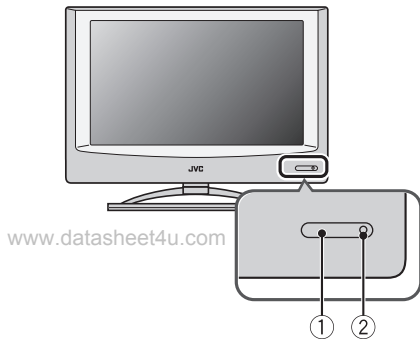

Refer to the pages in parentheses for details.

- ① Remote control sensor
- ② Power lamp (page 7)
- ③ TV/AV button (page 12)
- ④ MENU/OK button (pages 13, 24)
- ⑤ P  $\nabla/\Delta$  buttons (page 12)
- ⑥  $\nabla/\Delta$  (Volume)  $-/+$  buttons (page 13)
- ⑦  $\odot$  (Stand by) button (page 12)
- ⑧ Headphone jack (mini jack) (page 40)

## Turn the TV on from standby mode

Press the  $\odot$  button or the P  $\nabla/\Delta$  buttons to turn the TV on from standby mode.

When the TV is turned on, the power lamp lights blue.

**To turn the TV off:**

Press the  $\odot$  button again.  
The power lamp goes off.

## Caution

- The  $\odot$  button on the TV does not fully isolate the TV from the AC supply. If you are not going to use the TV for a long period, be sure to disconnect the AC plug from the AC socket.

## Choose a TV channel

Press the P  $\nabla/\Delta$  buttons to choose a programme number (PR) or an EXT terminal

## Watch images from external devices

Press the TV/AV button to choose an EXT terminal

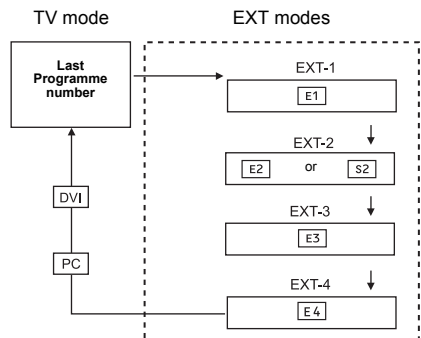

---

## Adjust the volume

---

### Press the (Volume) -/+ buttons

The volume level indicator appears.

---

## Using the Menu

---

### Use the MENU/OK button

Refer to “Using the TV’s menu” (see page 24) for details of using the menu.

# Remote control buttons and functions

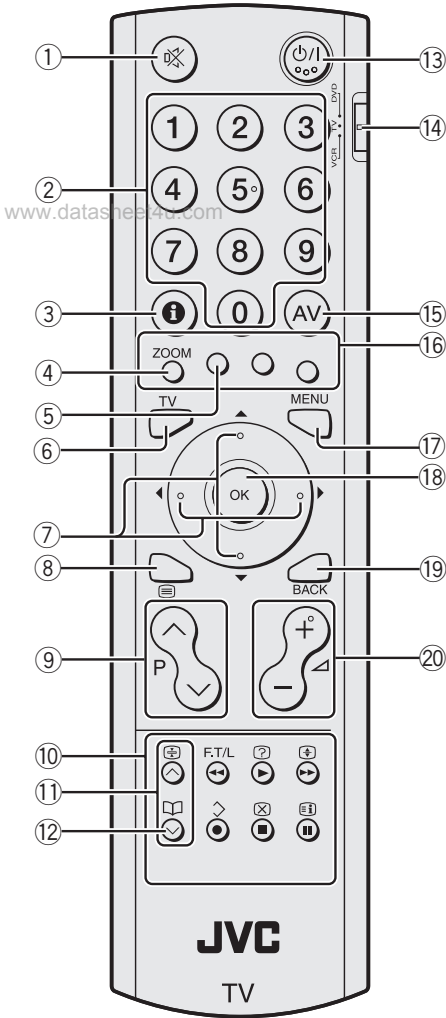

- ① Muting button
- ② Number buttons
- ③ Information button
- ④ **ZOOM** button
- ⑤ ↻ button
- ⑥ **TV** button
- ⑦ ◀/▶/▼/▲ buttons
- ⑧ ≡ (Text) button
- ⑨ **P** ∇/▲ buttons
- ⑩ VCR/DVD/Teletext control buttons
- ⑪ ∇/▲ buttons
- ⑫ 📖 (Favourite) button
- ⑬ ⏻/⏼ (Standby) button
- ⑭ VCR/TV/DVD switch
- ⑮ **AV** button
- ⑯ Colour buttons
- ⑰ **MENU** button
- ⑱ **OK** button
- ⑲ **BACK** button
- ⑳ ◀/▶ (Volume) -/+ buttons

## Turn the TV on or off from standby mode

### Press the ⏻/⏼ (standby) button to turn the TV on or off

When the TV is turned on, the power lamp lights blue.

- The power can be turned on by pressing the **TV** button, **P** ∇/▲ buttons or Number buttons.

To turn the TV on or off, set the VCR/TV/DVD switch on the remote control to the TV position and press the ⏻/⏼ button. If the VCR/TV/DVD switch on the remote control is set to a position other than TV, the TV will not be turned on or off even if the ⏻/⏼ button is pressed.



## Choose a TV channel and watch images from external devices

### ■ Use the number buttons: Enter the programme number (PR) of the channel using the number buttons.

www.DataSheet4U.com

Example:

- PR 6 → press **6**
- PR 12 → press **1** and **2**

### ■ Use the **P** $\nabla/\blacktriangle$ buttons: Press the **P** $\nabla/\blacktriangle$ buttons to choose the programme number (PR) you want or an EXT terminal.

### ■ Use the **AV** button: Press the **AV** button to choose an EXT terminal.

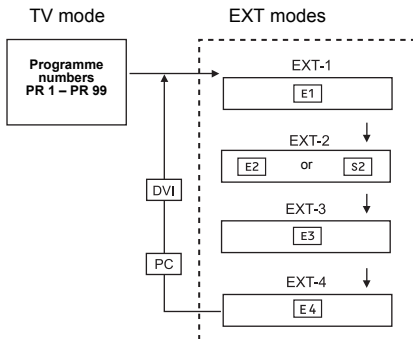

- You can choose a video input signal from the S-VIDEO signal (Y/C signal) and regular video signal (composite signal). For details, see “S-IN (S-VIDEO input)” on page 37.
- If you do not have a clear picture or no colour appears, change the colour system manually. See “COLOUR SYSTEM” on page 26.
- If you choose an EXT terminal with no input signal, the EXT terminal number becomes fixed on the screen.

- Since this TV is designed to make full use of the resolution of the original video source, the motion may appear unnatural when the video source is input with progressive-scanning component signals. If this happens, change the output setting of the connected device to interlace-scanning component signal output. See the instructions that came with the device for more information.
- The PC sound is the same as the EXT-3 sound.

### To return to a TV channel:

Press the **TV** button, the  $\nabla/\blacktriangle$  buttons or the number buttons.

### To use the programme number PR 0 (AV):

When the TV and VCR are connected only by the aerial cable, choosing the programme number PR 0 (AV) allows you to view images from the VCR. Set the VCR RF channel to the programme number PR 0 (AV) manually. For details, see “EDIT/MANUAL” on page 32.

Pressing the **AV** button changes the choice as follows:

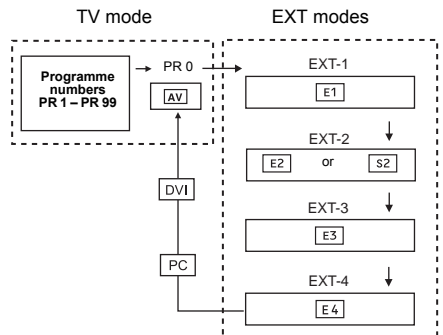

- The VCR sends its playback image along the aerial cable as an RF (radio frequency) signal.
- Also see your VCR instruction manual.

## Adjust the volume

Press the buttons to adjust the volume.

The volume level indicator appears and the volume changes as you press the buttons.

### ■ Muting the sound

Press the (muting) button to turn off the sound.

Pressing the (muting) button again restores the previous volume level.

## Information function

You can see the channel number of the programme you are watching, the current time or the PR LIST.

From the PR LIST, you can choose a channel or EXT terminal.

Press the (Information) button to display the information you want to see.

Pressing the (Information) button changes the display as follows:

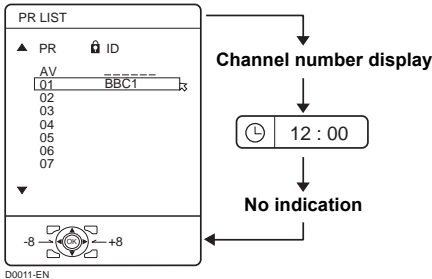

### Channel number display:

The channel number and channel name (when the channel name is registered) of the programme you are watching or the EXT terminal number is displayed.

### Time display:

The current time of the teletext data is displayed.

If the TV has not received a TV channel that has teletext programmes since it was turned on, the time display is blank. To view the current time, choose a TV channel that has teletext programmes.

- An incorrect current time is sometimes displayed when watching videos.

### PR LIST:

The programme number (PR) and EXT terminal list is displayed.

Pressing the **OK** button after choosing the programme number (PR) or EXT terminal with the buttons will display the chosen programme or EXT terminal.

- For programme numbers (PR) for which the CHILD LOCK function is set, the (CHILD LOCK) mark is displayed. For details see “CHILD LOCK” on page 29.
- For programme numbers (PR) which is registered as a favourite channel, the (favourite) mark is displayed. For details see “Favourite channel function” on page 19.

## ZOOM function

You can change the screen size according to the picture aspect ratio. Choose the optimum one from the following ZOOM modes.

- The ZOOM mode is fixed at FULL when you are using the TV as a PC screen.

### AUTO:

When a WSS (Wide Screen Signalling) signal, which shows the aspect ratio of the picture, is included in the broadcast signal or the signal from an external device, the TV automatically changes the ZOOM mode to 16:9 ZOOM mode or FULL mode according to the WSS signal.

If a WSS signal is not included, the picture is displayed according to the ZOOM mode set with the 4:3 AUTO ASPECT function.

- For details of the 4:3 AUTO ASPECT function, see “4:3 AUTO ASPECT” on page 27.
- When the AUTO (WSS) mode does not function correctly due to poor WSS signal quality or when you want to change the ZOOM mode, press the **ZOOM** button and change to another ZOOM mode.

### REGULAR:

Use to view a normal picture (4:3 aspect ratio) as this is its original shape.



### PANORAMIC:

This stretches the left and right sides of a normal picture (4:3 aspect ratio) to fill the screen, without making the picture appear unnatural.

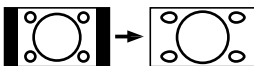

- The top and bottom of the picture are slightly cut off.

### 14:9 ZOOM:

This zooms up the wide picture (14:9 aspect ratio) to the upper and lower limits of the screen.



### 16:9 ZOOM:

This zooms up the wide picture (16:9 aspect ratio) to the full screen.

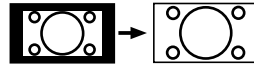

### 16:9 ZOOM SUBTITLE:

This zooms up the wide picture (16:9 aspect ratio) with subtitles to the full screen.

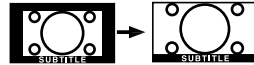

### FULL:

This uniformly stretches the left and right sides of a normal picture (4:3 aspect ratio) to fill the wide TV screen.

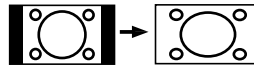

- For 16:9 aspect ratio pictures that have been squeezed into a normal picture (4:3 aspect ratio), use the FULL mode to restore the picture to its original shape.

## ■ Choose the ZOOM mode

### 1 Press the **ZOOM** button to display the ZOOM menu

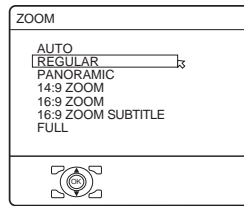

D0009-EN

### 2 Press the **▼/▲** buttons to choose a ZOOM mode. Then press the **OK** button

The picture expands and the chosen ZOOM mode is displayed in about 5 seconds.

- The ZOOM mode may be automatically changed by the control signal from an external device. When you want to return to the previous ZOOM mode, choose the ZOOM mode again.

■ **Adjusting the visible area of the picture**

If subtitles or the top (or bottom) of the picture are cut off, you can adjust the visible area of the picture manually.

---

**1 Press the ZOOM button**

The ZOOM menu appears.

---

www.Datasheet4U.com **2 Press the OK button to display the ZOOM mode indicator**

The indicator appears.



---

**3 While it is displayed, press the ▼/▲ buttons to change the position of the picture**

- You cannot adjust the visible area in REGULAR or FULL mode.

---

The visible area adjustment is saved even after the TV channel is changed. However, it is cancelled if the following operations are performed.

- The power is turned off/on
- The ZOOM mode is changed
- [Text] (Text) button is pressed
- The TV is switched between TV mode and EXT mode

---

## 3D SOUND function

---

You can enjoy sounds with a wider ambience.

- This function does not work for the sound from headphones.

---

**Press the [3D] button to select one of 3D SOUND modes**

**ON:**

When you listen to stereo sound, please select ON mode.

You can enjoy sound similar to the experience at the theatre.

**MONO:**

Select the MONO mode, when you listen to the mono sound.

You can enjoy the sound for a wider audience similar to stereo sound.

**OFF:**

The 3D SOUND function switches off.

- 
- You can choose the 3D SOUND mode with the “SOUND menu” (see page 28).
- 

---

## Return to TV channel instantly

---

You can return to a TV channel instantly.

---

**Press the TV button**

The TV returns to the TV mode and a TV channel appears.

---

## Favourite channel function

---

You can register your favourite TV channels (PR 1 – PR 99) in the number buttons 1 to 4. After registering, the channel can be called by pressing the  (favourite) button and a number button 1 to 4.

### ■ Favourite channel registration

[www.datasheet4u.com](http://www.datasheet4u.com)

#### 1 In the normal screen, choose a TV channel (PR 1 – PR 99) that you want to register

For details, refer to “Choose a TV channel and watch images from external devices” on page 15.

#### 2 Press and hold the (favourite) button for three seconds or more

Then “SET 1-4?” appears on the screen.

#### 3 Press one of the number buttons 1 to 4

The current channel is registered in the pressed number button.

After “PROGRAMMED!” appears on the screen, the favourite channel icon appears at the top-right of the screen.

- If the channel you are trying to register is already registered in one of the other number buttons 1 to 4, “NOT AVAILABLE” appears on the screen.
  - Channels locked with the CHILD LOCK function cannot be registered.
  - If AUTO PROGRAM is performed, the registered favourite channels are reset.
- 
- When you want to delete a favourite channel, delete the set channel and set contents with FAVOURITE SETTING (see page 31) in the FEATURES menu.
- 

### ■ Calling the favourite channel

#### 1 In the normal screen, press the (favourite) button

Then “FAVORITE1-4?” appears.

#### 2 Press one of the number buttons 1 to 4

The called favourite channel appears on the screen.

- If a number button in which no channel is registered is pressed, “NO MEMORY” appears on the screen.

### ■ Setting the picture effect

When a favourite channel has been chosen with the  (favourite) button and number buttons 1 to 4, picture effect settings can be memorised for each favourite channel by setting the picture effects in the PICTURE menu (see page 25).

The following items in the PICTURE menu (see page 25) are memorised.

PICTURE MODE  
 BRIGHT-1  
 CONTRAST  
 BRIGHT-2  
 SHARP  
 COLOUR  
 HUE  
 COLOUR TEMP.  
 DIGITAL VNR  
 COLOUR SYSTEM

The last setting made for each item is memorised.

---

## Operating a JVC brand VCR or DVD player

---

These buttons will operate a JVC brand VCR or DVD player. Pressing a button that looks the same as the device's original remote control button has the same effect as the original remote control.

---

### 1 Set the VCR/TV/DVD Switch to the VCR or DVD position

#### VCR:

When you are operating the VCR, set the switch to the VCR position.

- You can turn the VCR on or off with the  $\odot/I$  (standby) button.

#### DVD:

When you are operating the DVD player, set the switch to the DVD position.

- You can turn the DVD player on or off with the  $\odot/I$  (standby) button.
- You can also press the **MENU** or **TOP MENU** button and display the DVD disc menu screen, and then operate by pressing the  $\blacktriangleleft/\blacktriangleright/\blacktriangledown/\blacktriangleup$  buttons.

---

### 2 Press the VCR/DVD Control Button to control your VCR or DVD player

- If your device is not made by JVC, these buttons will not work.
- Even if your device is made by JVC, some of these buttons may not work, depending on the device you are using.
- You can use the  $\vee/\wedge$  buttons to choose a TV channel the VCR will receive, or choose the chapter the DVD player plays back.
- Some models of DVD player use the  $\vee/\wedge$  buttons for both operating the fast forward/backward functions and for choosing the chapter. In this case, the  $\blacktriangleleft/\blacktriangleright$  buttons do not work.

You cannot turn the TV on or off when the VCR/TV/DVD switch is set to the VCR or DVD position.

When you turn the TV on or off, set the VCR/TV/DVD switch to the TV position.

# Teletext function

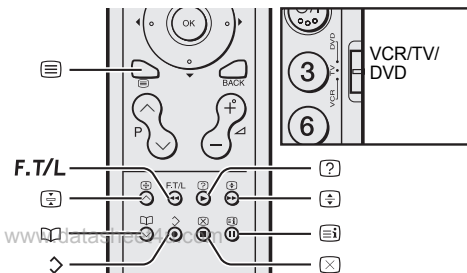

## Basic operation

- 1 Choose a TV channel with a teletext broadcast
- 2 Set the VCR/TV/DVD switch to the TV position



- 3 Press (Text) button to display the teletext

Pressing (Text) button changes the mode as follows:

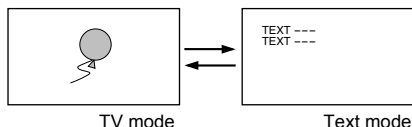

- 4 Choose a teletext page by pressing the P V/A buttons, number buttons or colour buttons

**To return to the TV mode:**

Press the **TV** button or (Text) button.

- If you have trouble receiving teletext broadcasts, consult your local dealer or the teletext station.
- The ZOOM function will not work in the TV and text mode or Text mode.
- You cannot operate menus when viewing a teletext programme.
- Language display depends on the country which was set on the COUNTRY menu. If characters on a Teletext programme do not appear properly, change the COUNTRY setting to other country's. To change the COUNTRY setting, perform steps 1 and 2 of the "AUTO PROGRAM" procedure on page 32 and then press the **OK** button.

## Using the List Mode

You can store the numbers of your favourite teletext pages in memory and call them up quickly using the colour buttons.

- **To store the page numbers:**

- 1 Press **F.T/L** button to go into the **List mode**

The page numbers you have stored are displayed at the bottom of the screen.

**2 Press a colour button to choose a position. Then press the number buttons to enter the page number**

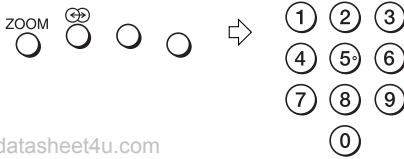

www.datasheet4u.com

**3 Press and hold down the ↵ (Store) button**

The four page numbers blink white to show that they are stored in memory.

**■ To call up a stored page:**

**1 Press the F.T/L button to enter the List mode**

**2 Press a colour button having a stored page**

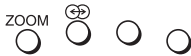

**To exit the List mode:**  
Press the F.T/L button again.

## Hold

You can hold a teletext page on the screen for as long as you want, even while several other teletext pages are being received.

**Press the ⏸ (Hold) button**

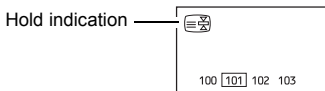

**To cancel the Hold function:**  
Press the ⏸ (Hold) button again.

## Sub-page

Some teletext pages include sub-pages that are automatically displayed. You can hold any sub-page, or view it at any time.

**1 Press the 📖 (Favourite) button to operate the Sub-page function**

**2 Press the Number buttons to enter a sub-page number**

Example:

- 3rd sub-page → press 0, 0, 0 and 3.

**To cancel the Sub-page function:**

Press the 📖 (Favourite) button again.

## Reveal

Some teletext pages include hidden text (such as answers to a quiz). You can display the hidden text.

**Each time you press the 🔍 (Reveal) button, text is hidden or revealed**

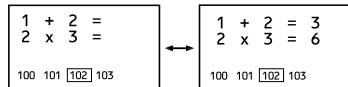

## Size

You can double the height of the teletext display.

**Press the ⏏ (Size) button**

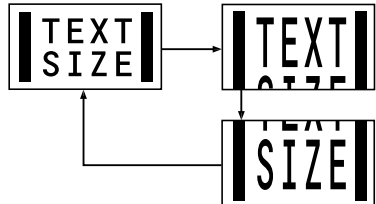



---

## Index

---

You can return to the index page instantly.

---

### **Press the (Index) button**

Returns to page 100 or a previously specified page.

---

---

## Cancel www.DataSheet4U.com

---

You can search for a teletext page while watching TV.

---

### **1 Press the number button to enter a page number, or press a colour button**

The TV searches for a teletext page.

---

### **2 Press (Cancel) button**

The TV programme appears. When the TV finds the teletext page, its page number appears in the upper left of the screen.

---

### **3 Press (Cancel) button to return to a teletext page when the page number is on the screen**

- The TV mode cannot be resumed by pressing the  (Cancel) button. To return to the TV mode press **TV**.

# Using the TV's menu

This TV has a number of functions you can operate using menus. To use all your TV's functions, you need to understand the basic menu operating techniques fully.

## Buttons used to operate the menus

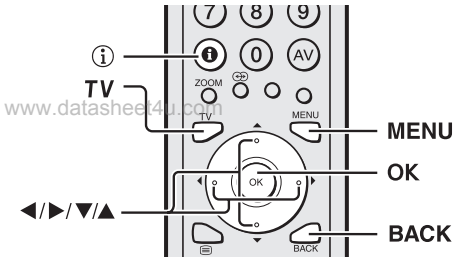

## Types of menu



D0106

### PICTURE menu

Choose to set the screen settings.



D0107

### SOUND menu

Choose to set the sound settings.



D0108

### FEATURES menu

Choose to set the sleep timer and child lock settings.



D0109

### SET UP menu

Choose to edit the channels or set the display language settings.

## Basic operation

- 1 Press the **MENU** button to display the menu bar



D0105-EN

- 2 Press the **◀/▶** buttons to choose the menu you want to use and then press the **OK** button



D1105-EN

- 3 Press the **▼/▲** buttons to choose the item to be set, press the **◀/▶** buttons to set the item, and then press the **OK** button

If there are sub-menus, use the **◀/▶/▼/▲** buttons to operate them.

- Press the **BACK** button to return to the previous menu.
- Press the **TV** or **MENU** button to exit from the menu.
- Some menu items may not be operated or set depending on the TV status or other menu item settings. Menu items that cannot be operated or set are displayed in grey in the menu and cannot be chosen.

- The menu will disappear after about one minute if no operation is performed.

## Operation with the buttons on the TV

You can also operate the menus using the buttons on the front panel of the TV.

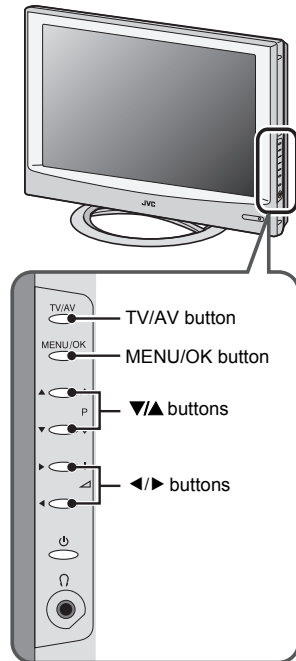

# PICTURE menu

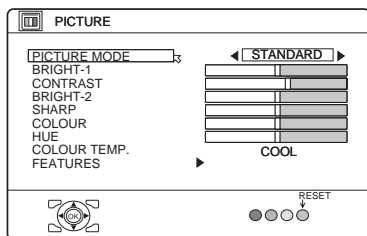

www.DataSheet4U.com

- While the PICTURE menu is displayed, pressing the blue button will set the BRIGHT-1, CONTRAST, BRIGHT-2, SHARP, COLOUR, HUE settings to their default settings.
- When watching the picture from EXT-1 to EXT-4 or the PC, picture effect settings can be memorised for each external input by setting the picture effects in the PICTURE menu.

The following items in the PICTURE menu are memorised.

PICTURE MODE  
BRIGHT-1  
CONTRAST  
BRIGHT-2  
SHARP  
COLOUR  
HUE  
COLOUR TEMP.  
DIGITAL VNR  
COLOUR SYSTEM

The last setting made for each item is memorised.

## PICTURE MODE

You can choose one of three PICTURE MODEs to adjust the picture settings automatically.

### BRIGHT:

Heightens contrast and sharpness.

### STANDARD:

Standardizes picture adjustment.

### SOFT:

Softens contrast and sharpness.

## BRIGHT-1

You can adjust the back light.

- ◀ : darker
- ▶ : brighter

## CONTRAST

You can adjust the picture contrast.

- ◀ : lower
- ▶ : higher

## BRIGHT-2

You can adjust the picture brightness.

- ◀ : darker
- ▶ : brighter

## SHARP

You can adjust the picture sharpness.

- ◀ : softer
- ▶ : sharper

## COLOUR

You can adjust the picture colour.

- ◀ : lighter
- ▶ : deeper

## HUE

You can adjust the picture tint.

- ◀ : reddish
- ▶ : greenish
- You can change the HUE setting (picture hue) when the colour system is NTSC 3.58, or NTSC 4.43.

## COLOUR TEMP.

You can select one of three COLOUR TEMP. modes (three tones of white) to adjust the white balance of the picture. Since white is the colour which is used as a reference for all the other colours, changing the COLOUR TEMP. mode affects the appearance of all the other colours on the screen.

**COOL:**

A bluish white. Using this mode when watching bright pictures allows you to enjoy a more vivid and bright picture.

**NORMAL:**

The normal white colour.

**WARM:**

A reddish white. Using this mode when watching films allows you to enjoy colours that are characteristic of films.

**FEATURES**

Choose FEATURES and press the **OK** or **▶** button to display the sub-menu.

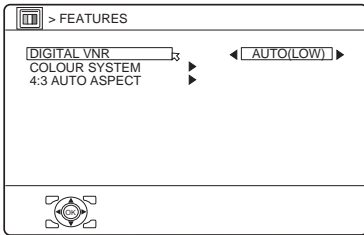

D1015-EN

■ **DIGITAL VNR**

The DIGITAL VNR function cuts down the amount of ‘noise’ (‘snow’ or interference) in the original picture.

**ON:**

This function is turned on.

**OFF:**

This function is turned off.

■ **COLOUR SYSTEM**

The colour system is chosen automatically. However, if the picture is not clear or no colour appears, choose the colour system manually.

**1 Choose COLOUR SYSTEM. Then press the OK or ▶ button**

The sub-menu of the COLOUR SYSTEM function appears.

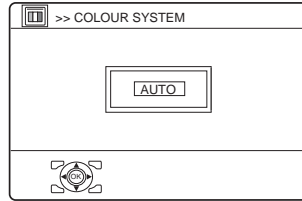

D0016-EN

**2 Press the ▼/▲ buttons to choose the appropriate colour system. Then press the OK button**

**PAL:**

PAL system

**SECAM:**

SECAM system

**NTSC 3.58:**

NTSC 3.58 MHz system

**NTSC 4.43:**

NTSC 4.43 MHz system

**AUTO:**

This function detects a colour system from the input signal. You can only use this when you are viewing a picture from programme number PR 0 (AV), or an EXT terminal.

- The AUTO function may not function properly if you have poor signal quality. If the picture is abnormal in the AUTO function, choose another colour system manually.
- When in the Programme numbers PR 0 (AV) to PR 99, you cannot choose NTSC 3.58 or NTSC 4.43.
- COLOUR SYSTEM cannot be chosen when you are watching the PC picture.

## ■ 4:3 AUTO ASPECT

You can choose one of three ZOOM modes, REGULAR, PANORAMIC or 14:9 ZOOM, as the ZOOM mode for the normal picture (4:3 aspect ratio).

- 1 Choose 4:3 AUTO ASPECT then press the OK button

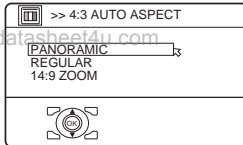

D0017-EN

- 2 Press the ▼/▲ buttons to choose a ZOOM mode

# SOUND menu

---

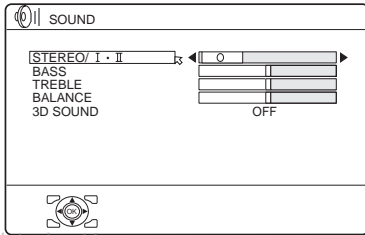

www.data-sheet4u.com

- When the headphones are connected, only “STEREO / I • II” can be used.

---

## STEREO / I • II

---

When you are viewing a bilingual broadcast programme, you can choose the sound from Bilingual I (Sub I) or Bilingual II (Sub II). If you have poor reception on a stereo broadcast, you can change from stereo to mono sound so that you can hear the broadcast more clearly and easily.

⊕ : Stereo sound

○ : mono sound

I : Bilingual I (sub I)

II : Bilingual II (sub II)

- 
- The sound mode you can choose differs depending on the TV programme.
  - This function does not work in the EXT modes.
- 

---

## BASS

---

You can adjust the low tone of the sound.

◀ : weaker

▶ : strong

---

## TREBLE

---

You can adjust the high tone of the sound.

◀ : weaker

▶ : strong

---

## BALANCE

---

You can adjust the volume balance between the left and right speaker.

◀ : turn the left speaker's volume level up.

▶ : turn the right speaker's volume level up.

---

## 3D SOUND

---

You can enjoy Surround sound with a “live” effect by using the 3D SOUND function.

- You can choose a 3D SOUND mode from ON, MONO and OFF modes. For details, see “3D SOUND function” on page 18.
- You can also operate the 3D SOUND function with the  button. For details, see “3D SOUND function” on page 18.

# FEATURES menu

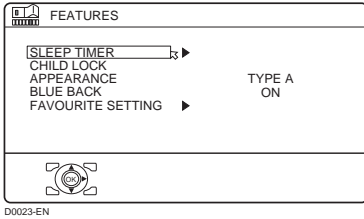

www.datasheet4u.com

## SLEEP TIMER

You can set the TV to automatically turn off after a set period of time.

### 1 Choose SLEEP TIMER. Then press the OK or ► button

A Sub-menu of the SLEEP TIMER function appears.

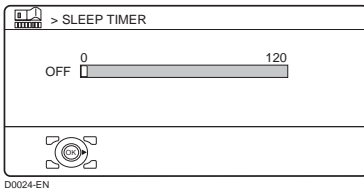

### 2 Press the ◀/▶ buttons to set the period of time. Then press the OK button

You can set the period of time for up to 120 minutes (2 hours) in 10 minute steps.

- One minute before the SLEEP TIMER function turns off the TV, “GOODNIGHT!” appears.
- The SLEEP TIMER function cannot be used to turn off the TV’s main power.
- When the SLEEP TIMER function is on, you can display the sub-menu of the SLEEP TIMER function again to confirm or change the remaining period of time of the SLEEP TIMER function. Press the OK button to leave the menu after confirming or changing the remaining time.

### To cancel the SLEEP TIMER function:

Press the ◀ button to set the period of time to “OFF”.

## CHILD LOCK

When there is a TV channel you do not want your children to watch, you can use the CHILD LOCK function to lock out the TV channel. Even when a child chooses a programme number (PR) for a locked TV channel the screen will change to blue and display  (CHILD LOCK) so the TV channel cannot be viewed. Unless you enter a pre-set ID number by a special operation, the lock cannot be released and the child cannot view the TV channel.

### ■ To set the CHILD LOCK function

#### 1 Choose CHILD LOCK, then press the 0 button

“SET ID NO.” (ID number setting screen) appears.

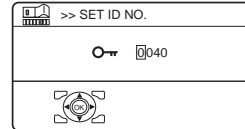

#### 2 Set the ID number to your liking

1 Press the ▼/▲ buttons to choose a number.

2 Press the ◀/▶ buttons to move the cursor.

#### 3 Press the OK button

The Sub-menu of CHILD LOCK appears.

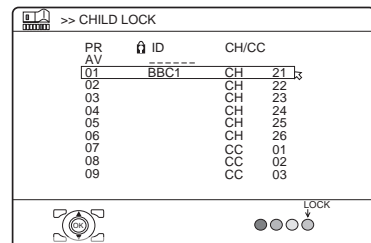

www.DataSheet4U.com

---

**4 Press the ▼/▲ buttons to choose a TV channel**

Every time you press the ▼/▲ buttons, the Programme number (PR) changes, and the picture of the TV channel registered in the Programme number (PR) is displayed on the screen.

---

**5 Press the blue button and set the CHILD LOCK function. Then press the OK button**

Ⓘ (CHILD LOCK) appears and the TV channel is locked.

**To reset the CHILD LOCK function:**

Press the blue button again.

Ⓘ (CHILD LOCK) disappears.

---

To disable easy resetting of the CHILD LOCK function, the menu disappears if you choose the CHILD LOCK function and press the **OK** button.

---

**■ To view a locked TV channel**

---

**1 Choose a programme number (PR) of a locked TV channel with the number buttons or PR LIST**

The screen changes to blue and the Ⓘ (CHILD LOCK) appears. You cannot view the TV channel.

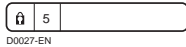

---

**2 Press the ⓘ (Information) button to display "ID NO." (ID No. input screen)**



---

**3 Press the number buttons to enter the ID number**

The lock is temporarily released so you can view the TV channel.

---

**If you have forgotten the ID number:**

Perform step 1 of "To set the CHILD LOCK function". After confirming the ID number, press the **TV** button to exit the menu.

- Even if you reset the lock temporarily, it does not mean that the CHILD LOCK function set for the TV channel is cancelled. The next time anyone tries to view the TV channel, it will be locked again.
- When you want to cancel the CHILD LOCK function, you must perform the operation "To set the CHILD LOCK function" again.
- To stop it being easy to choose the programme number (PR) of a locked TV channel, the programme number (PR) has been set so that it cannot be chosen with the ▼/▲ buttons or the buttons of the TV.
- To stop it being easy to reset the lock, "ID NO." (ID No. input screen) is set so that it cannot appear unless you press the ⓘ (Information) button.

---

**APPEARANCE**

Press the ◀/▶ button and choose the format in which the channel number is displayed from two types: TYPE A and TYPE B.

---

**BLUE BACK**

You can set the TV to automatically change to a blue screen and mute the sound if the signal is weak or absent, or when there is no input from an external device.

**ON:**

This function is turned on.

**OFF:**

This function is turned off.



## FAVOURITE SETTING

Chose when deleting the favourite channels registered in the buttons 1 to 4.

### 1 Choose FAVOURITE SETTING, then press the OK or ► button

The FAVOURITE SETTING menu appears.

[www.datasheet4u.com](http://www.datasheet4u.com)

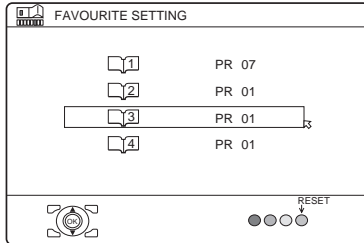

D0112-EN

### 2 Press the ▼/▲ buttons and chose the favourite channel that you want to delete

### 3 Press the blue button

The chosen favourite channel and set contents are deleted.

- For details of the favourite channels, see “Favourite channel function” on page 19.

# SET UP menu

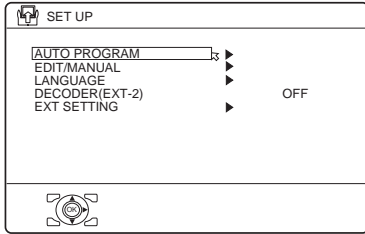

www.DataSheet4U.com

## AUTO PROGRAM

You can again perform the AUTO PROGRAM function TV channel automatic registration which was performed in the “Initial settings” (page 7).

### 1 Choose AUTO PROGRAM, then press the OK or ► button

The COUNTRY menu appears as a sub-menu of the AUTO PROGRAM function. There are two COUNTRY menus. Pressing the yellow button changes the COUNTRY menu as follows:

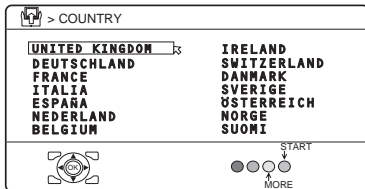

00003-EN

### 2 Press the ◀/▶ and ▼/▲ buttons to choose the country where you are

### 3 Perform steps 5 and 6 of the “Initial settings” (page 8)

## EDIT/MANUAL

The EDIT/MANUAL functions are divided into two types:

- editing the current programme numbers (PR) (EDIT functions); and
- manually storing a TV channel you want to view on a particular programme number (PR) (MANUAL function).

Here are the details about these functions:

### MOVE:

This function changes the programme number (PR) of a TV channel.

### ID:

This function registers a channel name (ID) to a TV channel.

### INSERT:

This function adds a new TV channel in the current programme numbers (PR) list by using the CH/CC number.

- You cannot use the INSERT function if you do not know the channel number of a TV channel. Use the MANUAL function to register a TV channel in the programme number (PR).

### DELETE:

This function deletes a TV channel you do not want to list.

### MANUAL:

This function manually stores a new TV channel in a programme number (PR).

## Caution

- Using the MOVE, DELETE or INSERT functions rewrites the current programme numbers (PR) list. Therefore, the programme numbers (PR) of some of the TV channels will change.
- Using the MANUAL function for a TV channel for which the CHILD LOCK function has been set cancels the CHILD LOCK function for that channel.

- Using the MANUAL function for a TV channel for which the DECODER (EXT-2) function has been set to ON returns the setting of the DECODER (EXT-2) function for that channel to OFF.
- When a TV channel has already been registered in PR 99, using the INSERT function deletes that TV channel.

■ Basic operation

1 Choose EDIT/MANUAL, then press the OK or ► button

The EDIT menu appears.

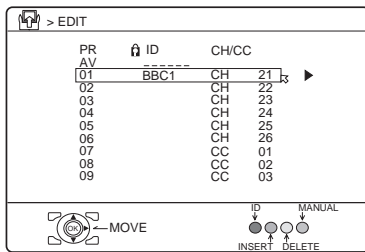

D0038-EN

2 Follow the description for the function you want to use

3 Press the OK button to complete the settings

The T-V LINK menu appears.

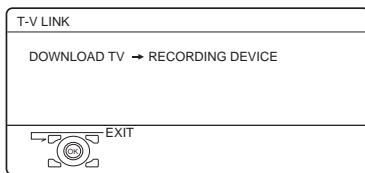

D0005-EN

**If you do not have a T-V LINK compatible VCR connected:**

Press the TV button to exit the T-V LINK menu.

The T-V LINK menu disappears.

**If you have a T-V LINK compatible VCR connected to the EXT-2 terminal:**

Follow “Downloading the data to VCR” on page 10 to transmit the programme number (PR) data.

- For programme number PR 0, “AV” appears in the programme numbers (PR) list.
- An EXT terminal number does not appear in the programme numbers (PR) list.

■ MOVE

1 Press the ▼/▲ buttons to choose a TV channel

2 Press the ► button to start the MOVE function

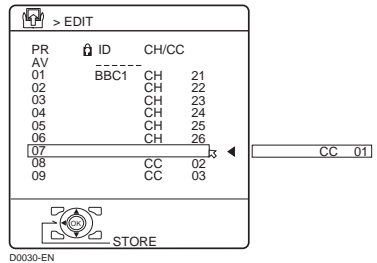

D0030-EN

3 Press the ▼/▲ buttons to choose a new programme number (PR)

To cancel the MOVE function:  
Press the BACK button.

4 Press the ◀ button to change the programme number (PR) of a TV channel to a new programme number (PR)

■ DELETE

1 Press the ▼/▲ buttons to choose a TV channel

2 Press the yellow button to delete the TV channel

The TV channel is deleted from the programme numbers (PR) list.

**■ ID**

**1 Press the ▼/▲ buttons to choose a TV channel**

**2 Press the red button to start the ID function**

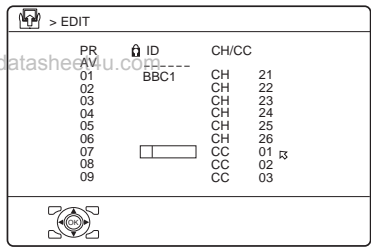

**3 Press the ▼/▲ buttons to choose a character**

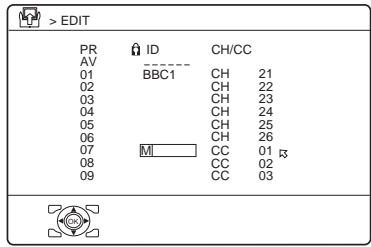

**4 Press the ◀/▶ buttons to move the cursor**

**5 Repeat steps 3 and 4 to complete the channel name**

**6 Press the OK button to give a channel name (ID) to a TV channel**

**Before performing INSERT or MANUAL operation**

- If you register the TV channel (SECAM-L system) from a French station, be sure to set the COUNTRY setting to FRANCE. If the COUNTRY setting is not set to FRANCE, perform steps 1 and 2 of the “AUTO PROGRAM” (page 32) procedure and set the COUNTRY setting to FRANCE before pressing the **OK** button.
- A CH/CC number unique to this TV and corresponding to the Channel number of a TV channel is required. Find the corresponding CH/CC number from a table “CH/CC numbers” on page 44 based on the Channel number of the TV channel.
- When the COUNTRY setting is not FRANCE, use a two-digit CH/CC number. When the COUNTRY setting is FRANCE, use a three-digit CH/CC number.

**■ INSERT**

- 1 Press the **▼/▲** buttons to choose a programme number (PR) for which you will register a new TV channel
- 2 Press the green button and start the INSERT function

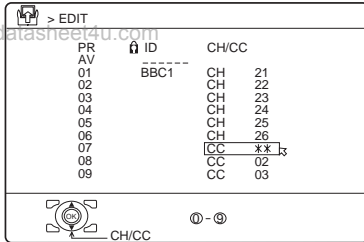

**To cancel the INSERT function:**  
Press the **BACK** button.

- 3 Press the **▼/▲** buttons to choose “CH” or “CC”, then enter the remaining CH or CC number  
**When the COUNTRY setting is FRANCE:**  
Choose “CH1”, “CH2”, “CC1” or “CC2”.

The TV shifts to registration mode.  
When the registration is completed, the picture of the TV channel appears on the screen.

- The CH/CC number is a number given to each broadcast frequency that carries a TV channel. If the TV cannot detect the TV channel corresponding to the broadcast frequency indicated by the CH/CC number, a “no-signal” picture appears.

**■ MANUAL**

- 1 Press the **▼/▲** buttons to choose a programme number (PR) for a new TV channel
- 2 Press the blue button to activate the MANUAL function

At the right side following the CH/CC number, the SYSTEM (broadcasting system) of the TV channel appears.

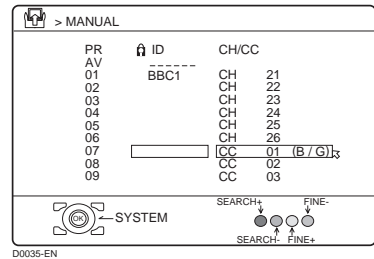

**To cancel the MANUAL function:**  
Press the **BACK** button.

- 3 Press the **▶** button to choose the **SYSTEM (broadcasting system)** for a TV channel you want to register  
**TV channel (SECAM-L system) from a French station:**

Set the SYSTEM to “L”. If it is set to one other than “L”, you cannot receive the TV channel of the SECAM-L system.

**Other TV channels:**

If you do not know the correct broadcasting system, set the SYSTEM to “B/G”. If “B/G” is not correct, you will not hear the sound normally when the TV detects a TV channel. In this case, retry to set the SYSTEM correctly so that no problem arises.

**4 Press the green or red button to search for a TV channel**

Scanning stops when the TV finds a TV channel. Then the TV channel is displayed.

**5 Press the green or red button repeatedly until the TV channel you want appears**

**If the TV channel reception is poor:**  
Press the blue or yellow button to fine-tune the TV channel.

**6 Press the OK button and register the TV channel to a Programme number (PR)**

The normal EDIT menu is resumed.

**LANGUAGE**

The LANGUAGE setting which was performed in the “Initial settings” (page 7) can be changed.

**1 Choose LANGUAGE, then press the OK or ► button**

A sub-menu of the LANGUAGE function appears.

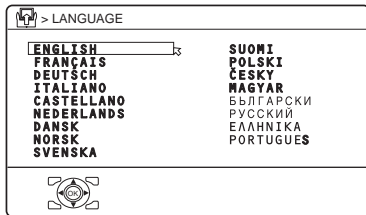

**2 Press the ◀/▶ and ▼/▲ buttons to choose a language. Then press the OK button**

**DECODER (EXT-2)**

If you have a decoder connected to a T-V LINK compatible VCR, which in turn is connected to the EXT-2 terminal, use the DECODER (EXT-2) function to unscramble the scrambled TV channels.

**1 Turn on the decoder power**

**2 Display the scrambled TV channel on the TV**

Even if the decoder is working, a scrambled picture appears.

**3 Display the SET UP menu and choose DECODER (EXT-2)**

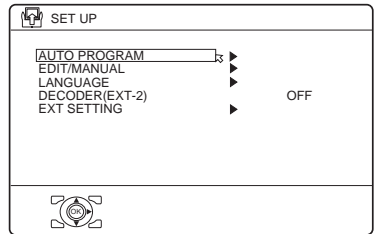

**4 Press the ◀/▶ buttons to choose ON**

An unscrambled picture appears.

**To cancel the DECODER (EXT-2) function:**

Press the ◀/▶ buttons to choose OFF.

**5 Press the OK button to complete the setting**

The T-V LINK menu appears.

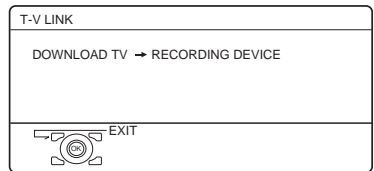

You can send the programme numbers data to a VCR with the T-V LINK function.

## 6 Turn on the VCR, and then press the OK button to transmit the data to VCR

The T-V LINK menu disappears once the data transmission ends.

If the DECODER (EXT-2) function has been set to "ON" but the TV channel cannot be unscrambled, check the following:

- Has the decoder been connected to the VCR properly according to the VCR and decoder instruction manuals?
- Has the decoder power been turned on?
- Can the TV channel be unscrambled with a decoder?
- Do you need to change the VCR settings in order to connect the decoder? Confirm that the VCR is set properly by rechecking the VCR instruction manual.

## EXT SETTING

### 1 Choose EXT SETTING, then press the OK or ► button

The EXT SETTING menu appears.

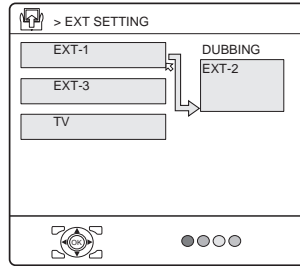

### 2 Follow the instructions for the function you want to use and operate the function

#### S-IN:

You can enjoy the high-quality picture of the S-VIDEO signal (Y/C signal).

#### DUBBING:

You can choose a signal source to be output from an EXT-2 terminal.

### ■ S-IN (S-VIDEO input)

You can connect a device (such as an S-VHS VCR) to enjoy the high-quality picture of the S-VIDEO signal (Y/C signal).

#### Preparation:

- First read the device's instruction manual and "Additional preparation" on page 40 to connect the device to the TV properly. Second, follow the device's instruction manual to set the device so that it sends an S-VIDEO signal (Y/C signal) to the TV.
- Do not set S-IN (S-VIDEO input) to an EXT terminal connected to a device which cannot output an S-VIDEO (Y/C signal).

**1 Press the ◀/▶ or ▼/▲ buttons to choose an EXT terminal**

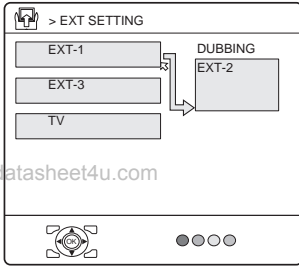

www.datasheet4u.com

- Setting S-IN (S-VIDEO input) changes the head character from “E” to “S”. When an EXT terminal receives a normal video signal, “E2” appears on the display. This changes to “S2” when it receives an S-VIDEO signal.
- Even a device which can output an S-VIDEO signal (Y/C signal) may output a regular video signal (composite signal) depending on the device setting. If a picture cannot appear because the S-IN (S-VIDEO input) setting has been made, read the device instruction manual carefully again to check for the device settings.

**■ DUBBING**

You can choose a signal source to be output from the EXT-2 terminal.

You can do this with the output signals of the devices connected to other EXT terminals, or with the picture and sound from a TV channel you are currently viewing.

**1 Press the ◀/▶ buttons to choose the arrow from the menu**

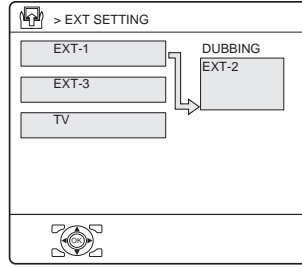

D0022-EN

**2 Press the ▼/▲ buttons to choose an EXT terminal or TV. Then press the OK button**

The arrow in the menu represents a signal flow. The left side of the arrow shows a signal source output from the EXT-2 terminal.

**EXT-1/EXT-3:**

The output signal of the device connected to an EXT terminal passes through the TV and is output from the EXT-2 terminal.

**TV:**

The picture and sound of the TV channel you are currently viewing are output from the EXT-2 terminal.



- 
- During dubbing, you cannot turn off the TV. Turning off the TV also turns off the output from the EXT-2 terminal.
  - When you choose an EXT terminal as an output, you can view a TV programme or a picture from the other EXT terminal while dubbing the picture from a device connected to the EXT terminal onto a VCR connected to the EXT-2 terminal.
  - The RGB signals from TV games cannot be output. Teletext programmes cannot be output.
- 

www.datasheet4u.com

# Additional preparation

---

## Connecting external equipment

---

Connect the equipment to the TV, making the correct rear panel and front panel connections.

### Before connecting anything:

- Read the manuals that came with the equipment.  
Depending on the equipment, the connection method may be different from the diagram. Also, the equipment settings may need to change depending on the connection method.
- Turn off all the equipment including the TV.
- The “Specifications” on page 50 give the details of the EXT terminals. If you are connecting equipment not listed in the following connection diagram, see the table to choose the best EXT terminal.
- Connecting cables are not supplied.

- ① VCR (composite signal)
- ② VCR (composite signal/S-VIDEO signal)
- ③ T-V LINK compatible VCR (composite signal/S-VIDEO signal)
- ④ Decoder
- ⑤ DVD player (composite signal/S-VIDEO signal)
- ⑥ DVD player (composite signal/RGB signal)
- ⑦ DVD player (component video signals; Y/Pb/Pr)
- ⑧ DVD player (digital video signals)
- ⑨ TV game (composite signal/RGB signal)
- ⑩ TV game (composite signal)
- ⑪ Headphones
- ⑫ Camcorder (composite signal)
- ⑬ Computer (analogue RGB signal)
- ⑭ SCART cable
- ⑮ Audio cable
- ⑯ Video cable
- ⑰ Component cable
- ⑱ DVI-HDMI converter cable
- ⑲ DVI cable
- ⑳ “DVI-I”-“D-SUB” converter cable

without terminal covers

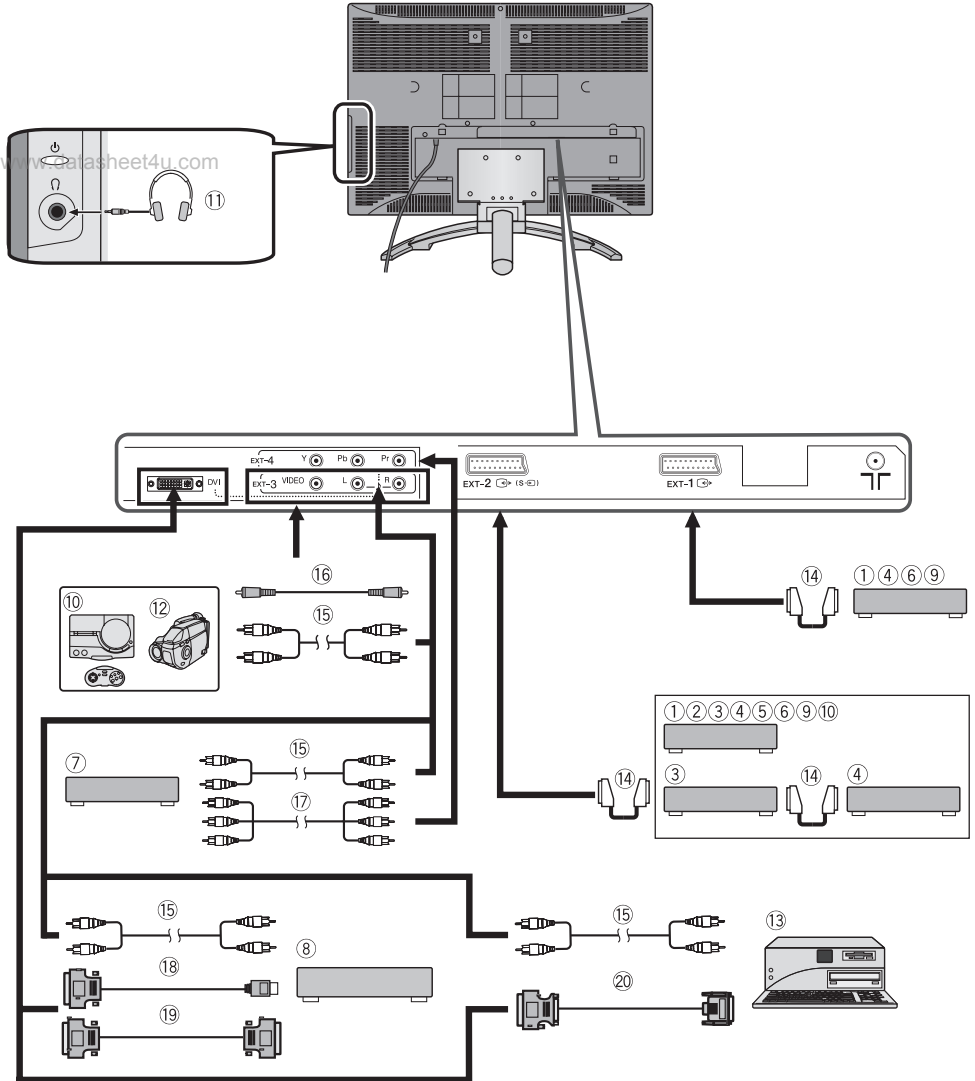

■ **Equipment which can output the S-VIDEO signal (Y/C signal) such as an S-VHS VCR**

Connect the equipment to an EXT-2 terminal. You can choose between an S-VIDEO signal (Y/C signal) and a regular video signal (composite signal). For details of how to operate the equipment, see “S-IN (S-VIDEO input)” on page 37.

■ **T-V LINK compatible VCR**

Be sure to connect the T-V LINK compatible VCR to the EXT-2 terminal. If not, the T-V LINK function will not work properly.

- When connecting a T-V LINK compatible VCR to the EXT-2 terminal, be sure to connect the decoder to the VCR. If not, the T-V LINK function may not work properly.
- When you connect the decoder to the VCR, after you have stored TV channels in the programme numbers (PR) list, set the DECODER (EXT-2) function for the programme number (PR) to ON to unscramble a scrambled TV channel. For details, see “DECODER (EXT-2)” on page 36.

■ **Connecting headphones**

Connect the headphones with a stereo mini-jack (3.5 mm diameter) to the headphone socket at the TV rear panel.

- No sound comes from the TV speakers when the headphones are connected.

■ **Video or sound signal output from the EXT-2 terminal**

You can change over the output of the video/sound signal from the EXT-2 terminal. This is useful when you want to dub the video/sound from another device onto the VCR connected to the EXT-2 terminal. For details on how to do this, see “DUBBING” on page 38.

- The signals from EXT-4 and PC IN terminal cannot be output from EXT-2.

■ **TV output from the EXT-1 terminal**

The video/sound signal of a TV channel you are viewing is always output from the EXT-1 terminal.

- Changing over a programme number (PR) also changes over the TV output from the EXT-1 terminal.
- The video/sound signal from an EXT terminal cannot be output.
- Teletext programmes cannot be output.

■ **Connecting to the computer**

Connect the D-SUB cable with “DVI-I”-“D-SUB” convert adapter from the computer’s analogue RGB output terminal to the DVI terminal on the back of the TV.

If you want to listen to the sound from the computer, use an audio cable to connect the VIDEO-3 AUDIO L/R sound input terminal to the computer’s sound output terminal.

When the sound from the computer is mono, connect to the VIDEO-3 AUDIO L terminal. To watch images from a computer, start the computer and press the **AV** or **P**  $\vee/\wedge$  buttons to choose “PC”.

- 
- Refer to the computer’s manual for a detailed explanation of the connections at the computer side.
  - Ensure that the connectors are facing the correct way when connecting.
  - After connecting the D-SUB cable with “DVI-I”-“D-SUB” convert adapter, tighten the two screws to fix the connector in place.
  - Digital output with a DVI cable is not supported.
-

This TV is compatible with the following PC signals.

Resolution	Vertical frequency (Hz)	Horizontal frequency (kHz)
640 × 480 (VGA)	60.0	31.5
1024 × 768 (XGA)	60.0	42.0

- Only the above formats are supported.
- Even with the above formats and at 60 Hz, some problems may be experienced depending on the quality of the synchronous signal. (Depending on the quality, some pictures may not be displayed properly.)
- Apple Macintosh\* computers are not supported.

#### When a picture is not displayed

Check the computer's refresh rate and set it to 60 Hz. Refer to the computer's instruction manual. Computers which cannot have their refresh rate set 60 Hz cannot be used with this unit.

- \* Apple Macintosh is a registered trademark of Apple Computer, Inc.

#### ■ Connecting to the HDMI or DVI compatible device

Connect the HDMI-DVI converter cable from the HDMI terminal on the back of your HDMI compatible device to the DVI terminal on the back of the TV and audio cable from the audio output from HDMI compatible device to the VIDEO-3 AUDIO L/R terminal on the back of the TV.

To watch the images from a HDMI/DVI compatible device, press the **AV** or **P**  $\vee/\wedge$  buttons to choose "DVI".

- To connect the DVI compatible device to the DVI terminal, connect the DVI terminal of the DVI compatible device to the DVI terminal of the TV with the DVI cable.
- Ensure that the connectors are facing the correct way when connecting.
- After connecting the DVI-HDMI converter cable or DVI cable, tighten the two screws to fix the connector in place.
- Digital audio output from HDMI terminal is not supported.

The DVI of the TV is compatible with the following video signals.

VGA/60Hz	4:3
480i/60Hz (525i/60Hz)	4:3
480i/60Hz (525i/60Hz)	16:9
480p/60Hz (525p/60Hz)	16:9
576i/50Hz (625i/50Hz)	4:3
576i/50Hz (625i/50Hz)	16:9
576p/50Hz (625p/50Hz)	4:3
576p/50Hz (625p/50Hz)	16:9
720p/50Hz (750p/50Hz)	16:9
720p/60Hz (750p/60Hz)	16:9
1080i/50Hz (1125i/50Hz)	16:9
1080i/60Hz (1125i/60Hz)	16:9

# CH/CC numbers

When you want to use the INSERT function on page 35, find the CH/CC number corresponding to the Channel number of the TV channel from this table.

CH	Channel	CH	Channel	CC	Channel	CC	Channel
CH 02 / CH 202	E2, R1	CH 40 / CH 240	E40, R40	CC 01 / CC 201	S1	CC 31 / CC 231	S31
CH 03 / CH 203	E3, ITALY A	CH 41 / CH 241	E41, R41	CC 02 / CC 202	S2	CC 32 / CC 232	S32
CH 04 / CH 204	E4, ITALY B, R2	CH 42 / CH 242	E42, R42	CC 03 / CC 203	S3	CC 33 / CC 233	S33
CH 05 / CH 205	E5, ITALY D, R6	CH 43 / CH 243	E43, R43	CC 04 / CC 204	S4	CC 34 / CC 234	S34
CH 06 / CH 206	E6, ITALY E, R7	CH 44 / CH 244	E44, R44	CC 05 / CC 205	S5	CC 35 / CC 235	S35
CH 07 / CH 207	E7, ITALY F, R8	CH 45 / CH 245	E45, R45	CC 06 / CC 206	S6	CC 36 / CC 236	S36
CH 08 / CH 208	E8, R9	CH 46 / CH 246	E46, R46	CC 07 / CC 207	S7	CC 37 / CC 237	S37
CH 09 / CH 209	E9, ITALY G	CH 47 / CH 247	E47, R47	CC 08 / CC 208	S8	CC 38 / CC 238	S38
CH 10 / CH 210	E10, ITALY H, R10	CH 48 / CH 248	E48, R48	CC 09 / CC 209	S9	CC 39 / CC 239	S39
CH 11 / CH 211	E11, ITALY H+1, R11	CH 49 / CH 249	E49, R49	CC 10 / CC 210	S10	CC 40 / CC 240	S40
CH 12 / CH 212	E12, ITALY H+2, R12	CH 50 / CH 250	E50, R50	CC 11 / CC 211	S11	CC 41 / CC 241	S41
CH 21 / CH 221	E21, R21	CH 51 / CH 251	E51, R51	CC 12 / CC 212	S12	CC 75 / CC 275	X
CH 22 / CH 222	E22, R22	CH 52 / CH 252	E52, R52	CC 13 / CC 213	S13	CC 76 / CC 276	Y, R3
CH 23 / CH 223	E23, R23	CH 53 / CH 253	E53, R53	CC 14 / CC 214	S14	CC 77 / CC 277	Z, ITALY C, R4
CH 24 / CH 224	E24, R24	CH 54 / CH 254	E54, R54	CC 15 / CC 215	S15	CC 78 / CC 278	Z+1, R5
CH 25 / CH 225	E25, R25	CH 55 / CH 255	E55, R55	CC 16 / CC 216	S16	CC 79 / CC 279	Z+2
CH 26 / CH 226	E26, R26	CH 56 / CH 256	E56, R56	CC 17 / CC 217	S17		
CH 27 / CH 227	E27, R27	CH 57 / CH 257	E57, R57	CC 18 / CC 218	S18		
CH 28 / CH 228	E28, R28	CH 58 / CH 258	E58, R58	CC 19 / CC 219	S19		
CH 29 / CH 229	E29, R29	CH 59 / CH 259	E59, R59	CC 20 / CC 220	S20		
CH 30 / CH 230	E30, R30	CH 60 / CH 260	E60, R60	CC 21 / CC 221	S21		
CH 31 / CH 231	E31, R31	CH 61 / CH 261	E61, R61	CC 22 / CC 222	S22		
CH 32 / CH 232	E32, R32	CH 62 / CH 262	E62, R62	CC 23 / CC 223	S23		
CH 33 / CH 233	E33, R33	CH 63 / CH 263	E63, R63	CC 24 / CC 224	S24		
CH 34 / CH 234	E34, R34	CH 64 / CH 264	E64, R64	CC 25 / CC 225	S25		
CH 35 / CH 235	E35, R35	CH 65 / CH 265	E65, R65	CC 26 / CC 226	S26		
CH 36 / CH 236	E36, R36	CH 66 / CH 266	E66, R66	CC 27 / CC 227	S27		
CH 37 / CH 237	E37, R37	CH 67 / CH 267	E67, R67	CC 28 / CC 228	S28		
CH 38 / CH 238	E38, R38	CH 68 / CH 268	E68, R68	CC 29 / CC 229	S29		
CH 39 / CH 239	E39, R39	CH 69 / CH 269	E69, R69	CC 30 / CC 230	S30		

CH	Channel	CH	Channel	CC	Frequency (MHz)	CC	Frequency (MHz)
CH 102	F2	CH 141	F41	CC 110	116 - 124	CC 152	391 - 399
CH 103	F3	CH 142	F42	CC 111	124 - 132	CC 153	399 - 407
CH 104	F4	CH 143	F43	CC 112	132 - 140	CC 154	407 - 415
CH 105	F5	CH 144	F44	CC 113	140 - 148	CC 155	415 - 423
CH 106	F6	CH 145	F45	CC 114	148 - 156	CC 156	423 - 431
CH 107	F7	CH 146	F46	CC 115	156 - 164	CC 157	431 - 439
CH 108	F8	CH 147	F47	CC 116	164 - 172	CC 158	439 - 447
CH 109	F9	CH 148	F48	CC 123	220 - 228	CC 159	447 - 455
CH 110	F10	CH 149	F49	CC 124	228 - 236	CC 160	455 - 463
CH 121	F21	CH 150	F50	CC 125	236 - 244	CC 161	463 - 469
CH 122	F22	CH 151	F51	CC 126	244 - 252		
CH 123	F23	CH 152	F52	CC 127	252 - 260		
CH 124	F24	CH 153	F53	CC 128	260 - 268		
CH 125	F25	CH 154	F54	CC 129	268 - 276		
CH 126	F26	CH 155	F55	CC 130	276 - 284		
CH 127	F27	CH 156	F56	CC 131	284 - 292		
CH 128	F28	CH 157	F57	CC 132	292 - 300		
CH 129	F29	CH 158	F58	CC 133	300 - 306		
CH 130	F30	CH 159	F59	CC 141	306 - 311		
CH 131	F31	CH 160	F60	CC 142	311 - 319		
CH 132	F32	CH 161	F61	CC 143	319 - 327		
CH 133	F33	CH 162	F62	CC 144	327 - 335		
CH 134	F34	CH 163	F63	CC 145	335 - 343		
CH 135	F35	CH 164	F64	CC 146	343 - 351		
CH 136	F36	CH 165	F65	CC 147	351 - 359		
CH 137	F37	CH 166	F66	CC 148	359 - 367		
CH 138	F38	CH 167	F67	CC 149	367 - 375		
CH 139	F39	CH 168	F68	CC 150	375 - 383		
CH 140	F40	CH 169	F69	CC 151	383 - 391		

- 
- When two CH/CC numbers correspond to one Channel number, choose either one according to the current COUNTRY setting. When the COUNTRY setting is other than FRANCE, choose a two-digit CH/CC number. When the COUNTRY setting is FRANCE, choose a three-digit CH/CC number.
  - Find the CH/CC number (CC110 to CC161) corresponding to the TV channel (SECAM-L system) from a French cable TV station, based on the broadcast frequency of the TV channel. When you do not know the broadcast frequency, please contact the cable TV station.
  - The CH/CC numbers of CH102-CH169 and CC110-CC161 correspond to the TV channels being broadcast by a SECAM-L system. The other CH/CC numbers correspond to the TV channels being broadcast by a method other than a SECAM-L system.
-

# Troubleshooting

---

If a problem arises while you are using the TV, please read this troubleshooting guide carefully before you ask to have the TV repaired. You may be able to fix it easily by yourself. For example, if the mains plug is disconnected from the mains outlet, or the TV aerial has problems, you may think there is a problem with the TV itself.

## Important:

- This troubleshooting guide only covers problems whose causes are not easy to decide. If you have a question when you are operating a function, read the page(s) for that function carefully, not this troubleshooting guide.
- If you follow the advice in this troubleshooting guide without any success, unplug the mains plug and ask for your TV to be repaired. Do not attempt to repair the TV by yourself or to remove the rear cover of the TV.

## ■ If you cannot turn on the TV

- Is the mains plug connected to the mains outlet?
- Is the power lamp lit? If not, press the  $\odot$  button on the TV.
- Make sure you set the VCR/TV/DVD switch to the TV position. You cannot turn the TV on when the VCR/TV/DVD switch is set to the VCR or DVD position.

## ■ If you cannot turn off the TV

- Make sure you set the VCR/TV/DVD switch to the TV position. You cannot turn the TV off when the VCR/TV/DVD switch is set to the VCR or DVD position.

## ■ No picture or no sound

- Have you chosen a TV channel with very poor reception? If so, the BLUE BACK function will be activated: the entire screen becomes blue, and the sound is muted. If you still want to view the TV channel, follow the description “BLUE BACK” on page 30 to change the BLUE BACK function setting to OFF.
- If the SYSTEM setting for a TV channel is incorrect, it may prevent the sound from being issued. Follow the description “EDIT/MANUAL” on page 32 to use the MANUAL function to try to change the SYSTEM setting.
- When you are using EXT-3, EXT-4 or DVI terminal, make sure the audio cable is connected to EXT-3 L/R terminal.

## ■ Poor picture

- If noise (snow) totally blocks out the picture, there may be a problem with the aerial or aerial cable. Check the following to try to solve the problem:
  - Have the TV and aerial been connected properly?
  - Has the aerial cable been damaged?
  - Is the aerial pointing in the right direction?
  - Is the aerial itself faulty?
- If the TV or aerial suffers interference from other equipment, stripes or noise may appear in the picture. Move any equipment such as an amplifier, personal computer, or a hair drier, that can cause interference away from your TV. Or try moving the TV. If the aerial suffers interference from a radio tower or high-voltage wire, please contact your local dealer.
- If the TV suffers interference from signals reflecting from mountains or buildings, double-pictures (ghosting) will occur. Try to change the aerial’s direction or replace it with one with better directionality.
- Are your COLOUR SYSTEM settings correct? Follow the description “COLOUR SYSTEM” on page 26 to try to solve the trouble.
- Have the COLOUR and BRIGHT settings been adjusted properly? Follow the description “BRIGHT-2” and “COLOUR” on page 25 to try to adjust them properly.



- Videotaping teletext is not recommended because it may not record correctly.
- When viewing images from commercially available video software products, or videos from videotapes which have been recorded improperly, the top of the image may be distorted. This is due to the condition of the video signal. There is nothing wrong with the TV.

www.d Since this TV is designed to make full use of the resolution of the original video source, the motion may appear unnatural when the video source is input with progressive-scanning component signals. If this occurs, change the output setting of the connected device to interlace-scanning component signal output. See the instructions that came with the device for more information.

■ **Poor sound**

- Have you adjusted BASS or TREBLE properly? If not, follow the description “BASS” or “TREBLE” on page 28.
- When TV channel reception is poor, it can be hard to hear stereo or bilingual sound. In this case, follow the description “STEREO / I • II” on page 28 to hear the sound more easily by changing it to a mono sound.

■ **If the TV does not respond to the remote control**

- Have the batteries of the remote control worn out? Follow the description “Putting the batteries into the remote control” on page 7 and replace them with new batteries.
- Have you attempted to use the remote control from the sides or rear of the TV or from more than seven metres away from the TV? Use the remote control in front of your TV or from less than seven metres away.
- When you are viewing a teletext programme, you cannot operate the menus. Press the **TV** button to return to the ordinary TV programme, and then try operating the menus.
- If the TV suddenly stops responding, disconnect the power cord of the TV from the AC outlet. Connect them to the AC outlet again to turn on the TV. If the TV returns to a normal state, it is not a failure.

■ **Other issues**

- When the SLEEP TIMER function operates, the TV is automatically turned off. If the TV suddenly turns off, try to press the **⏻/I** (standby) button to turn on the TV once again. If the TV goes back to normal, there is no problem.
- When the TV is receiving a wide-screen signal (WSS) or a signal from an external device affecting the screen size, the ZOOM mode automatically changes. When you want to resume the previous ZOOM mode, press the **ZOOM** button again.
- It takes a short period of time from the time an operation such as changing channels is performed until an image is displayed. This is not a fault. This is the time needed for the image to stabilize before it can be displayed.
- The TV may make a crackling sound due to a sudden change in temperature. The picture or sound may be normal. If you hear crackling sounds frequently while you are viewing the TV, there may be other causes. As a precaution, ask your service technician to inspect it.

- The top of the TV and the screen may become hot during use but this has no affect on the performance of the TV. Make sure that the ventilation holes are not blocked.
- When the picture is unstable, the screen may become white for a moment. This happens when the signal which drives the liquid crystal is missing. This is not a fault.
- When a still image has been displayed for a long period, a faint residual image may remain on the screen for a short time after the power has been turned off or when another image is displayed. This is not a fault and the image will eventually disappear.

www.dataSheet4u.com

# Cable management

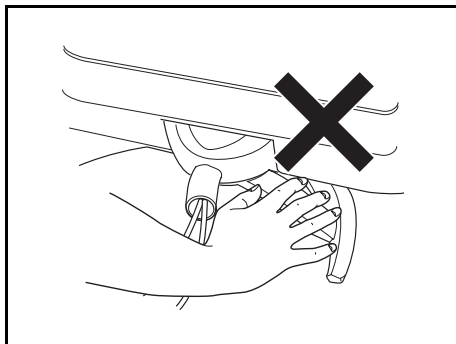
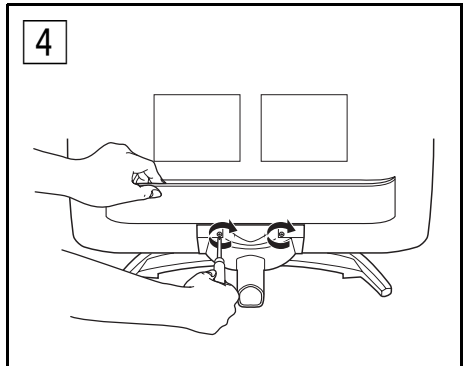
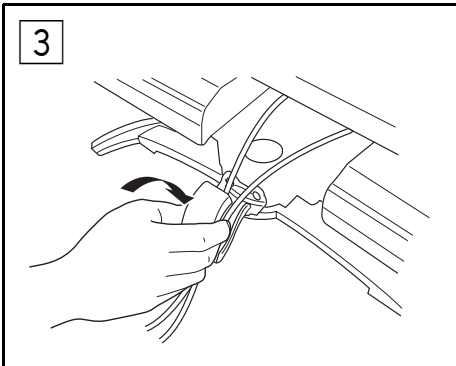
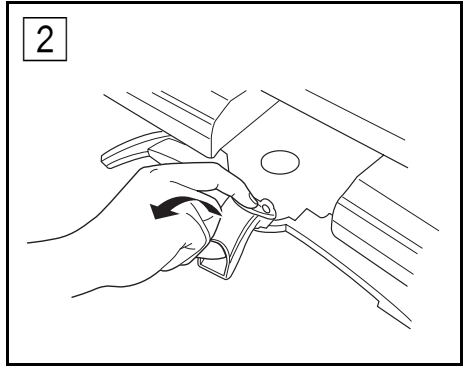
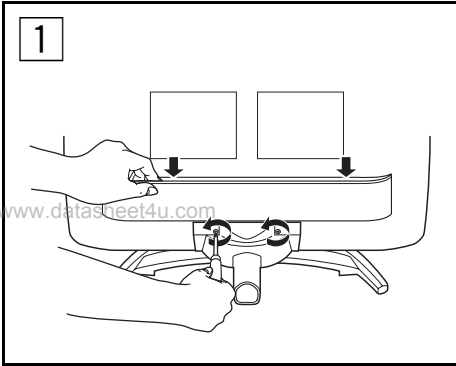

# Specifications

Model	LT-32A61BU/LT-32A61SU	LT-26A61BU/LT-26A61SU
Broadcasting systems	CCIR B/G, I, D/K, L	
Colour systems	PAL, SECAM • The EXT terminals also support the NTSC 3.58/4.43 MHz system.	
Channels and frequencies	F2-F10, F21-F69, 116-172, E2-E12, E21-E69, S1-S41, X, Y, Z, Z+1, Z+2, A-H, H+1, H+2, R1-R12, R21-R69 • French cable TV channel of broadcast frequencies 116 - 172 MHz and 220 - 469 MHz.	
Sound-multiplex systems	NICAM (B/G, I, D/K, L) system, A2 (B/G, D/K) system	
Teletext systems	FLOF (Fastext), TOP, WST (World Standard System)	
Power requirements	110 - 240 V AC, 50/60 Hz	
Screen size	Viewable area 80 cm (measured diagonally)	Viewable area 66 cm (measured diagonally)
Audio output	Rated Power output: 5 W + 5 W	
Speakers	6.6 cm round × 2	
EXT-1 terminal	Euroconnector (21-pin, SCART) • Video input, Audio L/R inputs and RGB inputs are available. • TV broadcast outputs (Video and Audio L/R) are available.	
EXT-2 terminal	Euroconnector (21-pin, SCART) • Video input, S-VIDEO (Y/C) input, Audio L/R inputs and RGB inputs are available. • Video and Audio L/R outputs are available. • T-V LINK functions are available.	
EXT-3 terminal	RCA connectors × 3 • Video input and Audio L/R inputs are available.	
EXT-4 terminal	RCA connectors × 3 + EXT-3 L/R • Component video (Y, Pb, Pr) input and Audio L/R inputs are available. • 625p, 525p, 750p and 1080i signals are available. 750p signal is only available for 60Hz. • Some DVD players can output 625p, 525p, 750p and 1080i signals. • 750p are new high-definition signals.	
DVI terminal	DVI terminal × 1 • Digital video input and PC signal is available. (Refer to page 41 for details).	
Headphone jack	Stereo mini-jack (3.5 mm in diameter)	
Dimensions (W × H × D)	820 mm × 602 mm × 269 mm 820 mm × 551 mm × 126.8 mm (without stand)	686 mm × 525 mm × 269 mm 686 mm × 474 mm × 121.5 mm (without stand)
Weight	18.1 kg 15.5 kg (without stand)	14.9 kg 12.3 kg (without stand)
Accessories	Remote control unit × 1 (RM-C1816S) AA/R6 dry cell battery × 2	

## We may change the design and specifications without notice.

Pictures displayed on the screen using this TV's ZOOM functions should not be shown for any commercial or demonstration purpose in public places (cafes, hotels, etc.) without the consent of the owners of copyright of the original picture sources, as this would be an infringement of copyright.



[www.datasheet4u.com](http://www.datasheet4u.com)

**JVC**

LT-32A61BU/LT-32A61SU/LT-26A61BU/LT-26A61SU

**JVC**