

High Performance Switched Capacitor Universal Filter

FEATURES

- All Filter Parameters *Guaranteed* over Temperature
- Wide Center Frequency Range (0.1Hz to 40kHz)
- Low Noise Wide Dynamic Range
- *Guaranteed* Operation for $\pm 2.37V$ and $\pm 5V$ Supply
- Low Power Consumption
- *Guaranteed* Clock to Center Frequency Accuracy of 0.3% (LTC1059A)
- *Guaranteed* Low Offset Voltages over Temperature
- Very Low Center Frequency and Q Tempco
- Clock Input T²L or CMOS Compatible
- Separate Highpass (or Notch or Allpass), Bandpass, Lowpass Outputs

APPLICATIONS

- Sinewave Oscillators
- Sweepable Bandpass/Notch Filters
- Full Audio Frequency Filters
- Tracking Filters

DESCRIPTION

The LTC1059 consists of a general purpose, high performance, active filter building block and an uncommitted op amp. The filter building block together with an external clock and 2 to 5 resistors can produce various second order functions which are available at its three output pins. Two out of three always provide lowpass and bandpass functions while the third output pin can produce notch or highpass or allpass. The center frequency of these functions can be tuned from 0.1Hz to 40kHz and it is dependent on an external clock or an external clock and a resistor ratio. The filter can handle input frequencies up to 100kHz. The uncommitted op amp can be used to obtain additional allpass and notch functions, for gain adjustment or for cascading techniques.

Higher than second order filter functions can be obtained by cascading the LTC1059 with the LTC1060 dual universal filter or LTC1061 triple universal filter. Any classical filter realization (such as Butterworth, Cauer, Bessel and Chebyshev) can be formed.

The LTC1059 can be operated with single or dual supplies ranging from $\pm 2.37V$ to $\pm 8V$ (or 4.74V to 16V single supply) and is pinout compatible with MF5.

The LTC1059 is manufactured by using Linear Technology's enhanced LTCMOS™ silicon gate process.

LTCMOS™ is a trademark of Linear Technology Corp.

7

TYPICAL APPLICATION

Wide Range 2nd Order Bandpass/Notch Filter with Q = 10

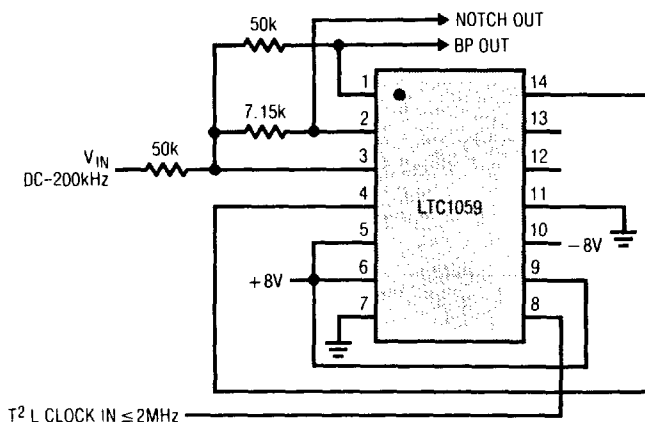

Center Frequency and Q Error

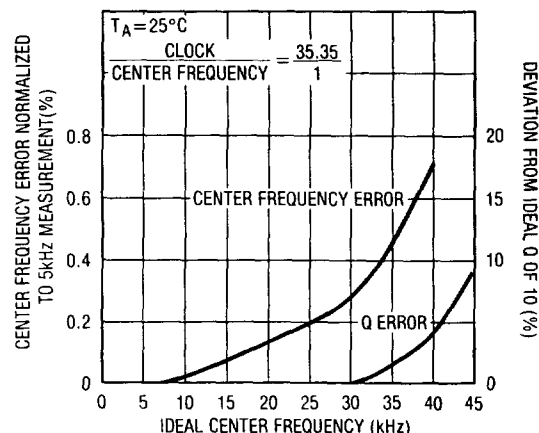

ABSOLUTE MAXIMUM RATINGS

Supply Voltage 18V
 Power Dissipation 500mW
 Operating Temperature Range
 LTC1059AC, LTC1059C $-40^{\circ}\text{C} \leq T_A \leq 85^{\circ}\text{C}$
 LTC1059AM, LTC1059M $-55^{\circ}\text{C} \leq T_A \leq 125^{\circ}\text{C}$
 Storage Temperature Range -65°C to 150°C
 Lead Temperature (Soldering, 10sec) 300°C

PACKAGE/ORDER INFORMATION

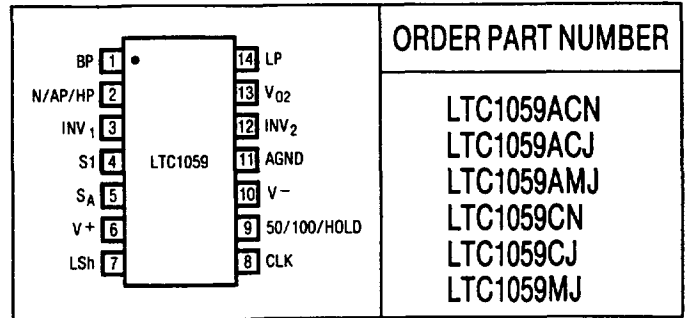

ELECTRICAL CHARACTERISTICS

(Complete Filter) $V_S = \pm 5V$, $T_A = 25^{\circ}\text{C}$, T^2L clock input level unless otherwise specified.

| PARAMETER | CONDITIONS | MIN | TYP | MAX | UNITS |
|---------------------------------|--|-----|--|-----------------|-------------------------|
| Center Frequency Range, f_o | $f_o \times Q \leq 400\text{kHz}$, Mode 1 $f_o \times Q \leq 1.6\text{MHz}$, Mode 1 $f_o \times Q \leq 250\text{kHz}$, Mode 3, $V_S = \pm 7.5V$ $f_o \times Q \leq 1\text{MHz}$, Mode 3, $V_S = \pm 7.5V$ | | 0.1-40k 0.1-18k 0.1-20k 0.1-16k | | Hz Hz Hz Hz |
| Input Frequency Range | | | 0-200k | | Hz |
| Clock to Center Frequency Ratio | | | | | |
| LTC1059A | Mode 1, 50:1, $f_{CLK} = 250\text{kHz}$, $Q = 10$ | ● | | $50 \pm 0.3\%$ | |
| LTC1059 | Mode 1, 50:1, $f_{CLK} = 250\text{kHz}$, $Q = 10$ | ● | | $50 \pm 0.8\%$ | |
| LTC1059A | Mode 1, 100:1, $f_{CLK} = 500\text{kHz}$, $Q = 10$ | ● | | $100 \pm 0.3\%$ | |
| LTC1059 | Mode 1, 100:1, $f_{CLK} = 500\text{kHz}$, $Q = 10$ | ● | | $100 \pm 0.8\%$ | |
| Q Accuracy | | | | | |
| LTC1059A | Mode 1, 50:1 or 100:1, $f_o = 5\text{kHz}$ | ● | ± 0.5 | 3 | % |
| LTC1059 | $Q = 10$ | ● | ± 0.5 | 5 | % |
| f_o Temperature Coefficient | Mode 1, $f_{CLK} < 500\text{kHz}$ | | 5 | | ppm/ $^{\circ}\text{C}$ |
| Q Temperature Coefficient | Mode 1, $f_{CLK} < 500\text{kHz}$, $Q = 10$ | | 15 | | ppm/ $^{\circ}\text{C}$ |
| DC Offset V_{OS1} | | ● | 2 | 15 | mV |
| V_{OS2} | $f_{CLK} = 250\text{kHz}$, 50:1, $S_{A/B}$ High | ● | 3 | 30 | mV |
| V_{OS2} | $f_{CLK} = 500\text{kHz}$, 100:1, $S_{A/B}$ High | ● | 6 | 60 | mV |
| V_{OS2} | $f_{CLK} = 250\text{kHz}$, 50:1, $S_{A/B}$ Low | ● | 2 | 20 | mV |
| V_{OS2} | $f_{CLK} = 500\text{kHz}$, 100:1, $S_{A/B}$ Low | ● | 4 | 40 | mV |
| V_{OS3} | $f_{CLK} = 250\text{kHz}$, 50:1 | ● | 2 | 20 | mV |
| V_{OS3} | $f_{CLK} = 500\text{kHz}$, 100:1 | ● | 4 | 40 | mV |
| DC Low Pass Gain Accuracy | Mode 1, $R1 = R2 = 50\text{k}\Omega$ | ● | ± 0.1 | 2 | % |
| BP Gain Accuracy at f_o | Mode 1, $Q = 10$, $f_o = 5\text{kHz}$ | | ± 0.1 | | % |
| Clock Feedthrough | $f_{CLK} \leq 1\text{MHz}$ | | 10 | | mV |
| Max. Clock Frequency | Mode 1, $Q < 5$, $V_S \geq \pm 5V$ | | 2 | | MHz |
| Power Supply Current | | ● | 3.5 | 5.5 7 | mA mA |

ELECTRICAL CHARACTERISTICS (Complete Filter) $V_S = \pm 2.37V$, $T_A = 25^\circ C$ unless otherwise specified

| PARAMETER | CONDITIONS | MIN | TYP | MAX | UNITS |
|---|--|-----|--------------------|-----------|----------|
| Center Frequency Range | $f_o \times Q \leq 120kHz$, Mode 1, 50:1 $f_o \times Q \leq 120kHz$, Mode 3, 50:1 | | 0.1-12k 0.1-10k | | Hz Hz |
| Input Frequency Range | | | 60k | | Hz |
| Clock to Center Frequency Ratio LTC1059A LTC1059 LTC1059A LTC1059 | Mode 1, 50:1, $f_{CLK} = 250kHz$, $Q = 10$ ● Mode 1, 50:1, $f_{CLK} = 250kHz$, $Q = 10$ Mode 1, 100:1, $f_{CLK} = 250kHz$, $Q = 10$ ● Mode 1, 100:1, $f_{CLK} = 250kHz$, $Q = 10$ | | | 50 ± 0.5% | |
| Q Accuracy LTC1059A LTC1059 | Mode 1, $f_{CLK} = 250kHz$, $Q = 10$ 50:1 and 100:1 | | ± 1 ± 2 | | % % |
| Max. Clock Frequency Power Supply Current | | | 700k 1.5 | 2.5 | Hz mA |

ELECTRICAL CHARACTERISTICS (Internal Op Amps) $T_A = 25^\circ C$ unless otherwise specified

| PARAMETER | CONDITIONS | MIN | TYP | MAX | UNITS |
|--|---|-----------------------|----------------------|-----|----------------------|
| Supply Voltage Range | | ± 2.375 | | ± 8 | V |
| Voltage Swings LTC1059A LTC1059 LTC1059, LTC1059A | $V_S = \pm 5V$, $R_L = 5k$ (Pins 1, 14) $R_L = 3.5k$ (Pins 2, 13) ● | ± 4 ± 3.8 ± 3.6 | ± 4.2 ± 4.2 | | V V V |
| Input Offset Voltage Input Bias Current Output Short Circuit Current Source/Sink DC Open Loop Gain | $V_S = \pm 5V$ ● | | 1 3 40/3 80 | 15 | mV pA mA dB |
| GBW Slew Rate | $V_S = \pm 5V$ $V_S = \pm 5V$ | | 2 7 | | MHz V/μs |

The ● denotes the specifications which apply over the full operating temperature range.

BLOCK DIAGRAM

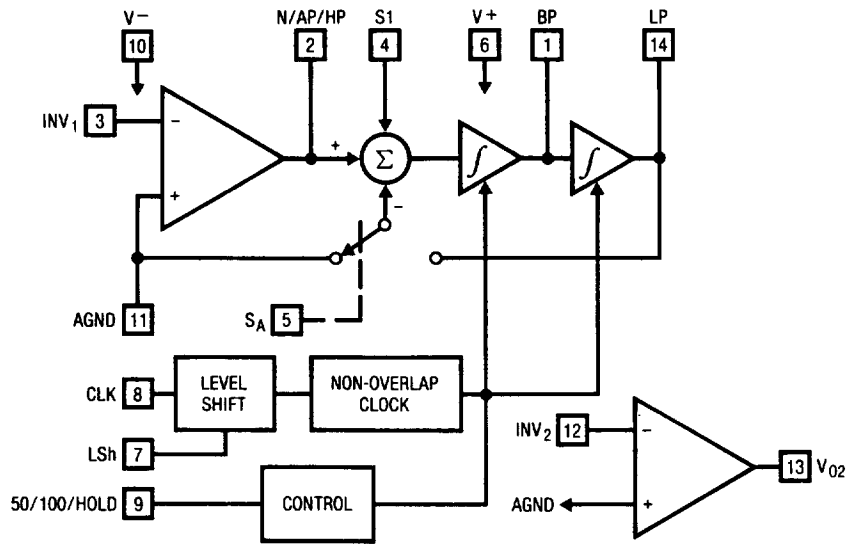

TYPICAL PERFORMANCE CHARACTERISTICS

Graph 1. Mode 1:
(f_{CLK}/f_o) Deviation vs Q

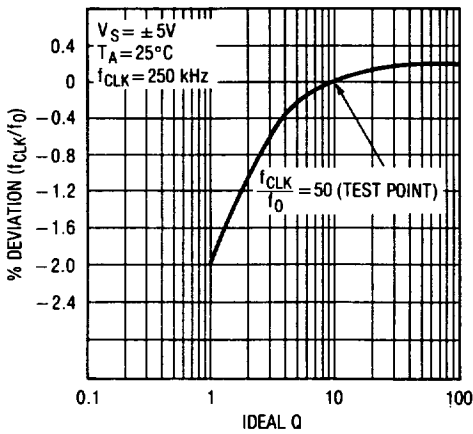

Graph 2. Mode 1:
(f_{CLK}/f_o) Deviation vs Q

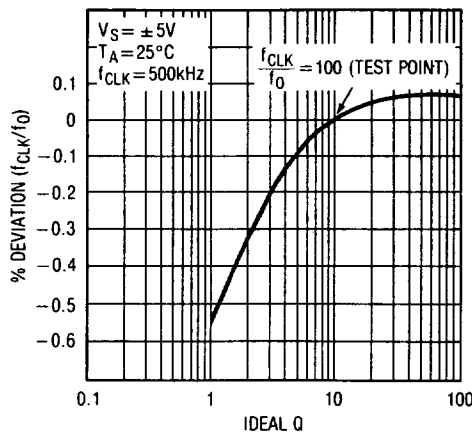

Graph 3. Mode 1: Q Error vs Clock Frequency

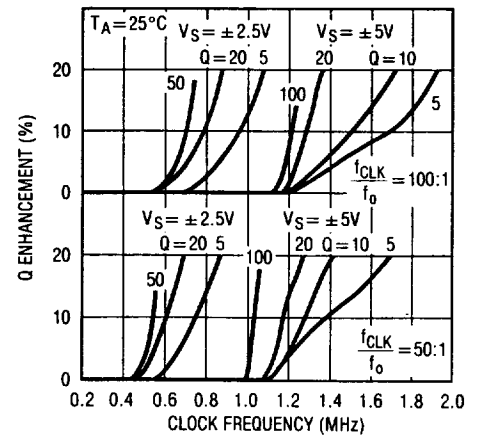

TYPICAL PERFORMANCE CHARACTERISTICS

Graph 4. Mode 1: Q Error vs Clock Frequency

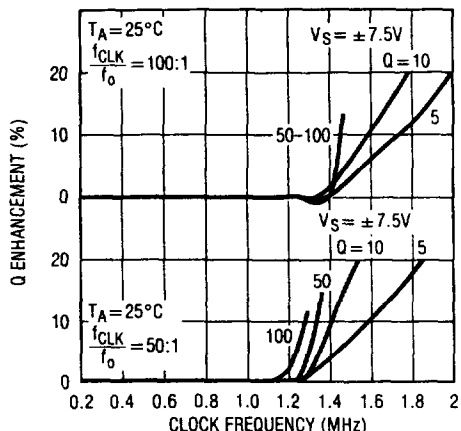

Graph 5. Mode 1: Measured Q vs f_{CLK} and Temperature

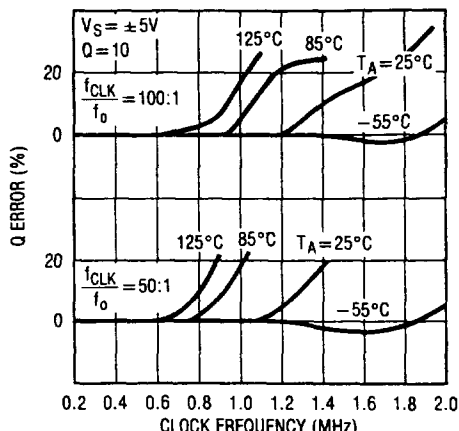

Graph 6. Mode 1: (f_{CLK}/f₀) vs f_{CLK} and Q

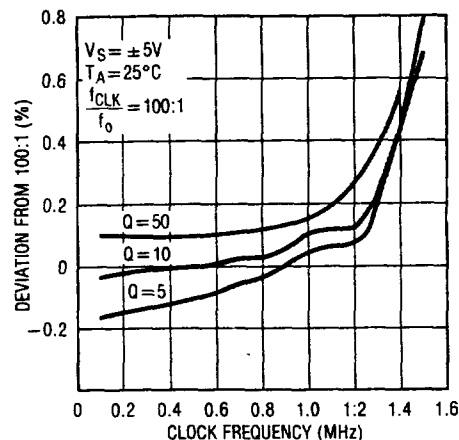

Graph 7. Mode 1: (f_{CLK}/f₀) vs f_{CLK} and Q

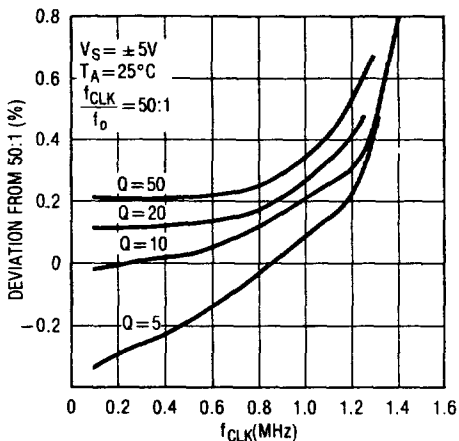

Graph 8. Mode 1: (f_{CLK}/f₀) vs f_{CLK} and Temperature

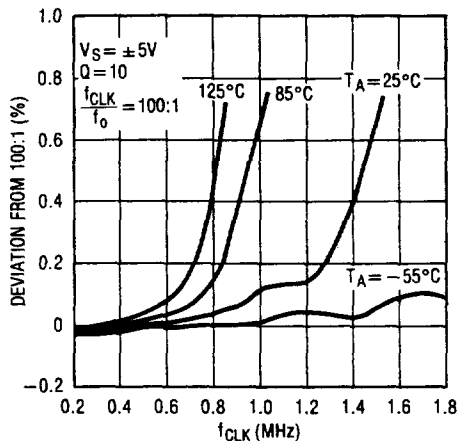

Graph 9. Mode 1: (f_{CLK}/f₀) vs f_{CLK} and Temperature

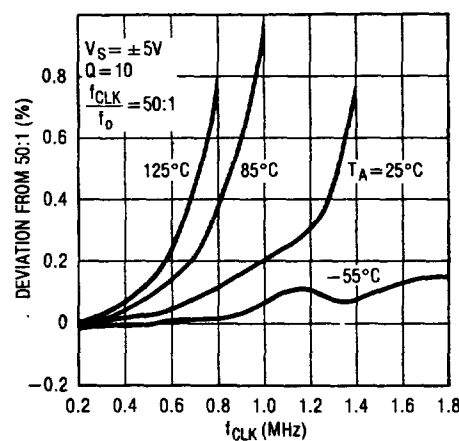

Graph 10. Mode 1: (f_{CLK}/f₀) vs f_{CLK} and Q

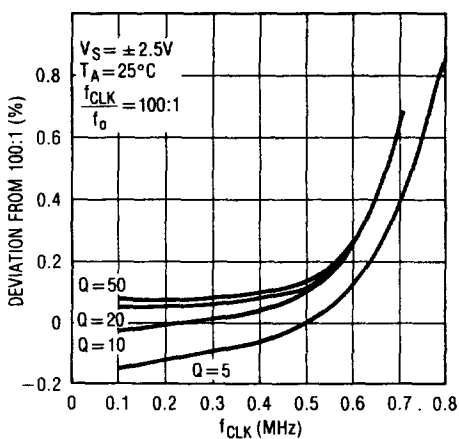

Graph 11. Mode 1: (f_{CLK}/f₀) vs f_{CLK} and Q

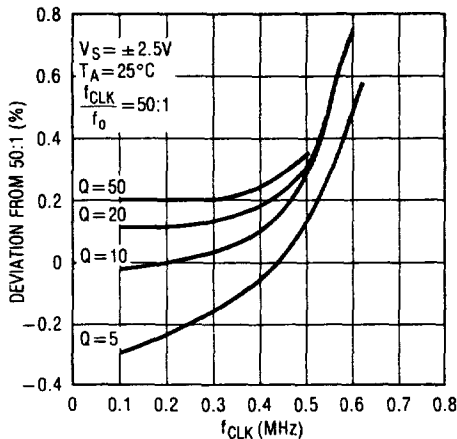

Graph 12. Mode 1: (f_{CLK}/f₀) vs f_{CLK} and Temperature

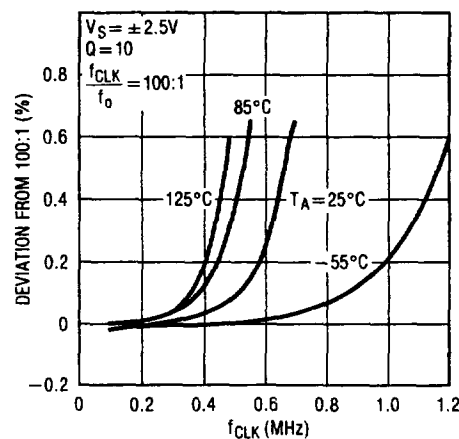

7

TYPICAL PERFORMANCE CHARACTERISTICS

Graph 13. Mode 1: (f_{CLK}/f_o) vs f_{CLK} and Temperature

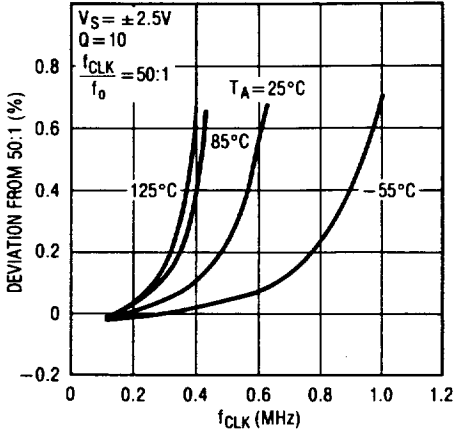

Graph 14. Mode 1: Notch Depth vs Clock Frequency

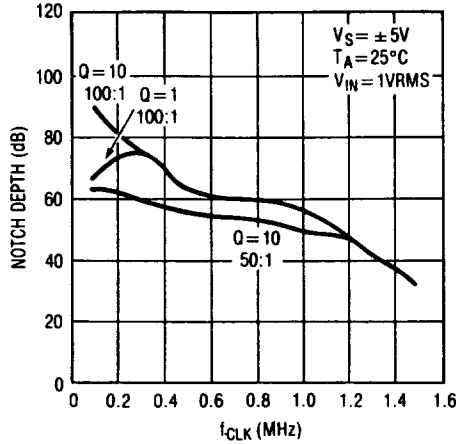

Graph 15. Mode 3: Deviation of (f_{CLK}/f_o) with Respect to Q = 10 Measurement

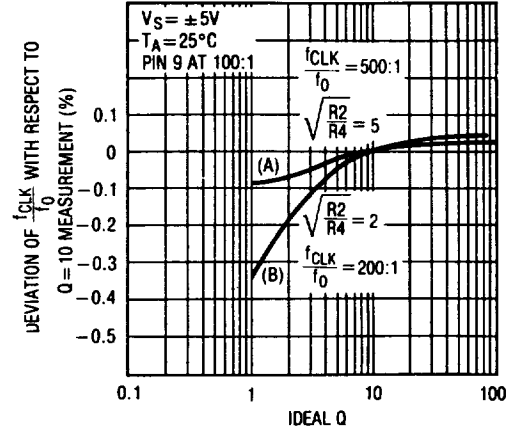

Graph 16. Mode 3: Q Error vs Clock Frequency

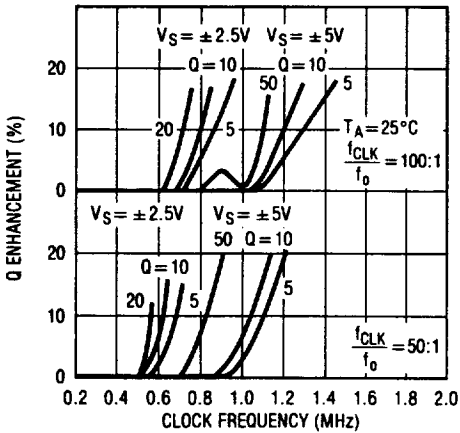

Graph 17. Mode 3 (R2 = R4): Q Error vs Clock Frequency

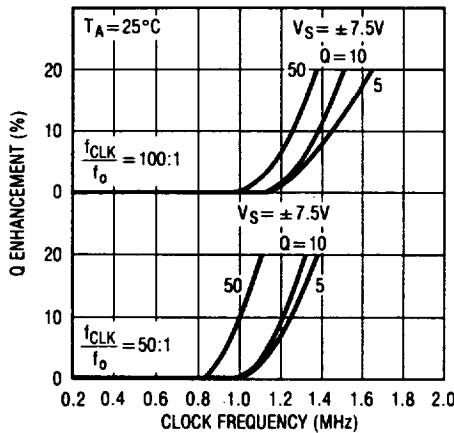

Graph 18. Mode 3 (R2 = R4): Measured Q vs f_{CLK} and Temperature

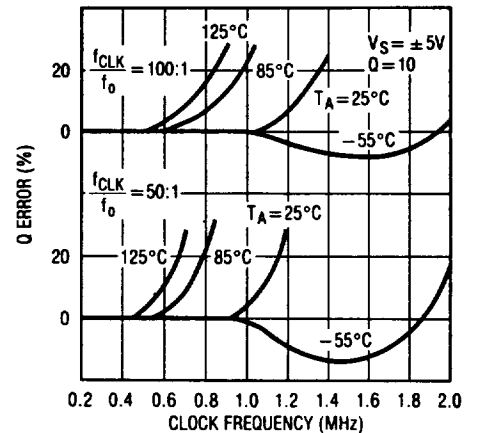

Graph 19. Mode 3 (R2 = R4): (f_{CLK}/f_o) vs f_{CLK} and Q

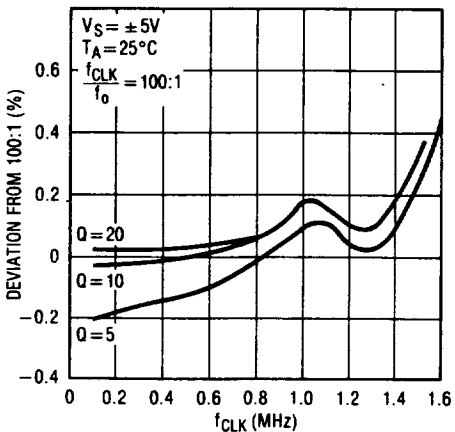

Graph 20. Mode 3 (R2 = R4): (f_{CLK}/f_o) vs f_{CLK} and Q

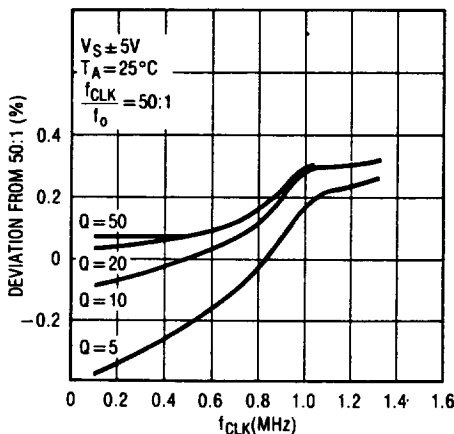

Graph 21. Mode 3 (R2 = R4): (f_{CLK}/f_o) vs f_{CLK} and Temperature

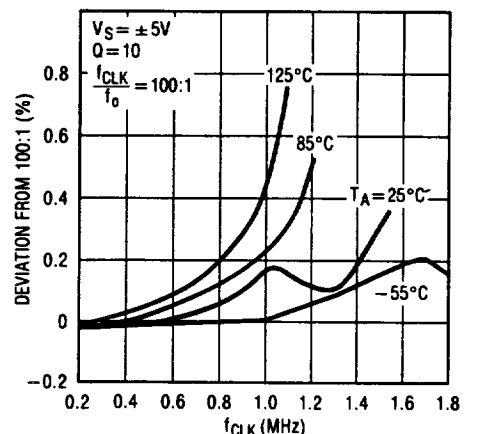

TYPICAL PERFORMANCE CHARACTERISTICS

Graph 22. Mode 3 (R2 = R4):
(f_{CLK}/f_o) vs f_{CLK} and Temperature

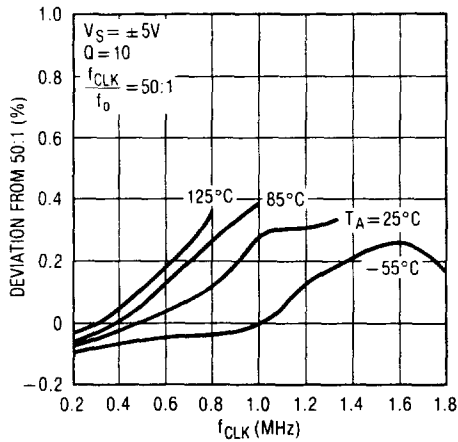

Graph 23. Mode 3 (R2 = R4):
(f_{CLK}/f_o) vs f_{CLK} and Temperature

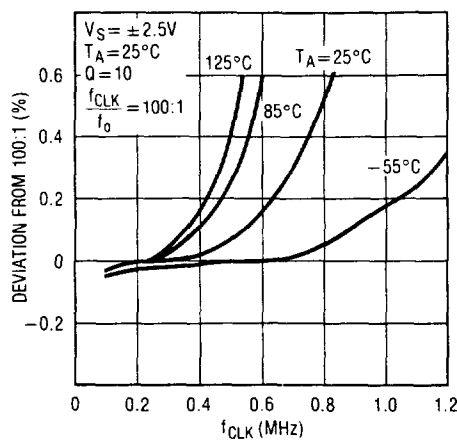

Graph 24. Mode 3 (R2 = R4):
(f_{CLK}/f_o) vs f_{CLK} and Temperature

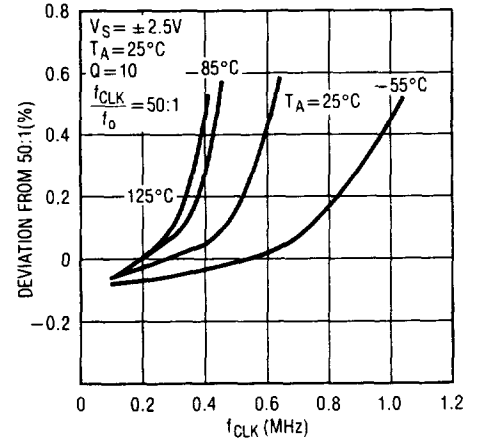

Graph 25. Mode 1c (R5 = 0),
Mode 2 (R2 = R4) Q Error vs Clock
Frequency

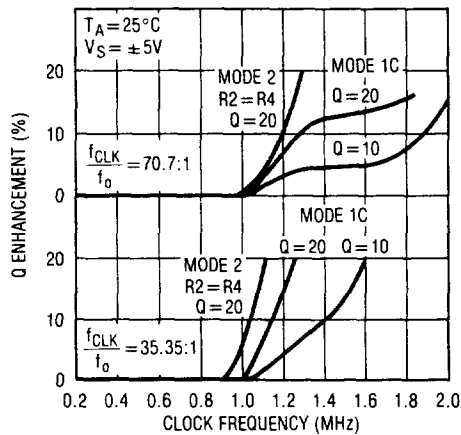

Graph 26. Supply Current vs
Supply Voltage

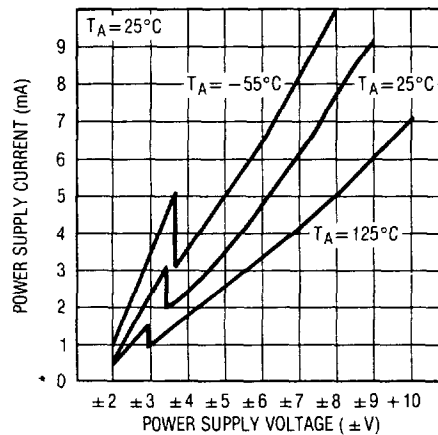

APPLICATIONS INFORMATION

The LTC1059 is compatible with the LTC1060. All the LTC1059 pins are functionally equivalent to the LTC1060 pins bearing the same title. For a detailed pin description and definition of various modes of operation refer to the LTC1060 data sheet. The LTC1059 is typically "faster" than the LTC1060 especially under single 5V (or ±2.5V)

supply operation. This becomes apparent through the typical performance characteristics of the part. All the graphs shown in this data sheet have been drawn under the same test conditions as in the LTC1060 data sheet; they are also numbered in the same order. For a complete discussion of the filter characteristics see the LTC1060 data sheet.

PACKAGE DESCRIPTION Dimensions in inches (millimeters) unless otherwise noted.

**J Package
14-Lead Ceramic DIP**

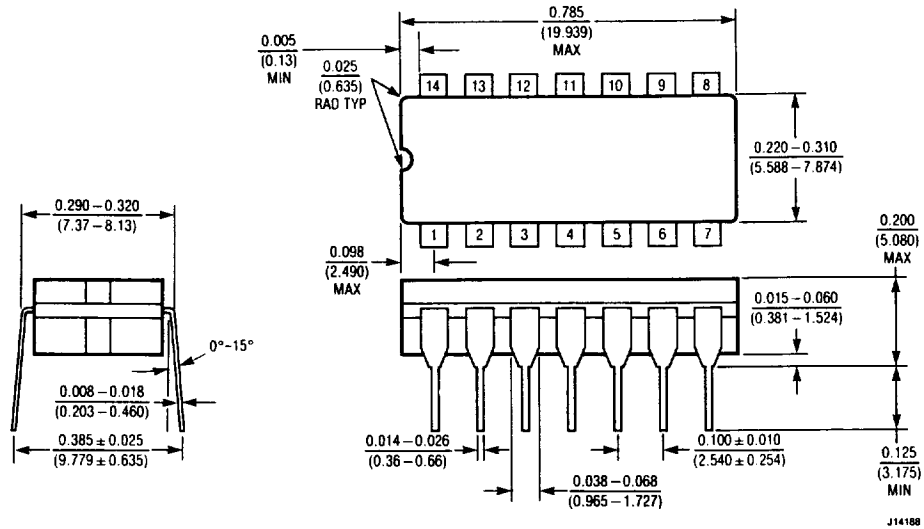

| | |
|---------------------|-------------------------|
| T_{jmax} 150°C | Θ_{ja} 80°C/W |
|---------------------|-------------------------|

**N Package
14-Lead Plastic DIP**

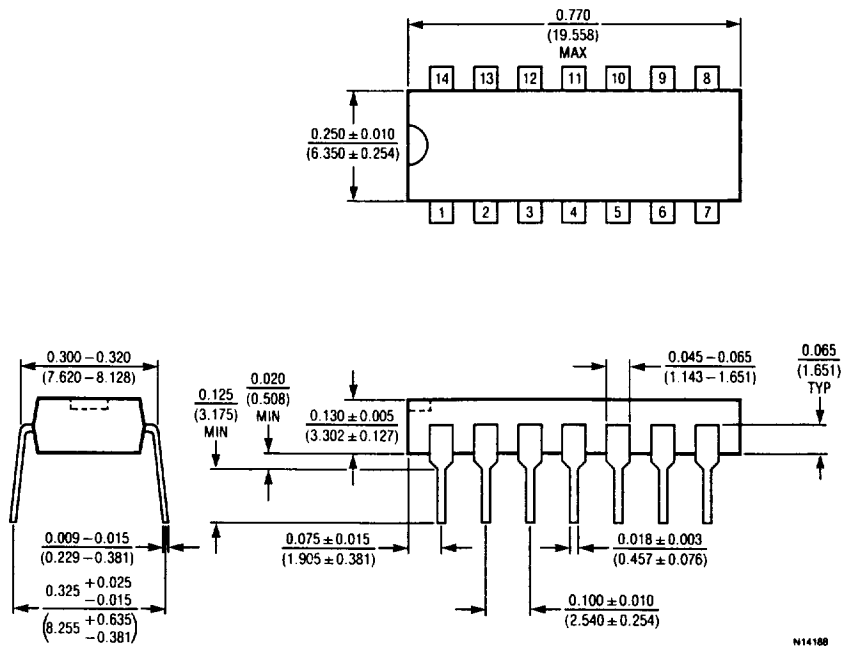

| | |
|---------------------|--------------------------|
| T_{jmax} 110°C | Θ_{ja} 130°C/W |
|---------------------|--------------------------|