

FEATURES

- Slew Rate: 50V/ μ s Typ
- Gain-Bandwidth Product: 23MHz Typ
- Fast Settling to 0.01%
 - 2V Step to 200 μ V: 250ns Typ
 - 10V Step to 1mV: 480ns Typ
- Excellent DC Precision in All Packages
 - Input Offset Voltage: 450 μ V Max
 - Input Offset Voltage Drift: 10 μ V/ $^{\circ}$ C Max
 - Input Offset Current: 120nA Max
 - Input Bias Current: 600nA Max
 - Open-Loop Gain: 1000V/mV Min
- Single Supply Operation
 - Input Voltage Range Includes Ground
 - Output Swings to Ground While Sinking Current
- Low Input Noise Voltage: 12.5nV/ $\sqrt{\text{Hz}}$ Typ
- Low Input Noise Current: 0.5pA/ $\sqrt{\text{Hz}}$ Typ
- Specified on 3.3V, 5V and \pm 15V
- Large Output Drive Current: 30mA Min
- Low Supply Current per Amplifier: 6.6mA Max
- Dual in 8-Pin DIP and SO-8
- Quad in 14-Pin DIP and NARROW SO-16

Note: For applications requiring less slew rate, see the LT1211/LT1212 and LT1213/LT1214 data sheets.

DESCRIPTION

The LT[®]1215 is a dual, single supply precision op amp with a 23MHz gain-bandwidth product and a 50V/ μ s slew rate. The LT1216 is a quad version of the same amplifier. The DC precision of the LT1215/LT1216 eliminates trims in most systems while providing high frequency performance not usually found in single supply amplifiers.

The LT1215/LT1216 will operate on any supply greater than 2.5V and less than 36V total. These amplifiers are specified on single 3.3V, single 5V and \pm 15V supplies, and only require 5mA of quiescent supply current per amplifier. The inputs can be driven beyond the supplies without damage or phase reversal of the output. The minimum output drive is 30mA, ideal for driving low impedance loads.

APPLICATIONS

- 2.5V Full-Scale 12-Bit Systems: $V_{OS} \leq 0.75$ LSB
- 10V Full-Scale 16-Bit Systems: $V_{OS} \leq 3$ LSB
- Active Filters
- Photo Diode Amplifiers
- DAC Current to Voltage Amplifiers
- Battery-Powered Systems

 LTC and LT are registered trademarks of Linear Technology Corporation.

TYPICAL APPLICATION

Single Supply Instrumentation Amplifier

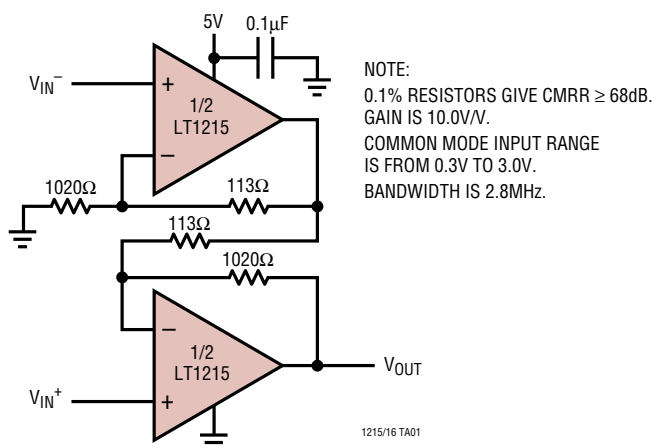

Frequency Response

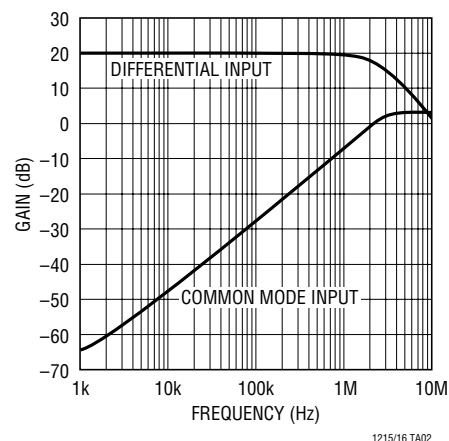

LT1215/LT1216

ABSOLUTE MAXIMUM RATINGS (Note 1)

Total Supply Voltage (V^+ to V^-)	36V	Storage Temperature Range	-65°C to 150°C
Input Current	±15mA	Junction Temperature (Note 5)	150°C
Output Short-Circuit Duration (Note 2)	Continuous	Plastic Package (CN8, CS8, CN, CS)	150°C
Operating Temperature Range		Ceramic Package (MJ8)	175°C
LT1215C/LT1216C (Note 3)	-40°C to 85°C	Lead Temperature (Soldering, 10 sec)	300°C
LT1215M	-55°C to 125°C		
Specified Temperature Range			
LT1215C/LT1216C (Note 4)	-40°C to 85°C		
LT1215M	-55°C to 125°C		

PACKAGE/ORDER INFORMATION

<p>J8 PACKAGE 8-LEAD CERDIP</p> <p>N8 PACKAGE 8-LEAD PDIP</p> <p>$T_{JMAX} = 175^\circ\text{C}$, $\theta_{JA} = 100^\circ\text{C/W}$ (J) $T_{JMAX} = 150^\circ\text{C}$, $\theta_{JA} = 100^\circ\text{C/W}$ (N)</p>	<p>ORDER PART NUMBER</p> <p>LT1215CN8 LT1215ACN8 LT1215MJ8 LT1215AMJ8</p>	<p>S8 PACKAGE 8-LEAD PLASTIC SO</p> <p>$T_{JMAX} = 150^\circ\text{C}$, $\theta_{JA} = 150^\circ\text{C/W}$</p>	<p>ORDER PART NUMBER</p> <p>LT1215CS8</p> <p>S8 PART MARKING</p> <p>1215</p>
<p>N PACKAGE 14-LEAD PDIP</p> <p>$T_{JMAX} = 150^\circ\text{C}$, $\theta_{JA} = 70^\circ\text{C/W}$</p>	<p>ORDER PART NUMBER</p> <p>LT1216CN</p>	<p>S PACKAGE 16-LEAD PLASTIC SO</p> <p>$T_{JMAX} = 150^\circ\text{C}$, $\theta_{JA} = 100^\circ\text{C/W}$</p>	<p>ORDER PART NUMBER</p> <p>LT1216CS</p>

AVAILABLE OPTIONS

NUMBER OF OP AMPS	T_A RANGE	MAX V_{OS} (25°C)	MAX TC V_{OS} ($\Delta V_{OS}/\Delta T$)	PACKAGE		
				CERAMIC (J)	PLASTIC DIP (N)	SURFACE MOUNT (S)
Two (Dual)	-40°C to 85°C	300µV	2.5µV/°C		LT1215ACN8	
		450µV	5µV/°C		LT1215CN8	
		450µV	10µV/°C			LT1215CS8
	-55°C to 125°C	300µV	2.5µV/°C	LT1215AMJ8		
450µV		5µV/°C	LT1215MJ8			
Four (Quad)	-40°C to 85°C	450µV	10µV/°C		LT1216CN	LT1216CS

5V ELECTRICAL CHARACTERISTICS

$V_S = 5V$, $V_{CM} = 0.5V$, $V_{OUT} = 0.5V$, $T_A = 25^\circ C$, unless otherwise noted.

SYMBOL	PARAMETER	CONDITIONS	LT1215AC LT1215AM			LT1215C/LT1215M LT1216C			UNITS
			MIN	TYP	MAX	MIN	TYP	MAX	
V_{OS}	Input Offset Voltage			125	300		150	450	μV
$\frac{\Delta V_{OS}}{\Delta Time}$	Long-Term Input Offset Voltage Stability			0.8			1.0		$\mu V/Mo$
I_{OS}	Input Offset Current			35	80		35	120	nA
I_B	Input Bias Current			420	500		420	600	nA
	Input Noise Voltage	0.1Hz to 10Hz		400			400		nV _{P-P}
e_n	Input Noise Voltage Density	$f_0 = 10Hz$ $f_0 = 1000Hz$		15.0 12.5			15.0 12.5		nV/ \sqrt{Hz} nV/ \sqrt{Hz}
i_n	Input Noise Current Density	$f_0 = 10Hz$ $f_0 = 1000Hz$		7.0 0.5			7.0 0.5		pA/ \sqrt{Hz} pA/ \sqrt{Hz}
	Input Resistance (Note 6)	Differential Mode Common Mode	10	40 200		10	40 200		M Ω M Ω
	Input Capacitance	$f = 1MHz$		10			10		pF
	Input Voltage Range		3.0 0	3.2 -0.2		3.0 0	3.2 -0.2		V V
CMRR	Common Mode Rejection Ratio	$V_{CM} = 0V$ to 3V	90	108		86	108		dB
PSRR	Power Supply Rejection Ratio	$V_S = 2.5V$ to 12.5V	96	115		93	115		dB
A_{VOL}	Large-Signal Voltage Gain	$V_0 = 0.05V$ to 3.7V, $R_L = 500\Omega$	150	600		150	600		V/mV
	Maximum Output Voltage Swing (Note 7)	Output High, No Load	4.30	4.39		4.30	4.39		V
		Output High, $I_{SOURCE} = 1mA$	4.20	4.30		4.20	4.30		V
		Output High, $I_{SOURCE} = 30mA$	3.60	3.75		3.60	3.75		V
		Output Low, No Load		0.005	0.008		0.005	0.008	V
		Output Low, $I_{SINK} = 1mA$		0.030	0.050		0.030	0.050	V
		Output Low, $I_{SINK} = 30mA$		0.630	1.000		0.630	1.000	V
I_O	Maximum Output Current	(Note 11)	± 30	± 50		± 30	± 50		mA
SR	Slew Rate	$A_V = -2$		30			30		V/ μs
GBW	Gain-Bandwidth Product	$f = 100kHz$		23			23		MHz
I_S	Supply Current Per Amplifier		3.6	4.75	6.6	3.6	4.75	6.6	mA
	Minimum Supply Voltage	Single Supply		2.2	2.5		2.2	2.5	V
	Full Power Bandwidth	$A_V = 1$, $V_0 = 2.5V_{P-P}$		2.6			2.6		MHz
t_r , t_f	Rise Time, Fall Time	$A_V = 1$, 10% to 90%, $V_0 = 100mV$		16			16		ns
OS	Overshoot	$A_V = 1$, $V_0 = 100mV$		25			25		%
t_{PD}	Propagation Delay	$A_V = 1$, $V_0 = 100mV$		13			13		ns
t_S	Settling Time	0.01%, $A_V = 1$, $\Delta V_0 = 2V$		250			250		ns
	Open-Loop Output Resistance	$I_0 = 0mA$, $f = 10MHz$		40			40		Ω
THD	Total Harmonic Distortion	$A_V = 1$, $V_0 = 1V_{RMS}$, 20Hz to 20kHz		0.001			0.001		%

5V ELECTRICAL CHARACTERISTICS

$V_S = 5V$, $V_{CM} = 0.5V$, $V_{OUT} = 0.5V$, $0^\circ C \leq T_A \leq 70^\circ C$, unless otherwise noted.

SYMBOL	PARAMETER	CONDITIONS	LT1215AC			LT1215C/LT1216C			UNITS
			MIN	TYP	MAX	MIN	TYP	MAX	
V_{OS}	Input Offset Voltage			200	350		250	550	μV
$\frac{\Delta V_{OS}}{\Delta T}$	Input Offset Voltage Drift (Note 6)	8-Pin DIP Package 14-Pin DIP, SO Package		1	2.5		2 3	5 10	$\mu V/^\circ C$ $\mu V/^\circ C$
I_{OS}	Input Offset Current			35	100		35	170	nA
I_B	Input Bias Current			450	530		450	830	nA
	Input Voltage Range		2.9 0.1	3.1 -0.1		2.9 0.1	3.1 -0.1		V V
CMRR	Common Mode Rejection Ratio	$V_{CM} = 0.1V$ to 2.9V	89	108		85	108		dB
PSRR	Power Supply Rejection Ratio	$V_S = 2.6V$ to 12.5V	95	114		92	114		dB
A_{VOL}	Large-Signal Voltage Gain	$V_O = 0.05V$ to 3.7V, $R_L = 500\Omega$	100	600		100	600		V/mV
	Maximum Output Voltage Swing (Note 7)	Output High, No Load	4.20	4.33		4.20	4.33		V
		Output High, $I_{SOURCE} = 1mA$	4.10	4.24		4.10	4.24		V
		Output High, $I_{SOURCE} = 20mA$	3.70	3.89		3.70	3.89		V
		Output Low, No Load		0.006	0.009		0.006	0.009	V
		Output Low, $I_{SINK} = 1mA$		0.035	0.055		0.035	0.055	V
		Output Low, $I_{SINK} = 20mA$		0.500	0.725		0.500	0.725	V
I_S	Supply Current Per Amplifier		3.3	5.2	7.5	3.3	5.2	7.5	mA

$V_S = 5V$, $V_{CM} = 0.5V$, $V_{OUT} = 0.5V$, $-40^\circ C \leq T_A \leq 85^\circ C$, unless otherwise noted. (Note 4)

SYMBOL	PARAMETER	CONDITIONS	LT1215AC			LT1215C/LT1216C			UNITS
			MIN	TYP	MAX	MIN	TYP	MAX	
V_{OS}	Input Offset Voltage			200	400		250	600	μV
$\frac{\Delta V_{OS}}{\Delta T}$	Input Offset Voltage Drift (Note 6)	8-Pin DIP Package 14-Pin DIP, SO Package		1	2.5		2 3	5 10	$\mu V/^\circ C$ $\mu V/^\circ C$
I_{OS}	Input Offset Current			35	110		35	190	nA
I_B	Input Bias Current			450	550		450	850	nA
	Input Voltage Range		2.8 0.2	3.0 0		2.8 0.2	3.0 0		V V
CMRR	Common Mode Rejection Ratio	$V_{CM} = 0.2V$ to 2.8V	88	108		84	108		dB
PSRR	Power Supply Rejection Ratio	$V_S = 2.7V$ to 12.5V	94	114		91	114		dB
A_{VOL}	Large-Signal Voltage Gain	$V_O = 0.05V$ to 3.7V, $R_L = 500\Omega$	100	600		100	600		V/mV
	Maximum Output Voltage Swing (Note 7)	Output High, No Load	4.10	4.30		4.10	4.30		V
		Output High, $I_{SOURCE} = 1mA$	4.00	4.16		4.00	4.16		V
		Output High, $I_{SOURCE} = 20mA$	3.60	3.82		3.60	3.82		V
		Output Low, No Load		0.006	0.010		0.006	0.010	V
		Output Low, $I_{SINK} = 1mA$		0.035	0.060		0.035	0.060	V
		Output Low, $I_{SINK} = 20mA$		0.500	0.750		0.500	0.750	V
I_S	Supply Current Per Amplifier		2.9	5.3	7.6	2.9	5.3	7.6	mA

5V ELECTRICAL CHARACTERISTICS

$V_S = 5V$, $V_{CM} = 0.5V$, $V_{OUT} = 0.5V$, $-55^\circ C \leq T_A \leq 125^\circ C$, unless otherwise noted.

SYMBOL	PARAMETER	CONDITIONS	LT1215AM			LT1215M			UNITS
			MIN	TYP	MAX	MIN	TYP	MAX	
V_{OS}	Input Offset Voltage			250	450		350	750	μV
$\frac{\Delta V_{OS}}{\Delta T}$	Input Offset Voltage Drift (Note 6)			1	2.5		2	5	$\mu V/^\circ C$
I_{OS}	Input Offset Current			35	150		35	200	nA
I_B	Input Bias Current			450	600		450	700	nA
	Input Voltage Range		2.8	3.0		2.8	3.0		V
			0.4	0.2		0.4	0.2		V
CMRR	Common Mode Rejection Ratio	$V_{CM} = 0.4V$ to $2.8V$	87	108		82	108		dB
PSRR	Power Supply Rejection Ratio	$V_S = 2.7V$ to $12.5V$	93	114		90	114		dB
A_{VOL}	Large-Signal Voltage Gain	$V_O = 0.05V$ to $3.7V$, $R_L = 500\Omega$	50	100		50	100		V/mV
	Maximum Output Voltage Swing (Note 7)	Output High, No Load	4.00	4.20		4.00	4.20		V
		Output High, $I_{SOURCE} = 1mA$	3.90	4.10		3.90	4.10		V
		Output High, $I_{SOURCE} = 20mA$	3.50	3.80		3.50	3.80		V
		Output Low, No Load		0.007	0.012		0.007	0.012	mV
		Output Low, $I_{SINK} = 1mA$		0.040	0.070		0.040	0.070	mV
		Output Low, $I_{SINK} = 20mA$		0.700	1.000		0.700	1.000	mV
I_S	Supply Current Per Amplifier		2.3	5.5	8.4	2.3	5.5	8.4	mA

$\pm 15V$ ELECTRICAL CHARACTERISTICS

$V_S = \pm 15V$, $V_{CM} = 0V$, $V_{OUT} = 0V$, $T_A = 25^\circ C$, unless otherwise noted.

SYMBOL	PARAMETER	CONDITIONS	LT1215AC LT1215AM			LT1215C/LT1215M LT1216C			UNITS
			MIN	TYP	MAX	MIN	TYP	MAX	
V_{OS}	Input Offset Voltage			225	500		250	650	μV
I_{OS}	Input Offset Current			30	80		30	110	nA
I_B	Input Bias Current			360	500		360	550	nA
	Input Voltage Range		13.0	13.2		13.0	13.2		V
			-15.0	-15.2		-15.0	-15.2		V
CMRR	Common Mode Rejection Ratio	$V_{CM} = -15V$ to $13V$	90	108		86	108		dB
PSRR	Power Supply Rejection Ratio	$V_S = \pm 2V$ to $\pm 18V$	96	110		93	110		dB
A_{VOL}	Large-Signal Voltage Gain	$V_O = 0V$ to $\pm 10V$, $R_L = 2k$	1000	3500		1000	3500		V/mV
	Maximum Output Voltage Swing	Output High, $I_{SOURCE} = 30mA$	13.5	13.75		13.5	13.75		V
		Output Low, $I_{SINK} = 30mA$	-14	-14.4		-14	-14.4		V
I_O	Maximum Output Current	(Note 11)	± 30	± 50		± 30	± 50		mA
SR	Slew Rate	$A_V = -2$ (Note 8)	40	50		40	50		V/ μs
GBW	Gain-Bandwidth Product	$f = 100kHz$	15	23		15	23		MHz
I_S	Supply Current Per Amplifier		3.6	5.7	8	3.6	5.7	8	mA
	Channel Separation	$V_O = \pm 10V$, $R_L = 2k$	128	140		128	140		dB
	Minimum Supply Voltage	Equal Split Supplies		± 1.7	± 2		± 1.7	± 2	V
	Full-Power Bandwidth	$A_V = 1$, $V_O = 20V_{P-P}$		750			750		kHz
	Settling Time	0.01%, $A_V = 1$, $\Delta V_O = 10V$		480			480		ns

±15V ELECTRICAL CHARACTERISTICS

$V_S = \pm 15V$, $V_{CM} = 0V$, $V_{OUT} = 0V$, $0^\circ C \leq T_A \leq 70^\circ C$, unless otherwise noted.

SYMBOL	PARAMETER	CONDITIONS	LT1215AC			LT1215C/LT1216C			UNITS	
			MIN	TYP	MAX	MIN	TYP	MAX		
V_{OS}	Input Offset Voltage			325	550		400	750	μV	
$\frac{\Delta V_{OS}}{\Delta T}$	Input Offset Voltage Drift (Note 6)	8-Pin DIP Package 14-Pin DIP, SO Package		1	2.5		2	5	$\mu V/^\circ C$ $\mu V/^\circ C$	
I_{OS}	Input Offset Current			30	100		30	160	nA	
I_B	Input Bias Current			360	530		360	800	nA	
	Input Voltage Range		12.9 -14.9	13.1 -15.1		12.9 -14.9	13.1 -15.1		V V	
CMRR	Common Mode Rejection Ratio	$V_{CM} = -14.9V$ to $12.9V$		89	108		85	108	dB	
PSRR	Power Supply Rejection Ratio	$V_S = \pm 2.1V$ to $\pm 18V$		95	110		92	110	dB	
A_{VOL}	Large-Signal Voltage Gain	$V_O = 0V$ to $\pm 10V$, $R_L = 2k$		800	3000		800	3000	V/mV	
	Maximum Output Voltage Swing	Output High, $I_{SOURCE} = 20mA$		13.7	13.9		13.7	13.9	V	
		Output Low, $I_{SINK} = 20mA$		-14.2	-14.5		-14.2	-14.5	V	
I_S	Supply Current Per Amplifier			3.3	6.3	9.2	3.3	6.3	9.2	mA

$V_S = \pm 15V$, $V_{CM} = 0V$, $V_{OUT} = 0V$, $-40^\circ C \leq T_A \leq 85^\circ C$, unless otherwise noted. (Note 4)

SYMBOL	PARAMETER	CONDITIONS	LT1215AC			LT1215C/LT1216C			UNITS	
			MIN	TYP	MAX	MIN	TYP	MAX		
V_{OS}	Input Offset Voltage			325	600		400	800	μV	
$\frac{\Delta V_{OS}}{\Delta T}$	Input Offset Voltage Drift (Note 6)	8-Pin DIP Package 14-Pin DIP, SO Package		1	2.5		2	5	$\mu V/^\circ C$ $\mu V/^\circ C$	
I_{OS}	Input Offset Current			30	110		30	180	nA	
I_B	Input Bias Current			360	550		360	820	nA	
	Input Voltage Range		12.8 -14.8	13.0 -15.0		12.8 -14.8	13.0 -15.0		V V	
CMRR	Common Mode Rejection Ratio	$V_{CM} = -14.8V$ to $12.8V$		88	108		84	108	dB	
PSRR	Power Supply Rejection Ratio	$V_S = \pm 2.2V$ to $\pm 18V$		94	110		91	110	dB	
A_{VOL}	Large-Signal Voltage Gain	$V_O = 0V$ to $\pm 10V$, $R_L = 2k$		800	2500		800	2500	V/mV	
	Maximum Output Voltage Swing	Output High, $I_{SOURCE} = 20mA$		13.6	13.8		13.6	13.8	V	
		Output Low, $I_{SINK} = 20mA$		-14.1	-14.5		-14.1	-14.5	V	
I_S	Supply Current Per Amplifier			2.9	6.5	9.5	2.9	6.5	9.5	mA

$V_S = \pm 15V$, $V_{CM} = 0V$, $V_{OUT} = 0V$, $-55^\circ C \leq T_A \leq 125^\circ C$, unless otherwise noted.

SYMBOL	PARAMETER	CONDITIONS	LT1215AM			LT1215M			UNITS	
			MIN	TYP	MAX	MIN	TYP	MAX		
V_{OS}	Input Offset Voltage			350	650		500	950	μV	
$\frac{\Delta V_{OS}}{\Delta T}$	Input Offset Voltage Drift (Note 6)			1	2.5		2	5	$\mu V/^\circ C$	
I_{OS}	Input Offset Current			30	150		30	200	nA	
I_B	Input Bias Current			360	600		360	700	nA	
	Input Voltage Range		12.8 -14.6	13.0 -14.8		12.8 -14.6	13.0 -14.8		V V	
CMRR	Common Mode Rejection Ratio	$V_{CM} = -14.6V$ to $12.8V$		87	108		82	108	dB	
PSRR	Power Supply Rejection Ratio	$V_S = \pm 2.2V$ to $\pm 15V$		93	110		90	110	dB	
A_{VOL}	Large-Signal Voltage Gain	$V_O = 0V$ to $\pm 10V$, $R_L = 2k$		500	2000		500	2000	V/mV	
	Maximum Output Voltage Swing	Output High, $I_{SOURCE} = 20mA$		13.4	13.8		13.4	13.8	V	
		Output Low, $I_{SINK} = 20mA$		-14	-14.5		-14	-14.5	V	
I_S	Supply Current Per Amplifier			2.3	7	10.3	2.3	7	10.3	mA

3.3V ELECTRICAL CHARACTERISTICS

$V_S = 3.3V$, $V_{CM} = 0.5V$, $V_{OUT} = 0.5V$, $T_A = 25^\circ C$, unless otherwise noted. (Note 8)

SYMBOL	PARAMETER	CONDITIONS	LT1215AC LT1215AM			LT1215C/LT1215M LT1216C			UNITS
			MIN	TYP	MAX	MIN	TYP	MAX	
V_{OS}	Input Offset Voltage			125	300		150	450	μV
	Input Voltage Range (Note 10)		1.3	1.5		1.3	1.5		V
	Maximum Output Voltage Swing	Output High, No Load	2.60	2.69		2.60	2.69		V
		Output High, $I_{SOURCE} = 1mA$	2.50	2.60		2.50	2.60		V
		Output High, $I_{SOURCE} = 30mA$	1.90	2.05		1.90	2.05		V
		Output Low, No Load		0.005	0.008		0.005	0.008	V
		Output Low, $I_{SINK} = 1mA$		0.035	0.050		0.035	0.050	V
		Output Low, $I_{SINK} = 30mA$		0.700	1.000		0.700	1.000	V
I_O	Maximum Output Current		± 30	± 50		± 30	± 50	mA	

$V_S = 3.3V$, $V_{CM} = 0.5V$, $V_{OUT} = 0.5V$, $0^\circ C \leq T_A \leq 70^\circ C$, unless otherwise noted. (Note 9)

SYMBOL	PARAMETER	CONDITIONS	LT1215AC			LT1215C/LT1216C			UNITS
			MIN	TYP	MAX	MIN	TYP	MAX	
V_{OS}	Input Offset Voltage			200	350		250	550	μV
	Input Voltage Range (Note 10)		1.2	1.4		1.2	1.4		V
	Maximum Output Voltage Swing	Output High, No Load	2.50	2.63		2.50	2.63		V
		Output High, $I_{SOURCE} = 1mA$	2.40	2.54		2.40	2.54		V
		Output High, $I_{SOURCE} = 20mA$	2.00	2.19		2.00	2.19		V
		Output Low, No Load		0.006	0.009		0.006	0.009	V
		Output Low, $I_{SINK} = 1mA$		0.035	0.055		0.035	0.055	V
		Output Low, $I_{SINK} = 20mA$		0.500	0.725		0.500	0.725	V

$V_S = 3.3V$, $V_{CM} = 0.5V$, $V_{OUT} = 0.5V$, $-40^\circ C \leq T_A \leq 85^\circ C$, unless otherwise noted. (Notes 4, 9)

SYMBOL	PARAMETER	CONDITIONS	LT1215AC			LT1215C/LT1216C			UNITS
			MIN	TYP	MAX	MIN	TYP	MAX	
V_{OS}	Input Offset Voltage			200	400		250	600	μV
	Input Voltage Range (Note 10)		1.1	1.3		1.1	1.3		V
	Maximum Output Voltage Swing	Output High, No Load	2.40	2.50		2.40	2.50		V
		Output High, $I_{SOURCE} = 1mA$	2.30	2.46		2.30	2.46		V
		Output High, $I_{SOURCE} = 20mA$	1.90	2.12		1.90	2.12		V
		Output Low, No Load		0.006	0.010		0.006	0.010	V
		Output Low, $I_{SINK} = 1mA$		0.035	0.060		0.035	0.060	V
		Output Low, $I_{SINK} = 20mA$		0.500	0.750		0.500	0.750	V

$V_S = 3.3V$, $V_{CM} = 0.5V$, $V_{OUT} = 0.5V$, $-55^\circ C \leq T_A \leq 125^\circ C$, unless otherwise noted. (Note 9)

SYMBOL	PARAMETER	CONDITIONS	LT1215AM			LT1215M			UNITS
			MIN	TYP	MAX	MIN	TYP	MAX	
V_{OS}	Input Offset Voltage			250	450		350	750	μV
	Input Voltage Range (Note 10)		1.1	1.3		1.1	1.3		V
	Maximum Output Voltage Swing	Output High, No Load	2.30	2.50		2.30	2.50		V
		Output High, $I_{SOURCE} = 1mA$	2.20	2.40		2.20	2.40		V
		Output High, $I_{SOURCE} = 20mA$	1.80	2.10		1.80	2.10		V
		Output Low, No Load		0.007	0.012		0.007	0.012	V
		Output Low, $I_{SINK} = 1mA$		0.040	0.070		0.040	0.070	V
		Output Low, $I_{SINK} = 20mA$		0.700	1.000		0.700	1.000	V

ELECTRICAL CHARACTERISTICS

Note 1: Absolute Maximum Ratings are those values beyond which the life of a device may be impaired.

Note 2: A heat sink may be required to keep the junction temperature below absolute maximum when the output is shorted indefinitely.

Note 3: The LT1215C/LT1216C are guaranteed functional over the operating temperature range of -40°C to 85°C . The LT1215M is guaranteed functional over the operating temperature range of -55°C to 125°C .

Note 4: The LT1215C/LT1216C are guaranteed to meet specified performance from 0°C to 70°C . The LT1215C/LT1216C are designed, characterized and expected to meet specified performance from -40°C to 85°C but are not tested or QA sampled at these temperatures. For guaranteed I-grade parts consult the factory. The LT1215M is guaranteed to meet specified performance from -55°C to 125°C .

Note 5: T_J is calculated from the ambient temperature T_A and power dissipation P_D according to the following formulas:

$$\begin{aligned} \text{LT1215MJ8, LT1215AMJ8: } & T_J = T_A + (P_D \cdot 100^{\circ}\text{C/W}) \\ \text{LT1215CN8, LT1215ACN8: } & T_J = T_A + (P_D \cdot 100^{\circ}\text{C/W}) \\ \text{LT1215CS8: } & T_J = T_A + (P_D \cdot 150^{\circ}\text{C/W}) \\ \text{LT1216CN: } & T_J = T_A + (P_D \cdot 70^{\circ}\text{C/W}) \\ \text{LT1216CS: } & T_J = T_A + (P_D \cdot 100^{\circ}\text{C/W}) \end{aligned}$$

Note 6: This parameter is not 100% tested.

Note 7: Guaranteed by correlation to 3.3V and $\pm 15\text{V}$ tests.

Note 8: Slew rate is measured between $\pm 8.5\text{V}$ on an output swing of $\pm 10\text{V}$ on $\pm 15\text{V}$ supplies.

Note 9: Most LT1215/LT1216 electrical characteristics change very little with supply voltage. See the 5V tables for characteristics not listed in the 3.3V table.

Note 10: Guaranteed by correlation to 5V and $\pm 15\text{V}$ tests.

Note 11: Guaranteed by correlation to 3.3V tests.

TYPICAL PERFORMANCE CHARACTERISTICS

Distribution of Input Offset Voltage

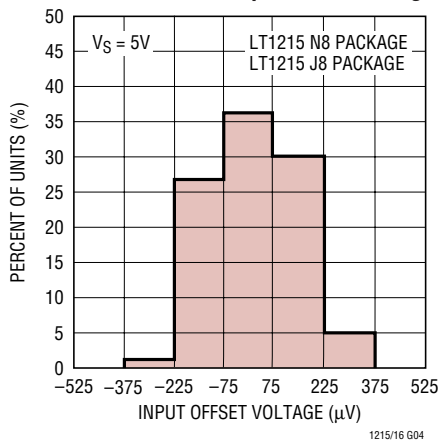

Distribution of Offset Voltage Drift with Temperature

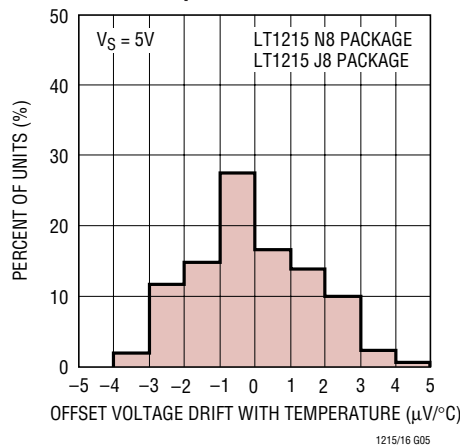

Distribution of Input Offset Voltage

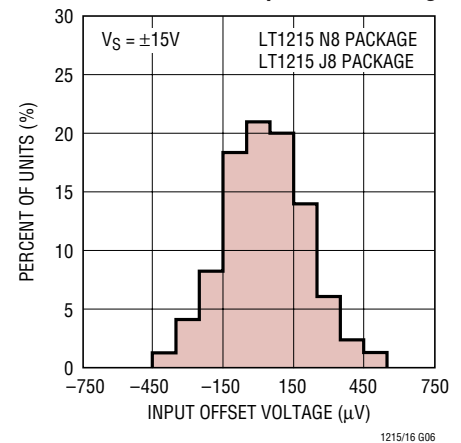

Distribution of Input Offset Voltage

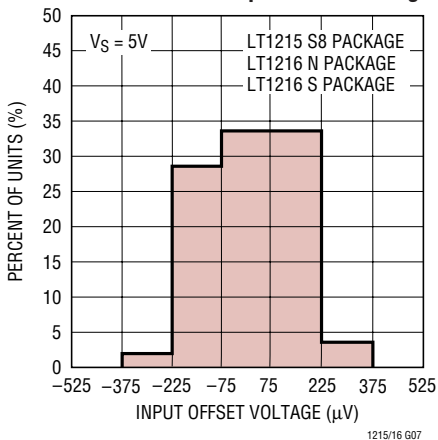

Distribution of Offset Voltage Drift with Temperature

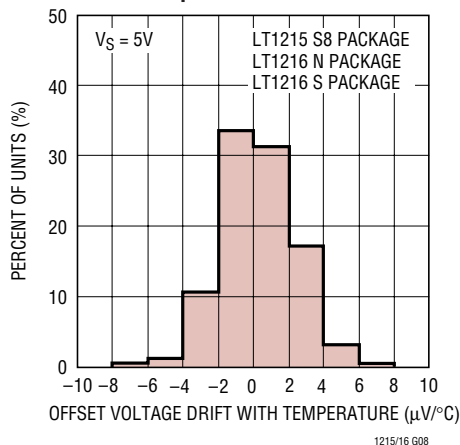

Distribution of Input Offset Voltage

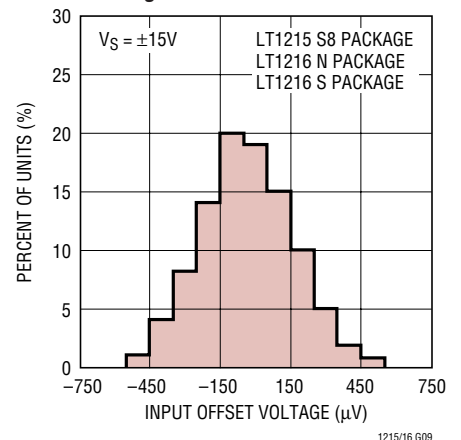

TYPICAL PERFORMANCE CHARACTERISTICS

Voltage Gain vs Frequency

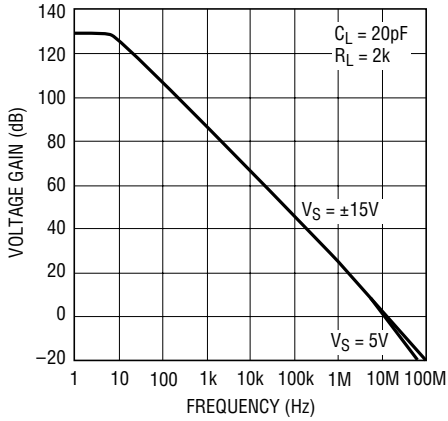

1215/16 G10

Voltage Gain, Phase vs Frequency

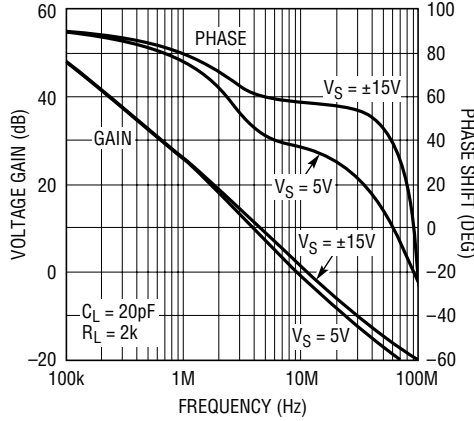

1215/16 G11

Gain-Bandwidth Product, Phase Margin vs Supply Voltage

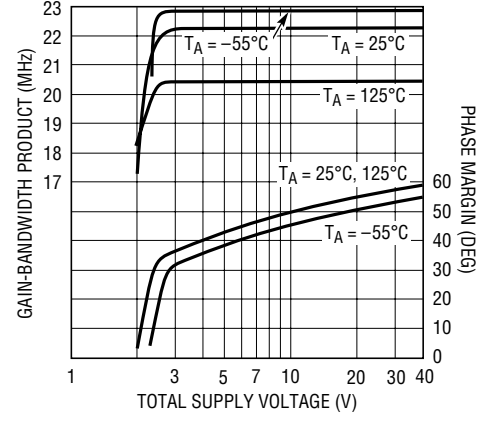

1215/16 G12

Slew Rate vs Temperature

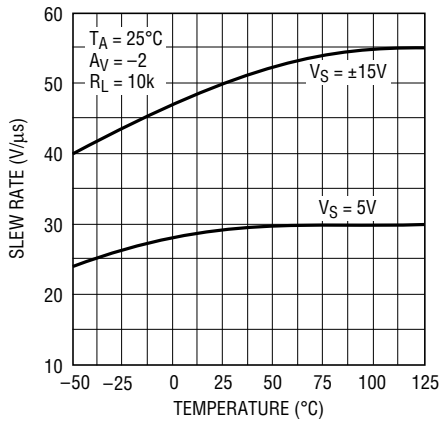

1215/16 G13

Slew Rate vs Supply Voltage

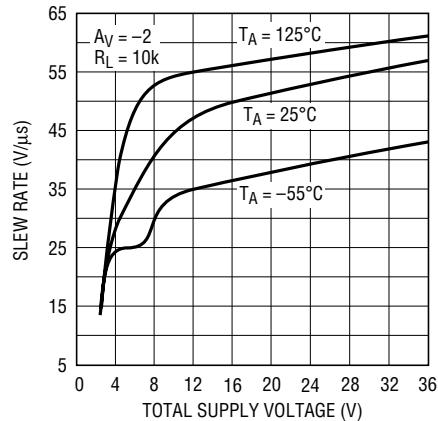

1215/16 G14

Capacitive Load Handling

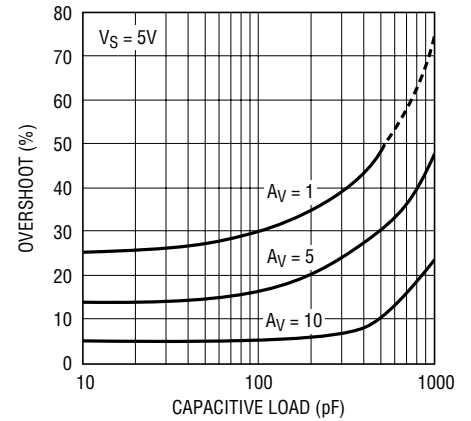

1216/ G15

Undistorted Output Swing vs Frequency, VS = 5V

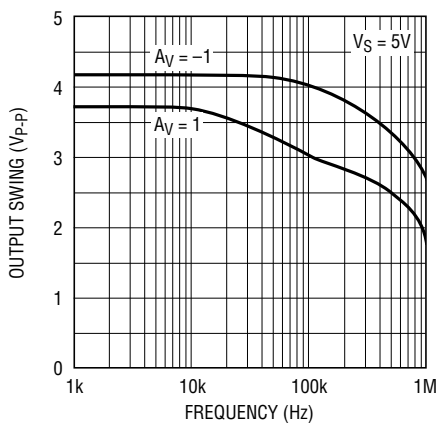

1215/16 G16

Undistorted Output Swing vs Frequency, VS = ±15V

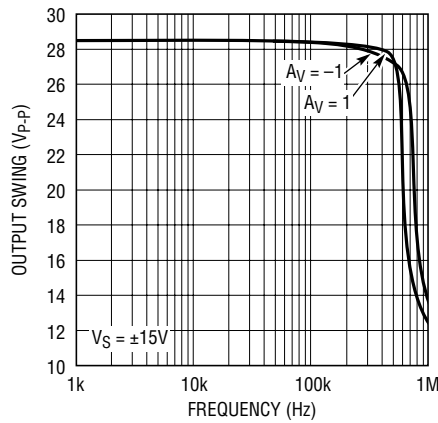

1215/16 G17

Total Harmonic Distortion and Noise vs Frequency

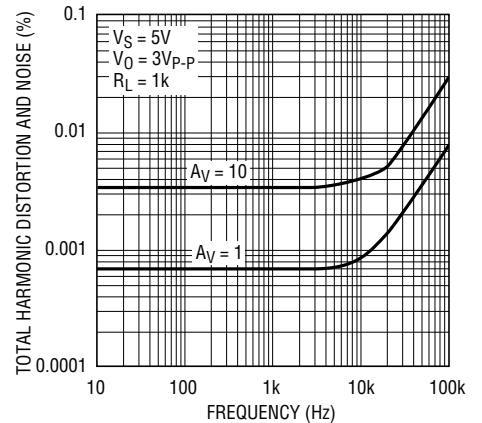

1215/16 G18

TYPICAL PERFORMANCE CHARACTERISTICS

Open-Loop Voltage Gain vs Supply Voltage

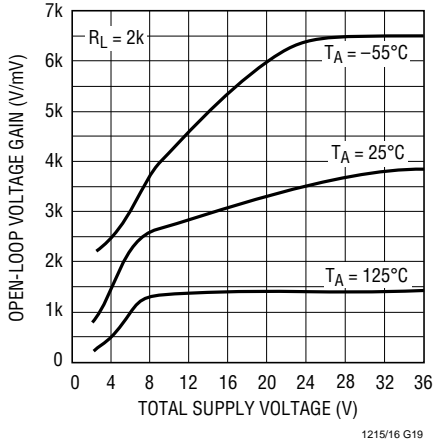

1215/16 G19

Open-Loop Gain, VS = 5V

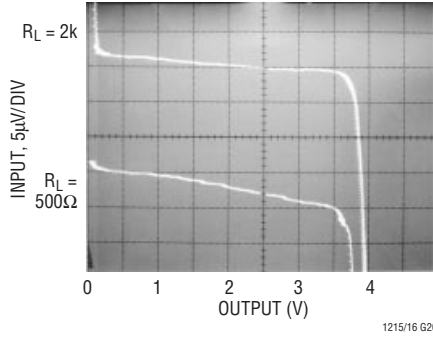

1215/16 G20

Positive Output Saturation Voltage vs Temperature

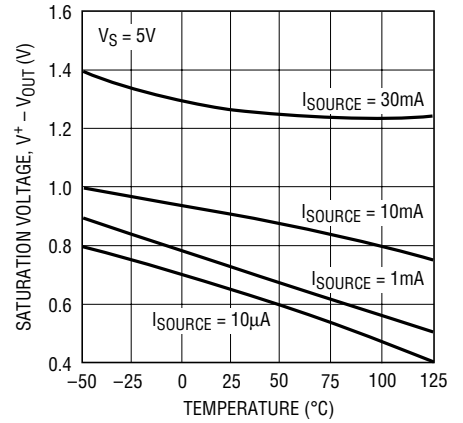

1215/16 G21

Voltage Gain vs Load Resistance

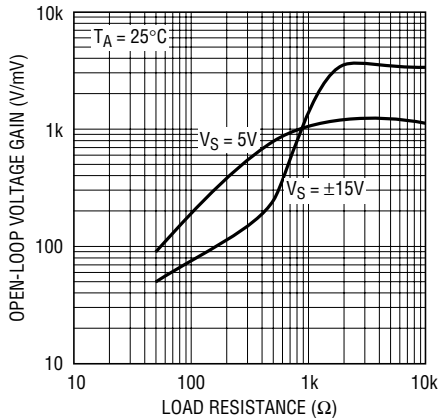

1215/16 G22

Open-Loop Gain, VS = ±15V

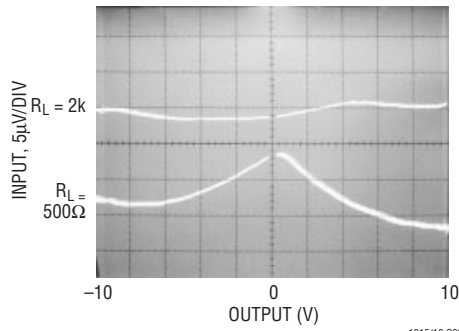

1215/16 G23

Negative Output Saturation Voltage vs Temperature

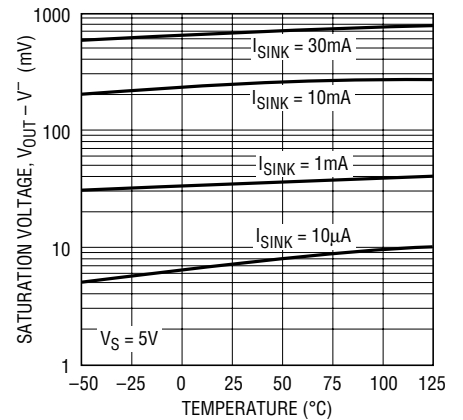

1215/16 G24

Channel Separation vs Frequency

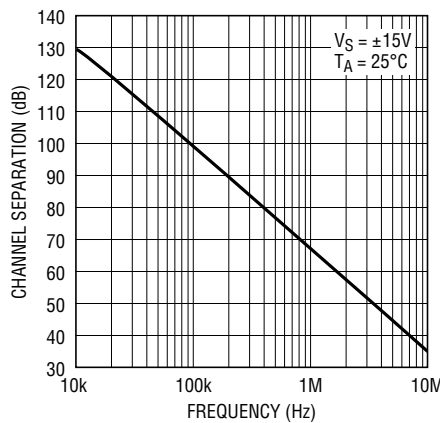

1215/16 G25

Output Short-Circuit Current vs Temperature

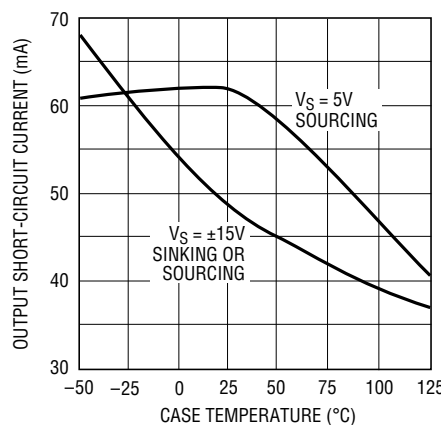

1215/16 G26

Output Impedance vs Frequency

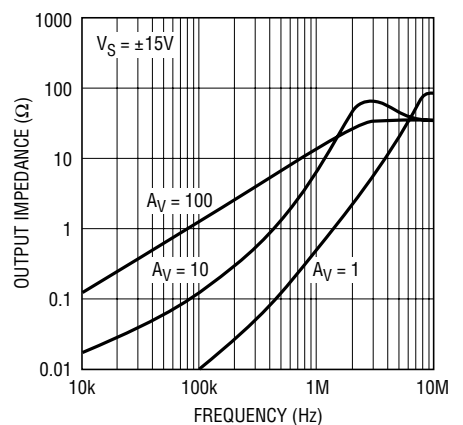

1215/16 G27

TYPICAL PERFORMANCE CHARACTERISTICS

5V Small-Signal Response

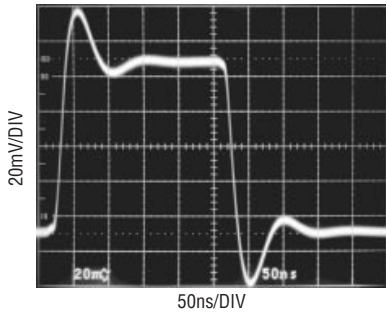

$V_S = 5V$
 $A_V = 1$
1215/16 G34

5V Large-Signal Response

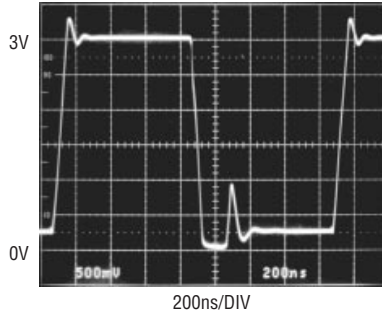

$V_S = 5V$
 $A_V = 1$
1215/16 G28

5V Large-Signal Response

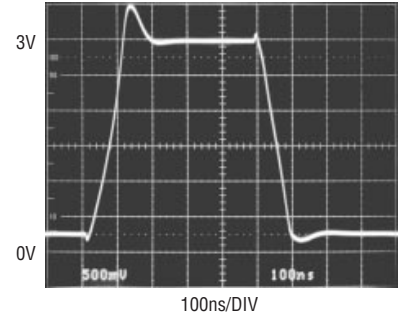

$V_S = 5V$
 $A_V = -1$
 $R_F = R_G = 1k$
 $C_F = 20pF$
1215/16 G31

±15V Small-Signal Response

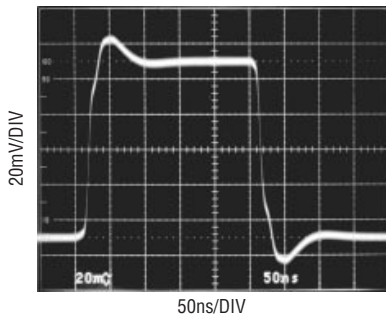

$V_S = \pm 15V$
 $A_V = 1$
1215/16 G34

±15V Large-Signal Response

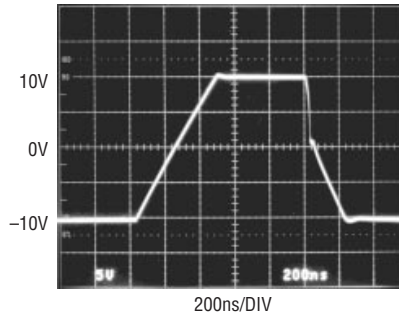

$V_S = \pm 15V$
 $A_V = 1$
1215/16 G29

±15V Large-Signal Response

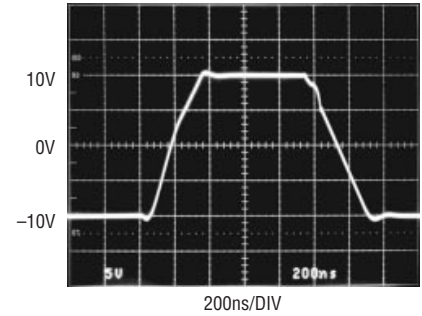

$V_S = \pm 15V$
 $A_V = -1$
 $R_F = R_G = 1k$
1215/16 G32

5V Settling

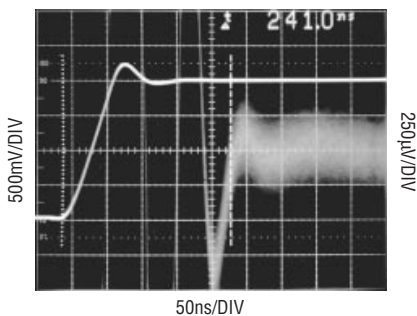

$V_S = 5V$
 $A_V = 1$
1215/16 G30

±15V Settling

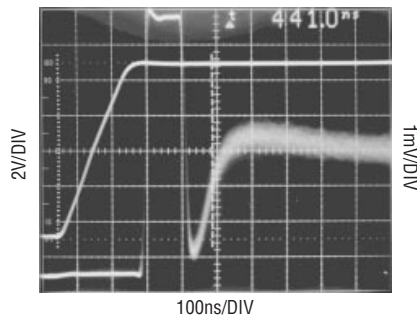

$V_S = \pm 15V$
 $A_V = -1$
1215/16 G33

Settling Time to 0.01% vs Output Step

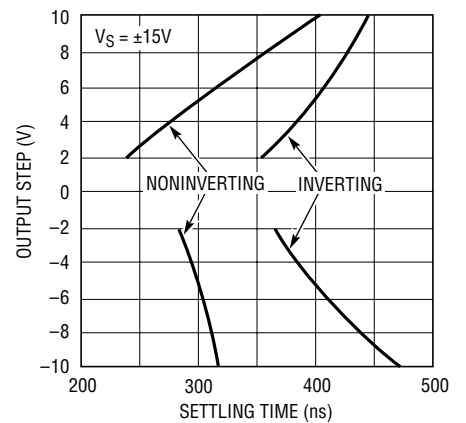

1215/16 G36

TYPICAL PERFORMANCE CHARACTERISTICS

Supply Current vs Supply Voltage

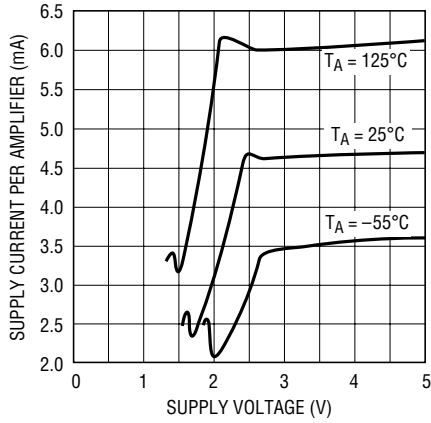

1215/16 G01

Supply Current vs Temperature

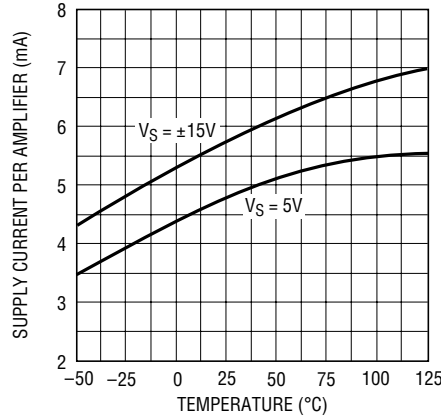

1215/16 G02

Warm-Up Drift vs Time

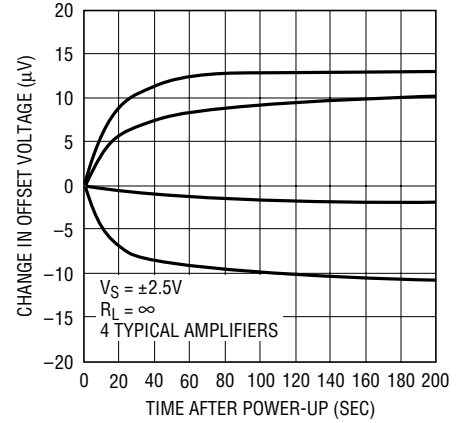

1215/16 G03

Input Bias Current vs Temperature

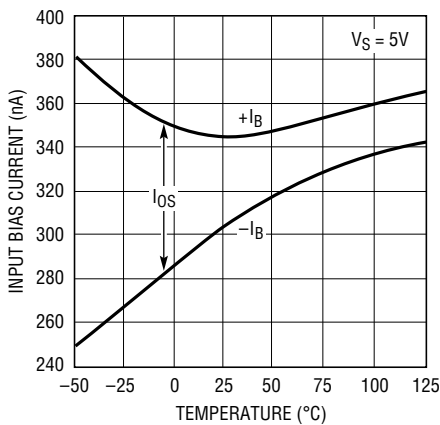

1215/16 G37

Input Bias Current vs Common Mode Voltage

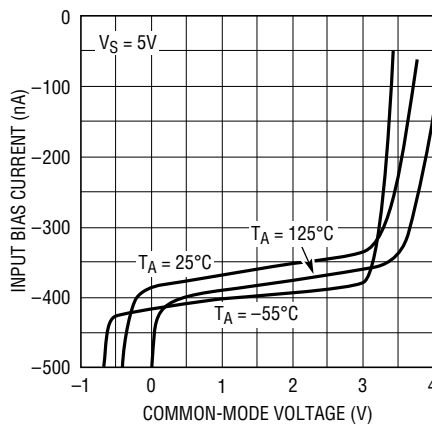

1215/16 G38

Common Mode Range vs Temperature

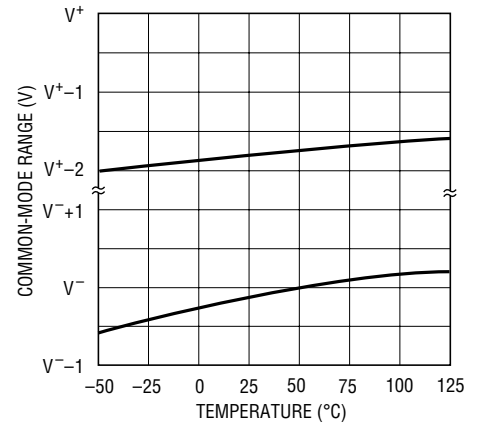

1215/16 G39

Input Noise Current, Noise Voltage Density vs Frequency

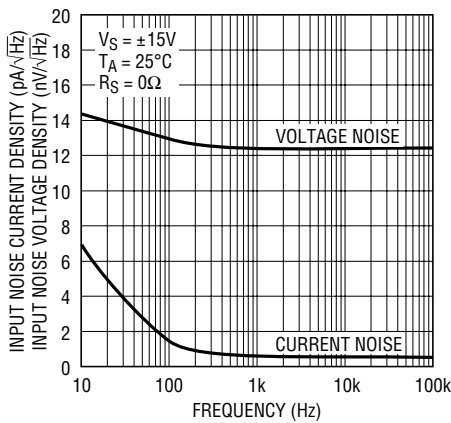

1215/16 G40

Common Mode Rejection Ratio vs Frequency

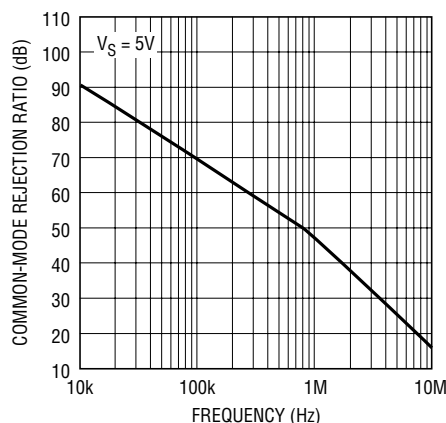

1215/16 G41

Input Referred Power Supply Rejection Ratio vs Frequency

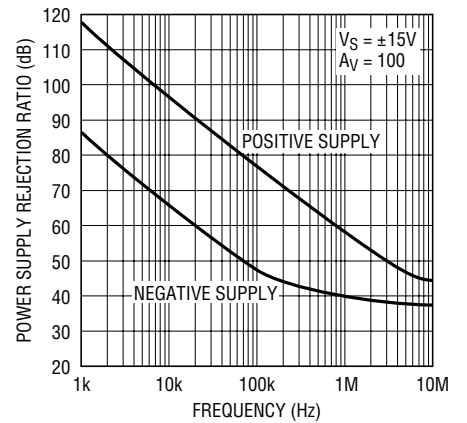

1215/16 G42

APPLICATIONS INFORMATION

Supply Voltage

The LT1215/LT1216 op amps are fully functional and all internal bias circuits are in regulation with 2.2V of supply. The amplifiers will continue to function with as little as 1.5V, although the input common mode range and the phase margin are about gone. The minimum operating supply voltage is guaranteed by the PSRR tests which are done with the input common mode equal to 500mV and a minimum supply voltage of 2.5V. The LT1215/LT1216 are guaranteed over the full -55°C to 125°C range with a minimum supply voltage of 2.7V.

The positive supply pin of the LT1215/LT1216 should be bypassed with a small capacitor (about $0.01\mu\text{F}$) within an inch of the pin. When driving heavy loads and for good settling time, an additional $4.7\mu\text{F}$ capacitor should be used. When using split supplies, the same is true for the negative supply pin.

Power Dissipation

The LT1215/LT1216 amplifiers combine high speed and large output current drive into very small packages. Because these amplifiers work over a very wide supply range, it is possible to exceed the maximum junction temperature under certain conditions. To insure that the LT1215/LT1216 are used properly, calculate the worst case power dissipation, define the maximum ambient temperature, select the appropriate package and then calculate the maximum junction temperature.

The worst case amplifier power dissipation is the total of the quiescent current times the total power supply voltage plus the power in the IC due to the load. The quiescent supply current of the LT1215/LT1216 has a positive temperature coefficient. The maximum supply current of each amplifier at 125°C is given by the following formula:

$$I_{\text{SMAX}} = 8.4 + 0.076 \cdot (V_{\text{S}} - 5) \text{ in mA}$$

V_{S} is the total supply voltage.

The power in the IC due to the load is a function of the output voltage, the supply voltage and load resistance. The worst case occurs when the output voltage is at half supply, if it can go that far, or its maximum value if it cannot reach half supply.

For example, calculate the worst case power dissipation while operating on $\pm 15\text{V}$ supplies and driving a 500Ω load.

$$I_{\text{SMAX}} = 8.4 + 0.076 \cdot (30 - 5) = 10.3\text{mA}$$

$$P_{\text{DMAX}} = 2 \cdot V_{\text{S}} \cdot I_{\text{SMAX}} + (V_{\text{S}} - V_{\text{OMAX}}) \cdot V_{\text{OMAX}}/R_{\text{L}}$$

$$P_{\text{DMAX}} = 2 \cdot 15\text{V} \cdot 10.3\text{mA} + (15\text{V} - 7.5\text{V}) \cdot 7.5\text{V}/500 \\ = 0.309 + 0.113 = 0.422 \text{ Watt per Amp}$$

If this is the dual LT1215, the total power in the package is twice that, or 0.844W . Now calculate how much the die temperature will rise above the ambient. The total power dissipation times the thermal resistance of the package gives the amount of temperature rise. For this example, in the SO-8 surface mount package, the thermal resistance is $150^{\circ}\text{C}/\text{W}$ junction-to-ambient in still air.

$$\text{Temperature Rise} = P_{\text{DMAX}} \cdot \theta_{\text{JA}} = 0.844\text{W} \cdot 150^{\circ}\text{C}/\text{W} \\ = 126.6^{\circ}\text{C}$$

The maximum junction temperature allowed in the plastic package is 150°C . Therefore the maximum ambient allowed is the maximum junction temperature less the temperature rise.

$$\text{Maximum Ambient} = 150^{\circ}\text{C} - 126.6^{\circ}\text{C} = 23.4^{\circ}\text{C}$$

That means the SO-8 dual can only be operated at or below room temperature on $\pm 15\text{V}$ supplies with a 500Ω load. Obviously this is not recommended. Lowering the supply voltage is recommended, or use the DIP packaged part.

As a guideline to help in the selection of the LT1215/LT1216, the following table describes the maximum supply voltage that can be used with each part based on the following assumptions:

1. The maximum ambient is 70°C or 125°C depending on the part rating.
2. The load is 500Ω , includes the feedback resistors.
3. The output can be anywhere between the supplies.

PART	MAX SUPPLIES	MAX POWER AT MAX T_{A}
LT1215MJ8	15.0V or $\pm 10.3\text{V}$	500mW
LT1215CN8	20.3V or $\pm 14.5\text{V}$	800mW
LT1215CS8	15.7V or $\pm 10.8\text{V}$	533mW
LT1216CN	16.4V or $\pm 11.4\text{V}$	1143mW
LT1216CS	13.0V or $\pm 8.7\text{V}$	800mW

APPLICATIONS INFORMATION

Inputs

Typically at room temperature, the inputs of the LT1215/LT1216 can common mode 400mV below ground (V^-) and to within 1.5V of the positive supply with the amplifier still functional. However the input bias current and offset voltage will shift as shown in the characteristic curves. For full precision performance, the common mode range should be limited between ground (V^-) and 2V below the positive supply.

When either of the inputs is taken below ground (V^-) by more than about 700mV, that input current will increase dramatically. The current is limited by internal 100 Ω resistors between the input pins and diodes to each supply. The output will remain low (no phase reversal) for inputs 1.3V below ground (V^-). If the output does not have to sink current, such as in a single supply system with a 1k load to ground, there is no phase reversal for inputs up to 8V below ground.

There are no clamps across the inputs of the LT1215/LT1216 and therefore each input can be forced to any voltage between the supplies. The input current will remain constant at about 360nA over most of this range. When an input gets closer than 2V to the positive supply, that input current will gradually decrease to zero until the input goes above the supply, then it will increase due to the previously mentioned diodes. If the inverting input is held more positive than the noninverting input by 200mV or more, while at the same time the noninverting input is within 300mV of ground (V^-), then the supply current will increase by 5mA and the noninverting input current will increase to about 100 μ A. This should be kept in mind in comparator applications where the inverting input stays above ground (V^-) and the noninverting input does not.

Output

The output of the LT1215/LT1216 will swing to within 0.61V of the positive supply with no load. The open-loop output resistance, when the output is driven hard into the positive rail, is about 100 Ω as the output starts to source

current; this resistance drops to about 20 Ω as the current increases. Therefore when the output sources 1mA, the output will swing to within 0.7V of the positive supply. While sourcing 30mA, it is within 1.25V of the positive supply.

The output of the LT1215/LT1216 will swing to within 5mV of the negative supply while sinking zero current. Thus, in a typical single supply application with the load going to ground, the output will go to within 5mV of ground. The open-loop output resistance when the output is driven hard into the negative rail is about 25 Ω at low currents and reduces to about 21 Ω at high currents. Therefore when the output sinks 1mA, the output is about 30mV above the negative supply and while sinking 30mA, it is about 630mV above it.

The output of the LT1215/LT1216 has reverse-biased diodes to each supply. If the output is forced beyond either supply, unlimited currents will flow. If the current is transient and limited to several hundred mA, no damage will occur.

Feedback Components

Because the input currents of the LT1215/LT1216 are less than 600nA, it is possible to use high value feedback resistors to set the gain. However, care must be taken to insure that the pole that is formed by the feedback resistors and the input capacitance does not degrade the stability of the amplifier. For example, if a single supply, noninverting gain of two is set with two 10k resistors, the LT1215/LT1216 will probably oscillate. This is because the amplifier goes open-loop at 7MHz (6dB of gain) and has 50° of phase margin. The feedback resistors and the 10pF input capacitance generate a pole at 3MHz that introduces 67° of phase shift at 7MHz! The solution is simple, lower the values of the resistors or add a feedback capacitor of 10pF or more.

APPLICATIONS INFORMATION

Comparator Applications

Sometimes it is desirable to use an op amp as a comparator. When operating the LT1215/LT1216 on a single 3.3V or 5V supply, the output interfaces directly with most TTL and CMOS logic.

The response time of the LT1215/LT1216 is a strong function of the amount of input overdrive as shown in the

following photos. These amplifiers are unity-gain stable op amps and not fast comparators, therefore, the logic being driven may oscillate due to the long transition time. The output can be speeded up by adding 20mV or more of hysteresis (positive feedback), but the offset is then a function of the input direction.

LT1215 Comparator Response (+)
20mV, 10mV, 5mV, 2mV Overdrives

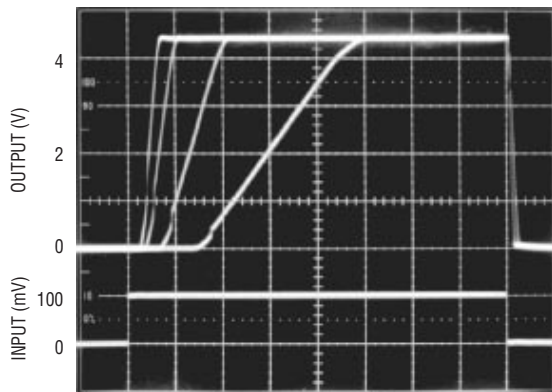

$V_S = 5V$
 $R_L = \infty$

1215/16 AI01

LT1215 Comparator Response (-)
20mV, 10mV, 5mV, 2mV Overdrives

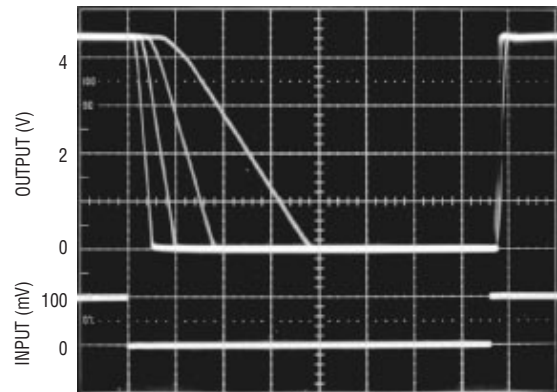

$V_S = 5V$
 $R_L = \infty$

1215/16 AI02

SIMPLIFIED SCHEMATIC

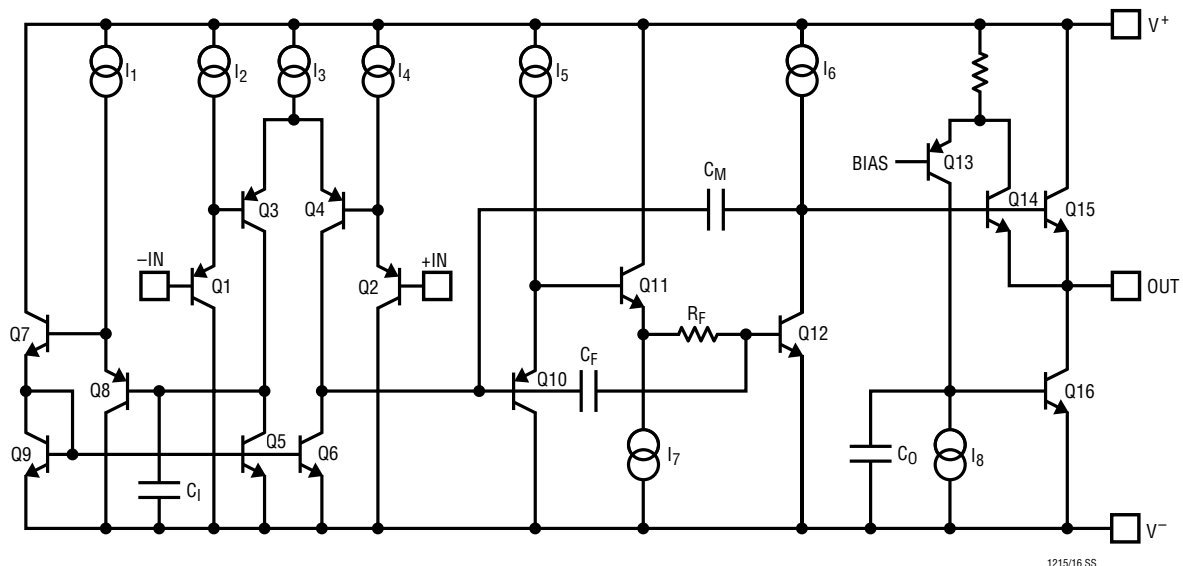

1215/16 SS

TYPICAL APPLICATION

Single Supply, AC Coupled Input, RMS Calibrated, Average Detector

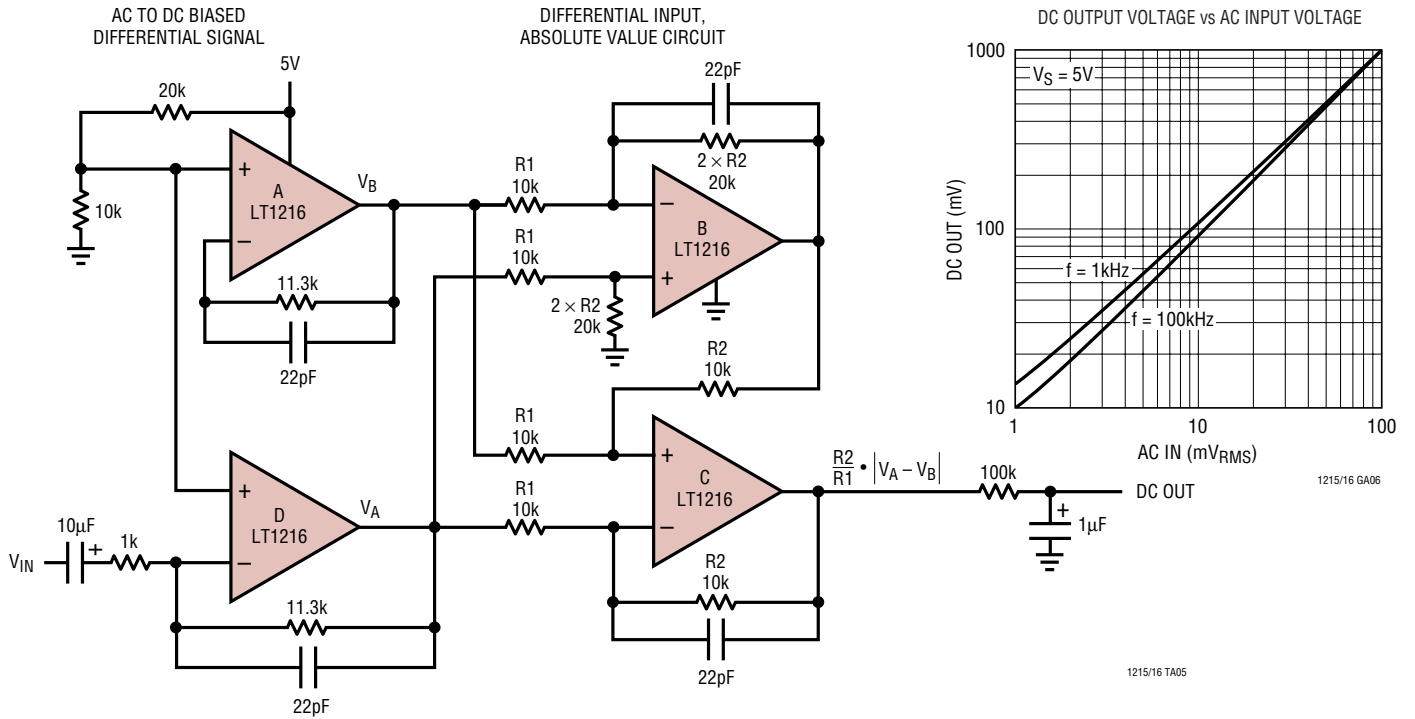

PACKAGE DESCRIPTION

Dimensions in inches (millimeters) unless otherwise noted.

J8 Package
8-Lead CERDIP (Narrow 0.300, Hermetic)
 (LTC DWG # 05-08-1110)

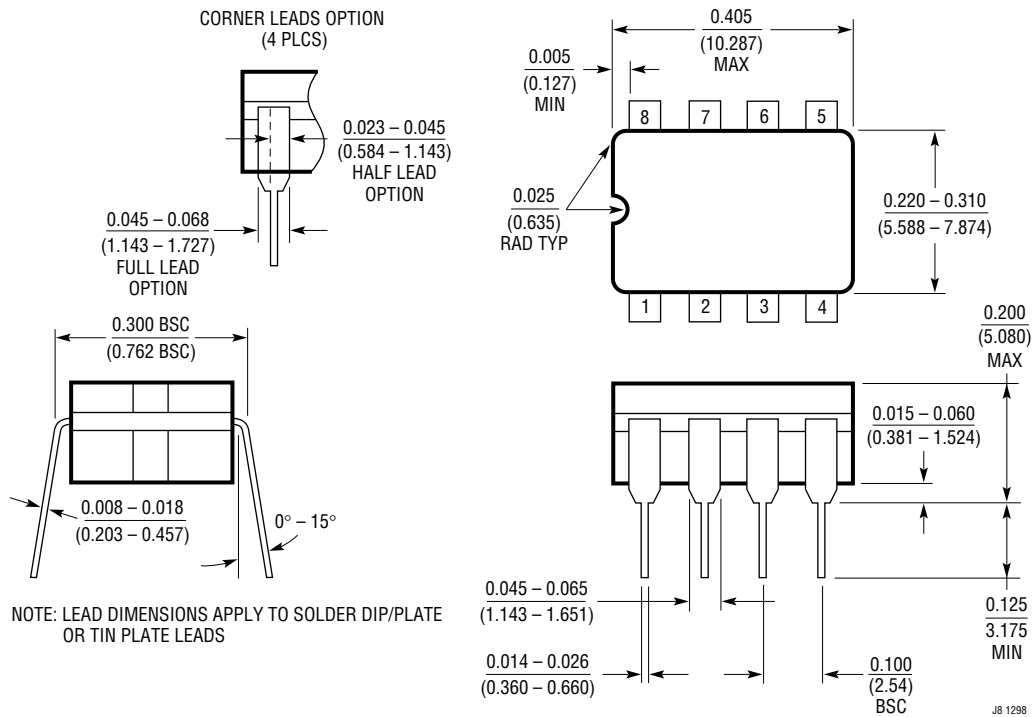

PACKAGE DESCRIPTION

Dimensions in inches (millimeters) unless otherwise noted.

N8 Package
8-Lead PDIP (Narrow 0.300)
 (LTC DWG # 05-08-1510)

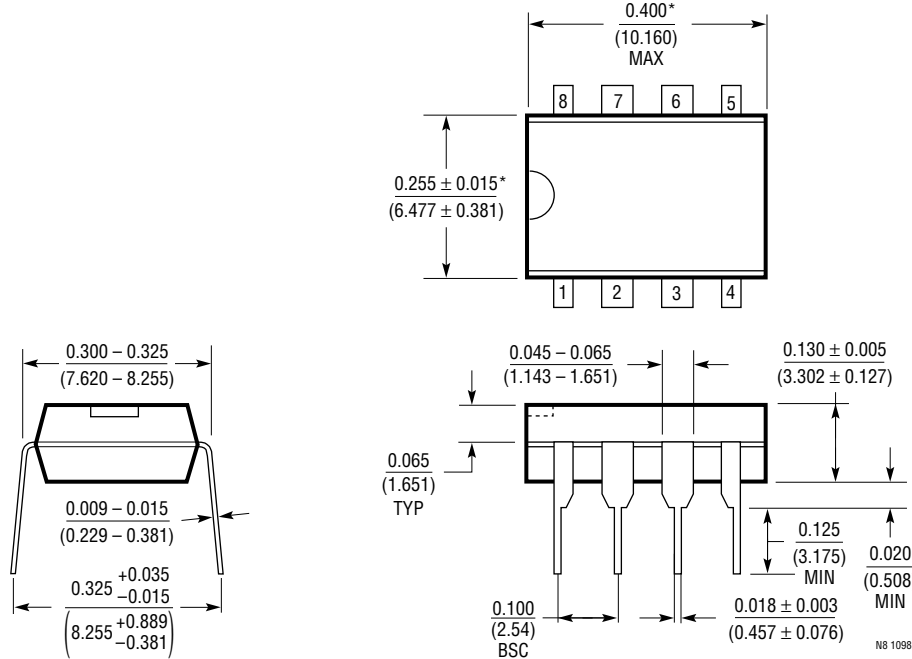

*THESE DIMENSIONS DO NOT INCLUDE MOLD FLASH OR PROTRUSIONS.
 MOLD FLASH OR PROTRUSIONS SHALL NOT EXCEED 0.010 INCH (0.254mm)

N Package
14-Lead PDIP (Narrow 0.300)
 (LTC DWG # 05-08-1510)

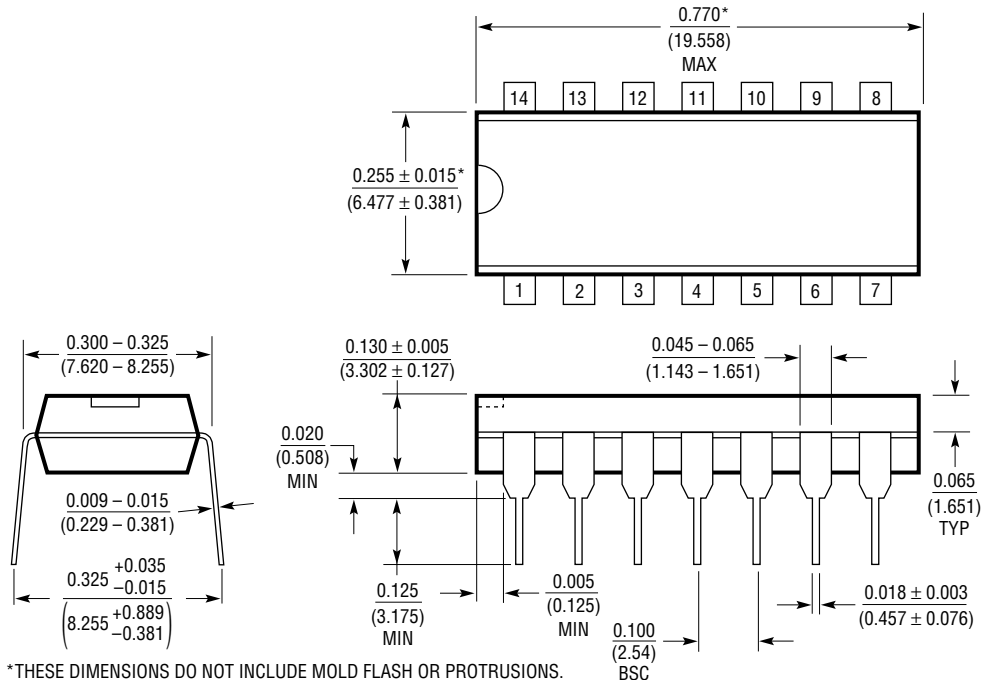

*THESE DIMENSIONS DO NOT INCLUDE MOLD FLASH OR PROTRUSIONS.
 MOLD FLASH OR PROTRUSIONS SHALL NOT EXCEED 0.010 INCH (0.254mm)

N14 1098

PACKAGE DESCRIPTION

Dimensions in inches (millimeters) unless otherwise noted.

S8 Package
8-Lead Plastic Small Outline (Narrow 0.150)
 (LTC DWG # 05-08-1610)

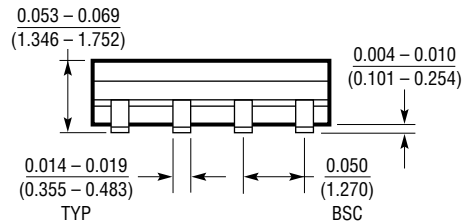
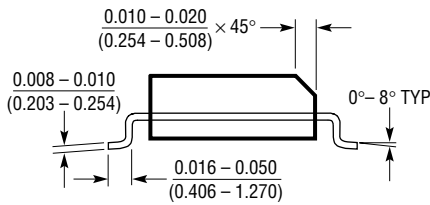
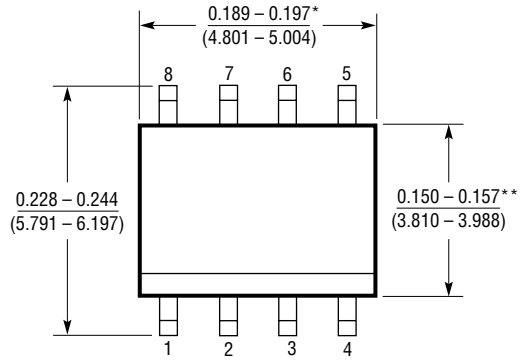

*DIMENSION DOES NOT INCLUDE MOLD FLASH. MOLD FLASH SHALL NOT EXCEED 0.006" (0.152mm) PER SIDE

**DIMENSION DOES NOT INCLUDE INTERLEAD FLASH. INTERLEAD FLASH SHALL NOT EXCEED 0.010" (0.254mm) PER SIDE

S08 1298

S Package
16-Lead Plastic Small Outline (Narrow 0.150)
 (LTC DWG # 05-08-1610)

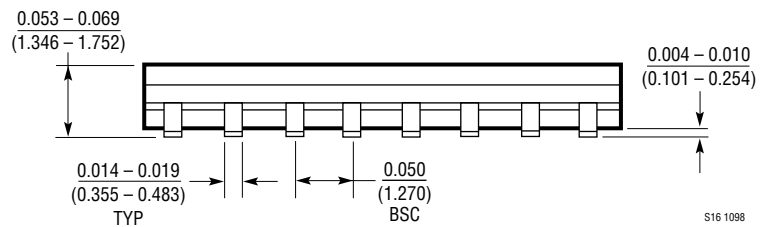
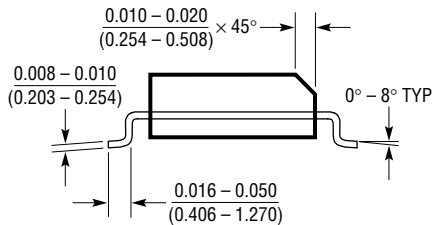
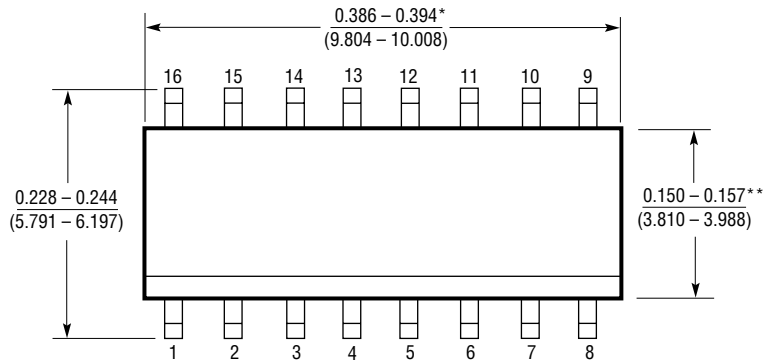

*DIMENSION DOES NOT INCLUDE MOLD FLASH. MOLD FLASH SHALL NOT EXCEED 0.006" (0.152mm) PER SIDE

**DIMENSION DOES NOT INCLUDE INTERLEAD FLASH. INTERLEAD FLASH SHALL NOT EXCEED 0.010" (0.254mm) PER SIDE

S16 1098

TYPICAL APPLICATION

LT1216 Photo Diode Amplifier

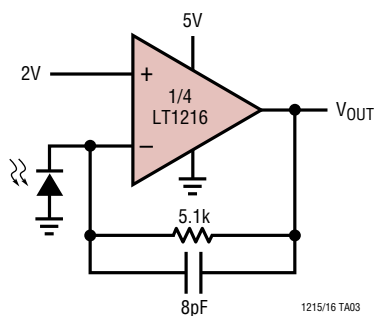

I TO V BANDWIDTH = 7MHz

TRANSIENT RESPONSE

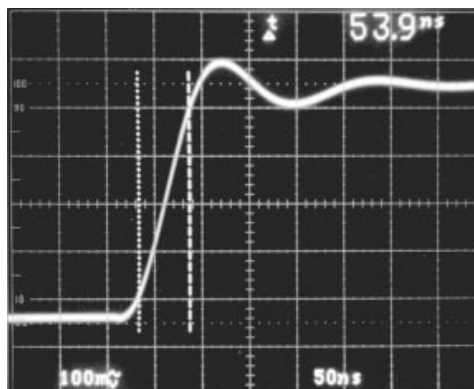

1215/16 TA05

RELATED PARTS

PART NUMBER	DESCRIPTION	COMMENTS
LT1211/LT1212	Dual/Quad 14MHz, 7V/μs Single Supply Precision Op Amps	Input Common Mode Includes Ground, 275μV V _{OS} (Max), 6μV/°C Max Drift, 1.8mA Max Supply Current per Amplifier
LT1213/LT1214	Dual/Quad 28MHz, 12V/μs Single Supply Precision Op Amps	Input Common Mode Includes Ground, 275μV V _{OS} (Max), 6μV/°C Max Drift, 3.5mA Max Supply Current per Amplifier
LT1498/LT1499	10MHz, 6V/μs, Dual/Quad Rail-to-Rail Input and Output Precision C-Load™ Op Amps	475μV V _{OS} (Max), 2.2mA Max Supply Current per Amplifier, 2.5μV/°C Max Drift, Stable with Capacitive Loads to 10,000pF
LT1124/LT1125	12.5MHz, 4.5V/μs, Dual/Quad Low Noise, High Speed Precision Op Amps	70μV V _{OS} (Max), 2.75mA Max Supply Current per Amplifier, 1μV/°C Max Drift
LT1355/LT1356	Dual and Quad 12MHz, 400V/μs Op Amps	1.25mA Max Supply Current per Amplifier, 800μV V _{OS} (Max), Drives All Capacitive Loads
LT1358/LT1359	Dual and Quad 25MHz, 600V/μs Op Amps	2.5mA Max Supply Current per Amplifier, 600μV V _{OS} (Max), Drives All Capacitive Loads
LT1361/LT1362	Dual and Quad 50MHz, 800V/μs Op Amps	5mA Max Supply Current per Amplifier, 1mV V _{OS} (Max), Drives All Capacitive Loads

C-Load is a trademark of Linear Technology Corporation.