

FEATURES

- Rail-to-Rail Input and Output
- 100% Tested Low Voltage Noise:
 $3.2\text{nV}/\sqrt{\text{Hz}}$ Typ at 1kHz
 $4.5\text{nV}/\sqrt{\text{Hz}}$ Max at 1kHz
- Offset Voltage: $60\mu\text{V}$ Max
- Low V_{OS} Drift: $0.2\mu\text{V}/^\circ\text{C}$ Typ
- Low Input Bias Current: 20nA Max
- Wide Supply Range: 3V to $\pm 18\text{V}$
- High A_{VOL} : $7\text{V}/\mu\text{V}$ Min, $R_L = 10\text{k}$
- High CMRR: 109dB Min
- High PSRR: 108dB Min
- Gain Bandwidth Product: 7.2MHz
- Slew Rate: $2.5\text{V}/\mu\text{s}$
- Operating Temperature Range: -40°C to 85°C

APPLICATIONS

- Low Noise Signal Processing
- Microvolt Accuracy Threshold Detection
- Strain Gauge Amplifiers
- Tape Head Preamplifiers
- Direct Coupled Audio Gain Stages
- Infrared Detectors
- Battery-Powered Microphones

DESCRIPTION

The LT[®]1677 features the lowest noise performance available for a rail-to-rail operational amplifier: $3.2\text{nV}/\sqrt{\text{Hz}}$ wideband noise, 1/f corner frequency of 13Hz and 90nV peak-to-peak 0.1Hz to 10Hz noise. Low noise is combined with outstanding precision: $20\mu\text{V}$ offset voltage and $0.2\mu\text{V}/^\circ\text{C}$ drift, 130dB common mode and power supply rejection and 7.2MHz gain bandwidth product. The common mode range exceeds the power supply by 100mV.

The voltage gain of the LT1677 is extremely high, 19 million (typical) driving a 10k load.

In the design, processing and testing of the device, particular attention has been paid to the optimization of the entire distribution of several key parameters. Consequently, the specifications have been spectacularly improved compared to competing rail-to-rail amplifiers.

LT, LT, LTC and LTM are registered trademarks of Linear Technology Corporation. All other trademarks are the property of their respective owners.

TYPICAL APPLICATION

3V Electret Microphone Amplifier

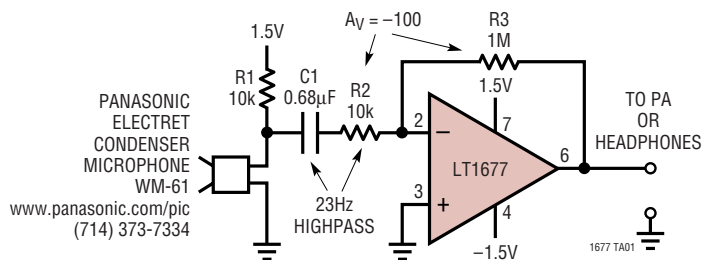

Distribution of Offset Voltage

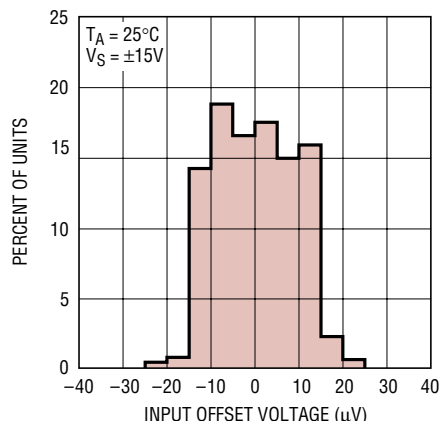

1677 TA02

1677fa

ABSOLUTE MAXIMUM RATINGS

(Note 1)

Supply Voltage	±22V
Input Voltages (Note 2)	0.3V Beyond Either Rail
Differential Input Current (Note 2)	±25mA
Output Short-Circuit Duration (Note 3)	Indefinite
Storage Temperature Range	-65°C to 150°C
Lead Temperature (Soldering, 10 sec.)	300°C
Operating Temperature Range	
LT1677C (Note 4)	-40°C to 85°C
LT1677I	-40°C to 85°C
Specified Temperature Range	
LT1677C (Note 5)	-40°C to 85°C
LT1677I	-40°C to 85°C

PACKAGE/ORDER INFORMATION

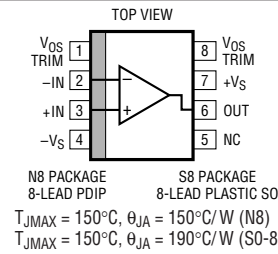
	
ORDER PART NUMBER	S8 PART MARKING
LT1677CS8	1677
LT1677IS8	1677I
LT1677CN8	
LT1677IN8	
Order Options Tape and Reel: Add #TR Lead Free: Add #PBF Lead Free Tape and Reel: Add #TRPBF Lead Free Part Marking: http://www.linear.com/leadfree/	

Consult LTC Marketing for parts specified with wider operating temperature ranges.

ELECTRICAL CHARACTERISTICS

The ● denotes the specifications which apply over the full operating temperature range, otherwise specifications are at $T_A = 25^\circ\text{C}$. $V_S = 3\text{V}$, $V_{CM} = V_O = 1.7\text{V}$; $V_S = 5\text{V}$, $V_{CM} = V_O = 2.5\text{V}$ unless otherwise noted.

SYMBOL	PARAMETER	CONDITIONS (Note 6)	MIN	TYP	MAX	UNITS
V_{OS}	Input Offset Voltage (Note 11)	$0^\circ\text{C} \leq T_A \leq 70^\circ\text{C}$	●	35	90	μV
		$-40^\circ\text{C} \leq T_A \leq 85^\circ\text{C}$	●	55	150	μV
				75	210	μV
		$V_{CM} = V_S + 0.1\text{V}$		150	400	μV
		$V_{CM} = V_S - 0.2\text{V}$, $0^\circ\text{C} \leq T_A \leq 70^\circ\text{C}$	●	180	550	μV
	$V_{CM} = V_S - 0.3\text{V}$, $-40^\circ\text{C} \leq T_A \leq 85^\circ\text{C}$	●	200	650	μV	
	$V_{CM} = -0.1\text{V}$		1.5	5.0	mV	
	$V_{CM} = 0\text{V}$, $0^\circ\text{C} \leq T_A \leq 70^\circ\text{C}$	●	1.8	6.0	mV	
	$V_{CM} = 0\text{V}$, $-40^\circ\text{C} \leq T_A \leq 85^\circ\text{C}$	●	2.0	6.5	mV	
$\frac{\Delta V_{OS}}{\Delta \text{Temp}}$	Average Input Offset Drift (Note 10)	SO-8	●	0.40	2.0	$\mu\text{V}/^\circ\text{C}$
		N8	●	0.20	1.5	$\mu\text{V}/^\circ\text{C}$
$\frac{\Delta V_{OS}}{\Delta \text{Time}}$	Long Term Input Voltage Stability			0.3		$\mu\text{V}/\text{Mo}$
I_B	Input Bias Current (Note 11)	$0^\circ\text{C} \leq T_A \leq 70^\circ\text{C}$	●	±2	±20	nA
		$-40^\circ\text{C} \leq T_A \leq 85^\circ\text{C}$	●	±3	±35	nA
				±7	±50	nA
		$V_{CM} = V_S + 0.1\text{V}$		0.19	0.40	μA
		$V_{CM} = V_S - 0.2\text{V}$, $0^\circ\text{C} \leq T_A \leq 70^\circ\text{C}$	●	0.19	0.60	μA
	$V_{CM} = V_S - 0.3\text{V}$, $-40^\circ\text{C} \leq T_A \leq 85^\circ\text{C}$	●	0.25	0.75	μA	
	$V_{CM} = -0.1\text{V}$		-1.2	-0.41	μA	
	$V_{CM} = 0\text{V}$, $0^\circ\text{C} \leq T_A \leq 70^\circ\text{C}$	●	-2.0	-0.45	μA	
	$V_{CM} = 0\text{V}$, $-40^\circ\text{C} \leq T_A \leq 85^\circ\text{C}$	●	-2.3	-0.47	μA	
I_{OS}	Input Offset Current (Note 11)	$0^\circ\text{C} \leq T_A \leq 70^\circ\text{C}$	●	4	15	nA
		$-40^\circ\text{C} \leq T_A \leq 85^\circ\text{C}$	●	5	20	nA
				8	40	nA
		$V_{CM} = V_S + 0.1\text{V}$		6	30	nA
		$V_{CM} = V_S - 0.2\text{V}$, $0^\circ\text{C} \leq T_A \leq 70^\circ\text{C}$	●	10	40	nA
	$V_{CM} = V_S - 0.3\text{V}$, $-40^\circ\text{C} \leq T_A \leq 85^\circ\text{C}$	●	15	65	nA	
	$V_{CM} = -0.1\text{V}$		20	100	nA	
	$V_{CM} = 0\text{V}$, $0^\circ\text{C} \leq T_A \leq 70^\circ\text{C}$	●	25	150	nA	
	$V_{CM} = 0\text{V}$, $-40^\circ\text{C} \leq T_A \leq 85^\circ\text{C}$	●	30	160	nA	

1677fa

ELECTRICAL CHARACTERISTICS The ● denotes the specifications which apply over the full operating temperature range, otherwise specifications are at $T_A = 25^\circ\text{C}$. $V_S = 3\text{V}$, $V_{CM} = V_O = 1.7\text{V}$; $V_S = 5\text{V}$, $V_{CM} = V_O = 2.5\text{V}$ unless otherwise noted.

SYMBOL	PARAMETER	CONDITIONS (Note 6)	MIN	TYP	MAX	UNITS	
e_n	Input Noise Voltage	0.1Hz to 10Hz (Note 7) $V_{CM} = V_S$ $V_{CM} = 0\text{V}$		90 180 600		nV _{p-p} nV _{p-p} nV _{p-p}	
		Input Noise Voltage Density (Note 8)	$f_0 = 10\text{Hz}$ $V_{CM} = V_S$, $f_0 = 10\text{Hz}$ $V_{CM} = 0\text{V}$, $f_0 = 10\text{Hz}$		5.2 7 25		nV/ $\sqrt{\text{Hz}}$ nV/ $\sqrt{\text{Hz}}$ nV/ $\sqrt{\text{Hz}}$
i_n	Input Noise Current Density	$f_0 = 1\text{kHz}$ $V_{CM} = V_S$, $f_0 = 1\text{kHz}$ $V_{CM} = 0\text{V}$, $f_0 = 1\text{kHz}$		3.2 5.3 17	4.5	nV/ $\sqrt{\text{Hz}}$ nV/ $\sqrt{\text{Hz}}$ nV/ $\sqrt{\text{Hz}}$	
		$f_0 = 10\text{Hz}$ $f_0 = 1\text{kHz}$		1.2 0.3		pA/ $\sqrt{\text{Hz}}$ pA/ $\sqrt{\text{Hz}}$	
V_{CM}	Input Voltage Range	$0^\circ\text{C} \leq T_A \leq 70^\circ\text{C}$	●	-0.1 0	$V_S + 0.1\text{V}$ $V_S - 0.2\text{V}$	V V	
		$-40^\circ\text{C} \leq T_A \leq 85^\circ\text{C}$	●	0	$V_S - 0.3\text{V}$	V	
R_{IN}	Input Resistance	Common Mode		2		G Ω	
C_{IN}	Input Capacitance			4.2		pF	
CMRR	Common Mode Rejection Ratio (Note 11)	$V_S = 3\text{V}$ $V_{CM} = -0.1\text{V}$ to 3.1V $V_{CM} = 0\text{V}$ to 2.7V	●	55 53	68 67	dB dB	
		$V_S = 5\text{V}$ $V_{CM} = -0.1\text{V}$ to 5.1V $V_{CM} = 0\text{V}$ to 4.7V	●	60 58	73 72	dB dB	
PSRR	Power Supply Rejection Ratio	$V_S = 2.7\text{V}$ to 40V, $V_{CM} = V_O = 1.7\text{V}$ $V_S = 3.1\text{V}$ to 40V, $V_{CM} = V_O = 1.7\text{V}$	●	108 105	125 120	dB dB	
A_{VOL}	Large-Signal Voltage Gain	$V_S = 3\text{V}$, $R_L \geq 10\text{k}$, $V_O = 2.5\text{V}$ to 0.7V $0^\circ\text{C} \leq T_A \leq 70^\circ\text{C}$ $-40^\circ\text{C} \leq T_A \leq 85^\circ\text{C}$	● ● ●	0.6 0.4 0.4	4 3 3	V/ μV V/ μV V/ μV	
		$V_S = 3\text{V}$, $R_L \geq 2\text{k}$, $V_O = 2.2\text{V}$ to 0.7V $0^\circ\text{C} \leq T_A \leq 70^\circ\text{C}$ $-40^\circ\text{C} \leq T_A \leq 85^\circ\text{C}$	● ● ●	0.5 0.4 0.4	1 0.9 0.8	V/ μV V/ μV V/ μV	
		$V_S = 3\text{V}$, $R_L \geq 600\Omega$, $V_O = 2.2\text{V}$ to 0.7V $0^\circ\text{C} \leq T_A \leq 70^\circ\text{C}$ $-40^\circ\text{C} \leq T_A \leq 85^\circ\text{C}$	● ● ●	0.20 0.15 0.10	0.43 0.40 0.35	V/ μV V/ μV V/ μV	
		$V_S = 5\text{V}$, $R_L \geq 10\text{k}$, $V_O = 4.5\text{V}$ to 0.7V $0^\circ\text{C} \leq T_A \leq 70^\circ\text{C}$ $-40^\circ\text{C} \leq T_A \leq 85^\circ\text{C}$	● ● ●	0.8 0.7 0.7	5 4 4	V/ μV V/ μV V/ μV	
		$V_S = 5\text{V}$, $R_L \geq 2\text{k}$, $V_O = 4.2\text{V}$ to 0.7V $0^\circ\text{C} \leq T_A \leq 70^\circ\text{C}$ $-40^\circ\text{C} \leq T_A \leq 85^\circ\text{C}$	● ● ●	0.40 0.35 0.25	0.9 0.8 0.6	V/ μV V/ μV V/ μV	
		$V_S = 5\text{V}$, $R_L \geq 600\Omega$, $V_O = 4.2\text{V}$ to 0.7V $0^\circ\text{C} \leq T_A \leq 70^\circ\text{C}$ $-40^\circ\text{C} \leq T_A \leq 85^\circ\text{C}$	● ● ●	0.35 0.30 0.20	0.67 0.60 0.45	V/ μV V/ μV V/ μV	

ELECTRICAL CHARACTERISTICS The ● denotes the specifications which apply over the full operating temperature range, otherwise specifications are at $T_A = 25^\circ\text{C}$. $V_S = 3\text{V}$, $V_{CM} = V_O = 1.7\text{V}$; $V_S = 5\text{V}$, $V_{CM} = V_O = 2.5\text{V}$ unless otherwise noted.

SYMBOL	PARAMETER	CONDITIONS (Note 6)	MIN	TYP	MAX	UNITS
V_{OL}	Output Voltage Swing Low (Note 11)	Above GND $I_{SINK} = 0.1\text{mA}$ $0^\circ\text{C} \leq T_A \leq 70^\circ\text{C}$ $-40^\circ\text{C} \leq T_A \leq 85^\circ\text{C}$	●	110	170	mV
			●	125	200	mV
			●	130	230	mV
		Above GND $I_{SINK} = 2.5\text{mA}$ $0^\circ\text{C} \leq T_A \leq 70^\circ\text{C}$ $-40^\circ\text{C} \leq T_A \leq 85^\circ\text{C}$	●	170	250	mV
			●	195	320	mV
			●	205	350	mV
		Above GND $I_{SINK} = 10\text{mA}$ $0^\circ\text{C} \leq T_A \leq 70^\circ\text{C}$ $-40^\circ\text{C} \leq T_A \leq 85^\circ\text{C}$	●	370	500	mV
			●	440	600	mV
			●	465	650	mV
V_{OH}	Output Voltage Swing High (Note 11)	Below V_S $I_{SOURCE} = 0.1\text{mA}$ $0^\circ\text{C} \leq T_A \leq 70^\circ\text{C}$ $-40^\circ\text{C} \leq T_A \leq 85^\circ\text{C}$	●	75	170	mV
			●	85	200	mV
			●	93	250	mV
		Below V_S $I_{SOURCE} = 2.5\text{mA}$ $0^\circ\text{C} \leq T_A \leq 70^\circ\text{C}$ $-40^\circ\text{C} \leq T_A \leq 85^\circ\text{C}$	●	170	300	mV
			●	195	350	mV
			●	205	375	mV
		Below V_S $I_{SOURCE} = 10\text{mA}$ $0^\circ\text{C} \leq T_A \leq 70^\circ\text{C}$ $-40^\circ\text{C} \leq T_A \leq 85^\circ\text{C}$	●	450	700	mV
			●	510	800	mV
			●	525	850	mV
I_{SC}	Output Short-Circuit Current (Note 3)	$V_S = 3\text{V}$ $0^\circ\text{C} \leq T_A \leq 70^\circ\text{C}$ $-40^\circ\text{C} \leq T_A \leq 85^\circ\text{C}$	●	15	22	mA
			●	14	20	mA
			●	13	19	mA
		$V_S = 5\text{V}$ $0^\circ\text{C} \leq T_A \leq 70^\circ\text{C}$ $-40^\circ\text{C} \leq T_A \leq 85^\circ\text{C}$	●	20	29	mA
			●	18	27	mA
			●	17	25	mA
SR	Slew Rate (Note 13)	$A_V = -1$ $R_L \geq 10\text{k}$, $0^\circ\text{C} \leq T_A \leq 70^\circ\text{C}$ $R_L \geq 10\text{k}$, $-40^\circ\text{C} \leq T_A \leq 85^\circ\text{C}$	●	1.7	2.5	V/ μs
			●	1.5	2.3	V/ μs
			●	1.2	2.0	V/ μs
GBW	Gain Bandwidth Product (Note 11)	$f_0 = 100\text{kHz}$ $f_0 = 100\text{kHz}$, $0^\circ\text{C} \leq T_A \leq 70^\circ\text{C}$ $f_0 = 100\text{kHz}$, $-40^\circ\text{C} \leq T_A \leq 85^\circ\text{C}$	●	4.5	7.2	MHz
			●	3.8	6.2	MHz
			●	3.7	5.8	MHz
t_s	Settling Time	2V Step 0.1%, $A_V = +1$ 2V Step 0.01%, $A_V = +1$		2.1		μs
				3.5		μs
R_O	Open-Loop Output Resistance Closed-Loop Output Resistance	$I_{OUT} = 0$		80		Ω
		$A_V = 100$, $f = 10\text{kHz}$		1		Ω
I_S	Supply Current (Note 12)	$0^\circ\text{C} \leq T_A \leq 70^\circ\text{C}$ $-40^\circ\text{C} \leq T_A \leq 85^\circ\text{C}$	●	2.60	3.4	mA
			●	2.75	3.7	mA
			●	2.80	3.8	mA

ELECTRICAL CHARACTERISTICS The ● denotes the specifications which apply over the full operating temperature range, otherwise specifications are at $T_A = 25^\circ\text{C}$. $V_S = \pm 15\text{V}$, $V_{CM} = V_O = 0\text{V}$ unless otherwise noted.

SYMBOL	PARAMETER	CONDITIONS (Note 6)	MIN	TYP	MAX	UNITS
V_{OS}	Input Offset Voltage	$0^\circ\text{C} \leq T_A \leq 70^\circ\text{C}$	●	20	60	μV
		$-40^\circ\text{C} \leq T_A \leq 85^\circ\text{C}$	●	30	120	μV
				45	180	μV
		$V_{CM} = 15.1\text{V}$		150	400	μV
		$V_{CM} = 14.8\text{V}$, $0^\circ\text{C} \leq T_A \leq 70^\circ\text{C}$	●	180	550	μV
	$V_{CM} = 14.7\text{V}$, $-40^\circ\text{C} \leq T_A \leq 85^\circ\text{C}$	●	200	650	μV	
	$V_{CM} = -15.1\text{V}$		1.5	5.0	mV	
	$V_{CM} = -15\text{V}$, $0^\circ\text{C} \leq T_A \leq 70^\circ\text{C}$	●	1.8	6.0	mV	
	$V_{CM} = -15\text{V}$, $-40^\circ\text{C} \leq T_A \leq 85^\circ\text{C}$	●	2.0	6.5	mV	
$\frac{\Delta V_{OS}}{\Delta \text{Temp}}$	Average Input Offset Drift (Note 10)	SO-8	●	0.40	2.0	$\mu\text{V}/^\circ\text{C}$
		N8	●	0.20	1.5	$\mu\text{V}/^\circ\text{C}$
$\frac{\Delta V_{OS}}{\Delta \text{Time}}$	Long Term Input Voltage Stability			0.3		$\mu\text{V}/\text{Mo}$
I_B	Input Bias Current	$0^\circ\text{C} \leq T_A \leq 70^\circ\text{C}$	●	± 2	± 20	nA
		$-40^\circ\text{C} \leq T_A \leq 85^\circ\text{C}$	●	± 3	± 35	nA
				± 7	± 50	nA
		$V_{CM} = 15.1\text{V}$		0.19	0.40	μA
		$V_{CM} = 14.8\text{V}$, $0^\circ\text{C} \leq T_A \leq 70^\circ\text{C}$	●	0.20	0.60	μA
	$V_{CM} = 14.7\text{V}$, $-40^\circ\text{C} \leq T_A \leq 85^\circ\text{C}$	●	0.25	0.75	μA	
	$V_{CM} = -15.1\text{V}$		-1.2	-0.42	μA	
	$V_{CM} = -15\text{V}$, $0^\circ\text{C} \leq T_A \leq 70^\circ\text{C}$	●	-2.0	-0.46	μA	
	$V_{CM} = -15\text{V}$, $-40^\circ\text{C} \leq T_A \leq 85^\circ\text{C}$	●	-2.3	-0.48	μA	
I_{OS}	Input Offset Current	$0^\circ\text{C} \leq T_A \leq 70^\circ\text{C}$	●	3	15	nA
		$-40^\circ\text{C} \leq T_A \leq 85^\circ\text{C}$	●	5	20	nA
				8	40	nA
		$V_{CM} = 15.1\text{V}$		5	25	nA
		$V_{CM} = 14.8\text{V}$, $0^\circ\text{C} \leq T_A \leq 70^\circ\text{C}$	●	8	35	nA
	$V_{CM} = 14.7\text{V}$, $-40^\circ\text{C} \leq T_A \leq 85^\circ\text{C}$	●	12	60	nA	
	$V_{CM} = -15.1\text{V}$		20	105	nA	
	$V_{CM} = -15\text{V}$, $0^\circ\text{C} \leq T_A \leq 70^\circ\text{C}$	●	25	160	nA	
	$V_{CM} = -15\text{V}$, $-40^\circ\text{C} \leq T_A \leq 85^\circ\text{C}$	●	30	170	nA	
e_n	Input Noise Voltage	0.1Hz to 10Hz (Note 7)		90		nV _{p-p}
		$V_{CM} = 15\text{V}$		180		nV _{p-p}
		$V_{CM} = -15\text{V}$		600		nV _{p-p}
	Input Noise Voltage Density	$f_0 = 10\text{Hz}$		5.2		nV/ $\sqrt{\text{Hz}}$
		$V_{CM} = 15\text{V}$, $f_0 = 10\text{Hz}$		7		nV/ $\sqrt{\text{Hz}}$
		$V_{CM} = -15\text{V}$, $f_0 = 10\text{Hz}$		25		nV/ $\sqrt{\text{Hz}}$
		$f_0 = 1\text{kHz}$		3.2	4.5	nV/ $\sqrt{\text{Hz}}$
		$V_{CM} = 15\text{V}$, $f_0 = 1\text{kHz}$		5.3		nV/ $\sqrt{\text{Hz}}$
	$V_{CM} = -15\text{V}$, $f_0 = 1\text{kHz}$		17		nV/ $\sqrt{\text{Hz}}$	
i_n	Input Noise Current Density	$f_0 = 10\text{Hz}$		1.2		pA/ $\sqrt{\text{Hz}}$
		$f_0 = 1\text{kHz}$		0.3		pA/ $\sqrt{\text{Hz}}$
V_{CM}	Input Voltage Range	$0^\circ\text{C} \leq T_A \leq 70^\circ\text{C}$	●	-15.1	15.1	V
		$-40^\circ\text{C} \leq T_A \leq 85^\circ\text{C}$	●	-15.0	14.8	V
				-15.0	14.7	V
R_{IN}	Input Resistance	Common Mode		2		G Ω
C_{IN}	Input Capacitance			4.2		pF

ELECTRICAL CHARACTERISTICS The ● denotes the specifications which apply over the full operating temperature range, otherwise specifications are at $T_A = 25^\circ\text{C}$. $V_S = \pm 15\text{V}$, $V_{CM} = V_O = 0\text{V}$ unless otherwise noted.

SYMBOL	PARAMETER	CONDITIONS (Note 6)	MIN	TYP	MAX	UNITS		
CMRR	Common Mode Rejection Ratio	$V_{CM} = -13.3\text{V to } 14\text{V}$	109	130		dB		
			105	124		dB		
		$V_{CM} = -15.1\text{V to } 15.1\text{V}$ $V_{CM} = -15\text{V to } 14.7\text{V}$	74	95		dB		
PSRR	Power Supply Rejection Ratio	$V_S = \pm 1.7\text{V to } \pm 18\text{V}$	106	130		dB		
			103	125		dB		
		$V_S = 2.7\text{V to } 40\text{V}$ $V_S = 3.1\text{V to } 40\text{V}$	108	125		dB		
A _{VOL}	Large-Signal Voltage Gain	$R_L \geq 10\text{k}$, $V_O = \pm 14\text{V}$ $0^\circ\text{C} \leq T_A \leq 70^\circ\text{C}$ $-40^\circ\text{C} \leq T_A \leq 85^\circ\text{C}$	7	19		V/ μV		
			4	13		V/ μV		
			3	8		V/ μV		
A _{VOL}	Large-Signal Voltage Gain	$R_L \geq 2\text{k}$, $V_O = \pm 13.5\text{V}$ $0^\circ\text{C} \leq T_A \leq 70^\circ\text{C}$ $-40^\circ\text{C} \leq T_A \leq 85^\circ\text{C}$	0.50	0.75		V/ μV		
			0.30	0.67		V/ μV		
			0.15	0.24		V/ μV		
A _{VOL}	Large-Signal Voltage Gain	$R_L \geq 600\Omega$, $V_O = \pm 10\text{V}$	0.2	0.5		V/ μV		
V _{OL}	Output Voltage Swing Low	Above $-V_S$ $I_{SINK} = 0.1\text{mA}$ $0^\circ\text{C} \leq T_A \leq 70^\circ\text{C}$ $-40^\circ\text{C} \leq T_A \leq 85^\circ\text{C}$		110	170	mV		
				125	200	mV		
				130	230	mV		
		Above $-V_S$ $I_{SINK} = 2.5\text{mA}$ $0^\circ\text{C} \leq T_A \leq 70^\circ\text{C}$ $-40^\circ\text{C} \leq T_A \leq 85^\circ\text{C}$		170	250	mV		
				195	320	mV		
				205	350	mV		
V _{OL}	Output Voltage Swing Low	Above $-V_S$ $I_{SINK} = 10\text{mA}$ $0^\circ\text{C} \leq T_A \leq 70^\circ\text{C}$ $-40^\circ\text{C} \leq T_A \leq 85^\circ\text{C}$		370	500	mV		
				440	600	mV		
				450	650	mV		
		V _{OH}	Output Voltage Swing High	Below $+V_S$ $I_{SOURCE} = 0.1\text{mA}$ $0^\circ\text{C} \leq T_A \leq 70^\circ\text{C}$ $-40^\circ\text{C} \leq T_A \leq 85^\circ\text{C}$		110	170	mV
						130	200	mV
						140	250	mV
V _{OH}	Output Voltage Swing High	Below $+V_S$ $I_{SOURCE} = 2.5\text{mA}$ $0^\circ\text{C} \leq T_A \leq 70^\circ\text{C}$ $-40^\circ\text{C} \leq T_A \leq 85^\circ\text{C}$		210	300	mV		
				240	350	mV		
				250	375	mV		
V _{OH}	Output Voltage Swing High	Below $+V_S$ $I_{SOURCE} = 10\text{mA}$ $0^\circ\text{C} \leq T_A \leq 70^\circ\text{C}$ $-40^\circ\text{C} \leq T_A \leq 85^\circ\text{C}$		520	700	mV		
				590	800	mV		
				620	850	mV		
I _{SC}	Output Short-Circuit Current (Note 3)	$0^\circ\text{C} \leq T_A \leq 70^\circ\text{C}$	25	35		mA		
			20	30		mA		
		$-40^\circ\text{C} \leq T_A \leq 85^\circ\text{C}$	18	28		mA		
SR	Slew Rate	$R_L \geq 10\text{k}$ (Note 9)	1.7	2.5		V/ μs		
		$R_L \geq 10\text{k}$ (Note 9) $0^\circ\text{C} \leq T_A \leq 70^\circ\text{C}$	1.5	2.3		V/ μs		
		$R_L \geq 10\text{k}$ (Note 9) $-40^\circ\text{C} \leq T_A \leq 85^\circ\text{C}$	1.2	2.0		V/ μs		
GBW	Gain Bandwidth Product	$f_0 = 100\text{kHz}$	4.5	7.2		MHz		
		$f_0 = 100\text{kHz}$, $0^\circ\text{C} \leq T_A \leq 70^\circ\text{C}$	3.8	6.2		MHz		
		$f_0 = 100\text{kHz}$, $-40^\circ\text{C} \leq T_A \leq 85^\circ\text{C}$	3.7	5.8		MHz		

ELECTRICAL CHARACTERISTICS

The ● denotes the specifications which apply over the full operating temperature range, otherwise specifications are at $T_A = 25^\circ\text{C}$. $V_S = \pm 15\text{V}$, $V_{CM} = V_O = 0\text{V}$ unless otherwise noted.

SYMBOL	PARAMETER	CONDITIONS (Note 6)	MIN	TYP	MAX	UNITS
THD	Total Harmonic Distortion	$R_L = 2\text{k}$, $A_V = 1$, $f_0 = 1\text{kHz}$, $V_O = 10\text{V}_{P-P}$		0.0006		%
t_S	Settling Time	10V Step 0.1%, $A_V = +1$ 10V Step 0.01%, $A_V = +1$		5 6		μs μs
R_O	Open-Loop Output Resistance Closed-Loop Output Resistance	$I_{OUT} = 0$ $A_V = 100$, $f = 10\text{kHz}$		80 1		Ω Ω
I_S	Supply Current	$0^\circ\text{C} \leq T_A \leq 70^\circ\text{C}$ $-40^\circ\text{C} \leq T_A \leq 85^\circ\text{C}$	● ●	2.75 3.00 3.10	3.5 3.9 4.0	mA mA mA

Note 1: Stresses beyond those listed under Absolute Maximum Ratings may cause permanent damage to the device. Exposure to any Absolute Maximum Rating condition for extended periods may affect device reliability and lifetime.

Note 2: The inputs are protected by back-to-back diodes. Current limiting resistors are not used in order to achieve low noise. If differential input voltage exceeds $\pm 1.4\text{V}$, the input current should be limited to 25mA. If the common mode range exceeds either rail, the input current should be limited to 10mA.

Note 3: A heat sink may be required to keep the junction temperature below absolute maximum.

Note 4: The LT1677C and LT1677I are guaranteed functional over the Operating Temperature Range of -40°C to 85°C .

Note 5: The LT1677C is guaranteed to meet specified performance from 0°C to 70°C . The LT1677C is designed, characterized and expected to meet specified performance from -40°C to 85°C but is not tested or QA sampled at these temperatures. The LT1677I is guaranteed to meet specified performance from -40°C to 85°C .

Note 6: Typical parameters are defined as the 60% yield of parameter distributions of individual amplifier; i.e., out of 100 LT1677s, typically 60 op amps will be better than the indicated specification.

Note 7: See the test circuit and frequency response curve for 0.1Hz to 10Hz tester in the Applications Information section of the LT1677 data sheet.

Note 8: Noise is 100% tested at $\pm 15\text{V}$ supplies.

Note 9: Slew rate is measured in $A_V = -1$; input signal is $\pm 7.5\text{V}$, output measured at $\pm 2.5\text{V}$.

Note 10: This parameter is not 100% tested. $V_S = 3\text{V}$ and 5V limits are guaranteed by correlation to $V_S = \pm 15\text{V}$ test.

Note 11: $V_S = 5\text{V}$ limits are guaranteed by correlation to $V_S = 3\text{V}$ and $V_S = \pm 15\text{V}$ tests.

Note 12: $V_S = 3\text{V}$ limits are guaranteed by correlation to $V_S = 5\text{V}$ and $V_S = \pm 15\text{V}$ tests.

Note 13: Guaranteed by correlation to slew rate at $V_S = \pm 15\text{V}$ and GBW at $V_S = 3\text{V}$ and $V_S = \pm 15\text{V}$ tests.

TYPICAL PERFORMANCE CHARACTERISTICS

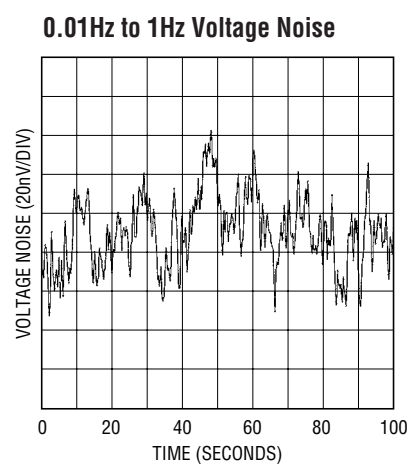
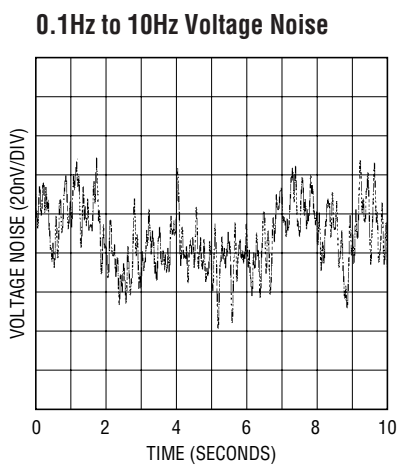
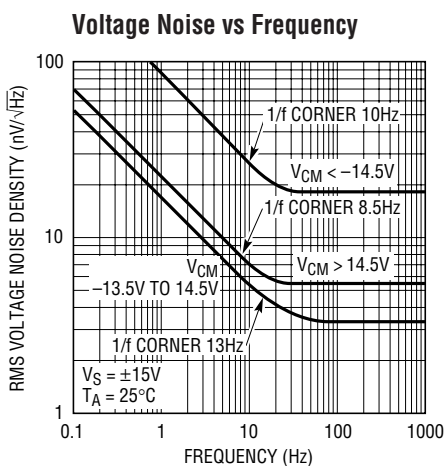

TYPICAL PERFORMANCE CHARACTERISTICS

Voltage Noise vs Temperature

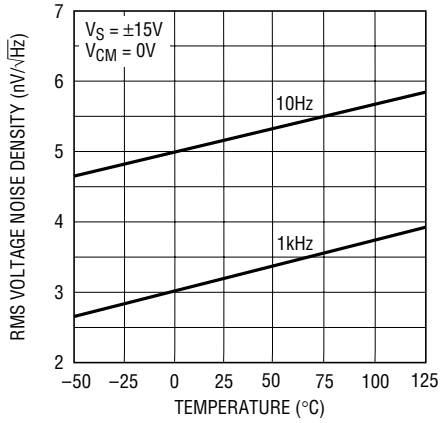

Current Noise vs Frequency

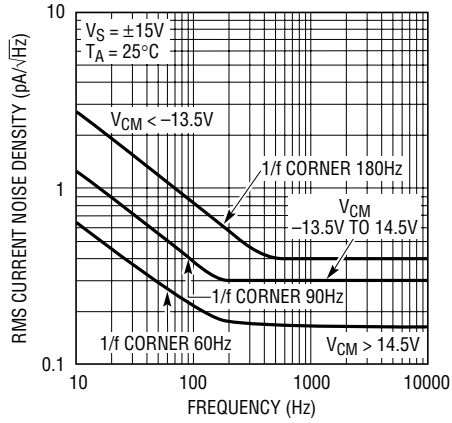

Input Bias Current vs Temperature

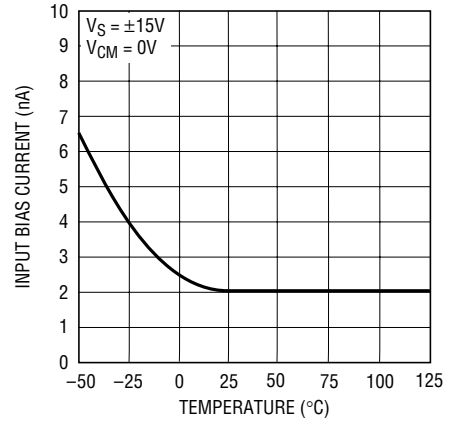

Input Bias Current vs Temperature

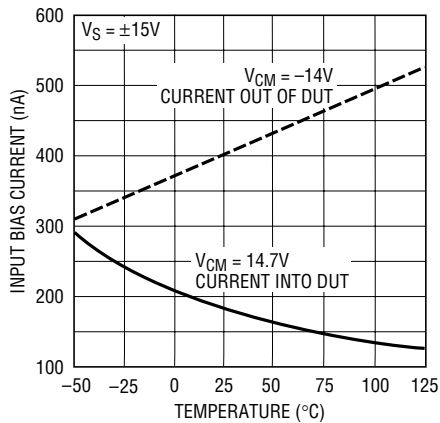

Input Bias Current Over the Common Mode Range

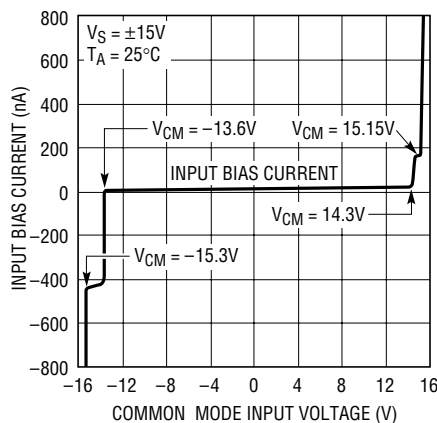

Offset Voltage Shift vs Common Mode

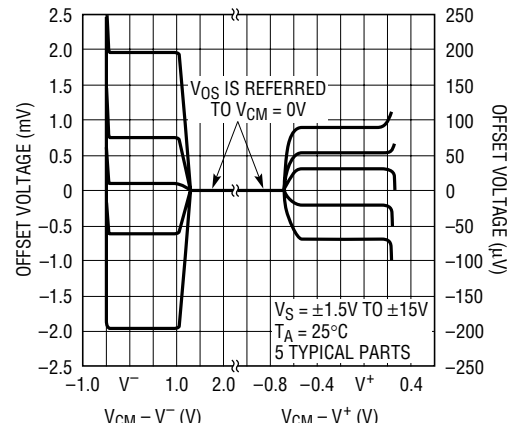

Warm-Up Drift

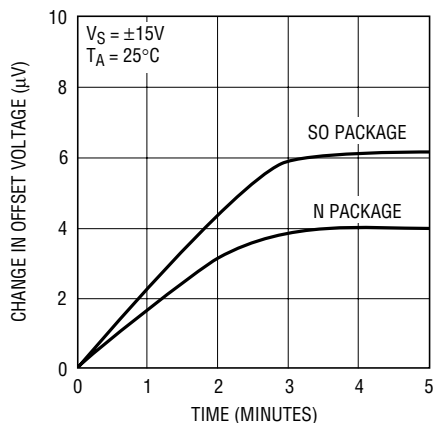

Distribution of Input Offset Voltage Drift (N8)

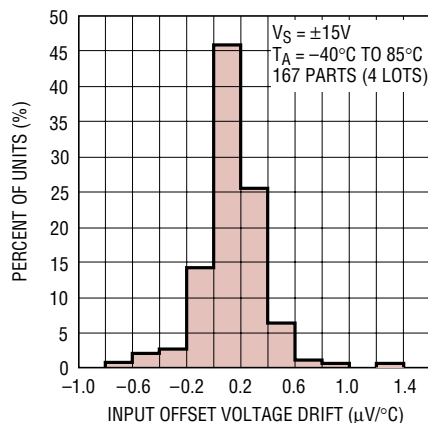

Distribution of Input Offset Voltage Drift (SO-8)

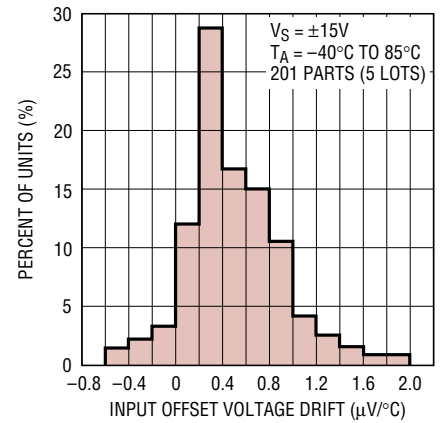

TYPICAL PERFORMANCE CHARACTERISTICS

V_{OS} vs Temperature of Representative Units

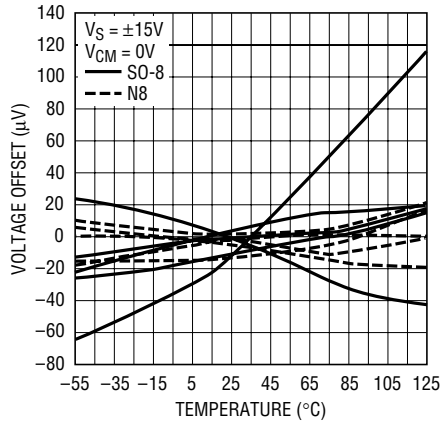

1677 G11

Common Mode Range vs Temperature

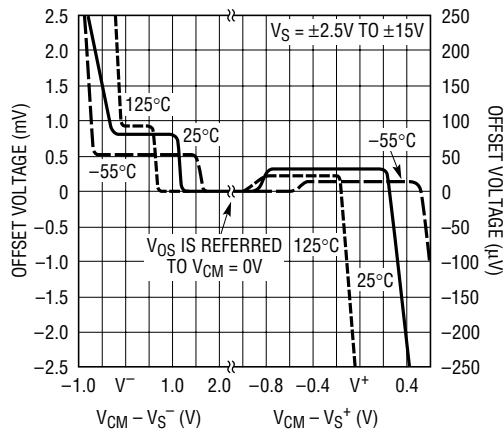

1677 G12

Long-Term Stability of Four Representative Units

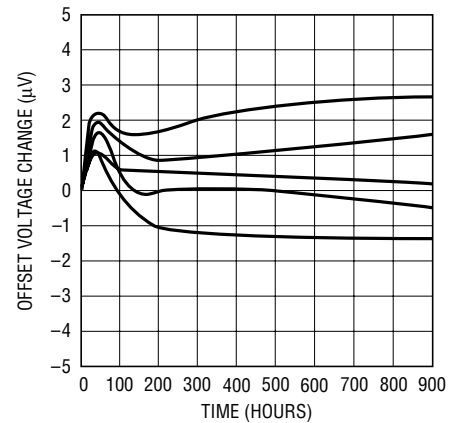

1677 G14

Supply Current vs Supply Voltage

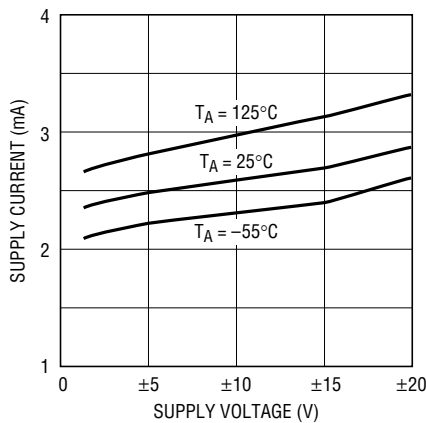

1677 G15

Common Mode Rejection Ratio vs Frequency

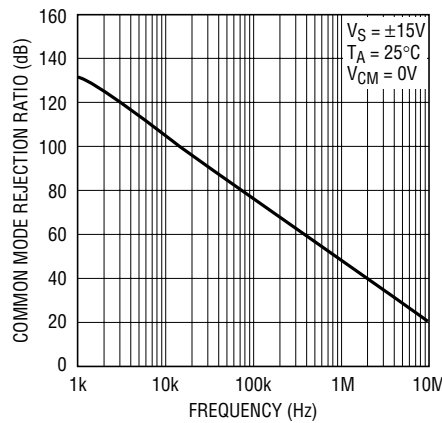

1677 G16

Power Supply Rejection Ratio vs Frequency

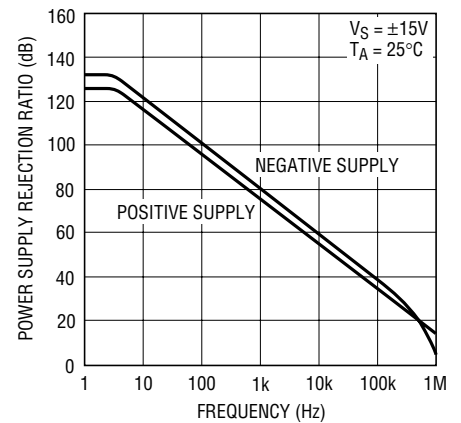

1677 G17

Voltage Gain vs Frequency

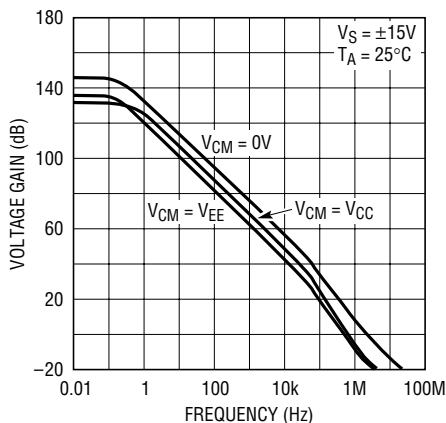

1677 G18

Voltage Gain vs Supply Voltage (Single Supply)

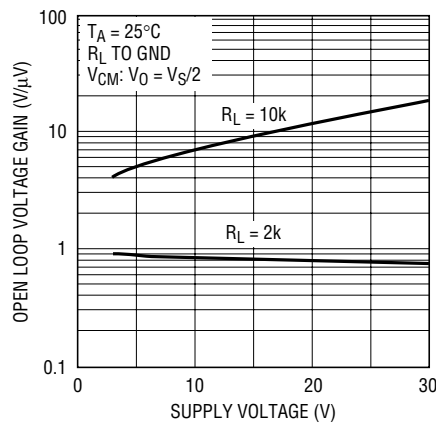

1677 G19

Overshoot vs Load Capacitance

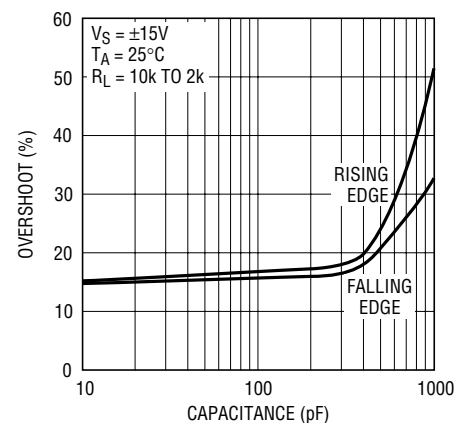

1677 G21

TYPICAL PERFORMANCE CHARACTERISTICS

PM, GBWP, SR vs Temperature

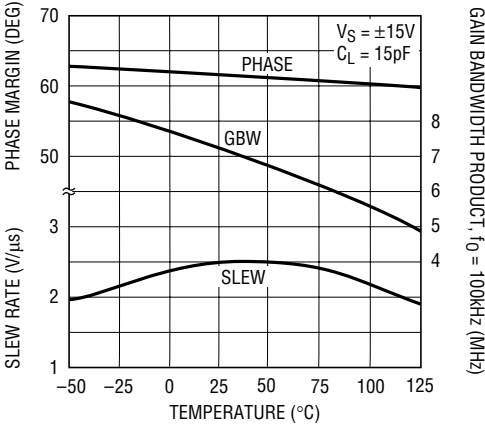

1677 G22

Large-Signal Transient Response

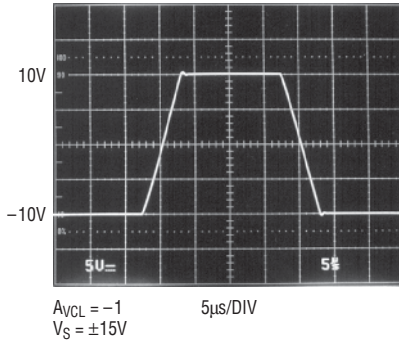

Small-Signal Transient Response

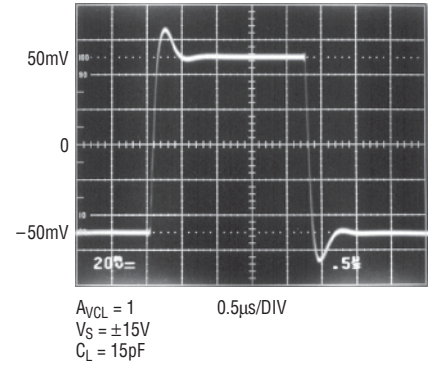

Settling Time vs Output Step (Inverting)

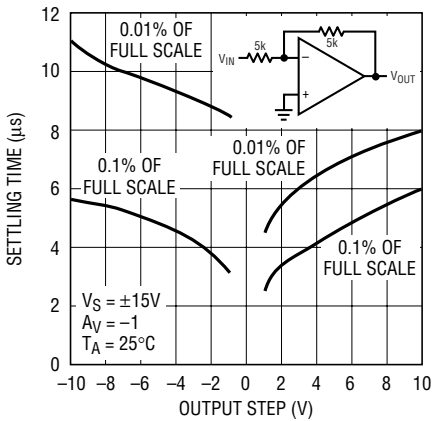

1677 G25

Settling Time vs Output Step (Noninverting)

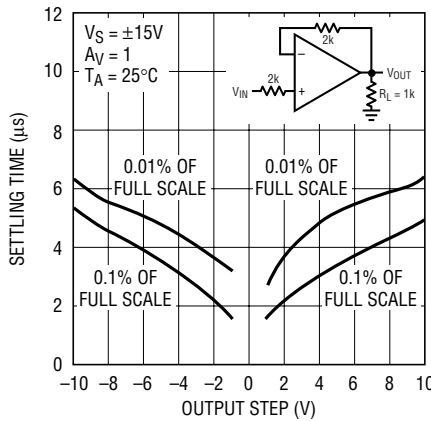

1677 G26

Gain, Phase Shift vs Frequency

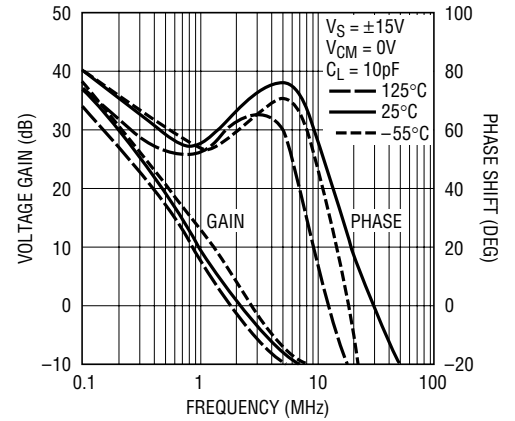

1677 G34

Gain, Phase Shift vs Frequency

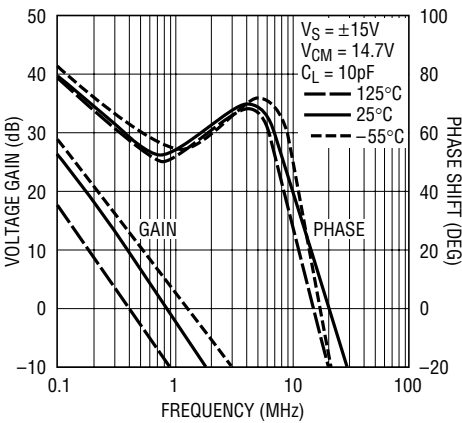

1677 G35

Gain, Phase Shift vs Frequency

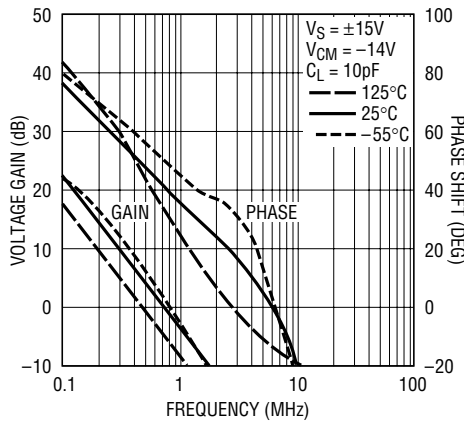

1677 G36

Output Voltage Swing vs Load Current

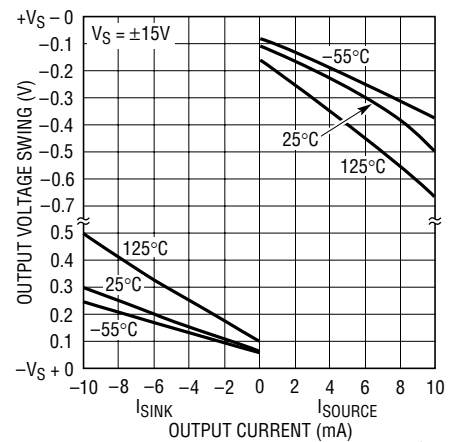

1677 G27

1677a

TYPICAL PERFORMANCE CHARACTERISTICS

Closed-Loop Output Impedance vs Frequency

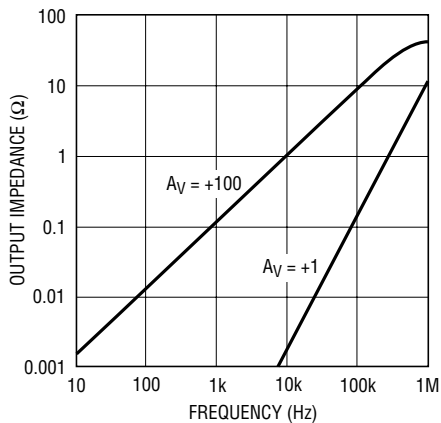

1677 G29

Output Short-Circuit Current vs Time

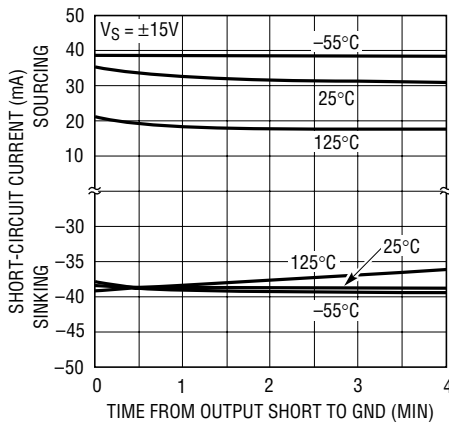

1677 G28

Total Harmonic Distortion and Noise vs Frequency for Noninverting Gain

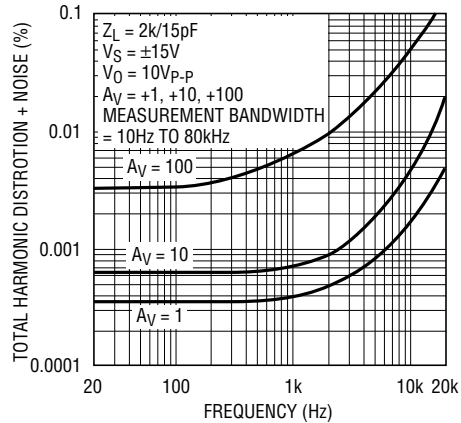

1677 G30

Total Harmonic Distortion and Noise vs Frequency for Inverting Gain

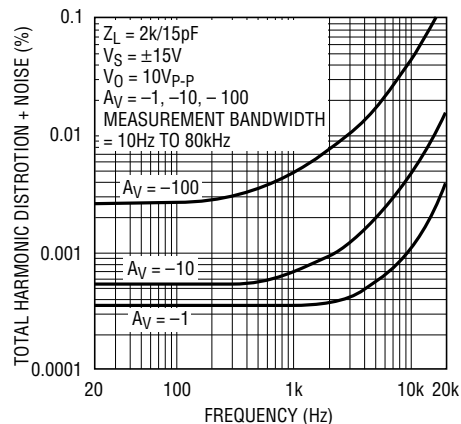

1677 G31

Total Harmonic Distortion and Noise vs Output Amplitude for Noninverting Gain

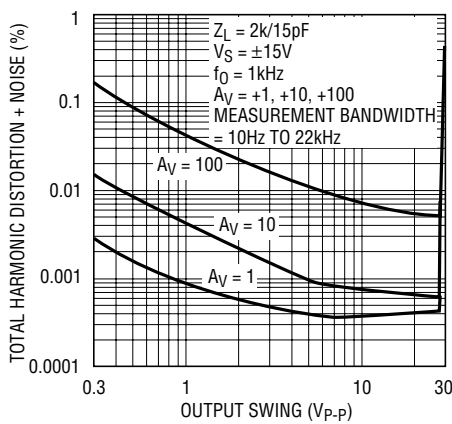

1677 G32

Total Harmonic Distortion and Noise vs Output Amplitude for Inverting Gain

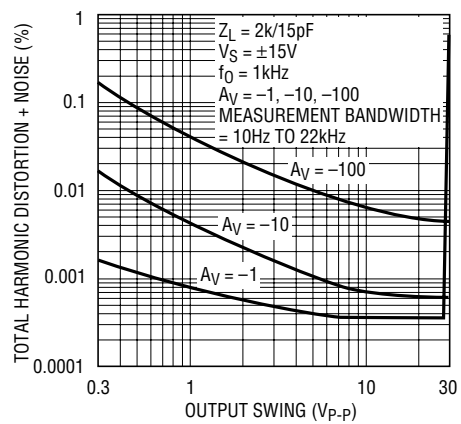

1677 G33

APPLICATIONS INFORMATION

General

The LT1677 series devices may be inserted directly into OP-07, OP-27, OP-37 and sockets with or without removal of external compensation or nulling components. In addition, the LT1677 may be fitted to 741 sockets with the removal or modification of external nulling components.

Rail-to-Rail Operation

To take full advantage of an input range that can exceed the supply, the LT1677 is designed to eliminate phase reversal. Referring to the photographs shown in Figure 1, the LT1677 is operating in the follower mode ($A_V = +1$) at a single 3V supply. The output of the LT1677 clips cleanly and recovers with no phase reversal. This has the benefit of preventing lock-up in servo systems and minimizing distortion components.

Offset Voltage Adjustment

The input offset voltage of the LT1677 and its drift with temperature are permanently trimmed at wafer testing to a low level. However, if further adjustment of V_{OS} is necessary, the use of a 10k Ω nulling potentiometer will not degrade drift with temperature. Trimming to a value other than zero creates a drift of $(V_{OS}/300)\mu V/^\circ C$, e.g., if V_{OS} is adjusted to 300 μV , the change in drift will be 1 $\mu V/^\circ C$ (Figure 2).

The adjustment range with a 10k Ω pot is approximately $\pm 2.5mV$. If less adjustment range is needed, the sensitivity and resolution of the nulling can be improved by using a smaller pot in conjunction with fixed resistors. The example has an approximate null range of $\pm 200\mu V$ (Figure 3).

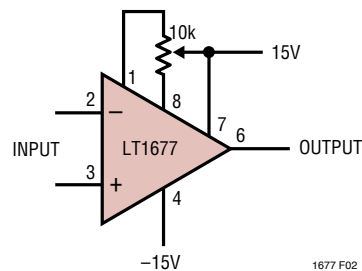

Figure 2. Standard Adjustment

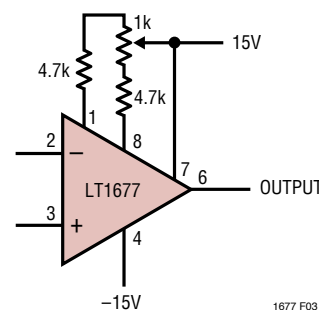

Figure 3. Improved Sensitivity Adjustment

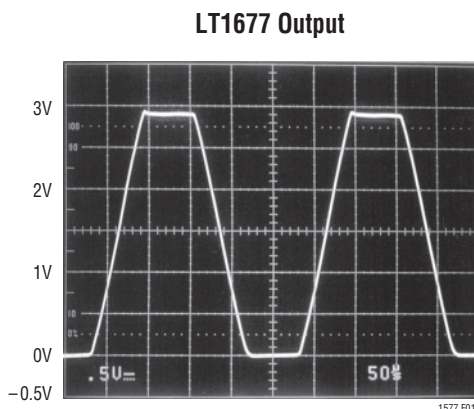
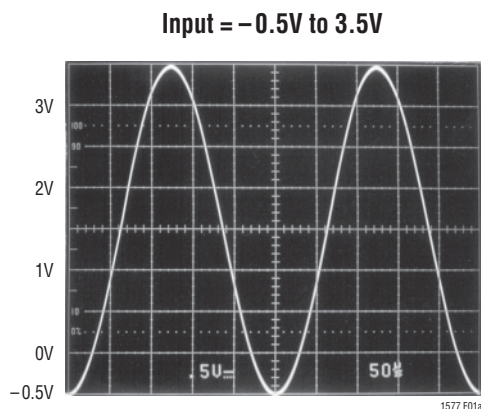

Figure 1. Voltage Follower with Input Exceeding the Supply Voltage ($V_S = 3V$)

APPLICATIONS INFORMATION

Offset Voltage and Drift

Thermocouple effects, caused by temperature gradients across dissimilar metals at the contacts to the input terminals, can exceed the inherent drift of the amplifier unless proper care is exercised. Air currents should be minimized, package leads should be short, the two input leads should be close together and maintained at the same temperature.

The circuit shown to measure offset voltage is also used as the burn-in configuration for the LT1677, with the supply voltages increased to $\pm 20\text{V}$ (Figure 4).

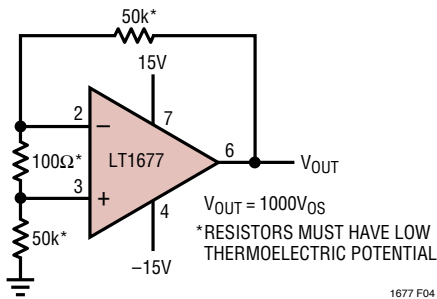

Figure 4. Test Circuit for Offset Voltage and Offset Voltage Drift with Temperature

Unity-Gain Buffer Application

When $R_F \leq 100\Omega$ and the input is driven with a fast, large-signal pulse ($>1\text{V}$), the output waveform will look as shown in the pulsed operation diagram (Figure 5).

During the fast feedthrough-like portion of the output, the input protection diodes effectively short the output to the input and a current, limited only by the output short-circuit protection, will be drawn by the signal generator. With $R_F \geq 500\Omega$, the output is capable of handling the current requirements ($I_L \leq 20\text{mA}$ at 10V) and the amplifier stays in its active mode and a smooth transition will occur.

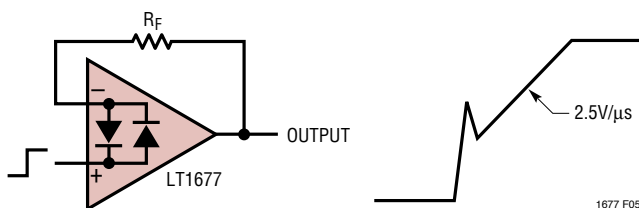

Figure 5. Pulsed Operation

As with all operational amplifiers when $R_F > 2\text{k}$, a pole will be created with R_F and the amplifier's input capacitance, creating additional phase shift and reducing the phase margin. A small capacitor (20pF to 50pF) in parallel with R_F will eliminate this problem.

Noise Testing

The 0.1Hz to 10Hz peak-to-peak noise of the LT1677 is measured in the test circuit shown (Figure 6a). The frequency response of this noise tester (Figure 6b) indicates that the 0.1Hz corner is defined by only one zero. The test time to measure 0.1Hz to 10Hz noise should not exceed ten seconds, as this time limit acts as an additional zero to eliminate noise contributions from the frequency band below 0.1Hz .

Measuring the typical 90nV peak-to-peak noise performance of the LT1677 requires special test precautions:

1. The device should be warmed up for at least five minutes. As the op amp warms up, its offset voltage changes typically $3\mu\text{V}$ due to its chip temperature increasing 10°C to 20°C from the moment the power supplies are turned on. In the ten-second measurement interval these temperature-induced effects can easily exceed tens of nanovolts.
2. For similar reasons, the device must be well shielded from air currents to eliminate the possibility of thermoelectric effects in excess of a few nanovolts, which would invalidate the measurements.
3. Sudden motion in the vicinity of the device can also "feedthrough" to increase the observed noise.

Current noise is measured in the circuit shown in Figure 7 and calculated by the following formula:

$$i_n = \frac{\left[(e_{no})^2 - (130\text{nV} \cdot 101)^2 \right]^{1/2}}{(1\text{M}\Omega)(101)}$$

The LT1677 achieves its low noise, in part, by operating the input stage at $100\mu\text{A}$ versus the typical $10\mu\text{A}$ of most other op amps. Voltage noise is inversely proportional while current noise is directly proportional to the square

APPLICATIONS INFORMATION

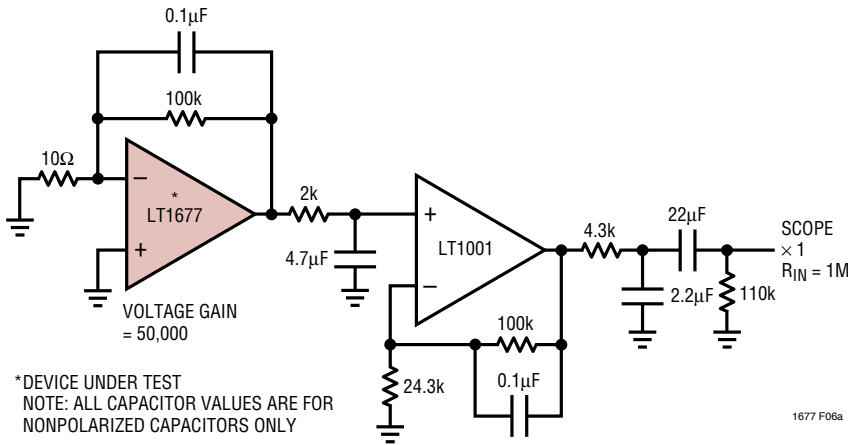

Figure 6a. 0.1Hz to 10Hz Noise Test Circuit

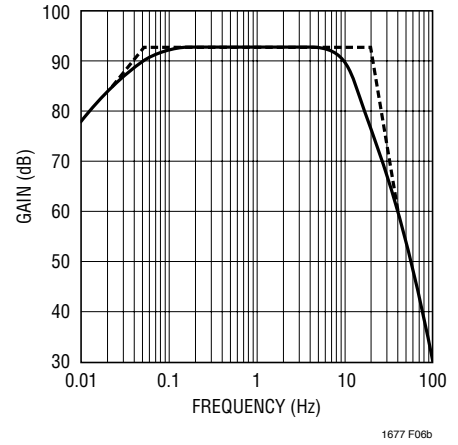

Figure 6b. 0.1Hz to 10Hz Peak-to-Peak Noise Tester Frequency Response

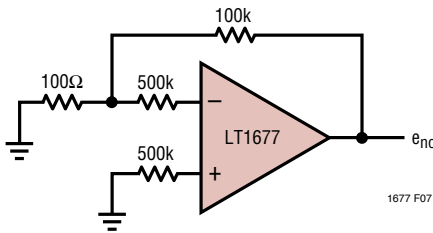

Figure 7

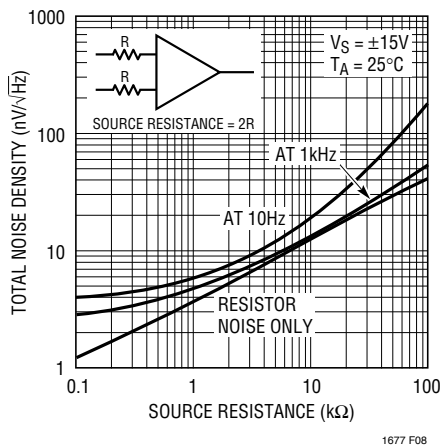

Figure 8. Total Noise vs Source Resistance

root of the input stage current. Therefore, the LT1677's current noise will be relatively high. At low frequencies, the low $1/f$ current noise corner frequency ($\approx 90\text{Hz}$) minimizes current noise to some extent.

In most practical applications, however, current noise will not limit system performance. This is illustrated in the Total Noise vs Source Resistance plot (Figure 8) where:

$$\text{Total Noise} = [(\text{op amp voltage noise})^2 + (\text{resistor noise})^2 + (\text{current noise } R_S)^2]^{1/2}$$

Three regions can be identified as a function of source resistance:

- (i) $R_S \leq 400\Omega$. Voltage noise dominates
- (ii) $400\Omega \leq R_S \leq 50\text{k}$ at 1kHz } Resistor noise dominates
- $400\Omega \leq R_S \leq 8\text{k}$ at 10Hz }
- (iii) $R_S > 50\text{k}$ at 1kHz } Current noise dominates
- $R_S > 8\text{k}$ at 10Hz }

Clearly the LT1677 should not be used in region (iii), where total system noise is at least six times higher than the voltage noise of the op amp, i.e., the low voltage noise specification is completely wasted. In this region the LT1792 or LT1793 is the best choice.

APPLICATIONS INFORMATION

Rail-to-Rail Input

The LT1677 has the lowest voltage noise, offset voltage and highest gain when compared to any rail-to-rail op amp. The input common mode range for the LT1677 can exceed the supplies by at least 100mV. As the common mode voltage approaches the positive rail ($+V_S - 0.7V$), the tail current for the input pair (Q1, Q2) is reduced, which prevents the input pair from saturating (refer to the Simplified Schematic). The voltage drop across the load resistors R_{C1} , R_{C2} is reduced to less than 200mV, degrading the slew rate, bandwidth, voltage noise, offset voltage and input bias current (the cancellation is shut off).

When the input common mode range goes below 1.5V above the negative rail, the NPN input pair (Q1, Q2) shuts off and the PNP input pair (Q8, Q9) turns on. The offset voltage, input bias current, voltage noise and bandwidth are also degraded. The graph of Offset Voltage Shift vs Common Mode shows where the knees occur by displaying the change in offset voltage. The change-over points are temperature dependent, see the graph Common Mode Range vs Temperature.

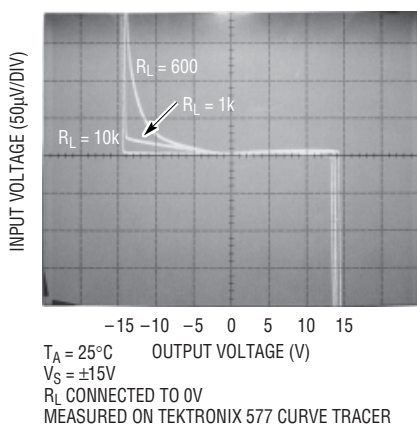

Figure 9. Voltage Gain Split Supply

Rail-to-Rail Output

The rail-to-rail output swing is achieved by using transistor collectors (Q28, Q29) instead of customary class A-B emitter followers for the output stage. Referring to the Simplified Schematic, the output NPN transistor (Q29) sinks the current necessary to move the output in the negative direction. The change in Q29's base emitter voltage is reflected directly to the gain node (collectors of Q20 and Q16). For large sinking currents, the delta V_{BE} of Q29 can dominate the gain. Figure 9 shows the change in input voltage for a change in output voltage for different load resistors connected between the supplies. The gain is much higher for output voltages above ground (Q28 sources current) since the change in base emitter voltage of Q28 is attenuated by the gain in the PNP portion of the output stage. Therefore, for positive output swings (output sourcing current) there is hardly any change in input voltage for any load resistance. Highest gain and best linearity is achieved when the output is sourcing current, which is the case in single supply operation when the load is ground referenced. Figure 10 shows gains for both sinking and sourcing load currents for a worst-case load of 600Ω.

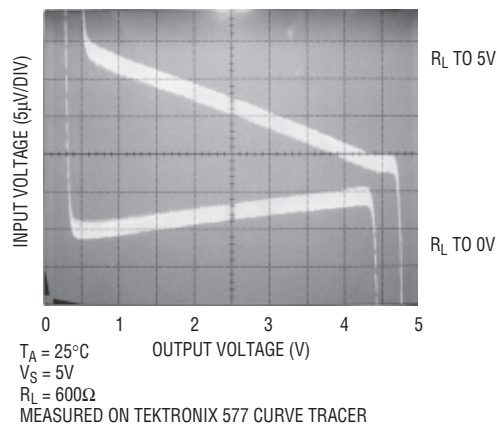
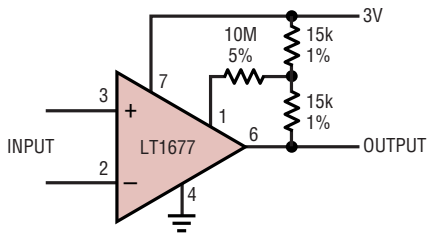

Figure 10. Voltage Gain Single Supply

TYPICAL APPLICATIONS

Microvolt Comparator with Hysteresis



1677 TA03

POSITIVE FEEDBACK TO ONE OF THE NULLING TERMINALS CREATES APPROXIMATELY 5μV OF HYSTERESIS. OUTPUT CAN SINK 16mA
 INPUT OFFSET VOLTAGE IS TYPICALLY CHANGED LESS THAN 5μV DUE TO THE FEEDBACK

3V Strain Gauge Amplifier

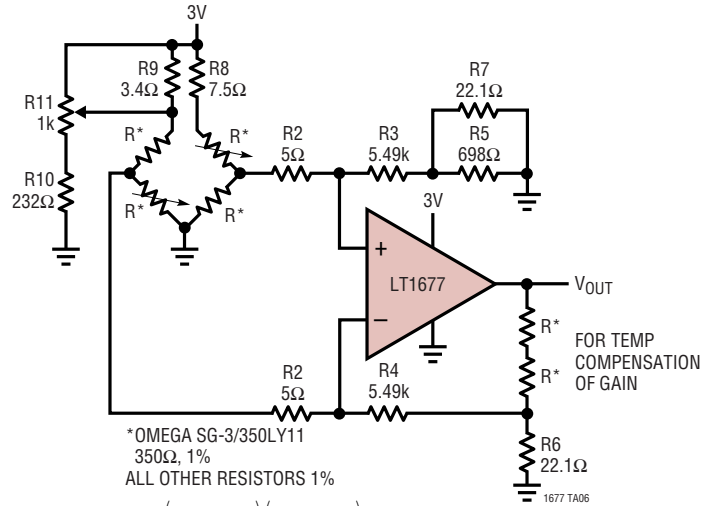

*OMEGA SG-3/350LY11
 350Ω, 1%
 ALL OTHER RESISTORS 1%

$$A_V = \left(\frac{2 \cdot R^* + R_6}{R_6} \right) \left(\frac{R_4}{R_2 + (R^*/2)} \right) \cong 1000$$

 TRIM R11 FOR BRIDGE BALANCE

Precision High Side Current Sense

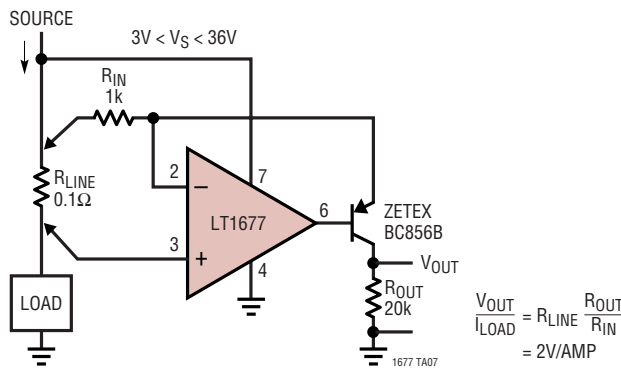

$$\frac{V_{OUT}}{I_{LOAD}} = R_{LINE} \frac{R_{OUT}}{R_{IN}} = 2V/AMP$$

1677 TA07

TYPICAL APPLICATIONS

3V Super Electret Microphone Amplifier with DC Servo

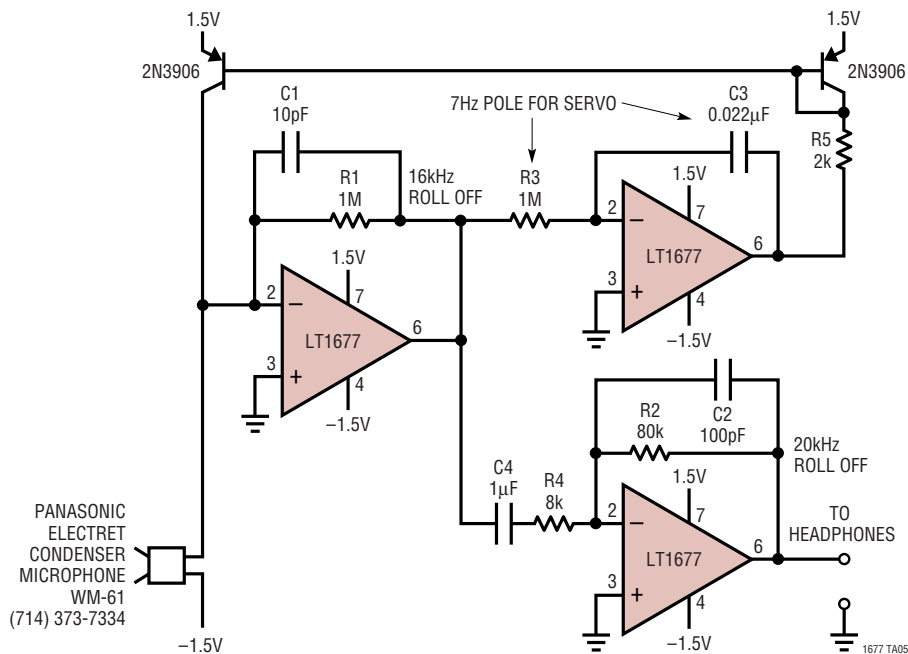

SIMPLIFIED SCHEMATIC

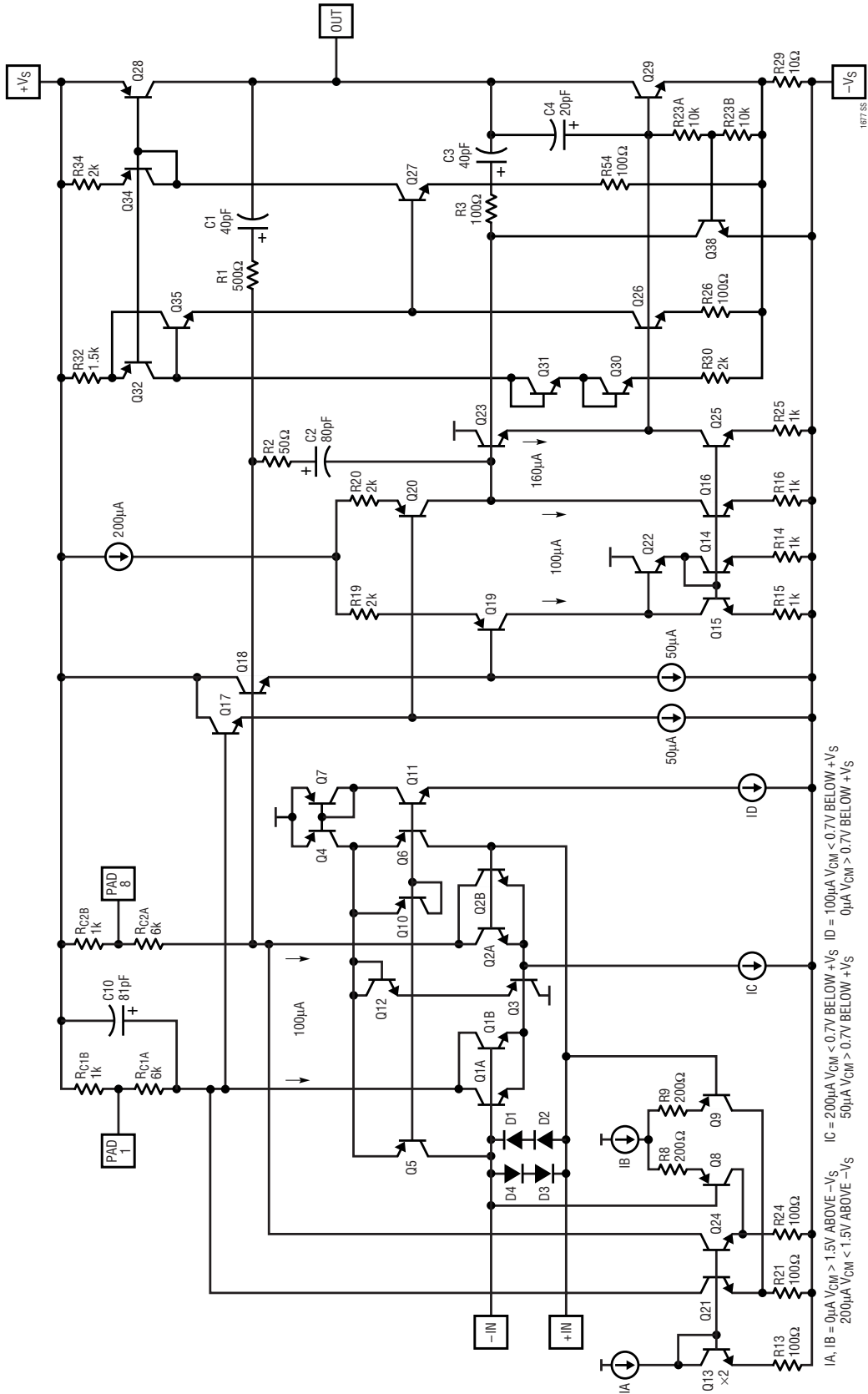

PACKAGE DESCRIPTION

Dimensions in inches (millimeters) unless otherwise noted.

N8 Package 8-Lead PDIP (Narrow 0.300) (LTC DWG # 05-08-1510)

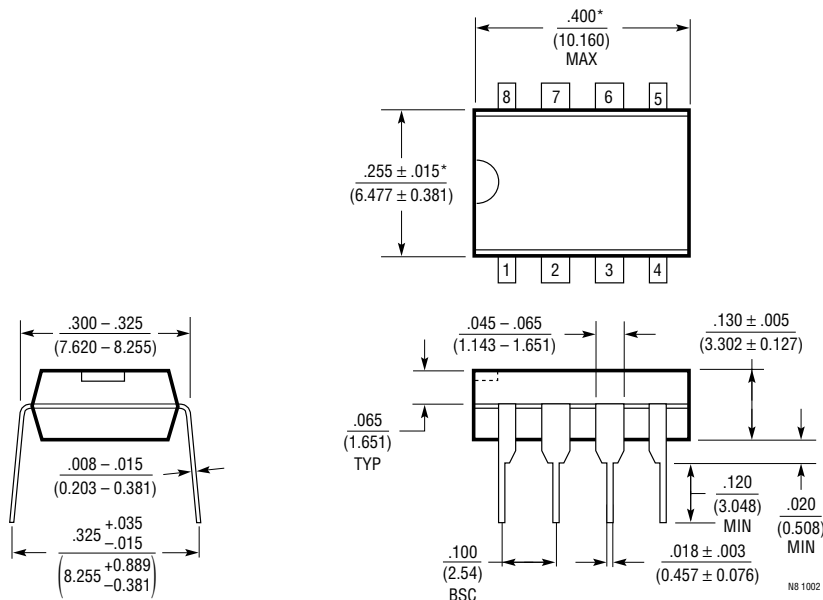

NOTE:
1. DIMENSIONS ARE $\frac{\text{INCHES}}{\text{MILLIMETERS}}$
*THESE DIMENSIONS DO NOT INCLUDE MOLD FLASH OR PROTRUSIONS.
MOLD FLASH OR PROTRUSIONS SHALL NOT EXCEED .010 INCH (0.254mm)

S8 Package 8-Lead Plastic Small Outline (Narrow 0.150) (LTC DWG # 05-08-1610)

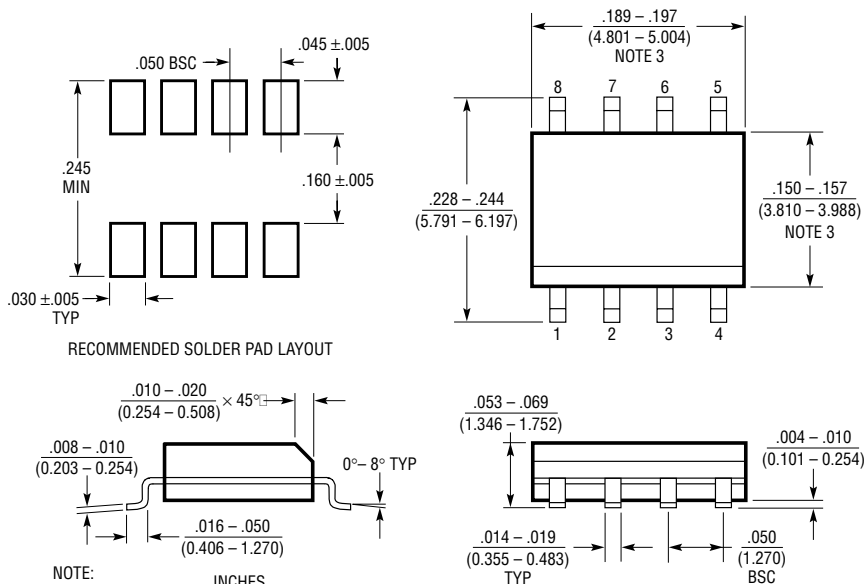

RECOMMENDED SOLDER PAD LAYOUT

NOTE:
1. DIMENSIONS IN $\frac{\text{INCHES}}{\text{MILLIMETERS}}$
2. DRAWING NOT TO SCALE
3. THESE DIMENSIONS DO NOT INCLUDE MOLD FLASH OR PROTRUSIONS.
MOLD FLASH OR PROTRUSIONS SHALL NOT EXCEED .006* (0.15mm)

S08 0303

TYPICAL APPLICATION

This 2-wire remote Geophone preamp operates on a current-loop principle and so has good noise immunity. Quiescent current is $\approx 10\text{mA}$ for a V_{OUT} of 2.5V . Excitation will cause AC currents about this point of $\approx \pm 4\text{mA}$ for a V_{OUT} of $\approx \pm 1\text{V}$ max. The op amp is configured for a voltage

gain of ~ 107 . Components R5 and Q1 convert the voltage into a current for transmission back to R10, which converts it into a voltage again. The LM334 and 2N3904 are not temperature compensated so the DC output contains temperature information.

2-Wire Remote Geophone Preamp

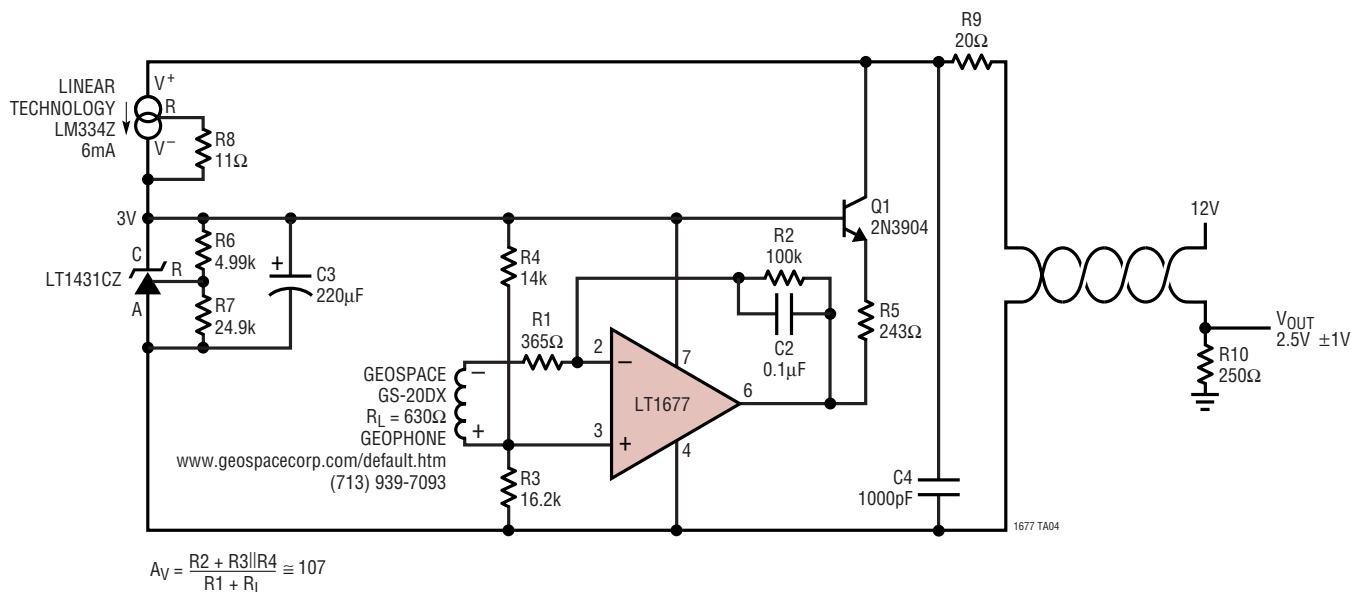

RELATED PARTS

PART NUMBER	DESCRIPTION	COMMENTS
LT1028/LT1128	Ultralow Noise Precision Op Amps	Lowest Noise $0.85\text{nV}/\sqrt{\text{Hz}}$
LT1115	Ultralow Noise, Low distortion Audio Op Amp	0.002% THD, Max Noise $1.2\text{nV}/\sqrt{\text{Hz}}$
LT1124/LT1125	Dual/Quad Low Noise, High Speed Precision Op Amps	Similar to LT1007
LT1126/LT1127	Dual/Quad Decompensated Low Noise, High Speed Precision Op Amps	Similar to LT1037
LT1226	Low Noise, Very High Speed Op Amp	1GHz , $2.6\text{nV}/\sqrt{\text{Hz}}$, Gain of 25 Stable
LT1498/LT1499	10MHz , $5\text{V}/\mu\text{s}$, Dual/Quad Rail-to-Rail Input and Output Op Amps	Precision C-Load™ Stable
LT1792	Low Noise, Precision JFET Input Op Amp	$4.2\text{nV}/\sqrt{\text{Hz}}$, $10\text{fA}/\sqrt{\text{Hz}}$
LT1793	Low Noise, Picoampere Bias Current Op Amp	$6\text{nV}/\sqrt{\text{Hz}}$, $1\text{fA}/\sqrt{\text{Hz}}$, $I_B = 10\text{pA}$ Max
LT1806	Low Noise, 325MHz Rail-to-Rail Input and Output Op Amp	$3.5\text{nV}/\sqrt{\text{Hz}}$
LT1881/LT1882	Dual/Quad Rail-to-Rail Output Picoamp Input Precision Op Amps	C_{LOAD} to 1000pF , $I_B = 200\text{pA}$ Max
LT1884/LT1885	Dual/Quad Rail-to-Rail Output Picoamp Input Precision Op Amps	2.2MHz Bandwidth, $1.2\text{V}/\mu\text{s}$ SR

C-Load is a trademark of Linear Technology Corporation.