

## FEATURES

- **High Voltage: Operation Up to 60V Max**
- **High Current: N-Channel Drive Handles Up to 10,000pF Gate Capacitance**
- Programmable Average Current Limiting
- 5V Reference Output with 10mA External Loading Capability
- Fixed Frequency Current Mode Operation
- Oscillator Synchronizable Up to 200kHz
- Undervoltage Lockout with Hysteresis
- Programmable Start Inhibit for Power Supply Sequencing and Protection
- User Adjustable Slope Compensation

## APPLICATIONS

- High Power Single Board Systems
- Distributed Power Converters
- Industrial Control Systems
- Lead-Acid Battery Back-Up Systems
- Automotive and Heavy Equipment

## DESCRIPTION

The LT<sup>®</sup>1680 is a high power, current mode switching power supply controller optimized for boost topologies. The IC drives N-channel MOSFET switches for DC/DC converters in applications up to 60V input. A high current gate drive output handles up to 10,000pF gate capacitance, enabling the construction of high power DC/DC converters. Current sense common mode range up to 60V allows current sensing to be referenced to the input supply, eliminating the need for sense blanking circuits.

The LT1680 incorporates programmable average current limiting allowing accurate limiting of DC current in the magnetics, independent of ripple current. User adjustable slope compensation provides stable operation at duty cycles up to 90%.

The LT1680 operating frequency is programmable and can be synchronized up to 200kHz. Minimum off-time operation provides switch protection. The IC also incorporates a soft start feature that is gated by both shutdown and undervoltage lockout conditions.

LT, LTC and LT are registered trademarks of Linear Technology Corporation.

## TYPICAL APPLICATION

12V to 48V, 250W Boost

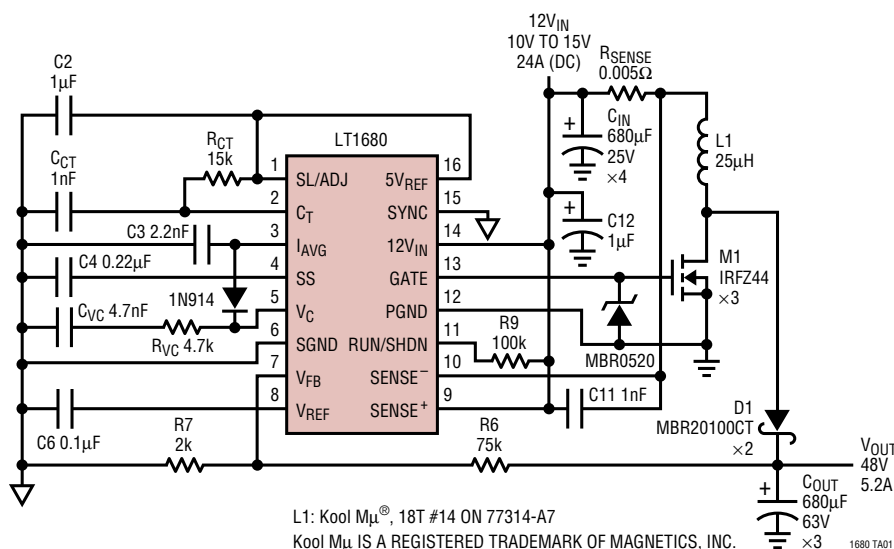

Efficiency vs Output Power

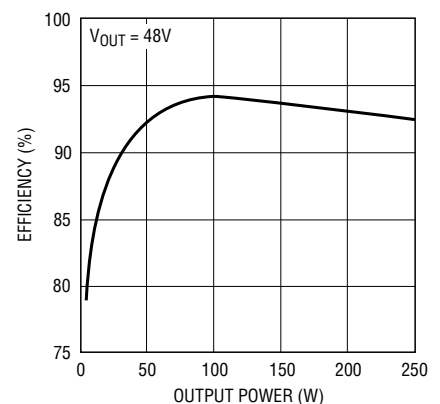

## ABSOLUTE MAXIMUM RATINGS

(Note 1)

Power Supply Voltage ( $12V_{IN}$ ) .....	-0.3V to 20V
Sense Amplifier Input Common Mode .....	-0.3V to 60V
GATE Pin Voltage .....	-0.3V to $12V_{IN} + 0.3V$
RUN/SHDN Pin Voltage .....	-0.3V to $12V_{IN}$
All Other Pin Voltages .....	-0.3V to 7V
5V Reference Output Current .....	65mA
Operating Ambient Temperature Range	
LT1680C .....	0°C to 70°C
LT1680I .....	-40°C to 85°C
Storage Temperature Range .....	-65°C to 150°C
Lead Temperature (Soldering, 10 sec).....	300°C

## PACKAGE/ORDER INFORMATION

TOP VIEW		ORDER PART NUMBER
SL/ADJ 1	16 5V <sub>REF</sub>	
C <sub>T</sub> 2	15 SYNC	LT1680CN LT1680CSW LT1680IN LT1680ISW
I <sub>AVG</sub> 3	14 12V <sub>IN</sub>	
SS 4	13 GATE	
V <sub>C</sub> 5	12 PGND	
SGND 6	11 RUN/SHDN	
V <sub>FB</sub> 7	10 SENSE <sup>-</sup>	
V <sub>REF</sub> 8	9 SENSE <sup>+</sup>	
N PACKAGE      SW PACKAGE		
16-LEAD PDIP      16-LEAD PLASTIC SO WIDE		
T <sub>JMAX</sub> = 125°C, θ <sub>JA</sub> = 75°C/W (N)		
T <sub>JMAX</sub> = 125°C, θ <sub>JA</sub> = 90°C/W (SW)		

Consult factory for Military grade parts.

## ELECTRICAL CHARACTERISTICS

12V<sub>IN</sub> = 12V, V<sub>VC</sub> = 2V, V<sub>FB</sub> = V<sub>REF</sub> = 1.25V, C<sub>GATE</sub> = 3000pF, T<sub>A</sub> = 25°C unless otherwise noted.

SYMBOL	PARAMETER	CONDITIONS	MIN	TYP	MAX	UNITS	
<b>Supply and Protection</b>							
I <sub>12VIN</sub>	DC Active Supply Current (Note 2)	Gate Output On Gate Output Off	●	15 12	22	mA mA	
	DC Standby Supply Current	V <sub>RUN</sub> < 0.5V	●	65	110	μA	
V <sub>RUN/SHDN</sub>	Shutdown Rising Threshold		●	1.15	1.25	1.35	V
V <sub>SSHYST</sub>	Shutdown Threshold Hysteresis			15		mV	
I <sub>SS</sub>	Soft Start Charge Current		●	5	8	14	μA
V <sub>UVLO</sub>	Undervoltage Lockout Threshold - Falling		●	8.20	9.00	9.75	V
	Undervoltage Lockout Threshold - Rising		●		9.35	9.95	V
	Undervoltage Lockout Hysteresis		●	200	350		mV
<b>5V Reference</b>							
V <sub>REF5</sub>	5V Reference Voltage	Line, Load and Temperature	●	4.75	5	5.25	V
	5V Reference Line Regulation	10V ≤ 12V <sub>IN</sub> ≤ 15V	●		3	5	mV/V
I <sub>REF5</sub>	5V Reference Load Range - DC Pulse		●		10		mA
			●		20		mA
	5V Reference Load Regulation	0 ≤ I <sub>REF5</sub> ≤ 20mA	●		-1.25	-2	V/A
I <sub>SC</sub>	5V Reference Short-Circuit Current				45		mA
<b>Error Amplifier</b>							
V <sub>FB</sub>	Error Amplifier Reference Voltage	Measured at Feedback Pin	●	1.242	1.250	1.258	V
			●	1.235		1.265	V
I <sub>FB</sub>	Feedback Input Current	V <sub>FB</sub> = V <sub>REF</sub>	●	0.1	0.5	1.0	μA
g <sub>m</sub>	Error Amplifier Transconductance		●	1200	2000	3200	μmho
A <sub>V</sub>	Error Amplifier Voltage Gain		●	1500	3000		V/V
I <sub>VC</sub>	Error Amplifier Source Current Error Amplifier Sink Current	V <sub>FB</sub> - V <sub>REF</sub> = 500mV	●	200	275		μA
			●	280	400		μA
V <sub>VC</sub>	Absolute V <sub>C</sub> Clamp Voltage	Measured at V <sub>C</sub> Pin			3.5		V

## ELECTRICAL CHARACTERISTICS

12V<sub>IN</sub> = 12V, V<sub>VC</sub> = 2V, V<sub>FB</sub> = V<sub>REF</sub> = 1.25V, C<sub>GATE</sub> = 3000pF, T<sub>A</sub> = 25°C unless otherwise noted.

SYMBOL	PARAMETER	CONDITIONS		MIN	TYP	MAX	UNITS
<b>Error Amplifier</b>							
V <sub>SENSE</sub>	Peak Current Limit Threshold	Measured at Sense Inputs	●	170	190		mV
	Average Current Limit Threshold	Measured at Sense Inputs, V <sub>CMSENSE</sub> = 10V	●	110	120	130	mV
V <sub>IAVG</sub>	Average Current Limit Threshold	Measured at I <sub>AVG</sub> Pin			2.5		V
<b>Current Sense Amplifier</b>							
A <sub>V</sub>	Amplifier DC Gain	Measured at I <sub>AVG</sub> Pin			15		V/V
V <sub>OS</sub>	Amplifier Input Offset Voltage	2V < V <sub>CMSENSE</sub> < 60V, SENSE <sup>+</sup> – SENSE <sup>-</sup> = 5mV	●	0.1			mV
I <sub>BIAS</sub>	Input Bias Current	Sink (V <sub>CMSENSE</sub> > 5V)	●		45	75	μA
		Source (V <sub>CMSENSE</sub> = 0V)	●		700	1200	μA
<b>Oscillator</b>							
f <sub>0</sub>	Operating Frequency, Free Run Frequency Programming Error	f <sub>0</sub> ≤ 200kHz, R <sub>CT</sub> = 16.9k, C <sub>CT</sub> = 1000pF	●			200	kHz
			●	-5		5	%
I <sub>CT</sub>	Timing Capacitor Discharge Current	LT1680C	●	2.20	2.5	2.75	mA
		LT1680I	●	2.10	2.5	2.75	mA
V <sub>SYNC</sub>	SYNC Input Threshold	Rising Edge	●	0.8		2.0	V
f <sub>SYNC</sub>	SYNC Frequency Range	f <sub>SYNC</sub> ≤ 200kHz	●	f <sub>0</sub>		1.4f <sub>0</sub>	
<b>Output Drivers</b>							
V <sub>GATE</sub>	Undervoltage Output Clamp	12V <sub>IN</sub> ≤ 8.2V	●		0.4	0.7	V
	Standby Mode Output Clamp	V <sub>RUN</sub> < 0.5V	●			0.1	V
	Gate Output On Voltage		●	11	11.9	12	V
	Gate Output Off Voltage		●		0.4	0.7	V
t <sub>GATER</sub>	Gate Output Rise Time		●		60	200	ns
t <sub>GATEF</sub>	Gate Output Fall Time		●		60	140	ns

The ● denotes specifications which apply over the full operating temperature range.

**Note 1:** Absolute Maximum Ratings are those values beyond which the life of a device may be impaired.

**Note 2:** Supply current specification does not include external FET gate charge currents. Actual supply currents will be higher and vary with operating frequency, operating voltages and the type of external FETs used. See Applications Information.

TYPICAL PERFORMANCE CHARACTERISTICS

**I<sub>12VIN</sub> Supply Current vs Temperature**

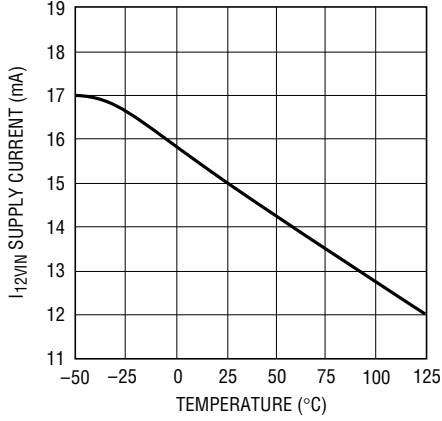

1680 G01

**I<sub>12VIN</sub> Supply Current vs 12V<sub>IN</sub> Supply Voltage**

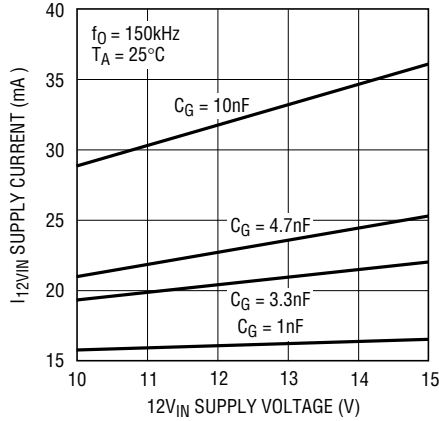

1680 G02

**Gate Transition Time vs CGATE**

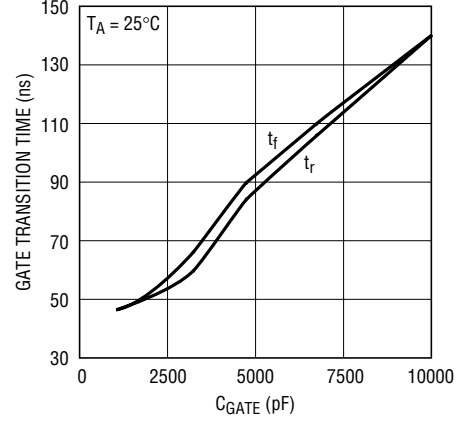

1680 G03

**5V<sub>REF</sub> Short-Circuit Current vs Temperature**

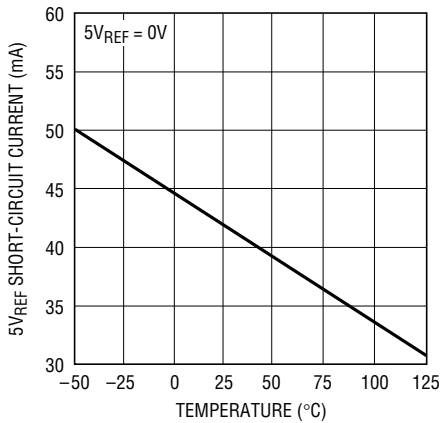

1680 G04

**I<sub>12VIN</sub> Shutdown Current vs Temperature**

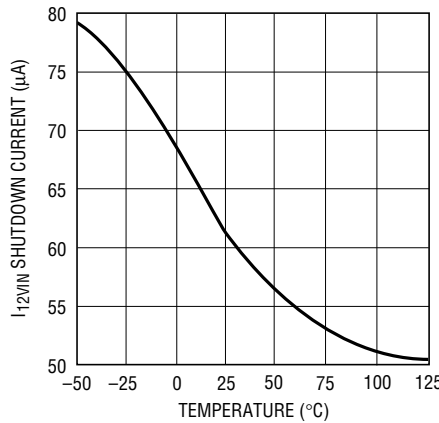

1680 G05

**V<sub>REF</sub> Voltage vs Temperature**

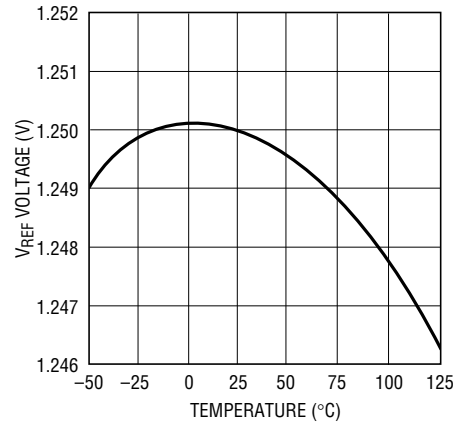

1680 G06

**5V<sub>REF</sub> Voltage vs Temperature**

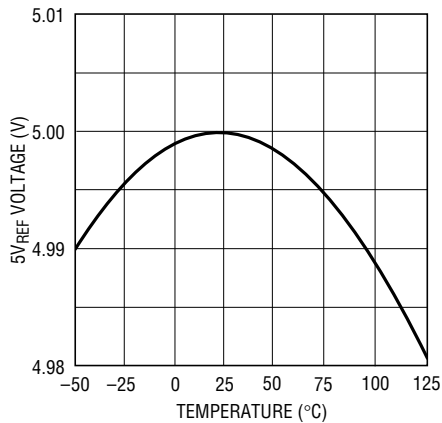

1680 G07

**Error Amplifier Voltage Gain vs Temperature**

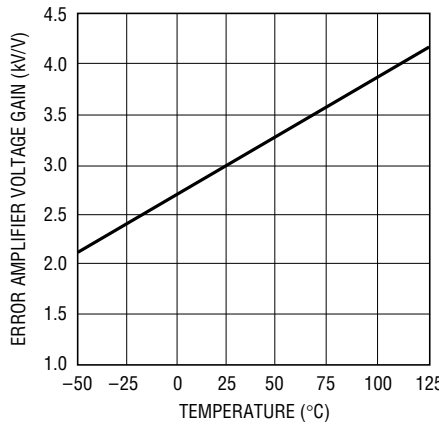

1680 G08

**Error Amplifier Transconductance vs Temperature**

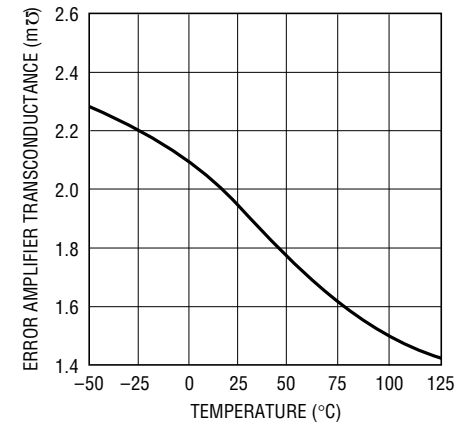

1680 G09

# TYPICAL PERFORMANCE CHARACTERISTICS

**Error Amplifier Source Current vs Temperature**

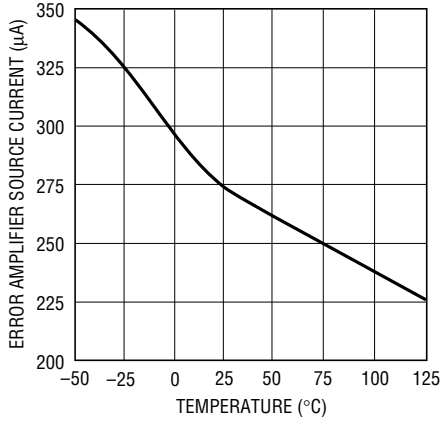

1680 G10

**SS Output Current vs Temperature**

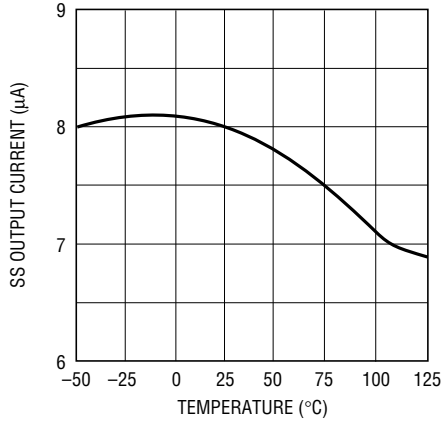

1680 G11

**RUN/SHDN Rising Threshold vs Temperature**

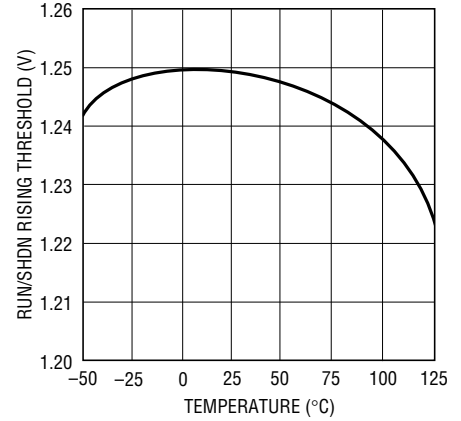

1680 G12

**RUN/SHDN Threshold Hysteresis vs Temperature**

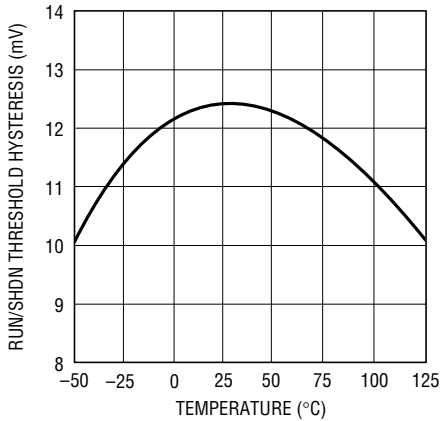

1680 G13

**Average Current Limit Threshold Sense Voltage vs Common Mode Voltage**

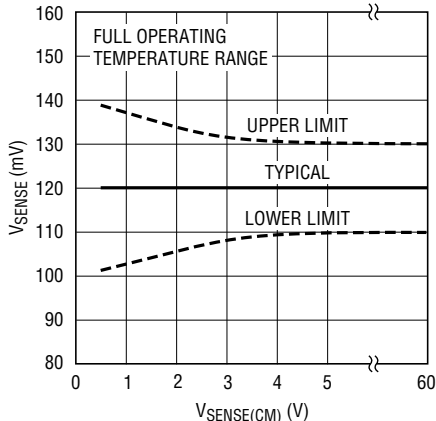

1680 G14

**UVLO Thresholds vs Temperature**

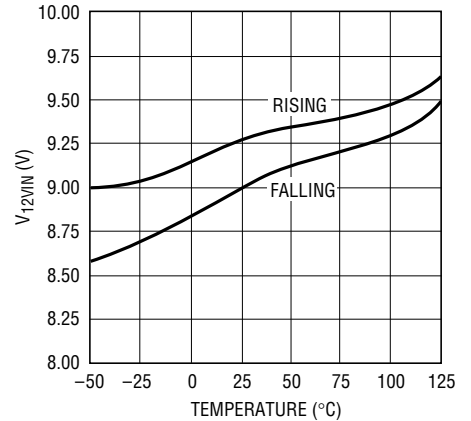

1680 G15

**Sense Amplifier Input Bias Current (Source) vs Temperature**

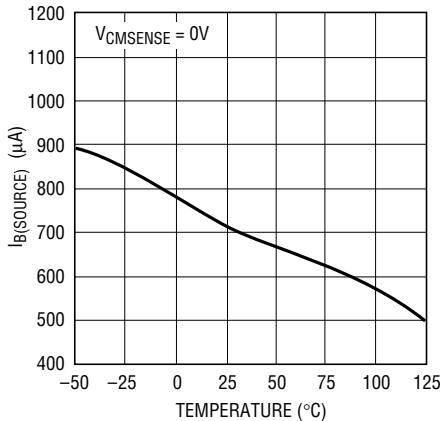

1680 G16

**Sense Amplifier Input Bias Current (Sink) vs Temperature**

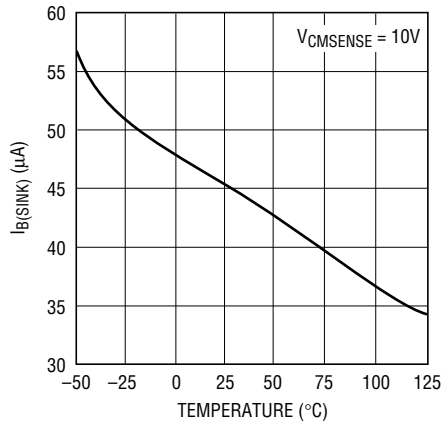

1680 G17

**RUN/SHDN Input Current vs Pin Voltage**

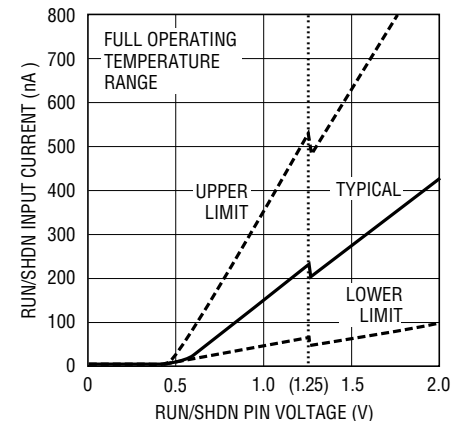

1680 G18

## TYPICAL PERFORMANCE CHARACTERISTICS

**RUN/SHDN Input Current vs Pin Voltage**

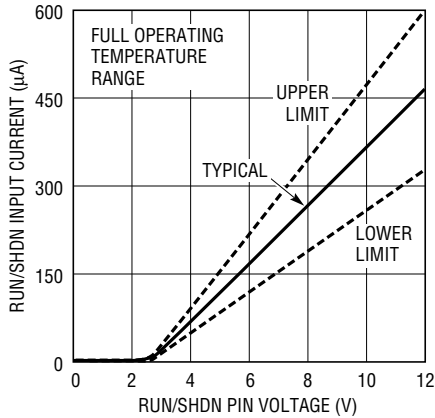

1680 G19

**Maximum Duty Cycle vs  $R_{CT}$**

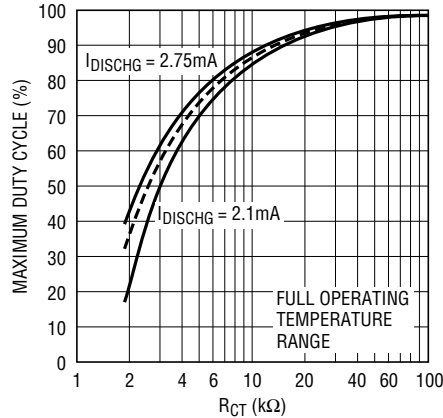

1680 G20

**Operating Frequency (Normalized) vs Temperature**

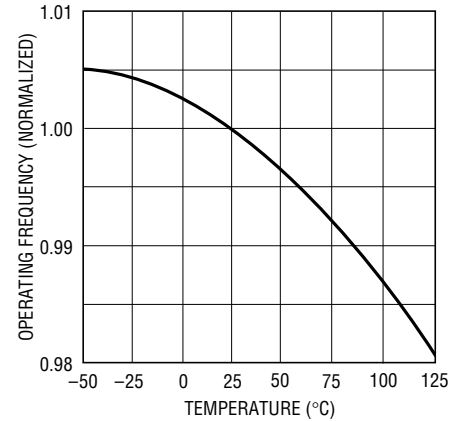

1680 G21

## PIN FUNCTIONS

**SL/ADJ (Pin 1):** Slope Compensation Adjustment. Allows increased slope compensation for certain high duty cycle applications. Resistive loading of this pin increases effective slope compensation. A resistor divider from the  $5V_{REF}$  pin can tailor the onset of additional slope compensation to specific regions in each switch cycle. Pin can be floated or connected to  $5V_{REF}$  if no additional slope compensation is required. (See Applications Information section for slope compensation details.)

**$C_T$  (Pin 2):** Oscillator Timing Pin. Connect a capacitor ( $C_T$ ) to ground and a pull-up resistor ( $R_{CT}$ ) to the  $5V_{REF}$  supply. Typical values are  $C_T = 1000\text{pF}$  and  $10\text{k} \leq R_{CT} \leq 30\text{k}$ .

**$I_{AVG}$  (Pin 3):** Average Current Limit Integration. Frequency response characteristic is set using the  $50\text{k}\Omega$  output impedance and external capacitor to ground. Averaging roll-off is typically set 1 to 2 orders of magnitude below switching frequency. (Typical capacitor value =  $1000\text{pF}$  for  $f_0 = 100\text{kHz}$ .) Shorting this pin to SGND will disable the average current limit function. In systems where open-loop inductor current occurs, such as boost supplies during output short-circuit condition and inrush periods, an external small-signal protection diode should be connected between  $I_{AVG}$  and the  $V_C$  pin (anode to  $I_{AVG}$  pin, cathode to  $V_C$  pin). See Applications Information.

**SS (Pin 4):** Soft Start. Generates ramping threshold for regulator current limit during start-up and after UVLO events by sourcing about  $10\mu\text{A}$  into an external capacitor.

**$V_C$  (Pin 5):** Error Amplifier Output. RC load creates dominant compensation in power supply regulation feedback loop to provide optimum transient response. (See Applications Information section for compensation details.)

**SGND (Pin 6):** Small-Signal Ground. Connect to negative terminal of  $C_{OUT}$ .

**$V_{FB}$  (Pin 7):** Error Amplifier Inverting Input. Used as voltage feedback input node for regulator loop. Pin sources about  $0.5\mu\text{A}$  DC bias current to protect from an open feedback path condition.

**$V_{REF}$  (Pin 8):** Bandgap Generated Voltage Reference Decoupling. Connect a capacitor to signal ground. (Typical capacitor value  $\approx 0.1\mu\text{F}$ .)

**SENSE+ (Pin 9):** Current Sense Amplifier Inverting Input. Connect to most positive (DC) terminal of current sense resistor.

**SENSE- (Pin 10):** Current Sense Amplifier Noninverting Input. Connect to most negative (DC) terminal of current sense resistor.

## PIN FUNCTIONS

**RUN/SHDN (Pin 11):** Precision Referenced Shutdown. Can be used as logic level input for shutdown control or as an analog monitor for input supply undervoltage protection, etc. IC is enabled when RUN/SHDN pin rising edge exceeds 1.25V. 15mV of hysteresis helps assure stable mode switching. All internal functions are disabled in shutdown mode. If this function is not desired, connect RUN/SHDN to 12V<sub>IN</sub> (typically through a 100k resistor). See Applications Information.

**PGND (Pin 12):** Power Ground. References the output switch and internal driver control circuits. Connect with low impedance trace to V<sub>IN</sub> decoupling capacitor negative (ground) terminal.

**GATE (Pin 13):** Driver Output. Connect to gate of external power FET switch.

**12V<sub>IN</sub> (Pin 14):** 12V Power Supply Input. Bypass with at least 1μF to PGND.

**SYNC (Pin 15):** Oscillator Synchronization Pin with TTL-Level Compatible Input. Input drives internal rising edge triggered one shot; SYNC signal on/off times should be ≥1μs (10% to 90% duty cycle at 100kHz). Does not contain internal pull-up. Connect to SGND if not used.

**5V<sub>REF</sub> (Pin 16):** 5V Reference Output. Allows connection of external loads up to 10mA DC. Reference is not available during shutdown. Typically bypassed with at least 1μF capacitor to SGND.

## BLOCK DIAGRAM

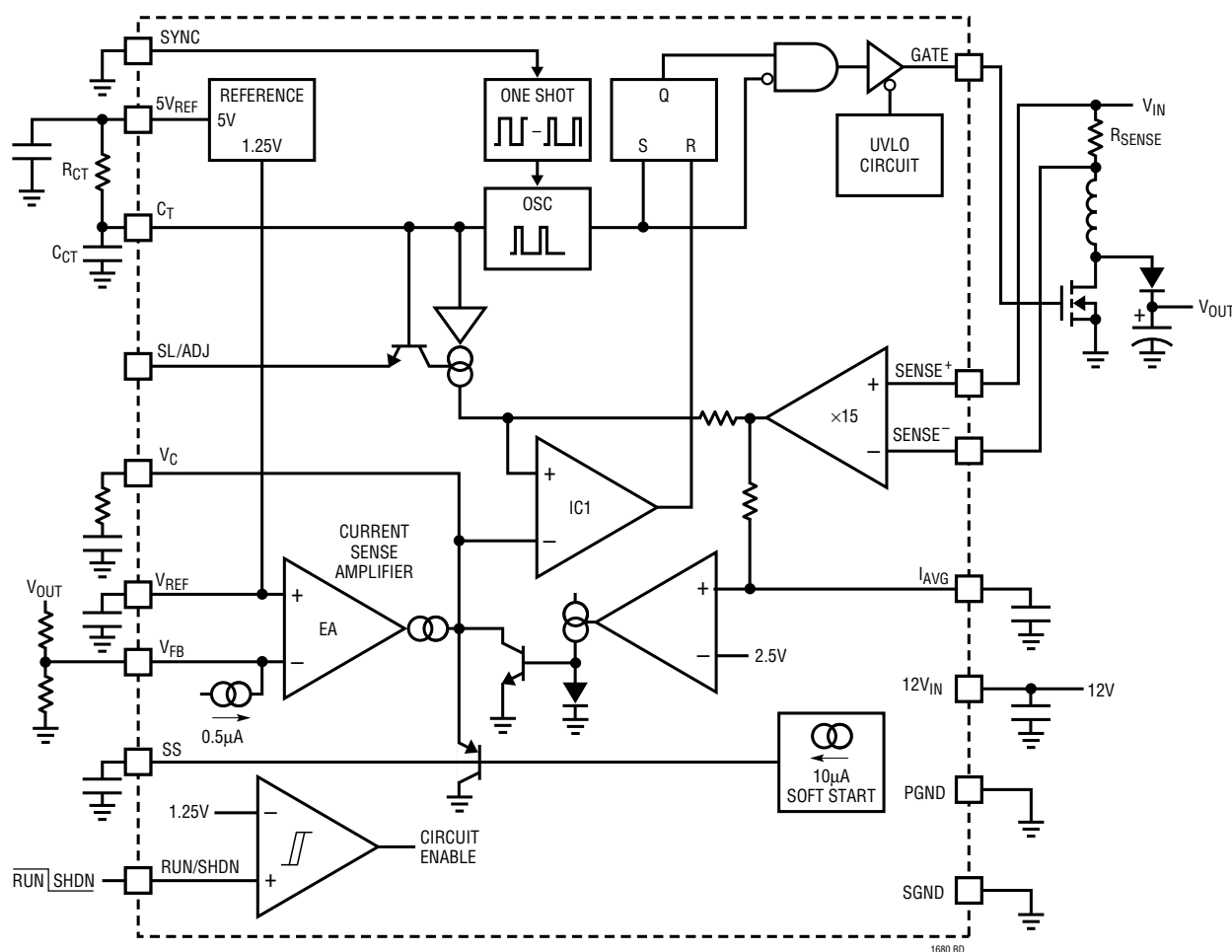



## OPERATION

### Basic Control Loop

The LT1680 uses a constant frequency, current mode architecture. The timing of the IC is provided through an internal oscillator circuit that can be synchronized to an external clock and is programmable to operate at frequencies up to 200kHz. The oscillator creates a modified sawtooth wave at its timing node ( $C_T$ ) with a slow charge, rapid discharge characteristic.

During typical boost converter operation, the MOSFET switch is enabled at the start of each oscillator cycle. The switch stays enabled until the current through the switched inductor, sensed via the voltage across a series sense resistor ( $R_{SENSE}$ ), is sufficient to trip the current comparator (IC1) and reset the RS latch. When the switch is disabled, the inductor current is redirected to the supply output. If the current comparator threshold is not reached throughout the entire oscillator charge period, the RS latch is bypassed and the main switch is disabled during the oscillator discharge time. This “minimum off time” protects the switch, and is typically about 1 $\mu$ s.

The current comparator trip threshold is set on the  $V_C$  pin, which is the output of a transconductance amplifier, or error amplifier (EA). The error amplifier integrates the difference between a feedback voltage (on the  $V_{FB}$  pin) and an internal bandgap generated reference voltage of 1.25V, forming a signal that represents required load current. If the supplied current is insufficient for a given load, the output will droop, thus reducing the feedback voltage. The error amplifier responds by forcing current out of the  $V_C$  pin, increasing the current comparator threshold. Thus, the circuit will servo until the provided current is equal to the required load and the average output voltage is at the value programmed by the feedback resistors.

### Input Average Current Limit

The output of the sense amplifier is monitored by a single pole integrator comprised of an external capacitor on the  $I_{AVG}$  pin and an output impedance of approximately 50k $\Omega$ . If this averaged value signal exceeds a level corresponding to 120mV across the external sense resistor, the current comparator threshold is clamped and cannot continue to rise in response to the error amplifier. Thus, if average input current requirements exceed 120mV/ $R_{SENSE}$ , the

supply will current limit and the output voltage will fall out of regulation. The average current limit circuit monitors the sense amplifier output without slope compensation or ripple current contributions. Therefore, the average input current limit threshold is unaffected by duty cycle.

### Undervoltage Lockout

The LT1680 employs an undervoltage lockout circuit (UVLO) that monitors the 12V $_{IN}$  supply rail. This circuit disables the output drive capability of the LT1680 if the 12V supply drops below 9V. Unstable mode switching is prevented through 350mV of UVLO threshold hysteresis.

### Shutdown

The LT1680 can be put into low current shutdown by pulling the RUN/SHDN pin low, disabling all circuit functions. The shutdown threshold is a bandgap referred voltage of 1.25V typical. Use of a precision threshold on the shutdown circuit enables use of this pin for undervoltage protection of the  $V_{IN}$  supply and/or power supply sequencing.

### Soft Start

The LT1680 incorporates a soft start function that operates by slowly increasing current limit. This limit is controlled by internally clamping the  $V_C$  pin to a low voltage that climbs with time as an external capacitor on the SS pin is charged with about 10 $\mu$ A. This forces a graceful climb of output current source capability, and thus a graceful increase in output voltage until steady-state regulation is achieved. The soft start timing capacitor is clamped to ground during shutdown and during undervoltage lockout, yielding a graceful output recovery from either condition.

### 5V Internal Reference

Power for the oscillator timing elements and most other internal LT1680 circuits is derived from an internal 5V reference, accessible at the 5V $_{REF}$  pin. This supply pin can be loaded with up to 10mA DC (20mA pulsed) for convenient biasing of local elements such as control logic, etc.



## OPERATION

### Slope Compensation

For duty cycles greater than 50%, slope compensation is required to prevent current mode duty cycle instability in the regulator control loop. The LT1680 employs internal slope compensation that is adequate for most applica-

tions. However, if additional slope compensation is desired, it is available through the SL/ADJ pin. Excessive slope compensation will cause reduction in maximum load current capability and is generally not desirable.

## APPLICATIONS INFORMATION

### R<sub>SENSE</sub> Selection for Input Current Limit

R<sub>SENSE</sub> generates a voltage that is proportional to the inductor current for use by the LT1680 current sense amplifier. The value of R<sub>SENSE</sub> is based on the required input current. The average current limit function has a typical threshold of 120mV/R<sub>SENSE</sub>, or:

$$R_{SENSE} = 120\text{mV}/I_{LIMIT}$$

Operation with V<sub>SENSE</sub> common mode voltage below 4.5V may slightly degrade current limit accuracy. See Average Current Limit Threshold Tolerance vs Common Mode Voltage in the Typical Performance Characteristics section for more information.

### Output Voltage Programming

Output voltage is programmed through a resistor feedback network to the V<sub>FB</sub> pin (Pin 7) on the LT1680. This pin is the inverting input of the error amplifier, which is internally referenced to 1.25V. The divider is ratioed to provide 1.25V at the V<sub>FB</sub> pin when the output is at its desired value. Output voltage is thus set following the relation:

$$V_{OUT} = 1.25V(1 + R2/R1)$$

when an external resistor divider is connected to the output as shown in Figure 1.

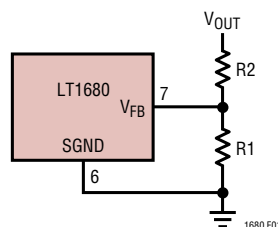

Figure 1. Programming LT1680 Output Voltage

If high value feedback resistors are used, the input bias current of the V<sub>FB</sub> pin (1μA maximum) could cause a slight increase in output voltage. A Thevenin resistance at the V<sub>FB</sub> pin of <5k is recommended.

### Oscillator Components R<sub>CT</sub> and C<sub>CT</sub>

The LT1680 oscillator creates a modified sawtooth at its timing node (C<sub>T</sub>) with a slow charge, rapid discharge characteristic. The discharge time (t<sub>DISCH</sub>) corresponds to the minimum off time of the PWM controller. This limits maximum duty cycle (DC<sub>MAX</sub>) to:

$$DC_{MAX} = 1 - (t_{DISCH})(f_0)$$

This relation corresponds to the minimum value of the timing resistor (R<sub>CT</sub>), which can be determined according to the following relation (R<sub>CT</sub> vs DC<sub>MAX</sub> graph appears in the Typical Performance Characteristics section):

$$R_{CT(MIN)} \approx [(0.8)(10^{-3})(1 - DC_{MAX})]^{-1}$$

Values for R<sub>CT</sub> > 15k yield maximum duty cycles above 90%. Given a timing resistor value, the value of the timing capacitor (C<sub>CT</sub>) can then be determined for desired operating frequency (f<sub>0</sub>) using the relation:

$$C_{CT} \approx \frac{(1/f_0) - (100)(10^{-9})}{(R_{CT}/1.85) + \frac{1.75}{(2.5)(10^{-3}) - (3.375/R_{CT})}}$$

A plot of Operating Frequency vs R<sub>CT</sub> and C<sub>CT</sub> is shown in Figure 2. Typical 100kHz operational values are C<sub>CT</sub> = 1000pF and R<sub>CT</sub> = 16.9k.

**APPLICATIONS INFORMATION**

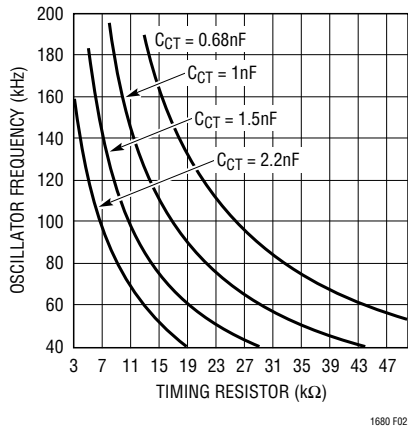

**Figure 2. Operating Frequency vs  $R_{CT}$ ,  $C_{CT}$**

**Average Current Limit**

The average current limit function is implemented using an external capacitor ( $C_{AVG}$ ) connected from  $I_{AVG}$  to SGND. This capacitor forms a single pole integrator with the 50kΩ output impedance of the  $I_{AVG}$  pin. The integrator corner frequency is typically set 1 to 2 orders of magnitude below the oscillator frequency and follows the relation:

$$f_{-3dB} = (3.2)(10^{-6})/C_{AVG}$$

The average current limit function can be disabled by shorting the  $I_{AVG}$  pin directly to SGND. In some applications it is theoretically possible for the average current limit circuit to overdrive the error amplifier output ( $V_C$  pin) beyond the operating range of the current sense comparator. These applications include those where open-loop system operation occurs, such as boost regulators in output short-circuit condition, or in systems with poor signal ground integrity. The potential for this overdrive can be eliminated by connecting an external clamp diode between the  $I_{AVG}$  and  $V_C$  pins (anode to  $I_{AVG}$  and cathode to  $V_C$ ). Connection of this diode will have no adverse effects in any system and is recommended. This clamp is required for all boost converter topologies.

**Soft Start Programming**

The LT1680 current control pin ( $V_C$ ) limits inductor current to zero at voltages less than  $\approx 0.7V$  through full average current limit at  $V_C \approx 2.5V$ , yielding 1.8V over the full regulation range of average load current. With the SS pin at 0V, the  $V_C$  pin is clamped to its zero inductor current level. Given the typical soft start charge current of 10μA

and a soft start timing capacitor  $C_{SS}$ , the start-up delay time to full available average current will be:

$$t_{SS} = (1.8)(10^5)(C_{SS})$$

**Shutdown Function—Input Undervoltage Detect and Threshold Hysteresis**

The LT1680 RUN/SHDN pin uses a bandgap generated reference threshold of about 1.25V. This precision threshold allows use of the RUN/SHDN pin for both logic-level shutdown applications and analog monitoring applications such as power supply sequencing.

Because an LT1680 controlled converter is a power transfer device, a voltage that is lower than expected on the input supply could require currents that exceed the sourcing capabilities of that supply, causing the system to lock-up in an undervoltage state. Input supply start-up protection can be achieved by enabling the RUN/SHDN pin using a resistor divider from the input supply to ground. Setting the divider output to 1.25V when the supply is almost fully enabled prevents the LT1680 regulator from drawing large currents until the input supply is able to supply the required power.

If additional hysteresis is desired for the enable function, an external feedback resistor can be used from the LT1680 regulator output. If connection to the regulator output is not desired, the 5V<sub>REF</sub> internal supply pin can be used. Figure 3 shows an input supply sequencing configuration on a 24V input converter. This configuration yields an enable condition of 90%  $V_{IN}$  ( $\sim 21.5V$ ) with about 10% threshold hysteresis.

The shutdown function can be disabled by connecting the RUN/SHDN pin to the 12V<sub>IN</sub> rail. This pin is internally clamped to 2.5V through a 20k series input resistance and will therefore draw 0.5mA when tied directly to 12V. This

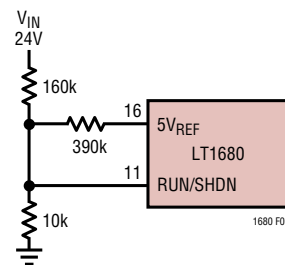

**Figure 3. Input Supply Sequencing Programming**

## APPLICATIONS INFORMATION

additional current can be minimized by making the connection through an external resistor (100k is typically used).

When shutting down the LT1680, the RUN/SHDN pin voltage must remain between the shutdown threshold (~1.13V) and a minimum shutdown control limit voltage (see Figure 4) for a least 25μs. If a digital input or fast moving clamp is used, this can be achieved by forcing a shutdown control voltage above the minimum limit or by using a simple integrator to increase the fall time of the input signal. A single pole integrator stage must have a  $\tau \geq (7)(10^{-5})$ .

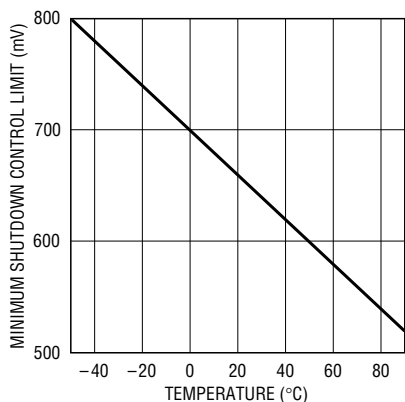

Figure 4. Minimum Shutdown Control Limit vs Temperature

Figure 5 is an example of a digital control input clamp. A logic high signal pulls the RUN/SHDN pin above its turn-on threshold through the diode. When a shutdown (logic low) signal is received, the RUN/SHDN pin is forced to 0.95V via the resistor divider until shutdown is fully established and the 5V<sub>REF</sub> voltage collapses.

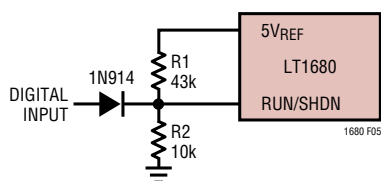

Figure 5. Digital Input Shutdown Level Control

Figure 6 is an example of a digital control integration stage at the RUN/SHDN input. The integrator has a  $\tau = (10)(10^3) \cdot (10)(10^{-9}) = (1.0)(10^{-4})$ . This circuit technique, however, delays initiation of controller shutdown about 125μs from the reception of the shutdown signal (5V – 0V transition).

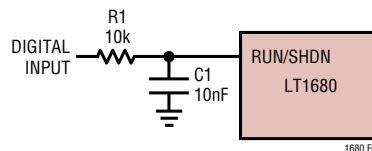

Figure 6. Digital Input Shutdown Integration Control

Figure 7 is an example of an integrator stage coupled with a 24V input power supply sequencing circuit similar to that shown in Figure 3. The integrator stage allows use of an active shutdown clamp for implementation of both user-controlled shutdown and input power supply sequencing protection.

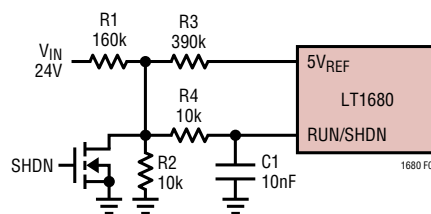

Figure 7. Input Supply Sequencing with User-Controlled Shutdown

### Oscillator Synchronization

The LT1680 oscillator generates a modified sawtooth waveform at the C<sub>T</sub> pin between low and high thresholds of 0.8V (vl) and 2.5V (vh) respectively. The oscillator can be synchronized by driving a TTL level pulse into the SYNC pin. This pin connects to a one shot circuit that reduces the oscillator high threshold to 2V for about 200ns. The SYNC input signal should have minimum on/off times of ≥1μs.

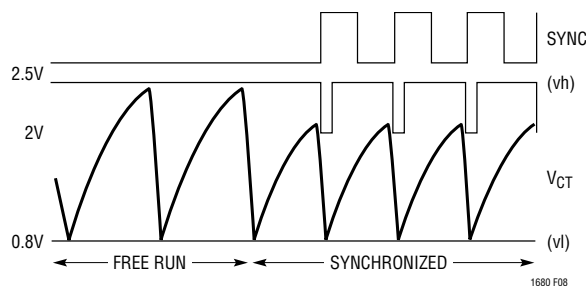

Figure 8. Free Run and Synchronized Oscillator Waveforms (at C<sub>T</sub> Pin)

### Inductor Selection

The inductor for an LT1680 converter is selected based on output power, operating frequency and efficiency require-

## APPLICATIONS INFORMATION

ments. Generally, the selection of inductor value can be reduced to desired maximum ripple current in the inductor ( $\Delta I$ ). For a boost converter, the minimum inductor value for a given operating ripple current can be determined using the following relation:

$$L_{MIN} = \frac{V_{IN}(V_{OUT} - V_{IN})}{(\Delta I)(f_0)(V_{OUT})}$$

Given an inductor value ( $L$ ), the peak inductor current is the sum of the average inductor current ( $I_{AVG}$ ) and half the inductor ripple current ( $\Delta I$ ), or:

$$I_{PK} = I_{AVG} + \frac{V_{IN}(V_{OUT} - V_{IN})}{(2)(L)(f_0)(V_{OUT})}$$

The inductor core type is determined by peak current and efficiency requirements. The inductor core must withstand this peak current without saturating, and the series winding resistance and core losses should be kept as small as is practical to maximize conversion efficiency.

The LT1680 peak current threshold is 40% greater than the average limit threshold. Slope compensation effects reduce this margin as duty cycle increases. This margin must be maintained to prevent peak current limit from corrupting the programmed value for average current limit. Programming the peak ripple current to less than 15% of the desired average current limit value will assure proper operation of the average current limit feature through 90% duty cycle (see Slope Compensation).

### Slope Compensation

Current mode switching regulators that operate with a duty cycle greater than 50% and have continuous inductor current can exhibit duty cycle instability. While a regulator will not be damaged and may even continue to function acceptably during this type of subharmonic oscillation, an irritating high-pitched squeal is usually produced.

The criterion for current mode duty cycle instability is met when the increasing slope of the inductor ripple current is less than the decreasing slope, which is the case at duty cycles greater than 50%. This condition is illustrated in Figure 9a. The inductor ripple current starts

at  $I_1$ , the beginning of each oscillator switch cycle. Current increases at a rate  $S1$  until the current reaches the control trip level  $I_2$ . The controller servo loop then disables the switch and inductor current begins to decrease at a rate  $S2$ . If the current switch point ( $I_2$ ) is perturbed slightly and increased by  $\Delta I$ , the cycle time ends such that the minimum current point is increased by a factor of  $1 + (S2/S1)$  to start the next cycle. On each successive cycle, this error is multiplied by a factor of  $S2/S1$ . Therefore, if  $S2/S1$  is  $\geq 1$ , the system is unstable.

Subharmonic oscillations can be eliminated by augmenting the increasing ripple current slope ( $S1$ ) in the control loop. This is accomplished by adding an artificial ramp on the inductor current waveform internal to the IC (with a slope  $S_X$ ) as shown in Figure 9b. If the sum of the slopes  $S1 + S_X$  is greater than  $S2$ , this condition for subharmonic oscillation no longer exists.

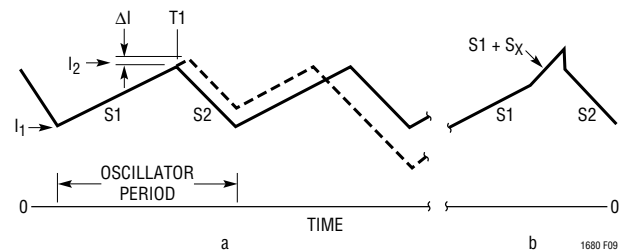

**Figure 9. Inductor Current at DC > 50% and Slope Compensation Adjusted Signal**

For boost topologies, the required additional current waveform slope, or “Slope Compensation,” follows the relation:

$$S_X \geq \frac{(S1)(2DC - 1)}{(1 - DC)}$$

For duty cycles less than 50% ( $DC < 0.5$ ),  $S_X$  is negative and is not required. For duty cycles greater than 50%,  $S_X$  takes on values dependent on  $S1$  and duty cycle.  $S1$  is simply  $V_{IN}/L$ . This leads to a minimum inductance requirement for a given  $V_{IN}$ , duty cycle and slope compensation ( $S_X$ ) of:

$$L_{MIN} = \frac{\left(\frac{V_{IN}}{S_X}\right)(2DC - 1)}{1 - DC}$$

The LT1680 contains an internal slope compensation ramp that has an equivalent current referred value of:

## APPLICATIONS INFORMATION

$$S_X = 0.084 \left( \frac{f_0}{R_{\text{SENSE}}} \right) \quad \text{Amp/s}$$

where  $f_0$  is oscillator frequency and  $R_{\text{SENSE}}$  is the external current sense resistor. This yields a minimum inductance requirement of:

$$L_{\text{MIN}} \geq \frac{(V_{\text{IN}})(R_{\text{SENSE}})(2\text{DC} - 1)}{[(0.084)(f_0)(1 - \text{DC})]}$$

A down side of slope compensation is that, since the IC servo loop senses an increase in perceived inductor current, the internal current limit functions are affected such that the maximum current capability of a regulator is reduced by the same amount as the effective current referred slope compensation. The LT1680, however, uses a current limit scheme that is independent of the slope compensation effects (Average Current Limiting). This provides operation at any duty cycle with no reduction in current sourcing capability, provided ripple current peak amplitude is less than 15% of the current limit value. For example, if the converter is set up to average current limit at 10A, as long as the peak inductor current is less than 11.5A, duty cycles up to 90% can be achieved without compromising the average current limit value.

If an inductor smaller than the minimum required for internal slope compensation (calculated above as  $L_{\text{MIN}}$ ) is desired, additional slope compensation is necessary. The LT1680 provides this capability through the SL/ADJ pin.

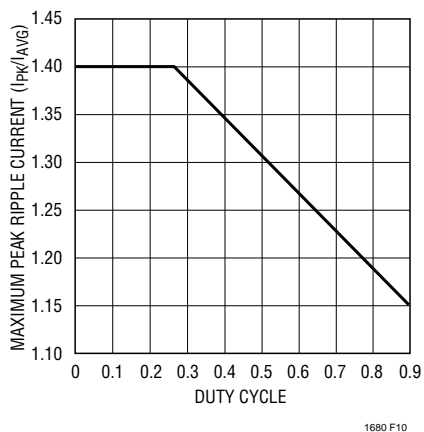

Figure 10. Maximum Peak Ripple Current (Normalized) vs Duty Cycle for Average Current Limit

This feature is implemented by referencing this pin via a resistor divider from the  $5V_{\text{REF}}$  pin to ground. The additional slope compensation will be affected at the point in the oscillator waveform (at pin  $C_T$ ) corresponding to the voltage set by the resistor divider. Additional slope compensation can be calculated using the relation:

$$S_X = \frac{(2500)(f_0)}{(R_{\text{TH}})(R_{\text{SENSE}})} \quad \text{Amp/s}$$

where  $R_{\text{TH}}$  is the Thevenin resistance of the resistor divider. Actual compensation will actually be somewhat greater due to internal curvature correction circuitry that imposes an exponential increase in the slope compensation waveform, further increasing the effective compensation slope up to 20% for a given setting.

Design example:

$$\begin{aligned} V_{\text{IN}} &= 20\text{V} \\ V_{\text{OUT}} &= 80\text{V} \quad (\text{DC} = 0.75) \\ R_{\text{SENSE}} &= 0.01\Omega \\ f_0 &= 100\text{kHz} \\ L &= 20\mu\text{H} \end{aligned}$$

The minimum inductor usable with no additional slope compensation is:

$$L_{\text{MIN}} \geq \frac{(20\text{V})(0.01\Omega)(1.5 - 1)}{(0.084)(100000)(1 - 0.75)} = 47.6\mu\text{H}$$

Since  $L = 20\mu\text{H}$  is less than  $L_{\text{MIN}}$ , additional slope compensation is necessary. The total slope compensation required is:

$$S_X \geq \frac{\left( \frac{20\text{V}}{20\mu\text{H}} \right) (1.5 - 1)}{1 - 0.75} = (2)(10^6) \quad \text{Amp/s}$$

Subtracting the internally generated slope compensation and solving for the required effective resistance at SL/ADJ yields:

$$R_{\text{EQ}} \leq \frac{(2500)(f_0)}{(2)(10^6)(R_{\text{SENSE}}) - (0.084)(f_0)} = 21.5\text{k}$$



## APPLICATIONS INFORMATION

Setting the resistor divider reference voltage to 2V assures that the additional compensation waveform will be enabled at a 75% duty cycle. As shown in Figure 11a, using  $R_{SL1} = 45k$  and  $R_{SL2} = 30k$  sets the desired reference voltage and has a  $R_{TH}$  of 18k, which meets both design requirements. Figure 11b shows the slope compensation effective waveforms both with and without the SL/ADJ external resistors.

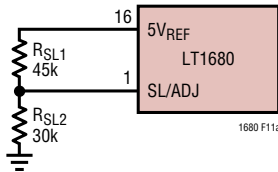

Figure 11a. External Slope Compensation Resistors

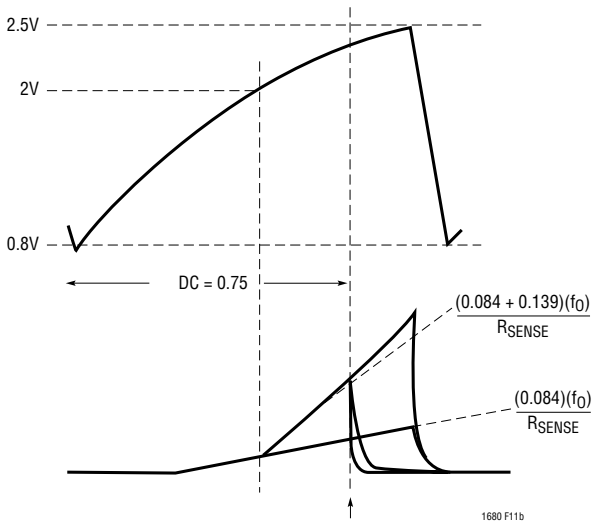

Figure 11b. Slope Compensation Waveforms

### Power MOSFET and Output Rectifying Diode Selection

LT1680 converter system parameters that dictate selection criteria for the switch MOSFET and output rectifying diode include maximum load current ( $I_{OUT}$ ), inductor average current ( $I_{AVG}$ ) and inductor ripple current ( $\Delta I$ ), and maximum input and output voltages.

The switch MOSFETs selected must have a maximum operating  $V_{DSS}$  exceeding the maximum output voltage ( $V_{OUT}$ ).  $V_{GS}$  rated operating maximums must exceed the  $12V_{IN}$  supply voltage. Once voltage requirements have been determined, switch conduction resistance ( $R_{DS(ON)}$ ) can be determined based on allowable power dissipation.

In a typical LT1680 boost converter, the switch current is equal to the inductor current, but is chopped according to duty cycle (DC). The conduction loss ( $P_{LOSS}$ ) for a given FET  $R_{DS(ON)}$  can be calculated using the relation:

$$P_{LOSS} \approx (DC)(R_{DS(ON)})(I_{AVG}^2 + [\Delta I^2/12])$$

where  $I_{AVG}$  = average inductor current and  $\Delta I$  = peak-to-peak inductor ripple current.

The output diode is often a major source of power loss in switching regulators and selection of adequately rated diodes is important. In a boost converter, when the output voltage is significantly higher than the input voltage, the peak diode current becomes much higher than average output currents and diode current ratings must be observed with caution. The peak diode current is:

$$I_{D(PEAK)} = I_{AVG} + \Delta I/2$$

and the average power dissipation ( $P_D$ ) in the diode is:

$$P_D = (I_{OUT})(V_f)$$

where  $V_f$  is the forward voltage of the diode at peak current. The output diode must also be rated for maximum reverse voltages exceeding  $V_{OUT}$ .

### $C_{IN}$ and $C_{OUT}$ Supply Decoupling Capacitor Selection

The large currents typical of LT1680 applications require special consideration for the regulator input and output supply decoupling capacitors.

Under normal steady state boost operation, output current provided by the converter is a square wave of duty cycle  $V_{IN}/V_{OUT}$ , the average value being equal to the required DC load current ( $I_{OUT}$ ). The continuity of the load current is maintained by the output bypass capacitors. To prevent excessive output voltage ripple and undue capacitor heating (and associated catastrophic failure), low ESR output capacitors sized for the maximum RMS current must be used. This maximum capacitor RMS current follows the relation:

$$I_{RMS} \approx I_{OUT} \left( \frac{V_{OUT}}{V_{IN}} - 1 \right)^{1/2}$$

Capacitor ripple current ratings are often based on only 2000 hours (3 months) lifetime; it is advisable to derate either the ESR or temperature rating of capacitors for increased MTBF.

## APPLICATIONS INFORMATION

The input bypass capacitors generally have less ripple current than the output bypass capacitors as the input current in a boost converter is continuous. Input bypass capacitor selection can be made using ripple current ratings. Peak-to-peak ripple current is equal to the inductor ripple current ( $\Delta I_L$ ).

### Efficiency Considerations and Heat Dissipation

High output power applications create an inherent concern regarding power dissipation in regulator components. Although high efficiencies are achieved using the LT1680, the power dissipated in the regulator climbs to relatively high values when the load draws large amounts of power. Even at 90% efficiency, a 500W application has conversion loss of 55W.

$I^2R$  dissipation in the MOSFET switch, sense resistor and inductor series resistance can generate substantial conversion loss under high current conditions. Generally, the dominant  $I^2R$  loss is evidenced in the FET switch, which is proportional to the steady-state duty cycle, or conduction time of the switch. For example, in a 5V to 48V boost converter, the duty cycle is:

$$DC = 1 - (V_{IN}/V_{OUT})$$

$$DC = 1 - 5/48 \approx 90\%$$

The FET switch conducts inductor current for almost 90% of the cycle time, and thus may require increased consideration for dissipating  $I^2R$  power.

### Gate Drive Buffer

The LT1680 is designed to drive relatively large capacitive loads. However, in certain applications, efficiency improvements can be realized by adding an external buffer stage to drive the gate of the FET switch. When the switch gate loads the driver output such that rise/fall times exceed 100ns, buffers can sometimes result in efficiency gains. Buffers can also reduce effects of back injection into the gate driver output due to coupling of switch node transitions through the switch FET  $C_{MILLER}$ .

### Optimizing Transient Response— Compensation Component Values

The dominant compensation point for an LT1680 converter is the  $V_C$  pin (Pin 5), or error amplifier output. This pin connects to an external series RC network,  $R_{VC}$  and  $C_{VC}$ . The infinite permutations of input/output filtering, capacitor ESR, input voltage, load current, etc. make for an empirical method of optimizing loop response for a specific set of conditions.

Loop response can be observed by injecting a step change in load current. This can be achieved by using a switchable load. With the load switching, the transient response of the output voltage can be observed with an oscilloscope. Iterating through RC combinations will yield optimized response. Refer to Application Note 19 in the *1990 Linear Applications Handbook, Volume 1* for more information.

## PACKAGE DESCRIPTION Dimensions in inches (millimeters) unless otherwise noted.

**N Package**  
**16-Lead PDIP (Narrow 0.300)**  
 (LTC DWG # 05-08-1510)

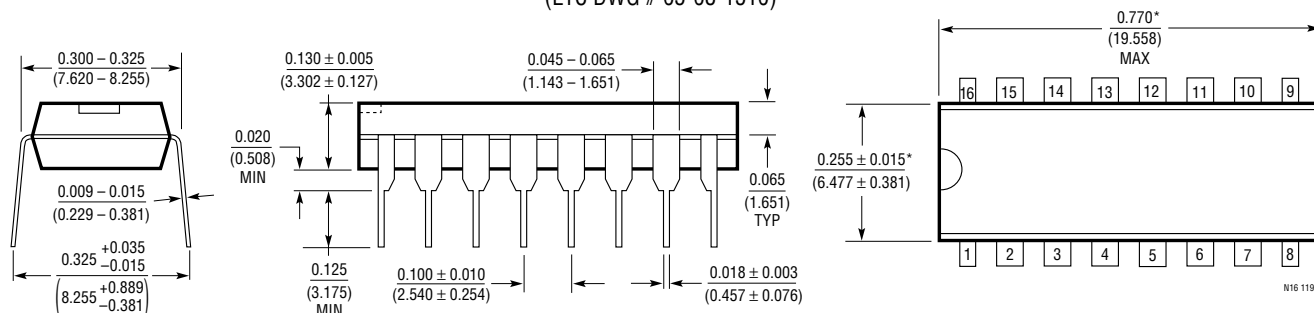

\*THESE DIMENSIONS DO NOT INCLUDE MOLD FLASH OR PROTRUSIONS.  
 MOLD FLASH OR PROTRUSIONS SHALL NOT EXCEED 0.010 INCH (0.254mm)



**TYPICAL APPLICATION**

-48V to 5V 30W Forward Converter

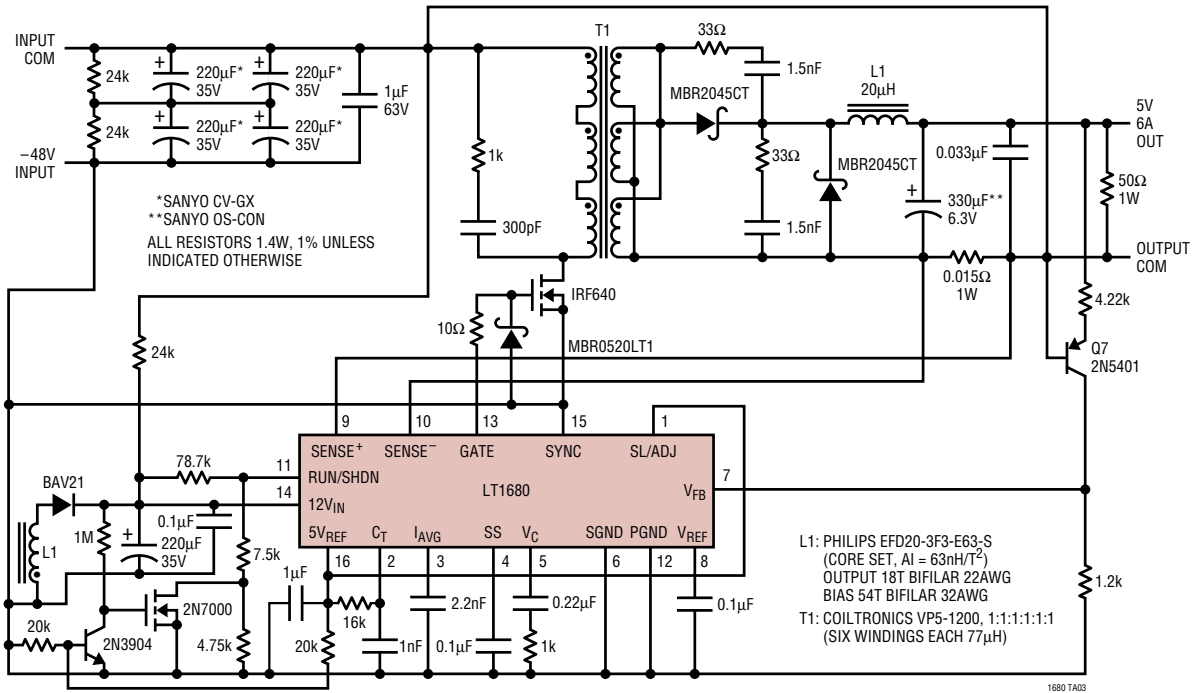

**PACKAGE DESCRIPTION** Dimensions in inches (millimeters) unless otherwise noted.

**SW Package**  
**16-Lead Plastic Small Outline (Wide 0.300)**  
 (LTC DWG # 05-08-1620)

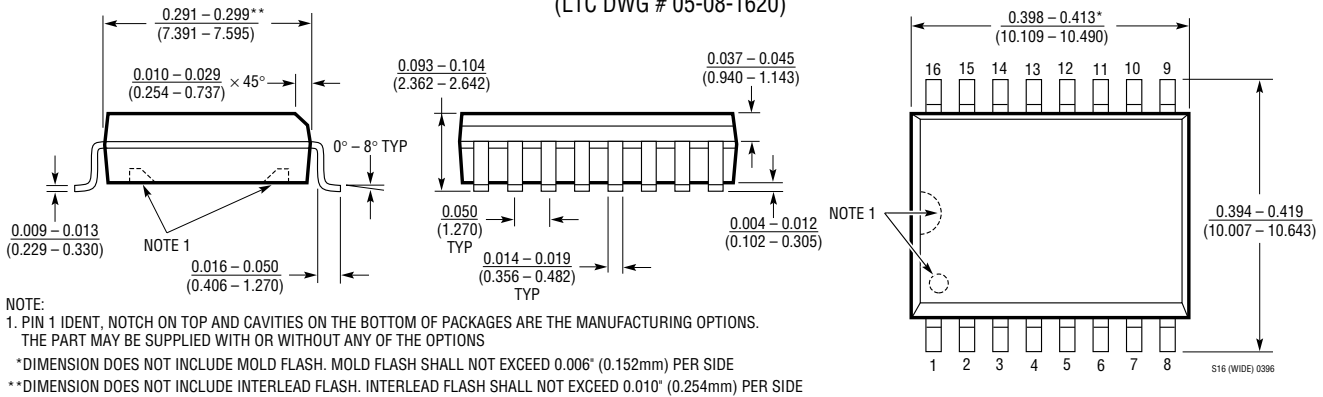

**RELATED PARTS**

PART NUMBER	DESCRIPTION	COMMENTS
LT1268	7.5A, 150kHz Switching Regulator	Integrated Switch Can Be Used in Isolated Flyback Mode
LT1270A	10A, 60kHz Switching Regulator	Integrated Switch Can Be Used in Isolated Flyback Mode
LT1339	High Power Synchronous DC/DC Controller	Operation to 60V, No Shoot-Through N-Channel Output Drivers
LT1370	500kHz, 6A Boost Switching Regulator	Integrated Switch, Regulates Positive or Negative Outputs
LT1371	500kHz, 3A Boost Switching Regulator	Integrated Switch, Regulates Positive or Negative Outputs