

LT1007, LT1007A, LT1037, LT1037A LOW-NOISE, HIGH-SPEED, PRECISION OPERATIONAL AMPLIFIERS

SLOS017C – D3195, FEBRUARY 1989 – REVISED JANUARY 1993

- **Maximum Equivalent Input Noise Voltage:**
3.8 nV/√Hz at 1 kHz
4.5 nV/√Hz at 10 Hz
- **Low Peak-to-Peak Equivalent Input Noise Voltage:** 60 nV Typ From 0.1 Hz to 10 Hz
- **Slew Rate (LT1037 and LT1037A):**
11 V/μs Min

LT1007A and LT1037A Specifications:

- **High Voltage Amplification:**
7 V/μV Min, R_L = 2 kΩ
3 V/μV Min, R_L = 600 Ω
- **Low Input Offset Voltage:**
25 μV Max
- **Low Input Offset Voltage Temperature Coefficient:** 0.6 μV/°C Max
- **Common-Mode Rejection Ratio:** 117 dB Min

description

These monolithic operational amplifiers feature extremely low-noise performance and outstanding precision and speed specifications. The typical differential voltage amplification (at T_A = 25°C) of these devices is an extremely high 20 V/μV driving a 2-kΩ load to ±12 V and 12 V/μV driving, a 600-Ω load to ±10V.

In the design, processing, and testing of the device, particular attention has been paid to the optimization of the entire distribution of several key parameters. Consequently, the specifications of even the lowest-cost grades (the LT1007C and the LT1037C) have been greatly improved compared to equivalent grades of competing amplifiers.

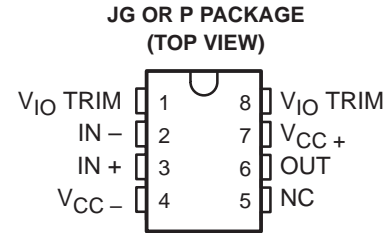
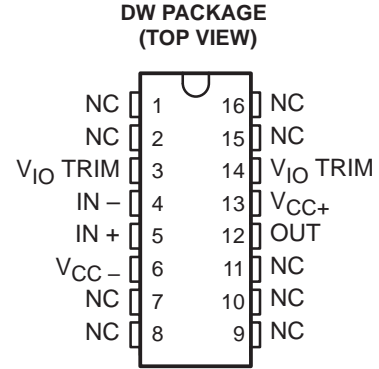

NC – No internal connection

AVAILABLE OPTIONS

T _A	V _{IO} max AT 25°C	PACKAGE		
		SMALL-OUTLINE (DW)	CERAMIC DIP (JG)	PLASTIC DIP (P)
0°C to 70°C	60 μV	LT1007CDW	—	LT1007CP
	25 μV	—	—	LT1007ACP
	60 μV	LT1037CDW	—	LT1037CP
	25 μV	—	—	LT1037ACP
–55°C to 125°C	60 μV	—	LT1007MJG	LT1007MP
	25 μV	—	LT1007AMJG	LT1007AMP
	60 μV	—	LT1037MJG	LT1037MP
	25 μV	—	LT1037AMJG	LT1037AMP

The DW packages are available taped and reeled. Add the suffix R to the device type, (e.g., LT1007CDWR).

schematic

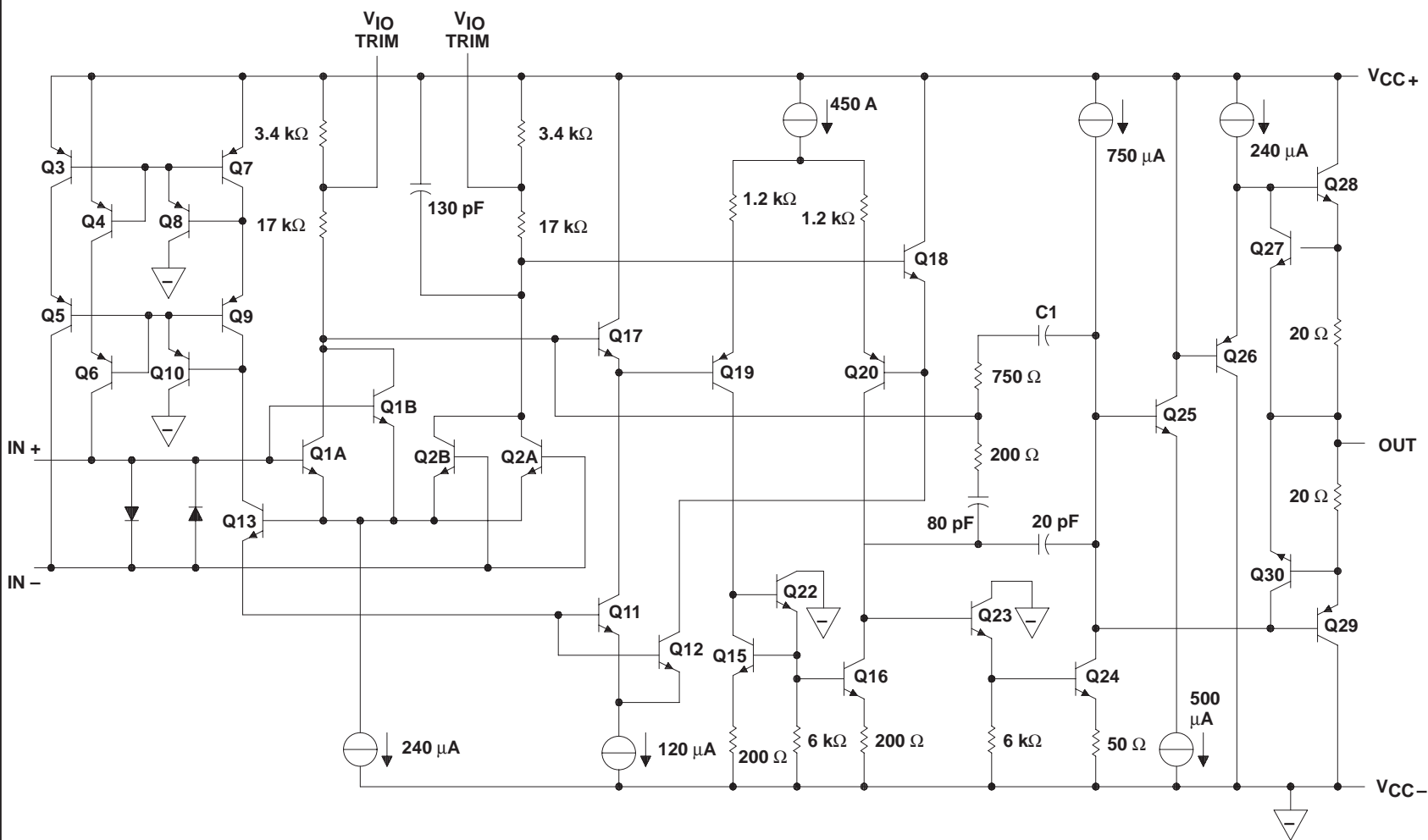

C1 = 110 pF for LT1007

C1 = 12 pF for LT1037

All component values shown are nominal.

LT1007, LT1007A, LT1037, LT1037A

LOW-NOISE, HIGH-SPEED, PRECISION OPERATIONAL AMPLIFIERS

SLOS017C – D3195, FEBRUARY 1989 – REVISED JANUARY 1993

absolute maximum ratings over operating free-air temperature range (unless otherwise noted)

Supply voltage, V_{CC+} (see Note 1)	22 V
Supply voltage, V_{CC-}	–22 V
Input voltage	$V_{CC\pm}$
Duration of output short circuit	Unlimited
Differential input current (see Note 2)	± 25 mA
Power dissipation	See Dissipation Rating Table
Operating free-air temperature range:	
LT1007C, LT1007AC, LT1037C, LT1037AC	0°C to 70°C
LT1007M, LT1007AM, LT1037M, LT1037AM	–55°C to 125°C
Storage temperature range	–65°C to 150°C
Lead temperature 1,6 mm (1/16 inch) from case for 10 seconds: DW and P packages	260°C
Lead temperature 1,6 mm (1/16 inch) from case for 60 seconds: JG package	300°C

- NOTES: 1. All voltage values, unless otherwise noted, are with respect to the midpoint between V_{CC+} and V_{CC-} .
2. The inputs are protected by back-to-back diodes. Current limiting resistors are not used in order to achieve low noise. Excessive input current will flow if a differential input voltage in excess of approximately ± 0.7 V is applied between the inputs, unless some limiting resistance is used.

DISSIPATION RATING TABLE

PACKAGE	$T_A \leq 25^\circ\text{C}$	DERATING FACTOR	$T_A = 70^\circ\text{C}$	$T_A = 125^\circ\text{C}$
	POWER RATING	ABOVE $T_A = 25^\circ\text{C}$	POWER RATING	POWER RATING
DW	1025 mW	8.2 mW/°C	656 mW	N/A
JG	1050 mW	8.4 mW/°C	672 mW	210 mW
P	1000 mW	8 mW/°C	640 mW	200 mW

recommended operating conditions

	C-SUFFIX			M-SUFFIX			UNIT
	MIN	NOM	MAX	MIN	NOM	MAX	
Supply voltage, V_{CC+}	4	15	22	4	15	22	V
Supply voltage, V_{CC-}	–4	–15	–22	–4	–15	–22	V
Input voltage, V_I	$T_A = 25^\circ\text{C}$			± 11			V
	$T_A = \text{full range}$			± 10.3			V
Operating free-air temperature, T_A	0		70	–55		125	°C



LT1007, LT1007A, LT1037, LT1037A LOW-NOISE, HIGH-SPEED, PRECISION OPERATIONAL AMPLIFIERS

SLOS017C – D3195, FEBRUARY 1989 – REVISED JANUARY 1993

electrical characteristics, $V_{CC\pm} = \pm 15\text{ V}$

PARAMETER	TEST CONDITIONS	T_A	LT1007C, LT1037C			LT1007AC, LT1037AC			UNIT	
			MIN	TYP	MAX	MIN	TYP	MAX		
V_{IO}	Input offset voltage	See Note 3	25°C		20	60	10		25	μV
			0°C to 70°C		110			50		
α_{VIO}	Average temperature coefficient of input offset voltage	0°C to 70°C	1			0.6			$\mu\text{V}/^\circ\text{C}$	
I_{IO}	Input offset current	25°C	12		50	7		30	nA	
		0°C to 70°C	70			40				
I_{IB}	Input bias current	25°C	± 15		± 55	± 10		± 35	nA	
		0°C to 70°C	± 75			± 45				
V_{OM}	Peak output voltage swing	$R_L = 2\text{ k}\Omega$	25°C	± 12.5	± 13.5	± 13		± 13.8	V	
		$R_L = 600\ \Omega$	25°C	± 10.5	± 12.5	± 11		± 12.5		
		$R_L = 2\text{ k}\Omega$	0°C to 70°C	± 12		± 12.5				
A_{VD}	Large-signal differential voltage amplification	$R_L \geq 2\text{ k}\Omega, V_O = \pm 12\text{ V}$	25°C	5	20	7		20	V/ μV	
		$R_L \geq 1\ \Omega, V_O = \pm 10\text{ V}$	25°C	3.5	16	5		16		
		$R_L \geq 600\ \Omega, V_O = \pm 10\text{ V}$	25°C	2	12	3		12		
		$R_L \geq 2\text{ k}\Omega, V_O = \pm 10\text{ V}$	0°C to 70°C	2.5		4				
		$R_L \geq 1\text{ k}\Omega, V_O = \pm 10\text{ V}$	0°C to 70°C	2		2.5				
$r_{i(CM)}$	Common-mode input resistance	25°C	5			7		$\text{G}\Omega$		
r_o	Open-loop output resistance	25°C	70			70		Ω		
CMRR	Common-mode rejection ratio	$V_{IC} = \pm 11\text{ V}$	25°C	110	126	117		130	dB	
		$V_{IC} = \pm 10.5\text{ V}$	0°C to 70°C	106			114			
k_{SVR}	Supply voltage rejection ratio	$V_{CC\pm} = \pm 4\text{ V to } \pm 18\text{ V}$	25°C	106	126	110		130	dB	
		$V_{CC\pm} = \pm 4.5\text{ V to } \pm 18\text{ V}$	0°C to 70°C	102			106			
P_D	Power dissipation	LT1007C, LT1007AC	25°C	80		140	80		120	mW
		LT1037C, LT1037AC	25°C	85		140	80		130	
			0°C to 70°C	160			144			

NOTE 3: V_{IO} measurements are performed by automatic test equipment approximately 0.5 seconds after application of power.

LT1007, LT1007A, LT1037, LT1037A

LOW-NOISE, HIGH-SPEED, PRECISION OPERATIONAL AMPLIFIERS

SLOS017C – D3195, FEBRUARY 1989 – REVISED JANUARY 1993

electrical characteristics, $V_{CC\pm} = \pm 15\text{ V}$

PARAMETER	TEST CONDITIONS	T_A	LT1007M, LT1037M			LT1007AM, LT1037AM			UNIT
			MIN	TYP	MAX	MIN	TYP	MAX	
V_{IO} Input offset voltage	See Note 3	25°C		20	60		10	25	μV
		-55°C to 125°C			160			60	
α_{VIO} Average temperature coefficient of input offset voltage		-55°C to 125°C			1			0.6	$\mu\text{V}/^\circ\text{C}$
I_{IO} Input offset current		25°C		12	50		7	30	nA
		-55°C to 125°C			85			50	
I_{IB} Input bias current		25°C		± 15	± 55		± 10	± 35	nA
		-55°C to 125°C			± 95			± 60	
V_{OM} Peak output voltage swing	$R_L = 2\text{ k}\Omega$	25°C	± 12.5	± 13.5		± 13	± 13.8	V	
	$R_L = 600\ \Omega$	25°C	± 10.5	± 12.5		± 11	± 12.5		
	$R_L = 2\text{ k}\Omega$	-55°C to 125°C	± 12			± 12.5			
A_{VD} Large-signal differential voltage amplification	$R_L \geq 2\text{ k}\Omega, V_O = \pm 12\text{ V}$	25°C	5	20		7	20	V/ μV	
	$R_L \geq 1\text{ k}\Omega, V_O = \pm 10\text{ V}$	25°C	3.5	16		5	16		
	$R_L \geq 600\ \Omega, V_O = \pm 10\text{ V}$	25°C	2	12		3	12		
	$R_L \geq 2\text{ k}\Omega, V_O = \pm 10\text{ V}$	-55°C to 125°C	2			3			
	$R_L \geq 1\text{ k}\Omega, V_O = \pm 10\text{ V}$	-55°C to 125°C	1.5			2			
$r_{i(CM)}$ Common-mode input resistance		25°C		5		7		$\text{G}\Omega$	
r_o Open-loop output resistance		25°C		70		70		Ω	
CMRR Common-mode rejection ratio	$V_{IC} = \pm 11\text{ V}$	25°C	110	126		117	130	dB	
	$V_{IC} = \pm 10.3\text{ V}$	-55°C to 125°C	104			112			
k_{SVR} Supply voltage rejection ratio	$V_{CC\pm} = \pm 4\text{ V to } \pm 18\text{ V}$	25°C	106	126		110	130	dB	
	$V_{CC\pm} = \pm 4.5\text{ V to } \pm 18\text{ V}$	-55°C to 125°C	100			104			
P_D Power dissipation	LT1007M, LT1007AM	25°C		80	140		80	120	mW
	LT1037M, LT1037AM	25°C		85	140		80	130	
		-55°C to 125°C			170			150	

NOTE 3: V_{IO} measurements are performed by automatic test equipment approximately 0.5 seconds after application of power.

LT1007, LT1007A, LT1037, LT1037A

LOW-NOISE, HIGH-SPEED, PRECISION OPERATIONAL AMPLIFIERS

SLOS017C – D3195, FEBRUARY 1989 – REVISED JANUARY 1993

operating characteristics, $V_{CC\pm} = \pm 15\text{ V}$, $T_A = 25^\circ\text{C}$

PARAMETER	TEST CONDITIONS	LT1007, LT1007A			LT1007, LT1007A			UNIT
		MIN	TYP	MAX	MIN	TYP	MAX	
SR	Slew rate	$R_L \geq 2\text{ k}\Omega$, $A_{VD} \geq 1$ (LT1007, LT1007A)		1.7	2.5	11	15	V/ μs
		$R_L \geq 2\text{ k}\Omega$, $A_{VD} \geq 5$ (LT1037, LT1037A)						
$V_{N(PP)}$	Peak-to-peak equivalent input noise voltage	f = 0.1 Hz to 10 Hz, See Note 4		0.06	0.13	0.06	0.13	μV
V_n	Equivalent input noise voltage	f = 10 Hz		2.8	4.5	2.8	4.5	nV/ $\sqrt{\text{Hz}}$
		f = 1 kHz		2.5	3.8	2.5	3.8	
I_n	Equivalent input noise current	f = 10 kHz, See Note 5		1.5	4	1.5	4	pA/ $\sqrt{\text{Hz}}$
		f = 1 kHz, See Note 5		0.4	0.6	0.4	0.6	
GBW	Gain bandwidth product	f = 100 kHz		5	8			MHz
		f = 10 kHz, $A_V \geq 15$				45	60	

- NOTES: 4. See the test circuit and frequency response curve for 0.1-Hz to 10-Hz noise (Figure 39) in the Applications Information section.
 5. See the test circuit for current noise measurement (Figure 40) in the Applications Information section.

LT1007, LT1007A, LT1037, LT1037A LOW-NOISE, HIGH-SPEED, PRECISION OPERATIONAL AMPLIFIERS

SLOS017C – D3195, FEBRUARY 1989 – REVISED JANUARY 1993

TYPICAL CHARACTERISTICS

table of graphs

			FIGURE
V_{IO}	Input offset voltage	vs Temperature	1
ΔV_{IO}	Change in input offset voltage	vs Time after power on	2
		vs Time (long-term stability)	3
I_{IO}	Input offset current	vs Temperature	4
I_{IB}	Input bias current	vs Temperature	5
	Common-mode limit voltage	over common-mode range	6
		vs Free-air temperature	7
V_{OM}	Maximum peak output voltage swing	vs Load resistance	8
		vs Frequency	9
A_{VD}	Differential voltage amplification	vs Frequency	10
		vs Frequency (LT1007)	11
		vs Frequency (LT1037)	12
		vs Temperature	13
		vs Load resistance	14
		vs Supply voltage	15
		at 2 k Ω and 600 Ω	16
V_{ID}	Differential input voltage	vs Output voltage	16
CMRR	Common-mode rejection ratio	vs Frequency	17
kSVR	Supply voltage rejection ratio	vs Frequency	18
SR	Slew rate	vs Free-air temperature (LT1007)	19
		vs Free-air temperature (LT1037)	20
ϕ	Phase shift	vs Frequency (LT1007)	11
		vs Frequency (LT1037)	12
ϕ_m	Phase margin	vs Free-air temperature (LT1007)	19
		vs Free-air temperature (LT1037)	20
V_n	Equivalent input noise voltage	vs Free-air temperature	21
		vs Time (0.01-Hz to 1-Hz noise)	22
		vs Frequency	23
		vs Bandwidth	24
		vs Supply voltage	25
I_n	Equivalent input noise current Total noise	vs Frequency	26
		vs Source resistance	27
GBW	Gain bandwidth product	vs Free-air Temperature (LT1007)	19
		vs Free-air Temperature (LT1037)	20
I_{OS}	Short-circuit output current	vs Time (from short to GND)	28
I_{CC}	Supply current	vs Supply voltage	29
z_o	Closed-loop output impedance	vs Frequency	30
	Pulse response (LT1037)	Small-signal ($C_L = 15$ pF)	31
		Large-signal	32
	Pulse response (LT1007)	Small-signal ($C_L = 15$ pF)	33
		Large-signal	34

LT1007, LT1007A, LT1037, LT1037A LOW-NOISE, HIGH-SPEED, PRECISION OPERATIONAL AMPLIFIERS

SLOS017C – D3195, FEBRUARY 1989 – REVISED JANUARY 1993

TYPICAL CHARACTERISTICS†

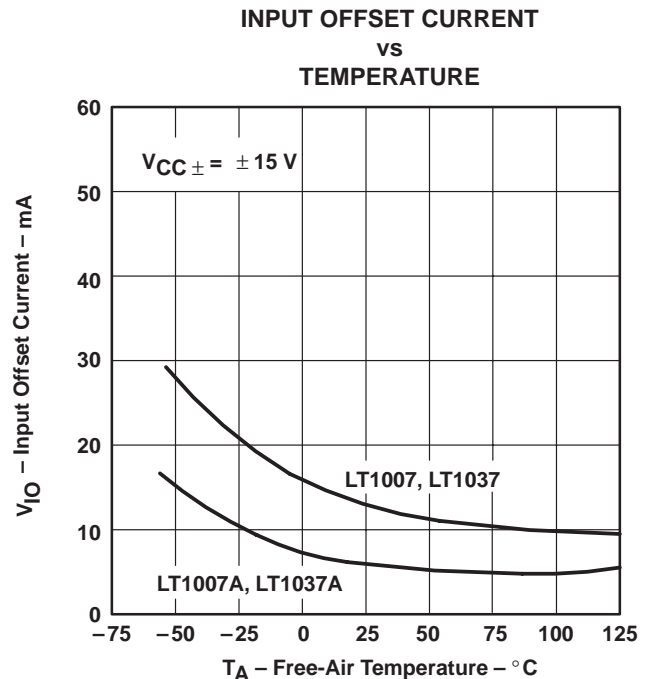
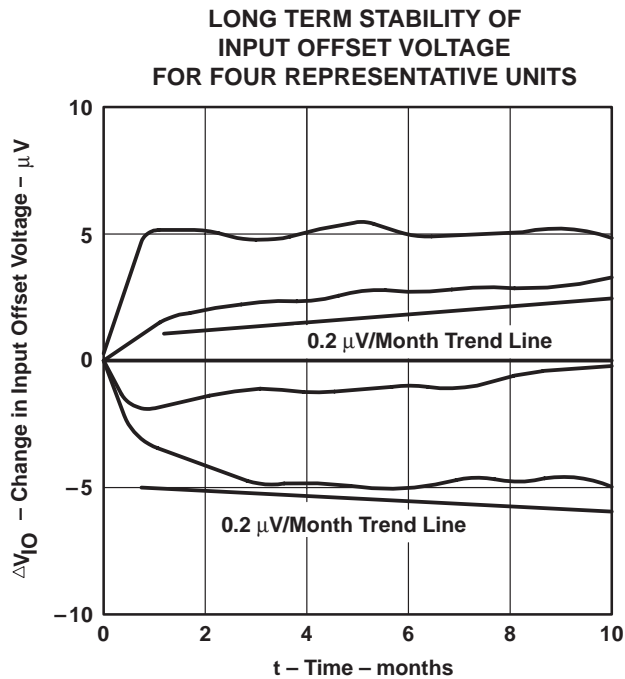
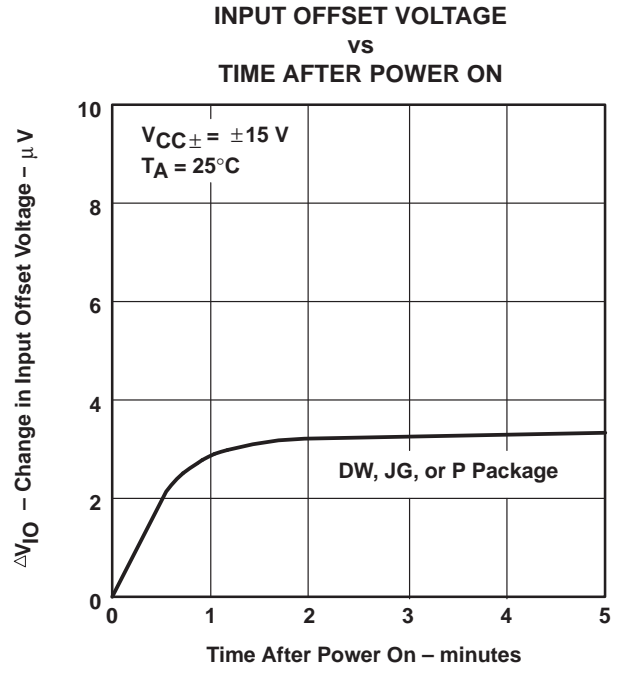
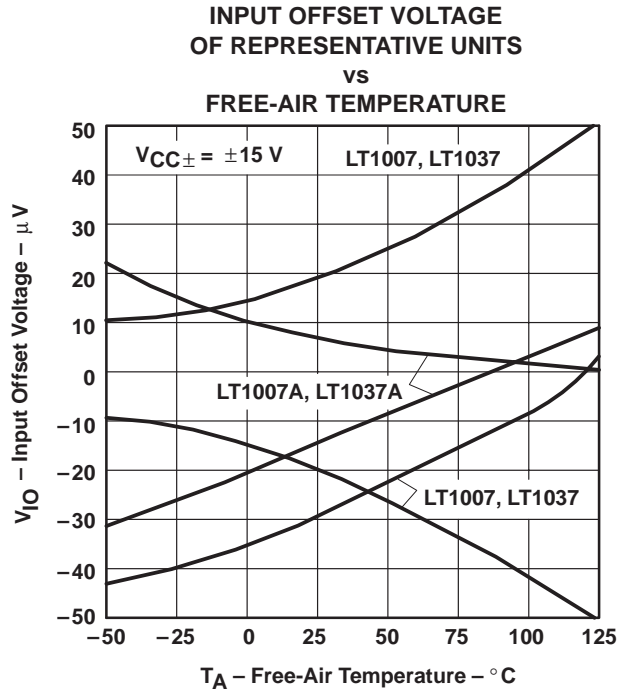

† Data at high and low temperatures are applicable within the rated operating free-air temperature ranges of the various devices.

TYPICAL CHARACTERISTICS†

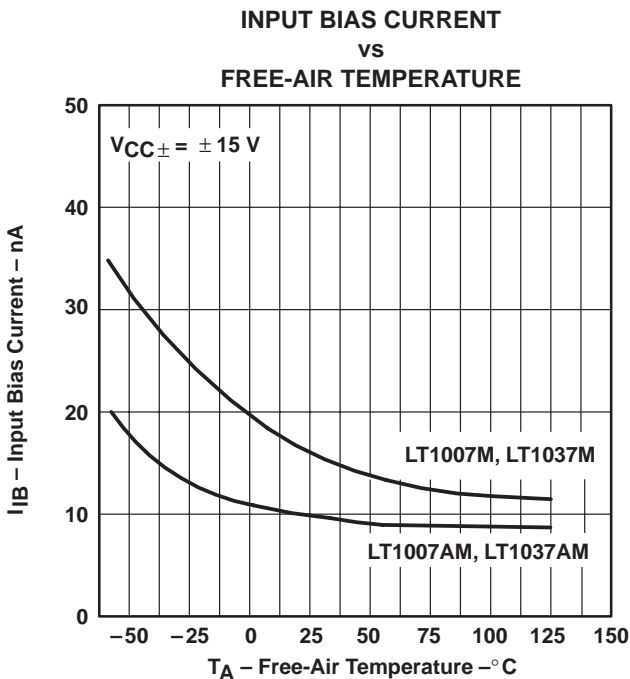

Figure 5

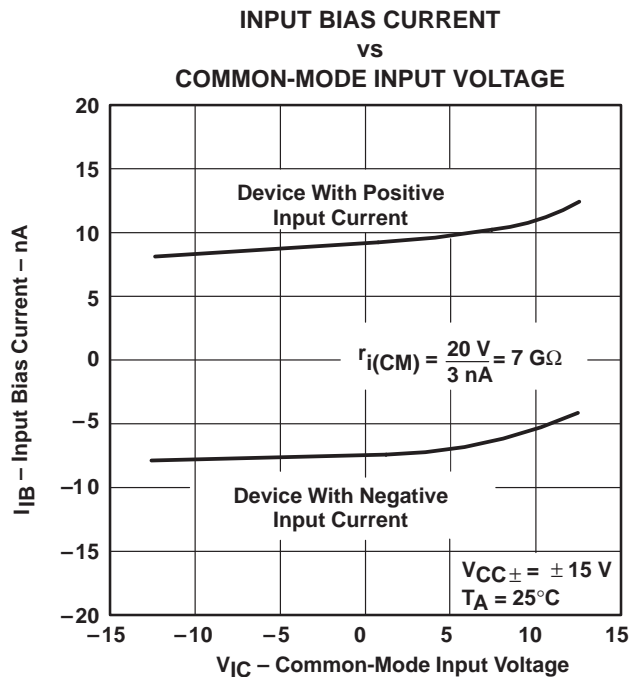

Figure 6

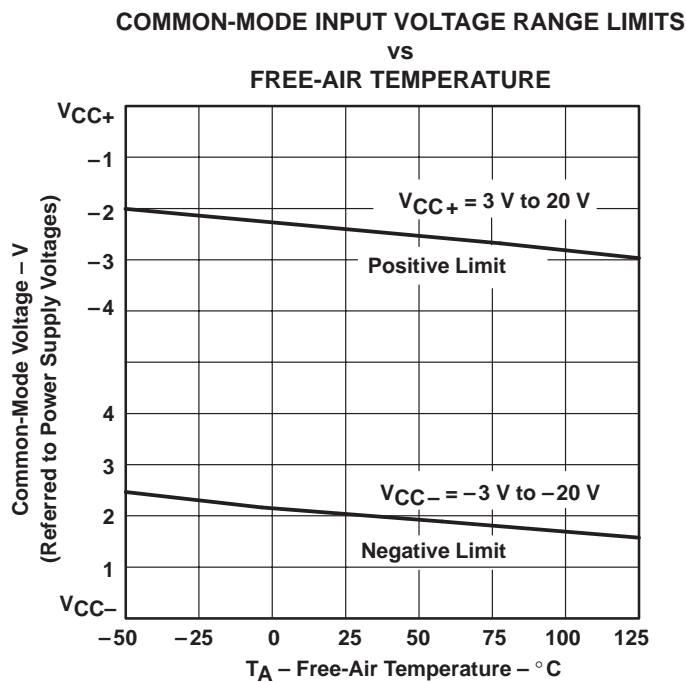

Figure 7

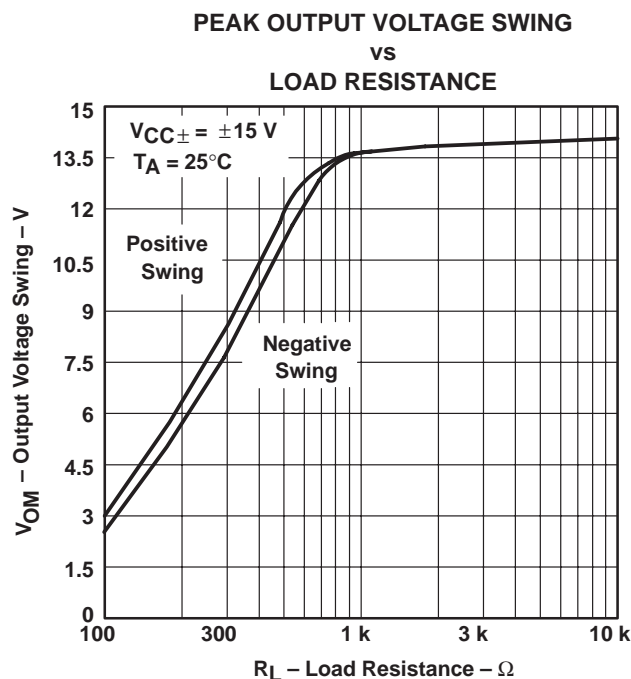

Figure 8

† Data at high and low temperatures are applicable within the rated operating free-air temperature ranges of the various devices.

LT1007, LT1007A, LT1037, LT1037A LOW-NOISE, HIGH-SPEED, PRECISION OPERATIONAL AMPLIFIERS

SLOS017C – D3195, FEBRUARY 1989 – REVISED JANUARY 1993

TYPICAL CHARACTERISTICS

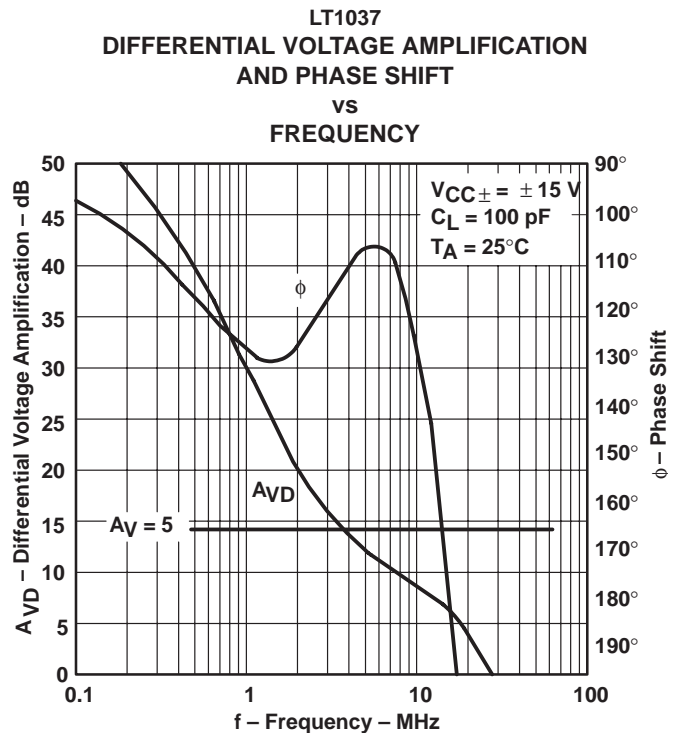
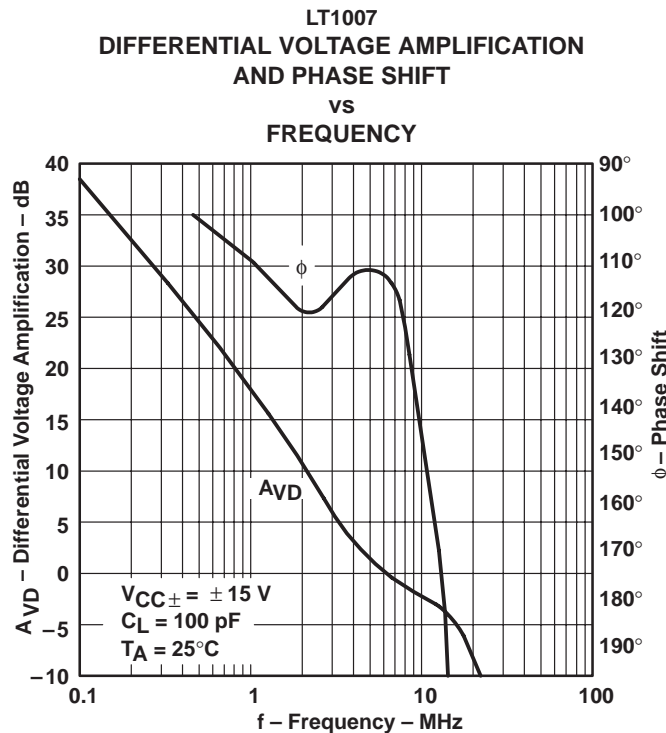
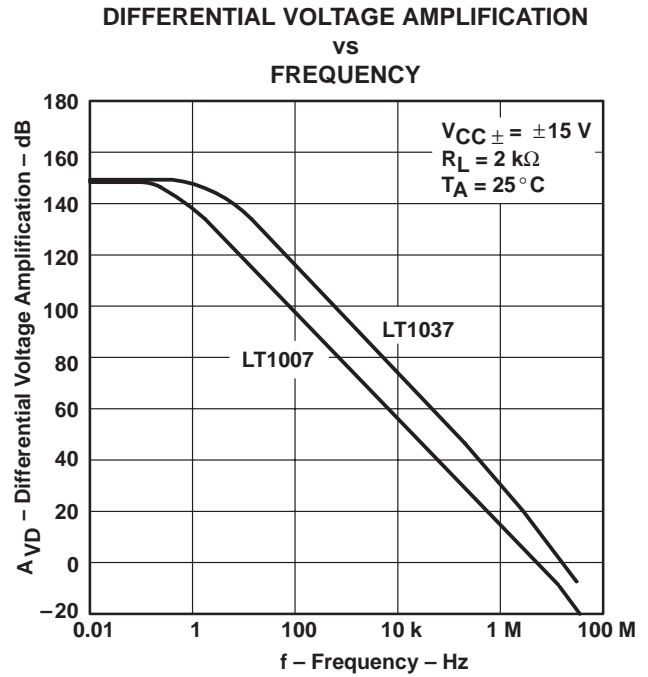
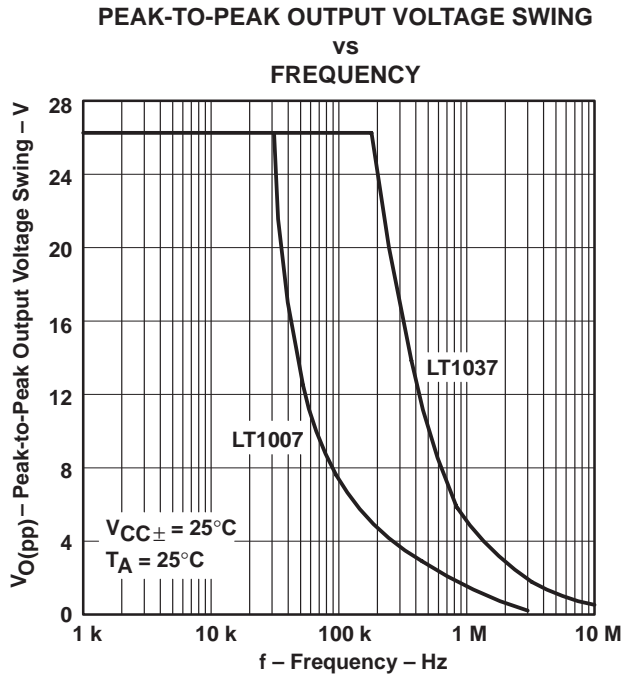

TYPICAL CHARACTERISTICS†

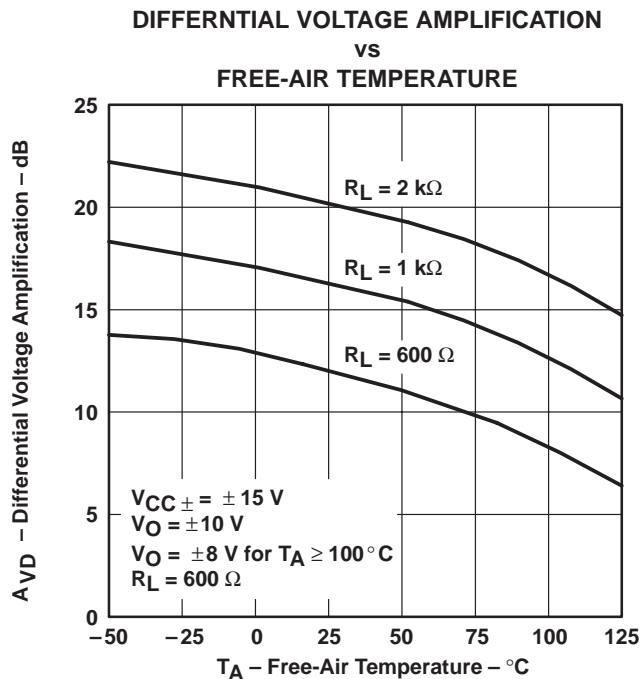

Figure 13

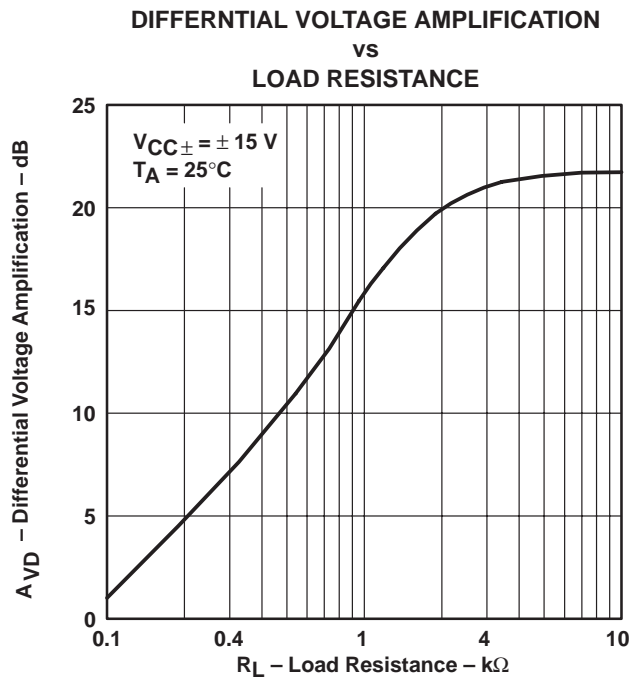

Figure 14

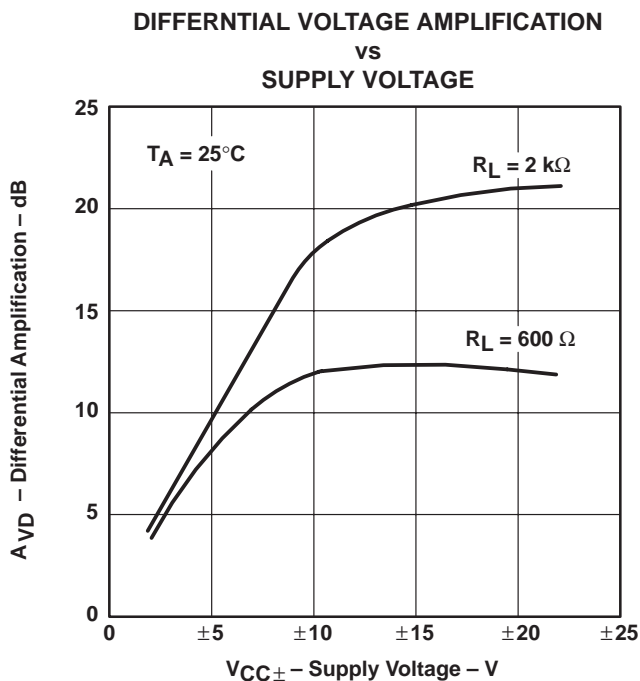

Figure 15

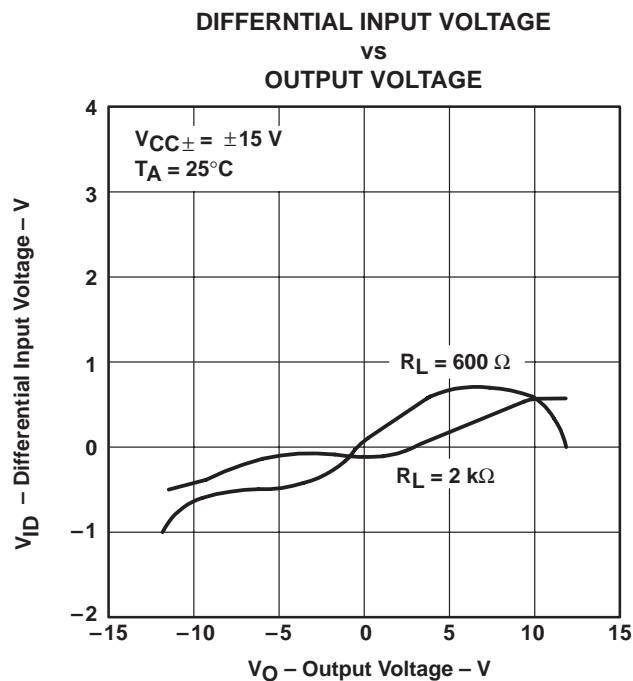

Figure 16

† Data at high and low temperatures are applicable within the rated operating free-air temperature ranges of the various devices.

LT1007, LT1007A, LT1037, LT1037A LOW-NOISE, HIGH-SPEED, PRECISION OPERATIONAL AMPLIFIERS

SLOS017C – D3195, FEBRUARY 1989 – REVISED JANUARY 1993

TYPICAL CHARACTERISTICS†

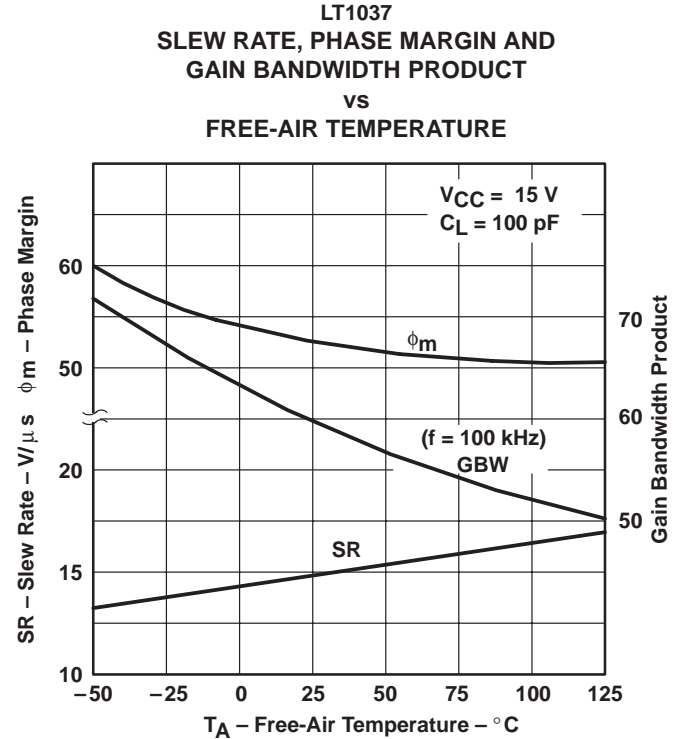
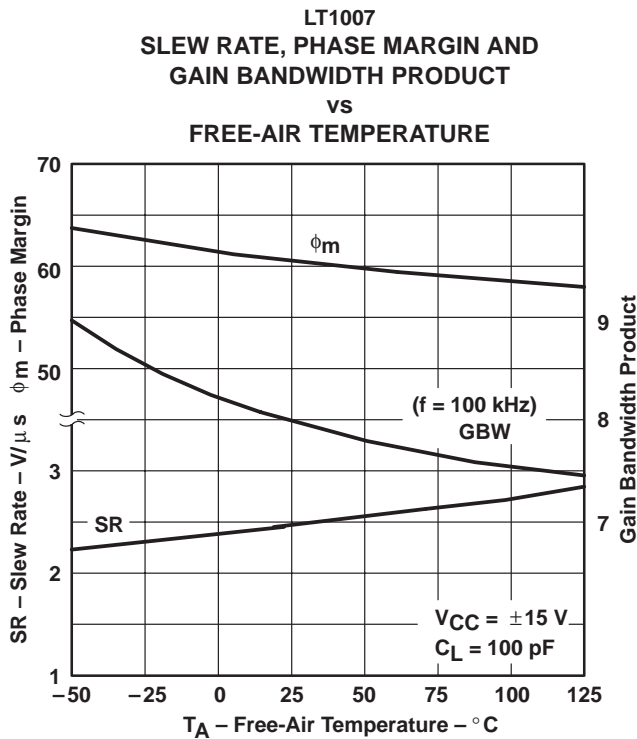
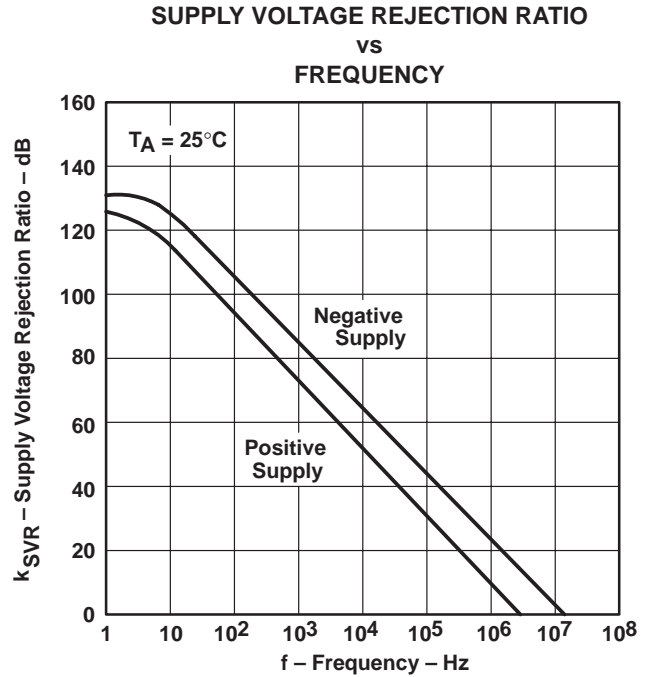
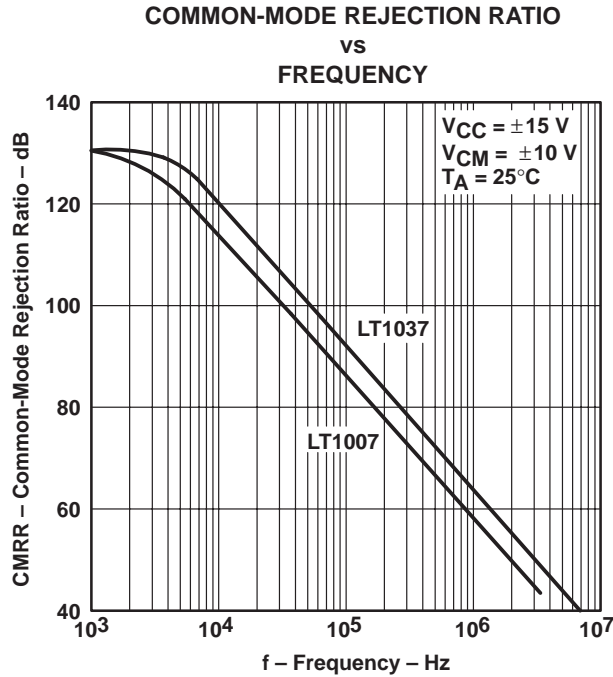

† Data at high and low temperatures are applicable within the rated operating free-air temperature ranges of the various devices.

LT1007, LT1007A, LT1037, LT1037A LOW-NOISE, HIGH-SPEED, PRECISION OPERATIONAL AMPLIFIERS

SLOS017C – D3195, FEBRUARY 1989 – REVISED JANUARY 1993

TYPICAL CHARACTERISTICS†

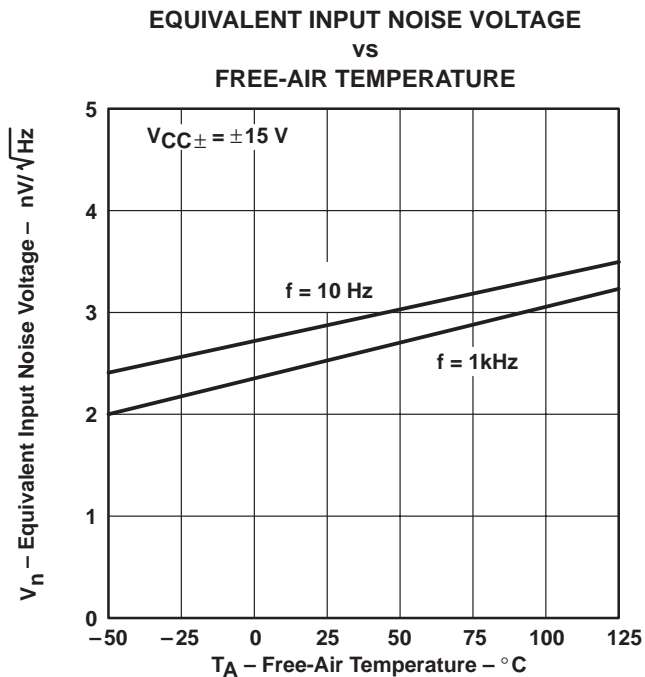

Figure 21

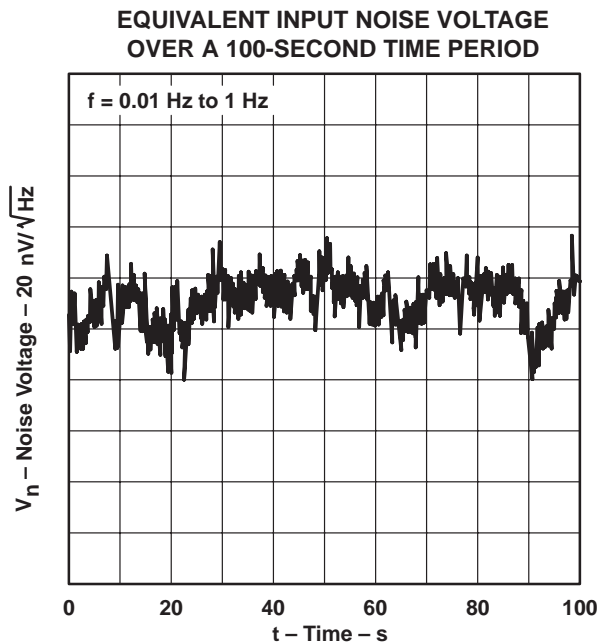

Figure 22

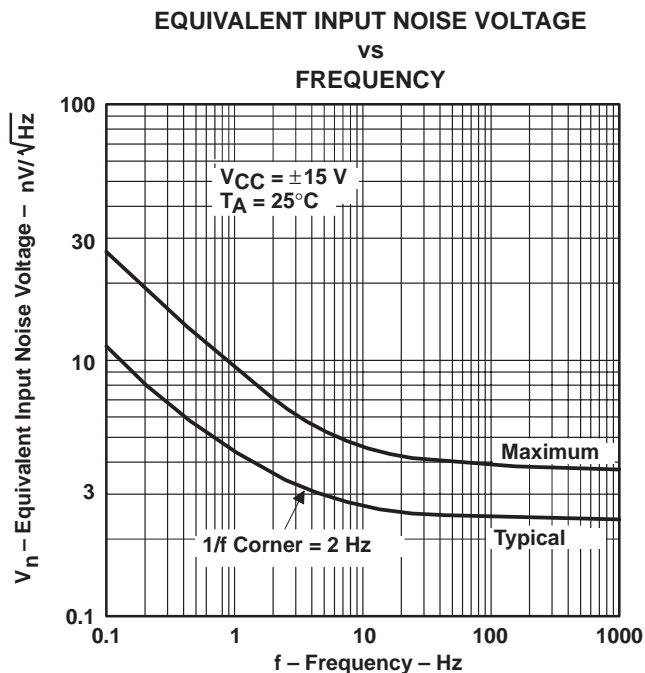

Figure 23

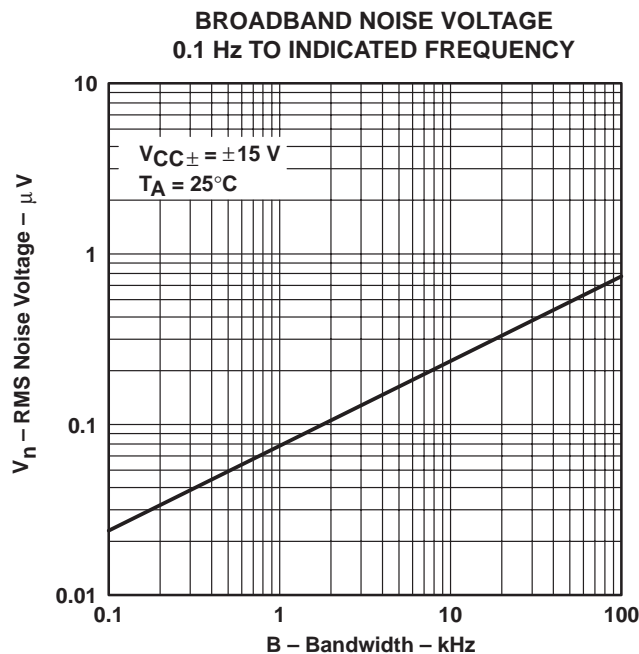

Figure 24

† Data at high and low temperatures are applicable within the rated operating free-air temperature ranges of the various devices.

LT1007, LT1007A, LT1037, LT1037A LOW-NOISE, HIGH-SPEED, PRECISION OPERATIONAL AMPLIFIERS

SLOS017C – D3195, FEBRUARY 1989 – REVISED JANUARY 1993

TYPICAL CHARACTERISTICS†

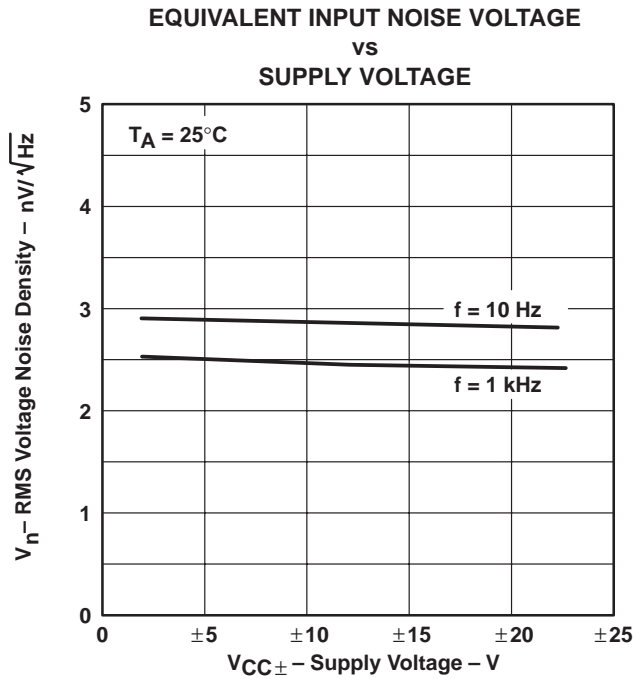

Figure 25

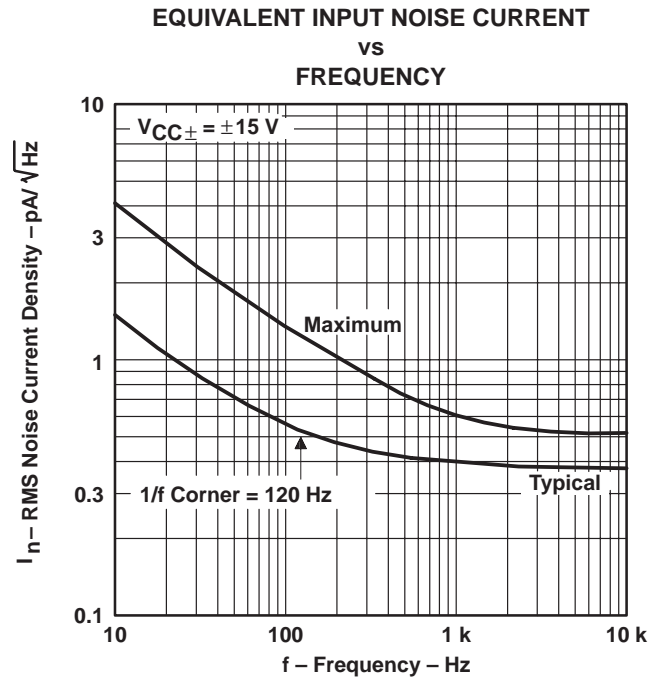

Figure 26

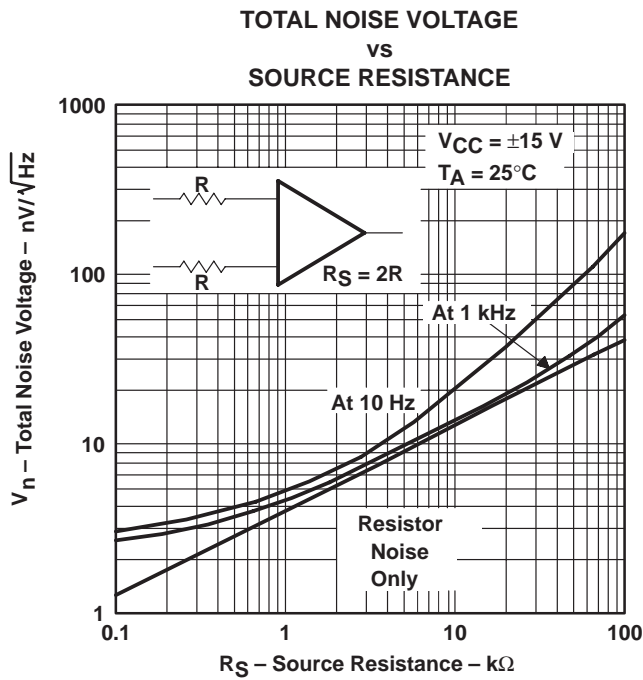

Figure 27

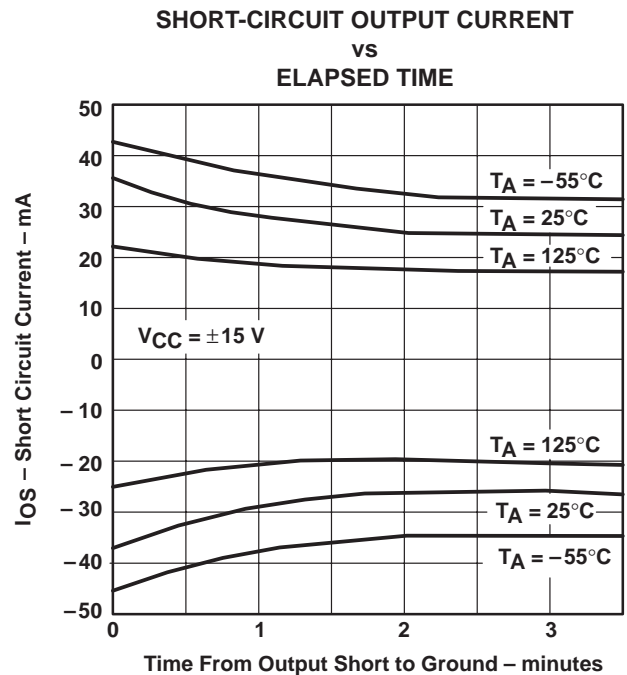

Figure 28

† Data at high and low temperatures are applicable within the rated operating free-air temperature ranges of the various devices.

LT1007, LT1007A, LT1037, LT1037A

LOW-NOISE, HIGH-SPEED, PRECISION OPERATIONAL AMPLIFIERS

SLOS017C – D3195, FEBRUARY 1989 – REVISED JANUARY 1993

TYPICAL CHARACTERISTICS†

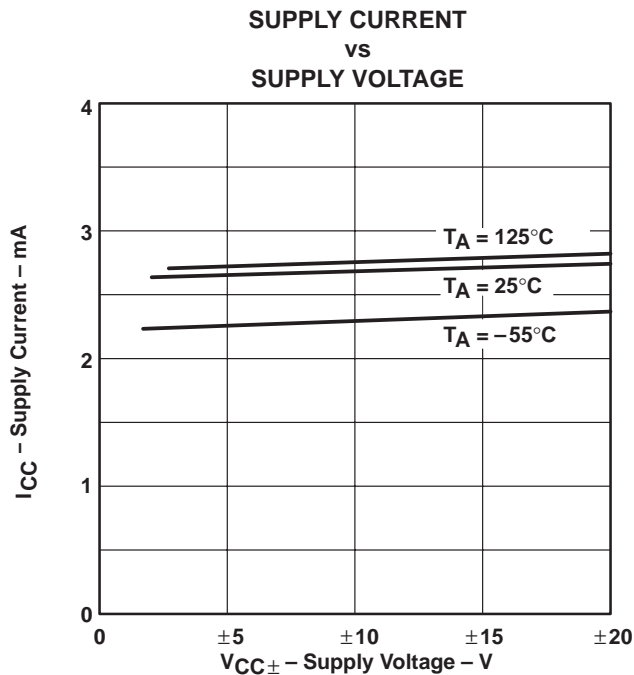

Figure 29

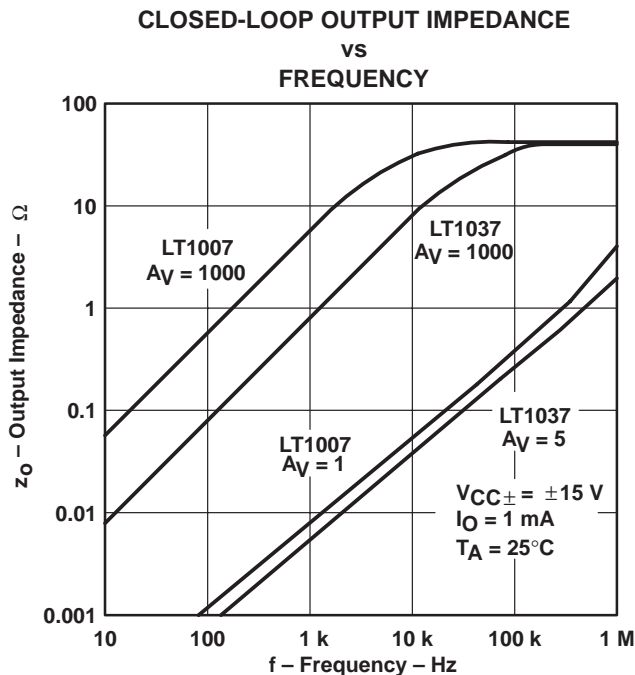

Figure 30

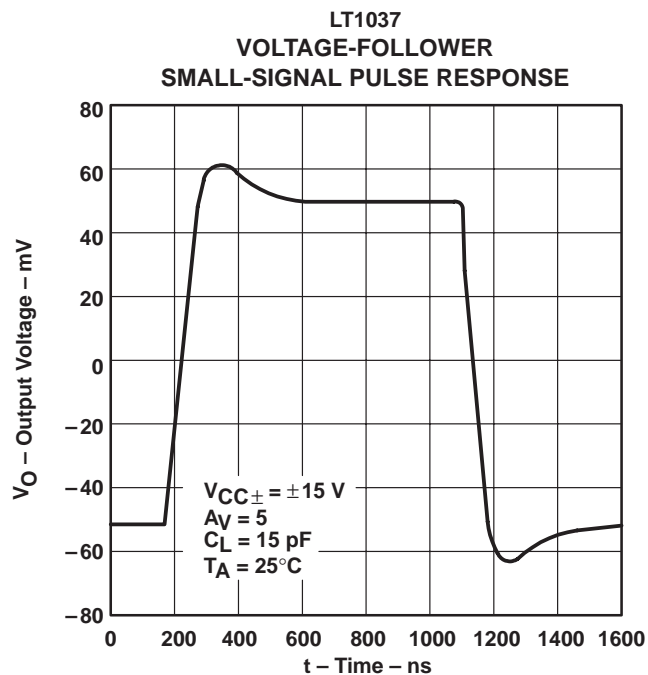

Figure 31

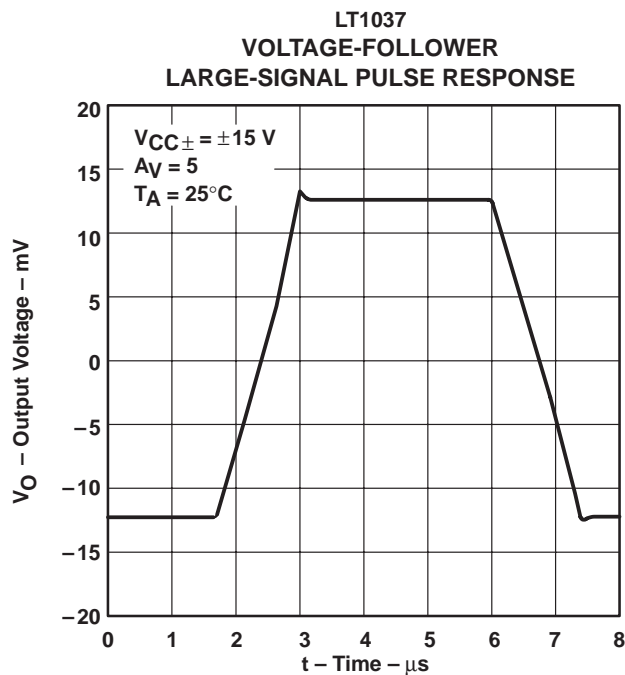

Figure 32

† Data at high and low temperatures are applicable within the rated operating free-air temperature ranges of the various devices.

LT1007, LT1007A, LT1037, LT1037A LOW-NOISE, HIGH-SPEED, PRECISION OPERATIONAL AMPLIFIERS

SLOS017C – D3195, FEBRUARY 1989 – REVISED JANUARY 1993

TYPICAL CHARACTERISTICS

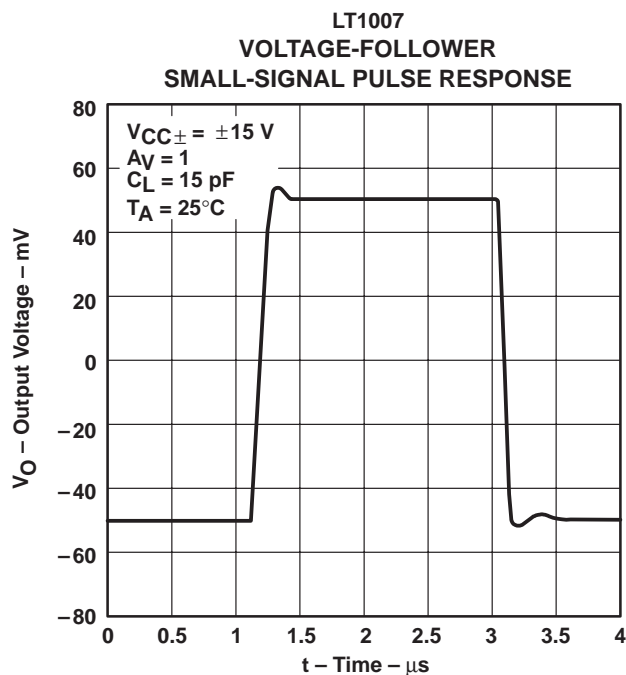

Figure 33

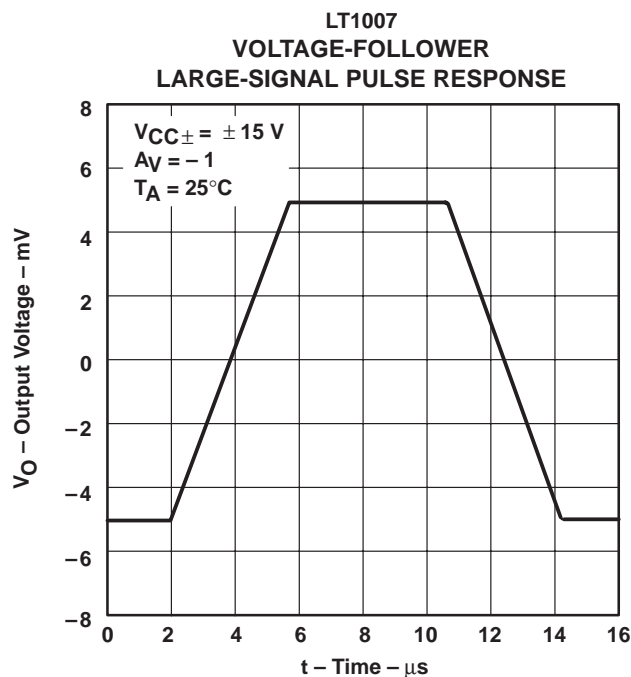

Figure 34

APPLICATION INFORMATION

general

The LT1007- and LT1037-series devices may be inserted directly into OP-07, OP-27, OP-37, and 5534 sockets with or without removal of external-compensation or nulling components. In addition, the LT1007 and LT1037 may be fitted to $\mu\text{A}741$ sockets by removing or modifying external nulling components.

offset voltage adjustment

The input offset voltage and its change with temperature of the LT1007 and LT1037 are permanently trimmed to a low level at wafer testing. However, if further adjustment of V_{IO} is necessary, the use of a 10-k Ω nulling potentiometer, as shown in Figure 35, will not degrade drift with temperature. Trimming to a value other than zero creates a drift of $V_{IO}/300\text{ }\mu\text{V}/^\circ\text{C}$ (e.g., if V_{IO} is adjusted to 300 μV , the change in temperature coefficient will be 1 $\mu\text{V}/^\circ\text{C}$).

The adjustment range with a 10-k Ω potentiometer is approximately $\pm 2.5\text{ mV}$. If a smaller adjustment range is needed, the sensitivity and resolution of the nulling can be improved by using a smaller potentiometer in conjunction with fixed resistors. The example in Figure 36 has an approximate null range of $\pm 200\text{ }\mu\text{V}$.

offset voltage and drift

Unless proper care is exercised, thermocouple effects at the contacts to the input terminals, caused by temperature gradients across dissimilar metals, can exceed the inherent temperature coefficient of the amplifier. Air currents should be minimized, package leads should be short, input leads should be close together, and input leads should be at the same temperature.

APPLICATION INFORMATION

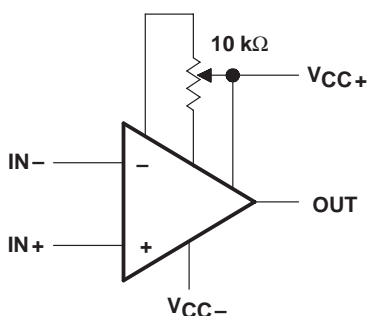

Figure 35. Standard Adjustment

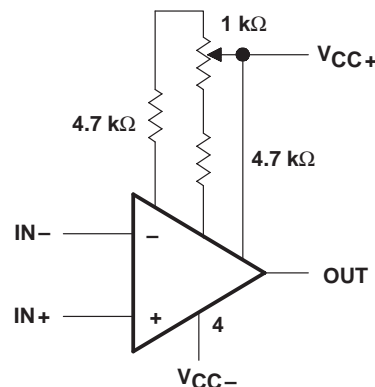

Figure 36. Improved Sensitivity Adjustment

The circuit shown in Figure 37 can be used to measure offset voltage. In addition, with the supply voltages increased to ± 20 V, it can be used as the burn-in configuration for the LT1007 and LT1037.

When $R_F \leq 100 \Omega$ and the input is driven with a fast large-signal pulse (> 1 V), the output waveform will be as shown in Figure 38.

During the fast-feedthrough-like portion of the output, the input protection diodes effectively short the output to the input and a current, limited only by the output short-circuit protection, is drawn by the signal generator. When R_F is $\geq 500 \Omega$, the output is capable of handling the current requirements ($I_L \leq 20$ mA at 10 V), the amplifier stays in its active mode, and a smooth transition occurs.

When R_F is > 2 k Ω , a pole will be created with R_F and the amplifier's input capacitance, creating additional phase shift and reducing the phase margin. A small capacitor (20 pF to 50 pF) in parallel with R_F will eliminate this problem.

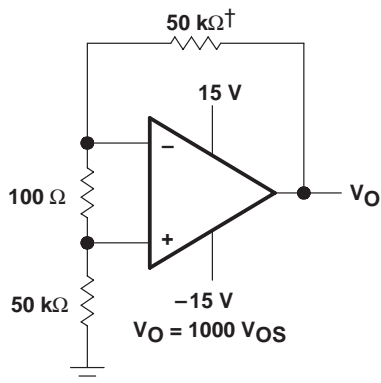

† Resistors must have low thermoelectric potential

Figure 37. Test Circuit for Offset Voltage and Offset Voltage Drift With Temperature

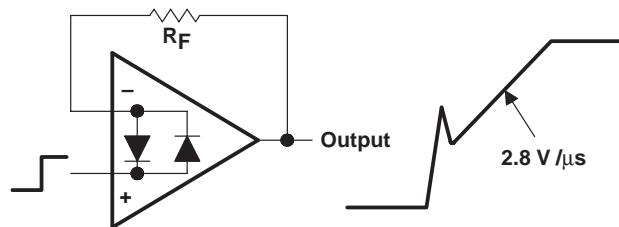

Figure 38. Pulse Operation

LT1007, LT1007A, LT1037, LT1037A LOW-NOISE, HIGH-SPEED, PRECISION OPERATIONAL AMPLIFIERS

SLOS017C – D3195, FEBRUARY 1989 – REVISED JANUARY 1993

APPLICATION INFORMATION

noise testing

Figure 39 shows a test circuit for 0.1-Hz to 10-Hz peak-to-peak noise measurement of the LT1007 and LT1037. The frequency response of this noise tester indicates that the 0.1 Hz corner is defined by only one zero. Because the time limit acts as an additional zero to eliminate noise contributions from the frequency band below 0.1 Hz, the test time to measure 0.1-Hz to 10-Hz noise should not exceed 10 seconds.

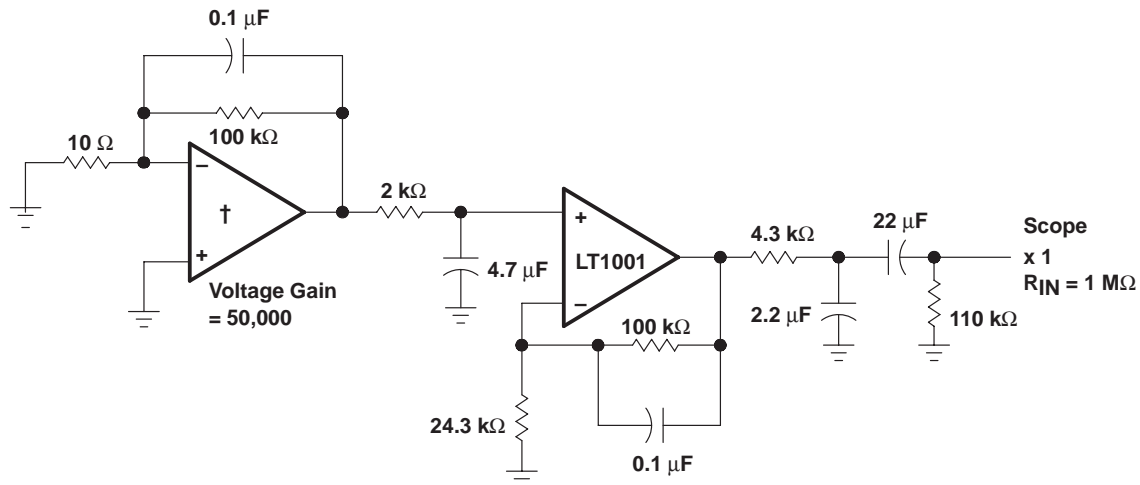
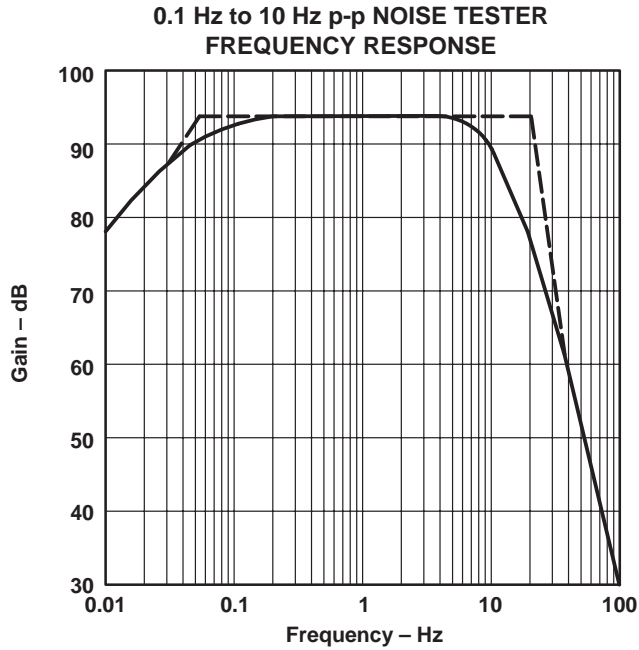

† Device under test

NOTE: All capacitor values are for non-polarized capacitors only.

Figure 39. 0.1-Hz To 10-Hz Noise Test Circuit

APPLICATION INFORMATION

Special test precautions are required to measure the typical 60-nV peak-to-peak noise performance of the LT1007 and LT1037:

1. The device should be warmed up for at least five minutes. As the operational amplifier warms up, the offset voltage typically changes 3 μ V, due to the chip temperature increasing 10°C to 20°C from the moment the power supplies are turned on. In the 10-second measurement interval, these temperature-induced effects can easily exceed tens of nanovolts.
2. The device must be well shielded from air currents to eliminate thermoelectric effects. In excess of a few nanovolts, thermoelectric effects would invalidate the measurements.
3. Sudden motion in the vicinity of the device can produce a feedthrough effect that increases observed noise.

When measuring noise on a large number of units, a noise-voltage density test is recommended. A 10-Hz noise-voltage density measurement will correlate well with a 0.1-Hz to 10-Hz peak-to-peak noise reading since both results are determined by the white noise and the location of the 1/f corner frequency.

Figure 40 shows a circuit that measures noise current and presents the formula for calculating noise current.

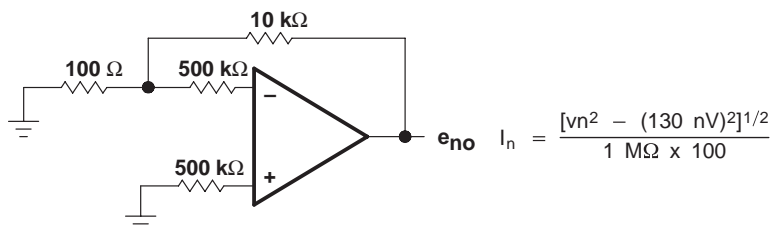

Figure 40. Noise Test Circuit

The LT1007 and LT1037 achieve low noise, in part, by operating the input stage at 120 μ A versus the typical 10 μ A for most other operational amplifiers. Voltage noise is directly proportional to the square root of the stage current; therefore, the LT1007 and LT1037 noise current is relatively high. At low frequencies, the low 1/f current-noise corner frequency (\approx 120 Hz) minimizes noise current to some extent.

In most practical applications, however, noise current will not limit system performance; this is illustrated in Figure 27, where:

$$\text{total noise} = [(\text{noise voltage})^2 + (\text{noise current} \times R_S)^2 + (\text{resistor noise})^2]^{1/2}$$

Three regions can be identified as a function of source resistance:

- | | |
|---|---|
| (i) $R_S \leq 400 \Omega$ | Voltage noise dominates in region (i) |
| (ii) $R_S = 400 \Omega$ to 50 k Ω at 1 kHz
$R_S = 400 \Omega$ to 8 k Ω at 10 kHz | Resistor noise dominates in region (ii) |
| (iii) $R_S > 50 \Omega$ at 1 kHz
$R_S > 8 \text{ k}\Omega$ at 10 Hz | Current noise dominates in region (iii) |

The LT1007 and LT1037 should not be used in region (iii) where total system noise is at least six times higher than the noise voltage of the operational amplifier (i.e., the low-voltage noise specification is completely wasted).

LT1007, LT1007A, LT1037, LT1037A LOW-NOISE, HIGH-SPEED, PRECISION OPERATIONAL AMPLIFIERS

SLOS017C – D3195, FEBRUARY 1989 – REVISED JANUARY 1993

APPLICATION INFORMATION

The sine wave generator application shown below, utilizes the low-noise and low-distortion characteristics of the LT1037.

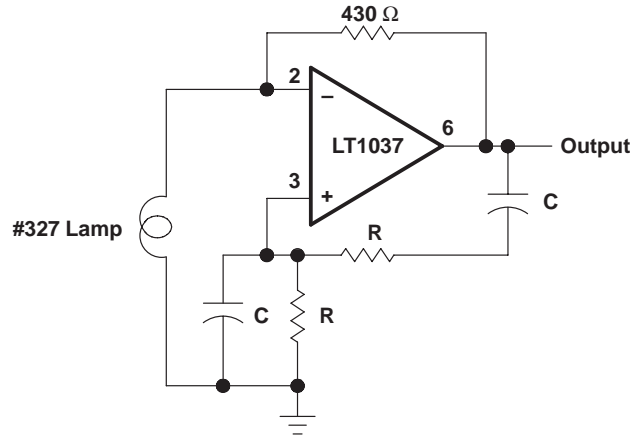

$$f = \frac{1}{2\pi RC}$$

$$R = 1591.5\Omega \pm 0.1\%$$

$$C = 0.1 \mu\text{F} \pm 0.1\%$$

TOTAL HARMONIC DISTORTION $\leq 0.0025\%$
 NOISE $\leq 0.001\%$
 AMPLITUDE = $\pm 8 \text{ V}$
 OUTPUT FREQUENCY = 1.000 kHz FOR VALUES GIVEN $\pm 0.4\%$

Figure 41. Ultra-Pure 1-kHz Sine-Wave Generator

EQUIVALENT INPUT NOISE VOLTAGE OVER A 10-SECOND PERIOD

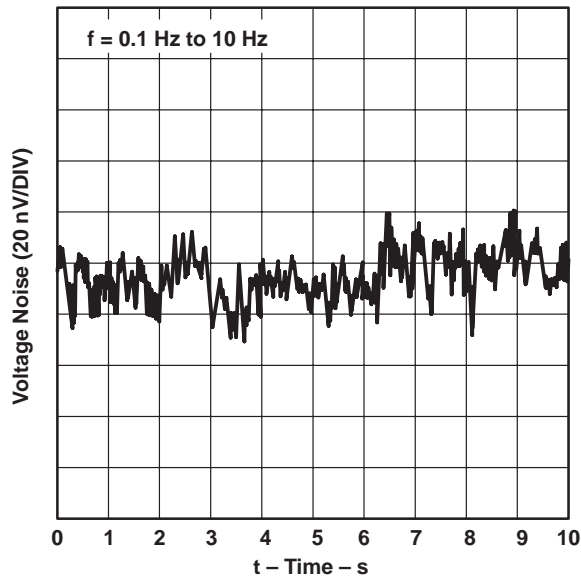
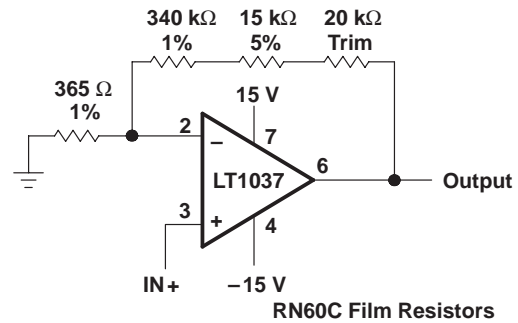

Figure 42



RN60C Film Resistors

The high gain and wide bandwidth of the LT1037 and (LT1007) is useful in low-frequency high-closed-loop-gain amplifier applications. A typical precision operational amplifier may have an open loop gain of one million with 500 kHz bandwidth. As the gain error plot shows, this device is capable of 0.1% amplifying accuracy up to 0.3 Hz only. Even instrumentation range signals can vary at a faster rate. The LT1037's gain precision – bandwidth product is 200 times higher, as shown.

Figure 43. Gain 1000 Amplifier With
0.01% Accuracy, DC to 5 Hz

APPLICATION INFORMATION

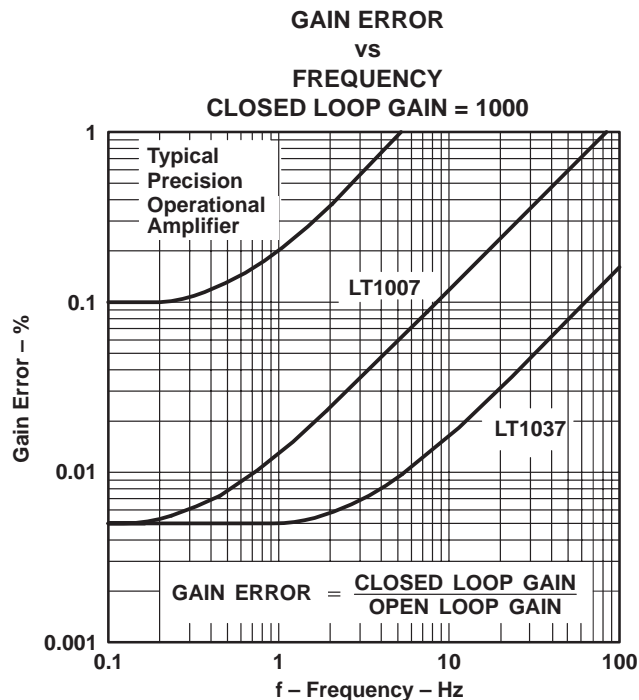
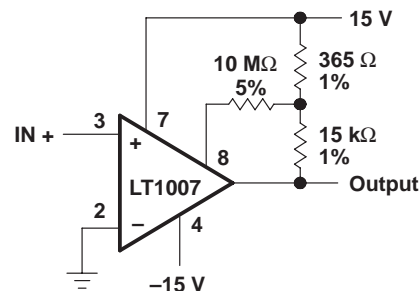

Figure 44.



Positive feedback to one of the nulling terminals creates approximately 5 μV of hysteresis. Output can sink 16 mA.

Input offset voltage is typically changed less than 5 μV due to the feedback.

Figure 45. Microvolt Comparator With Hysteresis

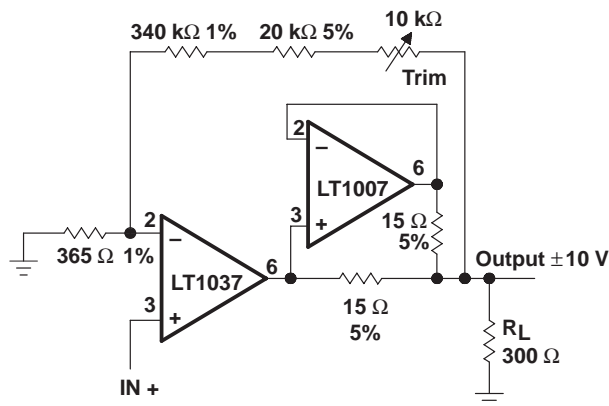

The addition of the LT1007 doubles the amplifier's output drive to ±33 mA. Gain accuracy is 0.02%, slightly degraded compared to above because of self heating of the LT1037 under load.

Figure 46. Precision Amplifier Drives 300-Ω Load to ±10 V

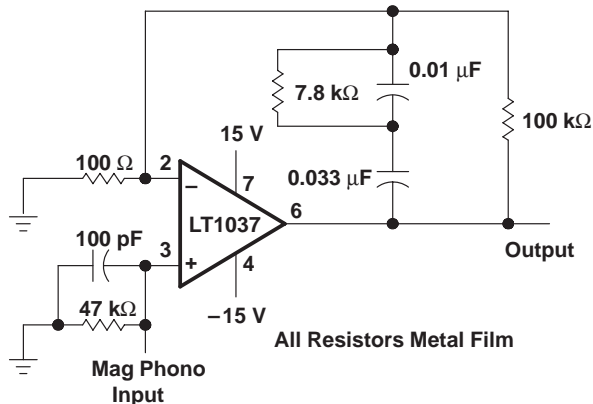

Figure 47. Phono Preamplifier

LT1007, LT1007A, LT1037, LT1037A LOW-NOISE, HIGH-SPEED, PRECISION OPERATIONAL AMPLIFIERS

SLOS017C – D3195, FEBRUARY 1989 – REVISED JANUARY 1993

APPLICATION INFORMATION

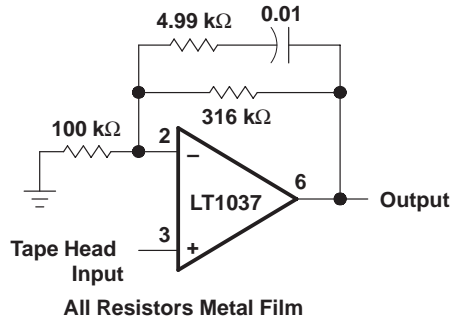

Figure 48. Tape Head Amplifier

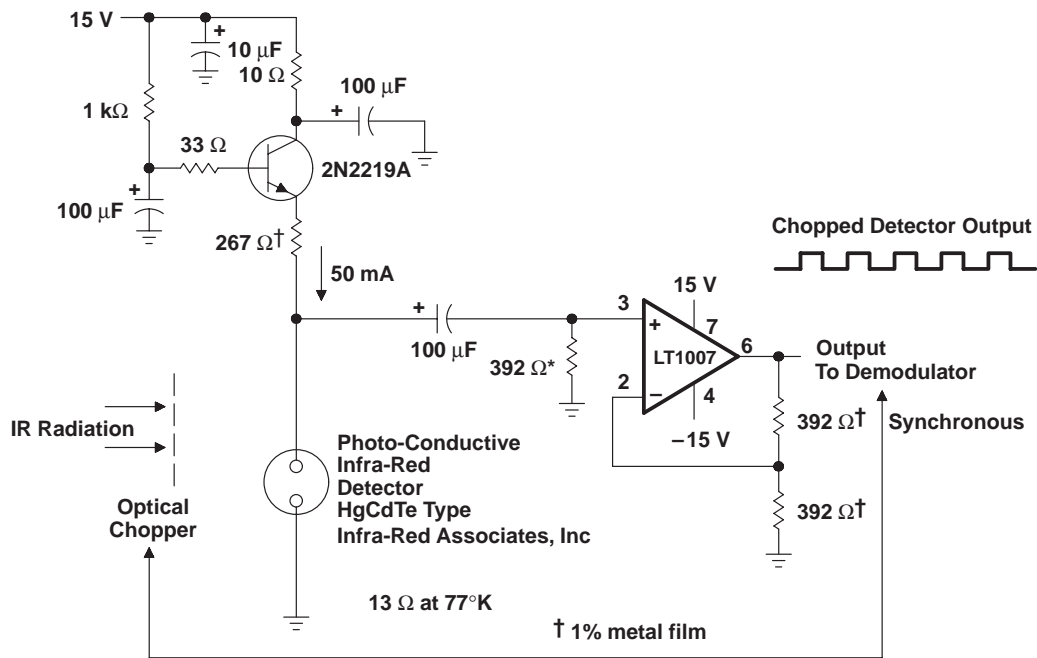
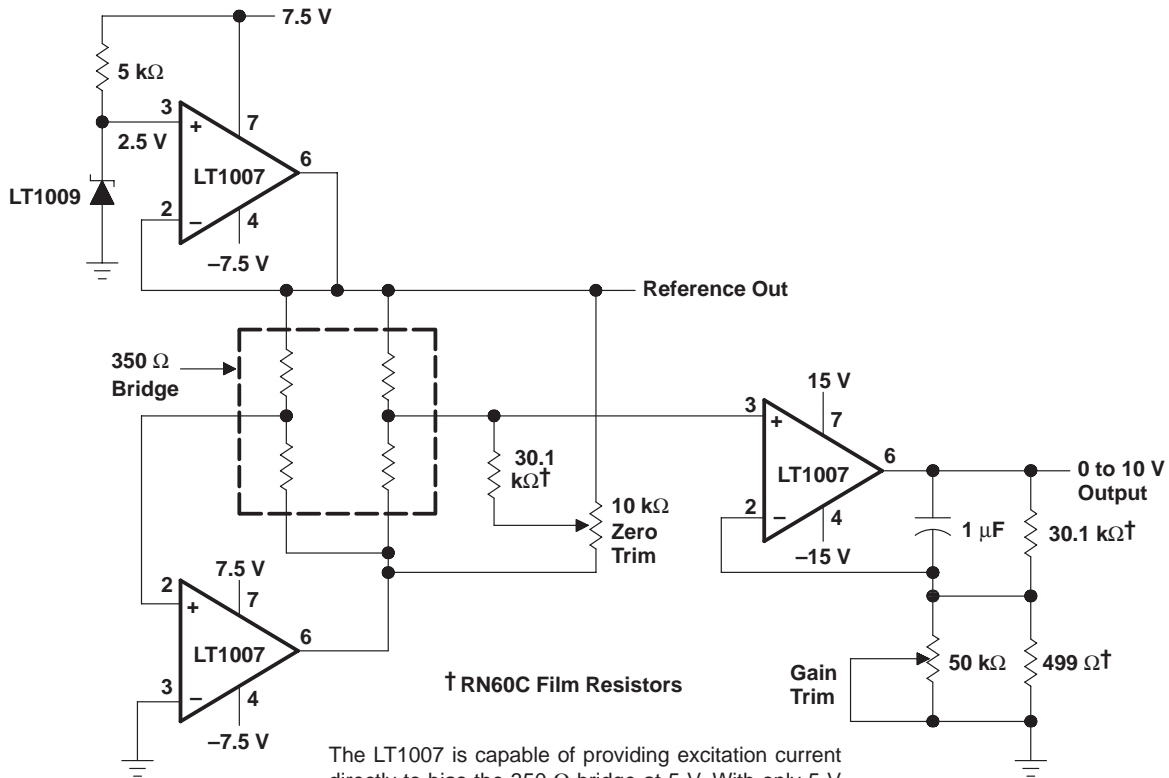

Figure 49. Infra-Red Detector Preamplifier

APPLICATION INFORMATION



The LT1007 is capable of providing excitation current directly to bias the 350- Ω bridge at 5 V. With only 5 V across the bridge (as opposed to the usual 10 V) total power dissipation and bridge warm-up drift is reduced. The bridge output signal is halved, but the LT1007 can amplify the reduced signal accurately.

Figure 50. Strain Gauge Signal Conditioner With Bridge Excitation

IMPORTANT NOTICE

Texas Instruments and its subsidiaries (TI) reserve the right to make changes to their products or to discontinue any product or service without notice, and advise customers to obtain the latest version of relevant information to verify, before placing orders, that information being relied on is current and complete. All products are sold subject to the terms and conditions of sale supplied at the time of order acknowledgement, including those pertaining to warranty, patent infringement, and limitation of liability.

TI warrants performance of its semiconductor products to the specifications applicable at the time of sale in accordance with TI's standard warranty. Testing and other quality control techniques are utilized to the extent TI deems necessary to support this warranty. Specific testing of all parameters of each device is not necessarily performed, except those mandated by government requirements.

CERTAIN APPLICATIONS USING SEMICONDUCTOR PRODUCTS MAY INVOLVE POTENTIAL RISKS OF DEATH, PERSONAL INJURY, OR SEVERE PROPERTY OR ENVIRONMENTAL DAMAGE ("CRITICAL APPLICATIONS"). TI SEMICONDUCTOR PRODUCTS ARE NOT DESIGNED, AUTHORIZED, OR WARRANTED TO BE SUITABLE FOR USE IN LIFE-SUPPORT DEVICES OR SYSTEMS OR OTHER CRITICAL APPLICATIONS. INCLUSION OF TI PRODUCTS IN SUCH APPLICATIONS IS UNDERSTOOD TO BE FULLY AT THE CUSTOMER'S RISK.

In order to minimize risks associated with the customer's applications, adequate design and operating safeguards must be provided by the customer to minimize inherent or procedural hazards.

TI assumes no liability for applications assistance or customer product design. TI does not warrant or represent that any license, either express or implied, is granted under any patent right, copyright, mask work right, or other intellectual property right of TI covering or relating to any combination, machine, or process in which such semiconductor products or services might be or are used. TI's publication of information regarding any third party's products or services does not constitute TI's approval, warranty or endorsement thereof.