



**SAMSUNG**

**SEMICONDUCTOR**

# **LT104V3-102 Specifications**

April 1995, Rev. 1

*Preliminary*

[www.DataSheet.in](http://www.DataSheet.in)

# CONTENTS

---

	<u>PAGE</u>
Record of Revision	3
General Description	4
1.    Absolute Maximum Rating	5
1-1 Environmental Absolute Ratings	
1-2 Electrical Absolute Ratings	
2.    Optical Characteristics	6
3.    Electrical Characteristics	8
4.    Block Diagram	9
5.    Input Terminal Pin Assignment	10
6.    Interface Timing	11
6-1 Timing Parameters	
6-2 Timing Diagrams of Interface Sequence	
6-3 Input Signals, Basic Display Colors and Gray Scale of Each Color	
6-4 Power ON/OFF Sequence	
7.    Dimensional Outline	18
8.    Reliability Test	19
9.    Packing, Transportation and Delivery	20
10.   Markings	21
11.   Product Inspection	22
12.   Handling Precaution	23

## RECORD OF REVISION

Date	Sheet No.	Summary	Note
1995.04.28	5/23 (1-2-1)	Power supply voltage change of TFT LCD module -0.5V ---> 4.75V, 6.5V ---> 5.25V	
	5/23 (1-2-2)	Lamp current of backlight unit 3.6mA ---> 3.5mA	
	7/23 Note(7)	Test condition of note(7) : 3.6mA ---> 3.5mA	
	9/23 (3-1-2)	Lamp current of backlight unit: 3.6mA ---> 3.5mA	
	13,14,15/23	Note 4) for max. startup time is added. Measuring time of setup and hold changed from 0.7Vdd(0.2Vdd) to 50% of voltage level.	
	16/23 (6.6-3)	Insert the table for input signals, basic colors and gray scale of each color	
17/23	Item (3) condition of reliability test changed from 90% to 95% humidity.		

## GENERAL DESCRIPTION

### DESCRIPTION

LT104V3- 10S is the color active matrix TFT (Thin Film Transistor) liquid crystal display (LCD) using amorphous silicon TFT's as switching devices. It is composed of a TFT LCD panel, driver circuit and backlight system. The 10.4 inches diagonal display area contains 640 x 480 pixels and can display 262,144 colors. Optimum viewing direction is 6 o'clock. 400 line and 350 line mode in addition to the 480 line mode can be also applied for this module

### FEATURES

- Thin and light weight
- High contrast ratio, wide viewing angle, wide color gamut
- High-speed response
- VGA (640x480 pixels)
- Low power consumption
- Single CCFL
- DE(Data Enable) only function.

### APPLICATIONS

- A4 size notebook computer
- Display terminals for NC machine
- Control board for NC machine
- Monitors for process controller

### General Specifications

ITEM	SPECIFICATION	UNIT
Display area	211.2(H) x 158.4(V) (diagonal size 10.4 ")	mm
Drive	a-Si TFT active matrix	
Display colors	262,144 colors	
Number of pixels	640 x 480	pixel
Pixel arrangement	RGB vertical stripe	
Pixel pitch	0.33(H) x 0.33(W)	mm
Module Size	264(W) x 180(H) x 9.3(D)	mm
Weight	500 (Typ.)	g

# 1. ABSOLUTE MAXIMUM RATINGS

## 1.1 ENVIRONMENTAL ABSOLUTE RATINGS

ITEM	OPERATING		STORAGE		UNIT	NOTE
	MIN.	MAX.	MIN.	MAX.		
Ambient Temp.	0	50	-25	50	°C	
Humidity	-	-	-	90	%RH	
Vibration	-	-	-	14.7(1.5G)	m/s <sup>2</sup>	
Shock	-	-	-	980(100G)		
Corrosive Gas	NOT ACCEPTABLE		NOT ACCEPTABLE		-	

## 1.2 ELECTRICAL ABSOLUTE RATINGS

### (1) TFT LCD MODULE

ITEM	SYMBOL	MIN.	MAX.	UNIT	NOTE
Power Supply Voltage	V <sub>DD</sub>	4.75	5.25	V	T <sub>a</sub> = 25 °C
Input Voltage	V <sub>IN</sub>	-0.3	V <sub>DD</sub> + 0.3	V	
Electro-static Durability	V <sub>TER</sub>	-	± 200	V	(1),(2)
	V <sub>CHA</sub>	-	± 5	kV	(1),(3)

Note (1) 200 pF, 0 Ω, 25 °C, 50%RH

(2) Interface connector pins are subjected

(3) The surface of chassis and LCD panel are subjected

### (2) BACK-LIGHT UNIT

ITEM	SYMBOL	MIN.	TYP.	MAX.	UNIT	NOTE
Lamp Current	I <sub>L</sub>	2.0	3.5	6.0	mA	(1)
Lamp Voltage	V <sub>L</sub>	-	510	-	V <sub>rms</sub>	

Note (1) CCFT lamp be stable in this current range

## 2. OPTICAL CHARACTERISTICS

The following items are measured when the conditions of this unit and measuring systems are stable. The ambient light excluding back-light is nothing.

Measuring equipment : TOPCON BM-7

ITEM	SYMBOL	CONDITION	MIN	TYP	MAX	UNIT	NOTE
Contrast Ratio	CR	Optimal Viewing Angle	100:1	-	-		(1),(2),(7)
Response Time	Rise	$T_r$	-	20	-	msec	(3),(7)
	Fall	$T_f$		40			
Color Chromaticity (CIE)	White	$W_x$	$\phi = 0$ $\theta = 0$ $T_a = 25^\circ\text{C}$	0.2943	0.3143	0.3343	(1)
		$W_y$		0.3069	0.3267	0.3467	
	Red	$R_x$		0.5863	0.6063	0.6263	
		$R_y$		0.3139	0.3339	0.3539	
	Green	$G_x$		0.2755	0.2955	0.3155	
		$G_y$		0.5478	0.5678	0.5878	
	Blue	$B_x$		0.1256	0.1456	0.1656	
		$B_y$		0.1095	0.1295	0.1495	
Viewing Angle	Hor.	$\theta_L$	CR > 10	45	48	50	degrees
		$\theta_R$		45	48	50	
	Ver.	$\phi_H$		10	15	20	
		$\phi_L$		30	35	40	
Luminance			60	70		cd/m <sup>2</sup>	(4),(7)
White Uniformity			-	-	1.25		(5),(7)
Cross Modulation			-	-	1:1.05	%	(6)
Maximum Dark Luminosity			-	-	1	cd/m <sup>2</sup>	(7)

Note (1) Definition of Viewing Angle

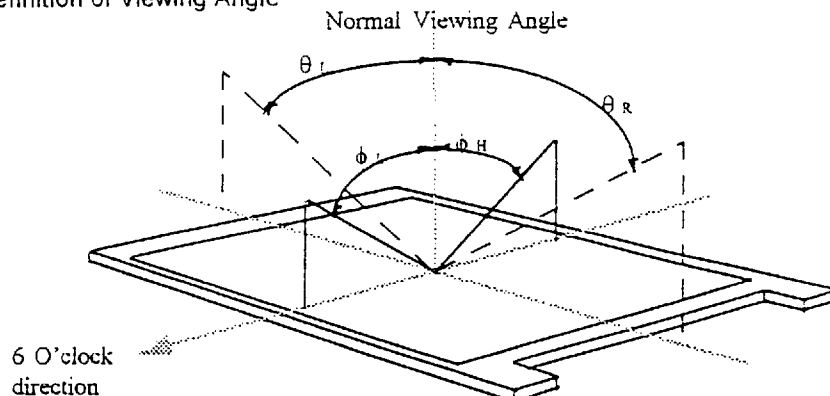

Note (2) Definition of Contrast Ratio(CR)

$$CR = \frac{\text{Luminance(Brightness) of white}}{\text{Luminance(Brightness) of Black}}$$

Note (3) Definition of Response time

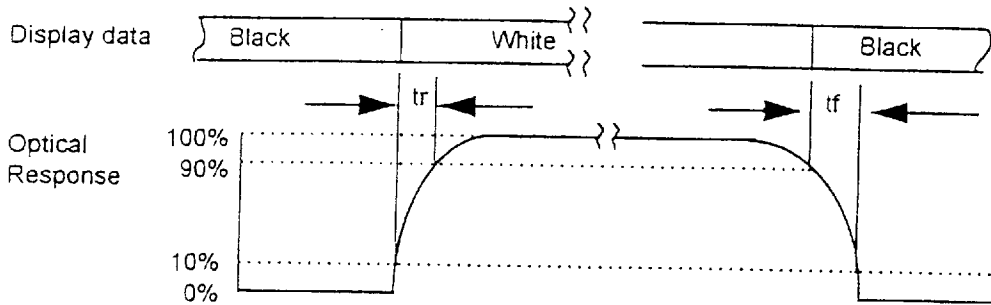

Note (4) Definition of Luminance : This luminance provided at 3.5mA of CCFT lamp current

Note (5) Definition of Uniformity : check the white luminance variation at 5 test points

$$\text{Uniformity} = \frac{\text{MAX luminance}}{\text{MIN luminance}}$$

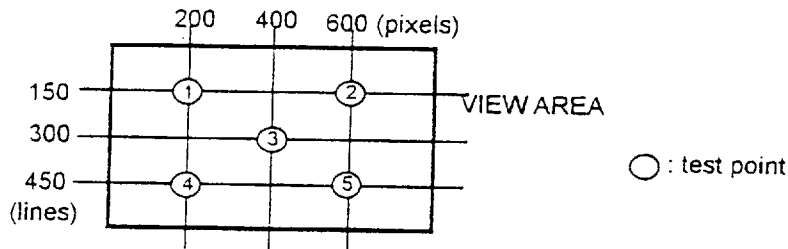

Note (6) Definition of Cross Modulation

$$\text{Cross Modulation Ratio} = \frac{|Y_B - Y_A|}{Y_B} \times 100 (\%)$$

Where:

$Y_A$  = Luminance of measured location without darkest gray pattern (  $\text{cd/m}^2$  )

$Y_B$  = Luminance of measured location with darkest gray pattern (  $\text{cd/m}^2$  )

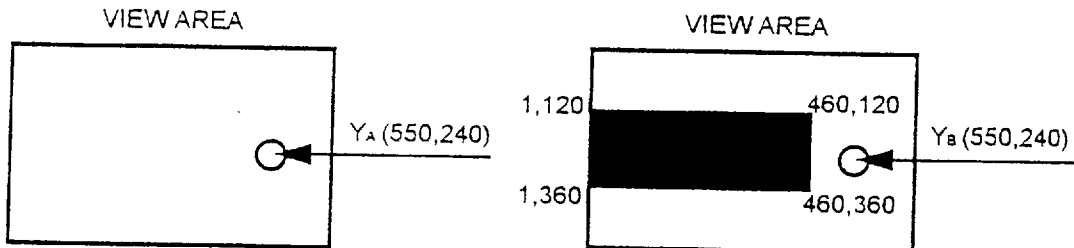

Note (7) Test condition

- At least 20 minutes after CCFT turn on and being run at 40KHz and a 3.5mA current

### 3. ELECTRICAL CHARACTERISTICS

#### (1) TFT LCD MODULE

Ta=25°C

ITEM	SYMBOL	MIN	TYP	MAX	UNIT	NOTE
Power Supply Voltage	V <sub>DD</sub>	4.75	5.0	5.25	V	
Input Voltage for Logic Signals	High	V <sub>IH</sub>	0.7 V <sub>DD</sub>	-	V <sub>DD</sub>	(1)
	Low	V <sub>IL</sub>	V <sub>SS</sub>	-	0.3 V <sub>DD</sub>	(1)
Power Supply Current	I <sub>DD</sub>	170	230	300	mA	(2),(3),(4)
V <sub>sync</sub> Frequency	f <sub>v</sub>	-	60	-	Hz	
H <sub>sync</sub> Frequency	f <sub>h</sub>	-	31.78	-	kHz	
Main Frequency	f <sub>DCLK</sub>	-	25.175	30	MHz	

Note (1) Display data pins and timing signal pins are subjected.  
 (2) f<sub>v</sub>=60Hz, f<sub>DCLK</sub> =25MHz, V<sub>DD</sub> = 5.0V, DC Current.

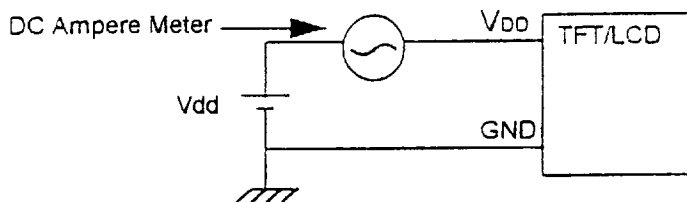

- (3) Current capacity for VDD power source should be larger than 3A.
- (4) Power dissipation check pattern

#### 1. Minimum Power Dissipation

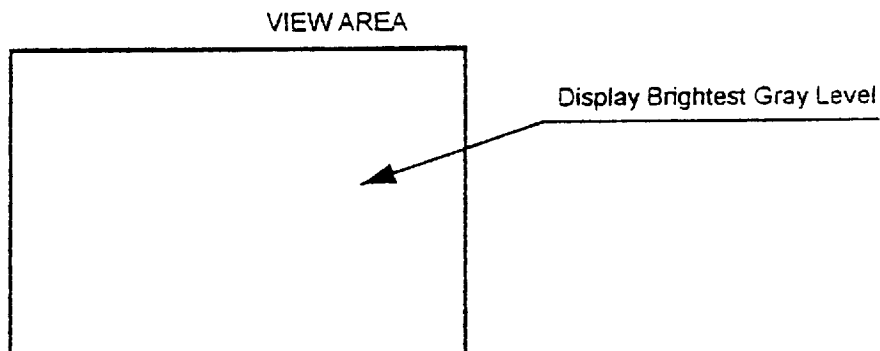



## 2. Typical Power Dissipation

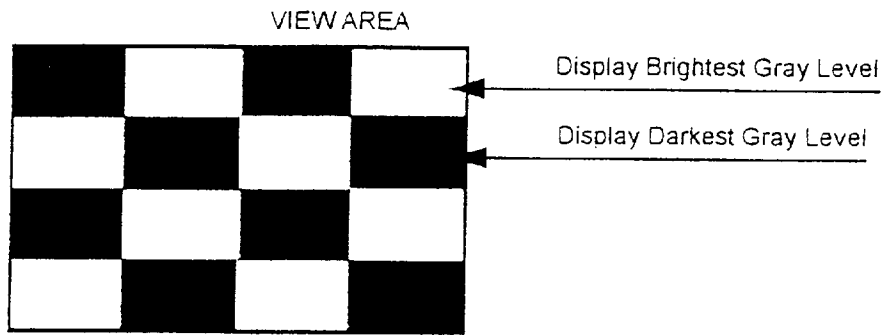

## 3. Maximum Power Dissipation

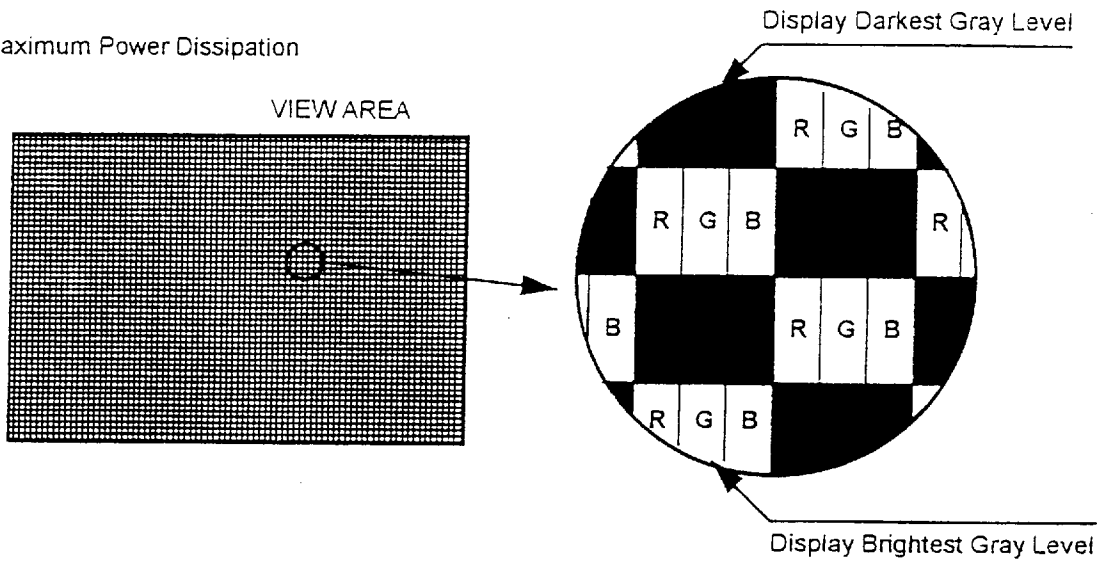

## (2) BACK-LIGHT UNIT

Ta=25°C

ITEM	SYMBOL	MIN	TYP	MAX	UNIT	NOTE
Lamp Current	$I_L$	2.0	3.5	6.0	mArms	(1)
Lamp Voltage	$V_L$	-	510	-	Vrms	
Frequency	$f_L$	-	40	-	kHz	
Start-up Voltage	$V_S$	-	-	950	Vrms	(2)
Lamp Power	$P_L$	-	2.0	-	W	
Lamp Life Time	$H_r$	10,000	-	-	Hour	(3)
Lamp Startup Time		-	30	1,000	msec	

Note (1) Higher  $I_L$  cause the short life time of CCFL

(2) 1400 Vrms at Ta = 0 °C

(3) Brightness become 50% of the original brightness at the standard condition.

(4) Max lamp startup time is less than 1sec, typical 30ms

# 4. BLOCK DIAGRAM

## (1) TFT LCD MODULE

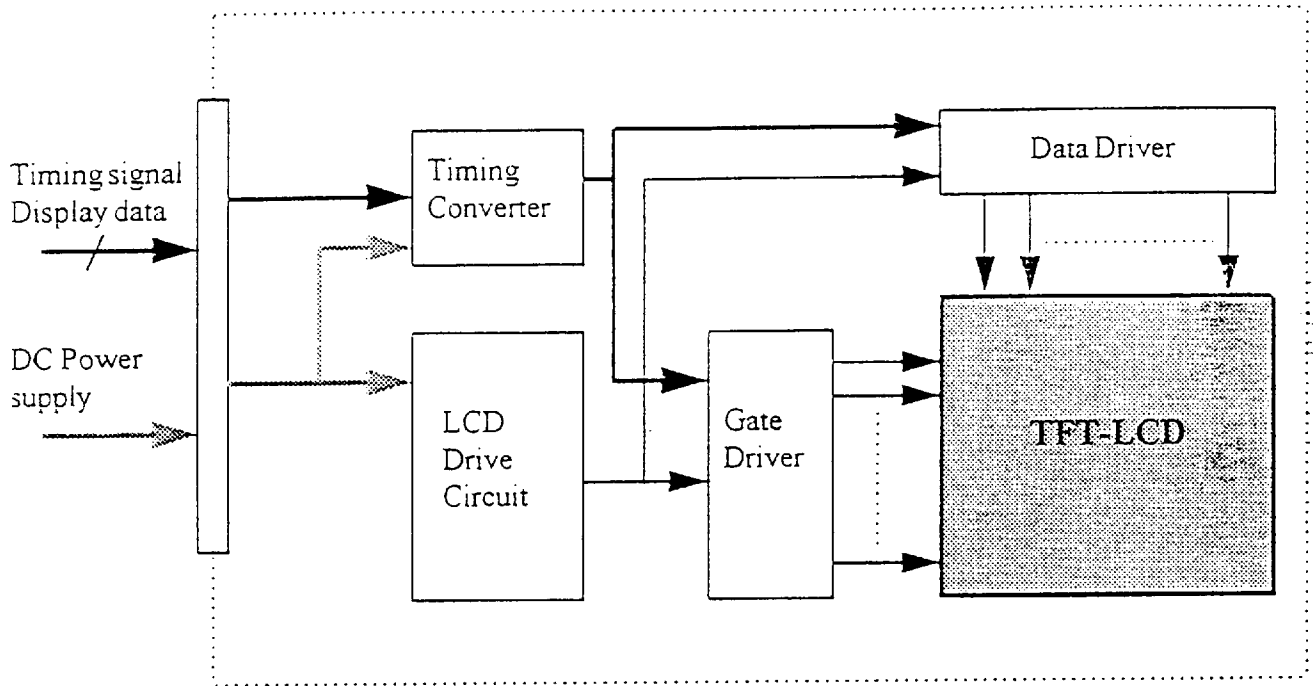

## (2) BACK-LIGHT UNIT

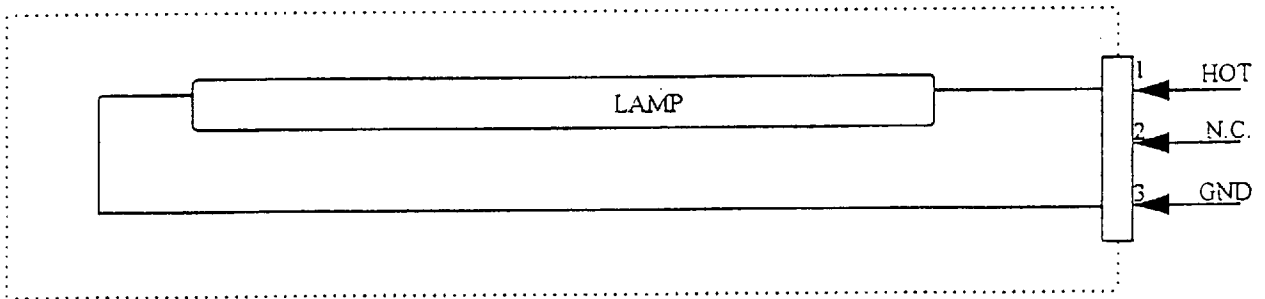

## 5. INPUT TERMINAL PIN ASSIGNMENT

(1) TFT LCD MODULE ( interface signals & power ) Connector : Hirose DF9-31P-1V

Pin NO.	Symbol	Function	Polarity	Note
1	GND	Power Ground	-	-
2	CLK	Data Clock	-	(1)
3	HSYNC	Horizontal Sync Signal	Negative	-
4	VSNC	Vertical Sync Signal	Negative	-
5	GND	Power Ground	-	-
6	R0	Red Data ( LSB )	Positive	(2)
7	R1	Red Data	"	
8	R2	Red Data	"	
9	R3	Red Data	"	
10	R4	Red Data	"	
11	R5	Red Data ( MSB )	"	
12	GND	Power Ground	-	-
13	G0	Green Data ( LSB )	Positive	(2)
14	G1	Green Data	"	
15	G2	Green Data	"	
16	G3	Green Data	"	
17	G4	Green Data	"	
18	G5	Green Data ( MSB )	"	
19	GND	Power Ground	-	-
20	B0	Blue Data ( LSB )	Positive	(2)
21	B1	Blue Data	"	
22	B2	Blue Data	"	
23	B3	Blue Data	"	
24	B4	Blue Data	"	
25	B5	Blue Data ( MSB )	"	
26	GND	Power Ground	-	-
27	DE [DTMG]	Data Enable ( Display Timing )	Positive	-
28	VDD	Power Supply ( +5V )	-	-
29	VDD	Power Supply ( +5V )	-	-
30	VDD	Power Supply ( +5V )	-	-
31	N.C.	No Connection	-	Open

Note (1). Display Data is sampled at the positive edge of Data Clock.

(2). Data level 0 means black data.

(2) BACK LIGHT UNIT

Connector : JST BHR-03VS-1

Pin NO.	Symbol	Function
1	HOT	High Voltage
2	N.C.	No Connection
3	GND	Ground

## 6. INTERFACE TIMING

### 6-1. Timing Parameters

Signal	Item	Symbol	Mode	MIN	TYP	MAX	Unit	Note
Clock	Frequency	$1/T_c$	ALL	-	35.175	28.322	MHz	
	High Time	$T_{CH}$	ALL	5	-	-	nsec	
	Low Time	$T_{CL}$	ALL	10	-	-	nsec	
Data	Setup Time	$T_{OS}$	ALL	5	-	-	nsec	
	Hold Time	$T_{OH}$	ALL	10	-	-	nsec	
Data Enable	Setup Time	$T_{ES}$	ALL	5	-	-	nsec	(1)
Horizontal Sync	Cycle	$T_H$	ALL	-	31.78	-	usec	
			ALL	770	800	900	clock	
	Pulse Width	$T_{HP}$	ALL	-	96	-	clock	
Vertical Sync	Cycle	$T_V$	480	-	16.7	525	msec	lines
			400	-	14.3	449	msec	lines
			350	-	14.3	449	msec	lines
	Pulse Width	$T_{VP}$	480	1	2	30	lines	(2)
			400	1	2	4	lines	
			350	1	2	4	lines	
Horizontal Signal	Display Start	$T_{HS}$	ALL	130	144	-	clock	
	Display period	$T_{HD}$	ALL	-	640	-	clock	
Vertical Signal	Display Start	$T_{VS}$	480	-	34	-	lines	
			400	-	34	-	lines	
			350	-	61	-	lines	
	Display Period	$T_{VD}$	480	-	480	-	lines	
			400	-	400	-	lines	
			350	-	350	-	lines	
Hsync - Vsync Phase Difference	Front	$T_{VHD}$	ALL	-320	-	40	nsec	

Note (1). The duration of DE [DTMG] signal must be longer than 1 clock period at every horizontal period

(2). The 400 and 350 line mode is centered automatically in Sync mode but not in DE mode

## 6-2. Timing diagrams of interface signal

### 1) Display Signal Timing Diagram(480 Line Mode)

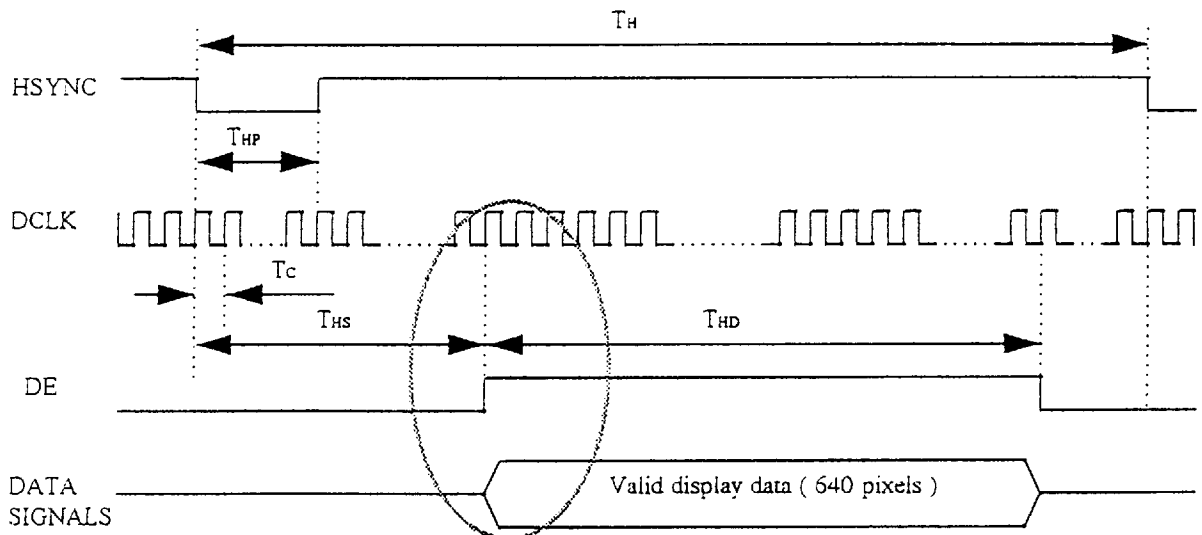
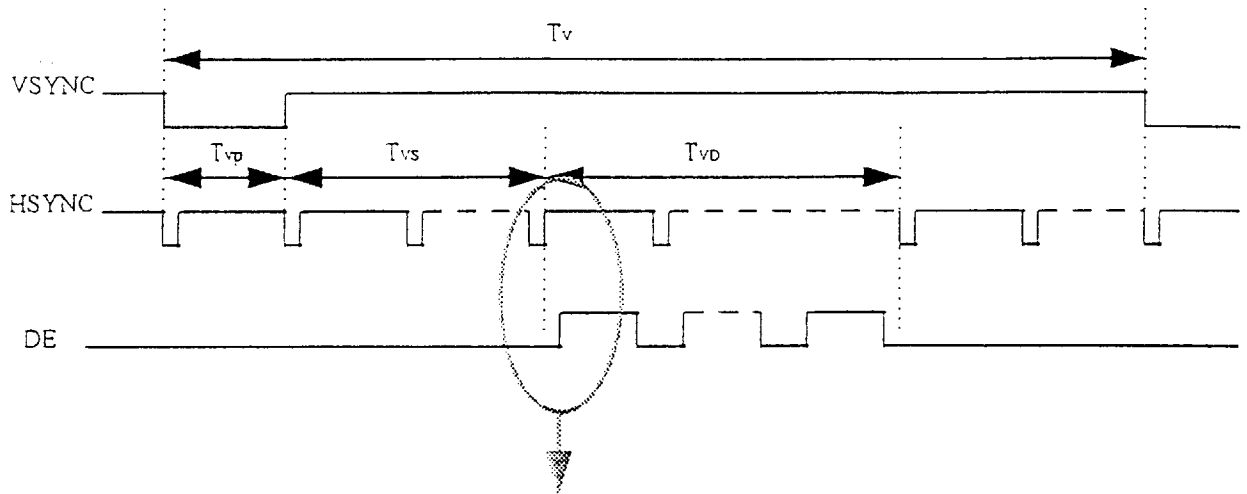

#### - Signal Transition Timing

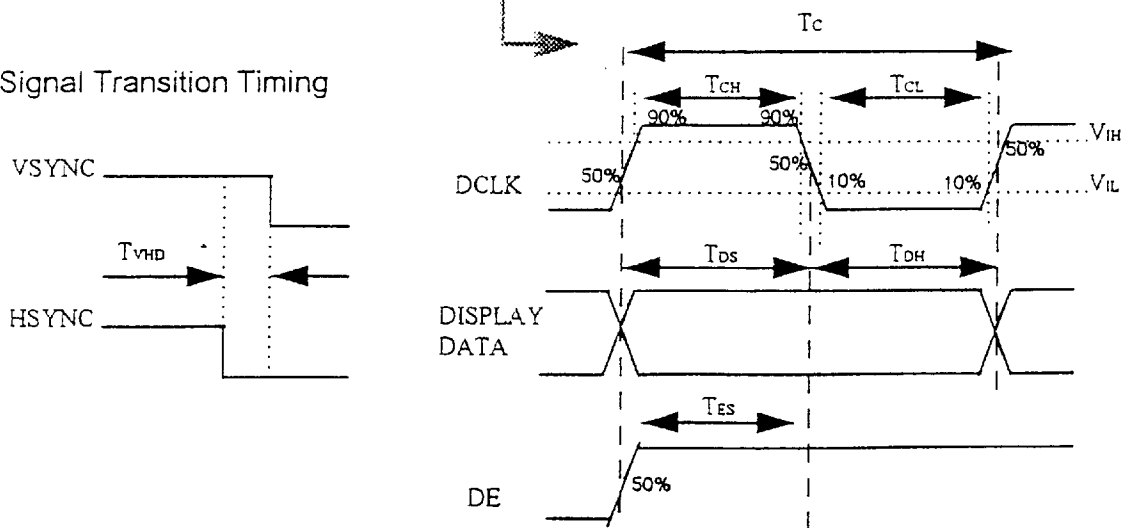

## 2) Display Signal Timing Diagram (400 Line Mode)

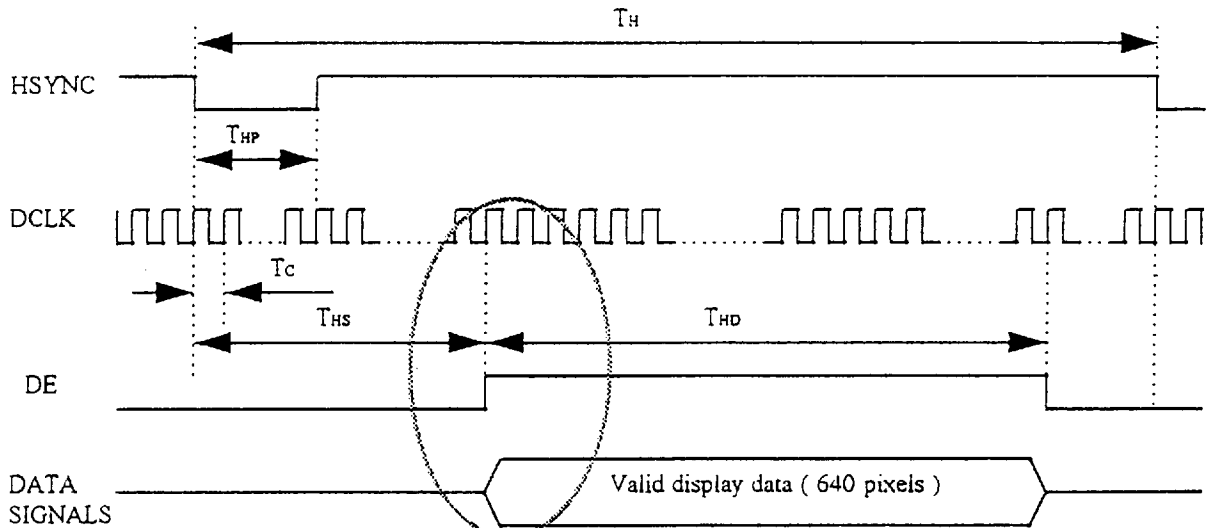
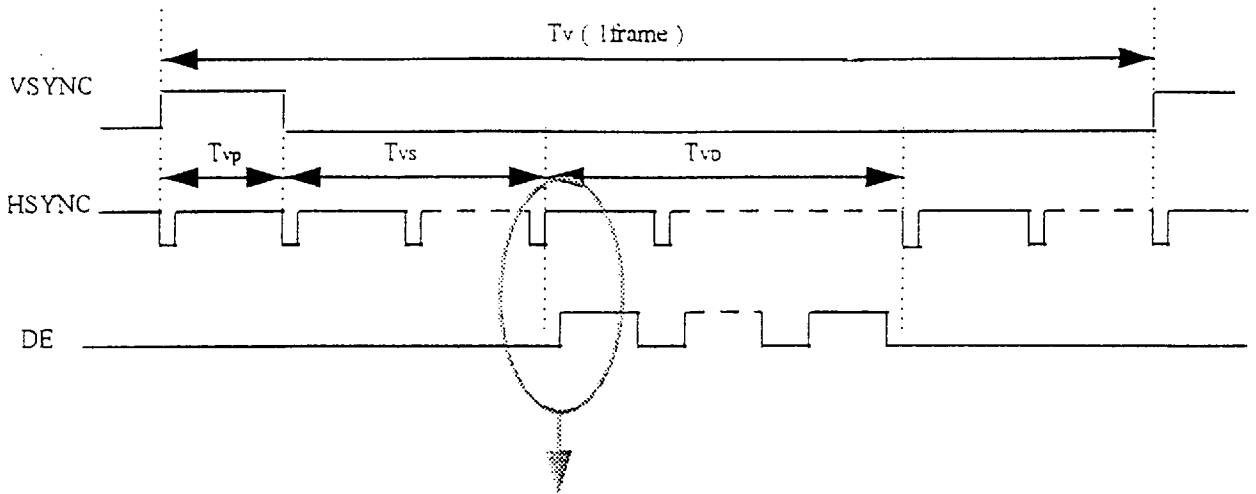

### - Signal Transition Timing

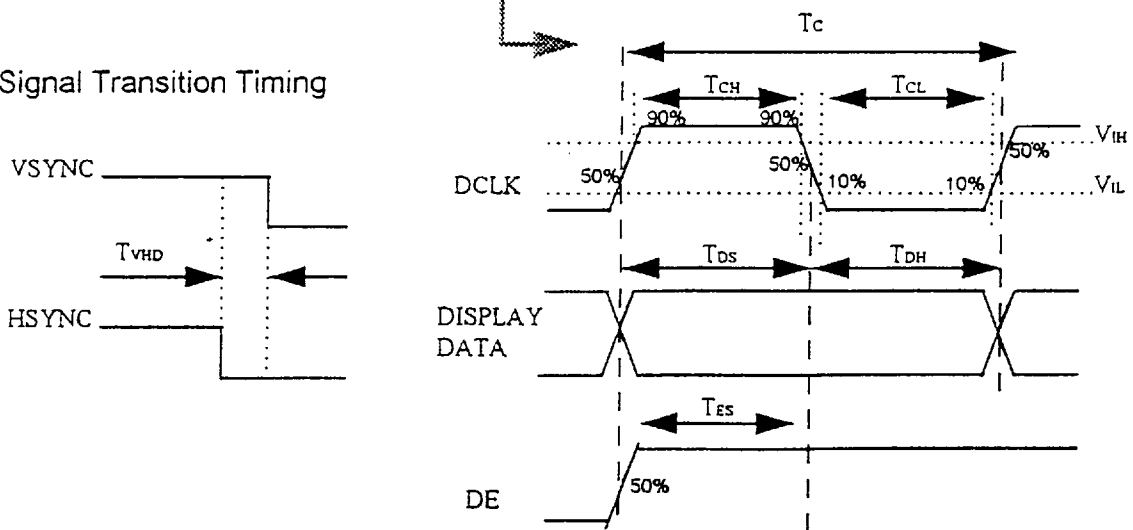

### 3) Display Signal Timing Diagram (350 Line Mode)

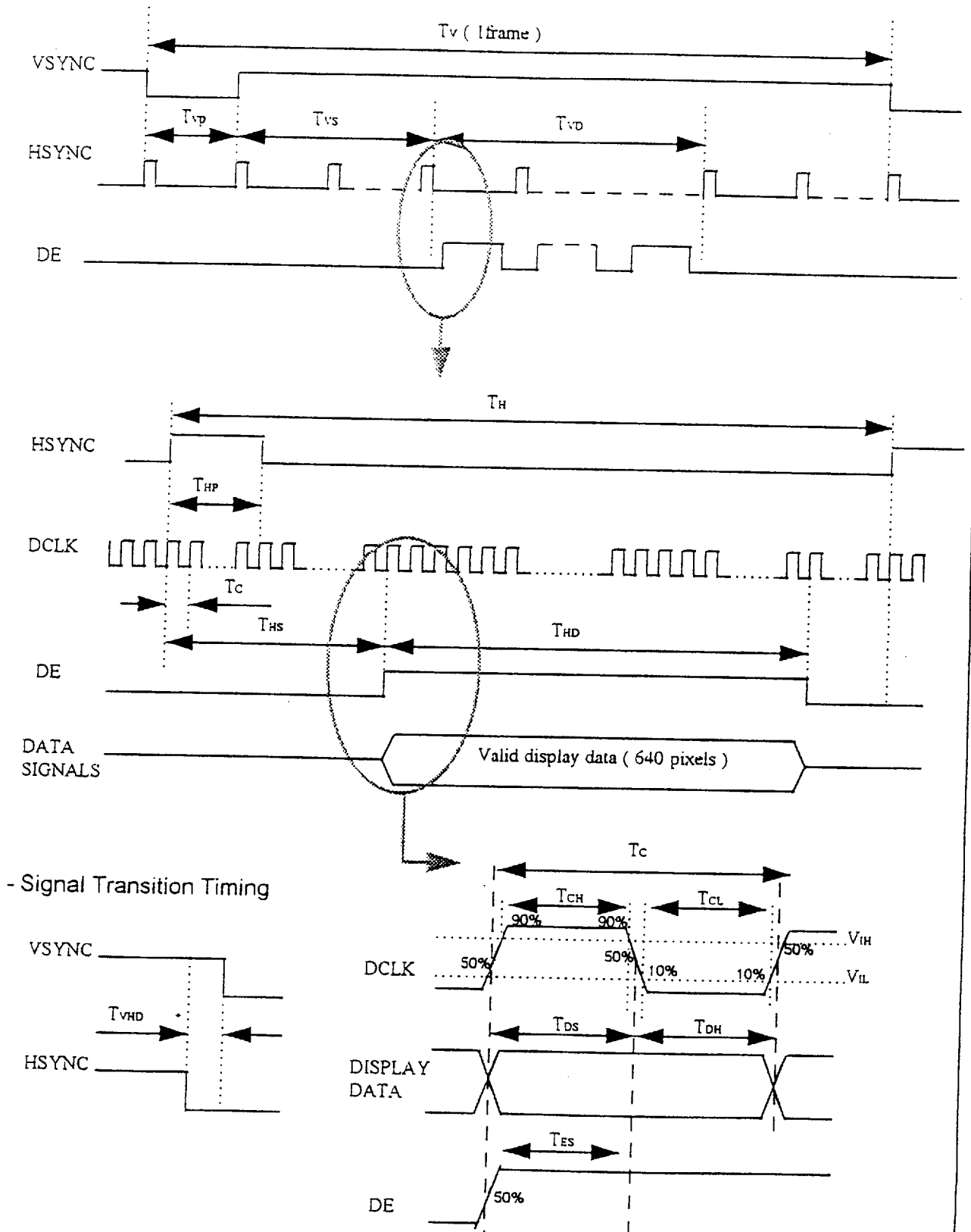

### 6-3. Input Signals, Basic Display Colors and Gray Scale of Each Color

Color & Gray scale	Data Signal																	
	R0	R1	R2	R3	R4	R5	G0	G1	G2	G3	G4	G5	B0	B1	B2	B3	B4	B5
Black	0	0	0	0	0	0	0	0	0	0	0	0	0	0	0	0	0	0
Blue	0	0	0	0	0	0	0	0	0	0	0	0	1	1	1	1	1	1
Green	0	0	0	0	0	0	1	1	1	1	1	1	0	0	0	0	0	0
Light blue	0	0	0	0	0	0	1	1	1	1	1	1	1	1	1	1	1	1
Red	1	1	1	1	1	1	0	0	0	0	0	0	0	0	0	0	0	0
Purple	1	1	1	1	1	1	0	0	0	0	0	0	1	1	1	1	1	1
Yellow	1	1	1	1	1	1	1	1	1	1	1	1	0	0	0	0	0	0
White	1	1	1	1	1	1	1	1	1	1	1	1	1	1	1	1	1	1
Black ↑ ↓ Red	0	0	0	0	0	0	0	0	0	0	0	0	0	0	0	0	0	0
	1	0	0	0	0	0	0	0	0	0	0	0	0	0	0	0	0	0
	0	1	0	0	0	0	0	0	0	0	0	0	0	0	0	0	0	0
				^						^						^		
				.						.						.		
				v						v						v		
	1	0	1	1	1	1	0	0	0	0	0	0	0	0	0	0	0	0
0	1	1	1	1	1	0	0	0	0	0	0	0	0	0	0	0	0	
1	1	1	1	1	1	0	0	0	0	0	0	0	0	0	0	0	0	
Black ↑ ↓ Green	0	0	0	0	0	0	0	0	0	0	0	0	0	0	0	0	0	0
	0	0	0	0	0	0	1	0	0	0	0	0	0	0	0	0	0	0
	0	0	0	0	0	0	0	1	0	0	0	0	0	0	0	0	0	0
				^						^						^		
				.						.						.		
				v						v						v		
	0	0	0	0	0	0	1	0	1	1	1	1	0	0	0	0	0	0
0	0	0	0	0	0	0	1	1	1	1	1	0	0	0	0	0	0	
0	0	0	0	0	0	1	1	1	1	1	1	0	0	0	0	0	0	
Black ↑ ↓ Blue	0	0	0	0	0	0	0	0	0	0	0	0	0	0	0	0	0	0
	0	0	0	0	0	0	0	0	0	0	0	0	1	0	0	0	0	0
	0	0	0	0	0	0	0	0	0	0	0	0	0	1	0	0	0	0
				^						^						^		
				.						.						.		
				v						v						v		
	0	0	0	0	0	0	0	0	0	0	0	0	1	0	1	1	1	1
0	0	0	0	0	0	0	0	0	0	0	0	0	1	1	1	1	1	
0	0	0	0	0	0	0	0	0	0	0	0	1	1	1	1	1	1	

0 : Low level voltage  
 1 : High level voltage

Note. MSB is R5, G5 & B5 and LSB is R0, G0 and B0



#### 6-4. Power ON/OFF Sequence

: To prevent a latch-up or DC operation of the LCD module, the power on/off sequence shall be as shown below.

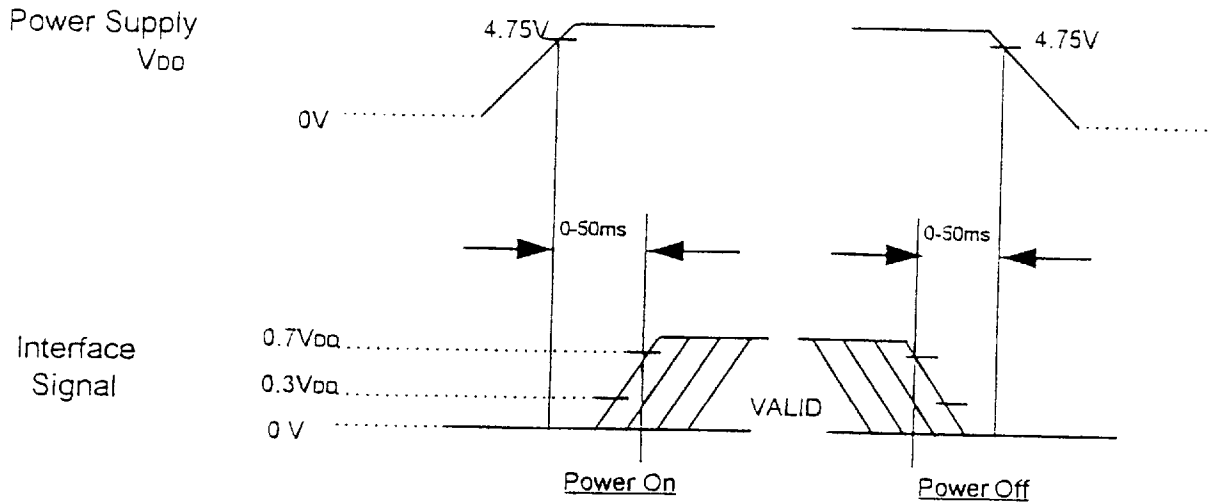

Power ON/OFF Sequence

\*. Set  $0\text{ V} < V_1(t) < V_{pp}(t)$

Here,  $V_1(t)$ ,  $V_{pp}(t)$  indicate the transit state of  $V_1$ ,  $V_{pp}$  when the power supply is turned ON or OFF

NOTE. Do not keep the interface signal high-impedance when power is on.



## 8. RELIABILITY TEST

No.	Test Item	Condition
1	High temperature storage test	Ta = 60 °C, 250hr
2	Low temperature storage test	Ta = 25 °C, 250hr
3	High temperature & high humidity operation test	Ta = 40 °C, 95%, 250hr (No condensation)
4	High temperature operation test	Ta = 50°C, Dynamic, 250hr
5	Low temperature operation test	Ta = 0 °C, Dynamic, 250hr
6	Vibration test (non-operating)	Frequency : 10 - 55 -10 Hz Stroke : 1.5mm Test period : 6 hr (2hr for each direction of X,Y,Z)
7	Shock test (non-operating)	Max. gravity : 100G Pulse width : 6ms, half sine wave Direction : ± X, ±Y, ±Z One time for each direction
8	Thermal shock	-20°C (0.5 hr) 60°C (0.5hr) 50 Cycle
9	Electrostatic Discharge Test	200 pF, 0 ohm ± 200V(terminals) ± 5000V(chassis)

### [ Result Evaluation Criteria]

Under the display quality test conditions with normal operation state, these shall be no change which may affect practical display function.

## 9. PACKING, TRANSPORTATION, AND DELIVERY

Supplier will pack products to be delivered to customer in accordance with supplier's packing specifications, and will deliver them to customer in such a state that they will not suffer damage during transportation. The delivery conditions are as follows.

### (1) Outer box

As shown in the figure, one or two inner boxes are packed in an outer box. There is a risk of damage to the products if the outer box is dropped from a height of 70cm or more, and therefore care should be taken in handling the box during transportation.

When a box is stored in a warehouse, etc., care should be taken to ensure that the storage temperature is not exceeded.

### (2) Inner box

The parts number and quantity are shown on the inner box, either printed directly or on a label.

Products should not be transported in the inner box alone, since there is a risk of damage. Moisture-proofing material silicagel is to be placed on the inner boxes, and they are then to be covered in moisture-proof vinyl sheet.

### (3) Means of transportation

Products are to be transported by hand, light van, truck, by air

Doc.No.	LT104V3-102-01	Rev.No	0.1	Date	Apr.28.95	Page	20 /23
---------	----------------	--------	-----	------	-----------	------	--------

# 10. MARKINGS

A nameplate bearing the following information is affixed to a shipped product at the specified location on each product.

(1) Parts number : 1AA 000 - 00 - 00

(2) Revision : One letter

(3) Control code : One letter

(4) Lot number : 1 A A 000 A-00

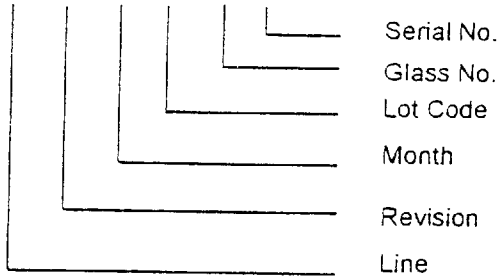

(5) Indication examples Nameplate

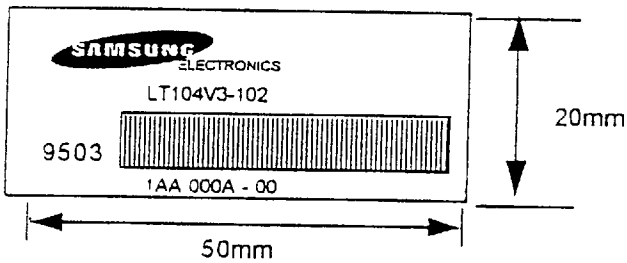

Parts name  
Lot number  
Inspection work week

High voltage caution label

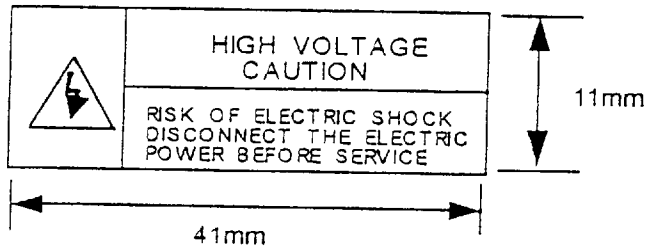

High voltage caution

## 11. PRODUCT INSPECTION

When products are shipped, incoming inspection shall be carry out with a sampling inspection based on MIL-STD-105E level II by AQL 1.0%.

### CHANGE CONTROL

Design changes may be made for this product relating to the specifications, appearance, parts used, circuits, etc., for the purpose of product improvement. If a design change is judged to affect the specifications of this product, supplier shall inform customer of the change in advance.

### QUALITY CONTROL

In the event of a product failure under normal operating conditions, and in the event of product trouble or a functional disorder that can be deemed to be the responsibility of supplier, supplier shall repair the fault or replace the product free of charge within one year of the product delivery date. However, supplier shall not bear responsibility for the quality of a product in the case of modifications other than those specified by supplier.

### MAINTENANCE

The specifications of the functions of maintenance parts may be partially changed with in a range which provides for equivalent or better quality. Maintenance parts shall in principle be product units. If manufacture of this product is stopped, supplier shall notify customer in advance.

### HANDLING OF DOUBTFUL POINTS

If any doubt arises concerning a matter not stipulated in this specification, the matter is to be resolved by mutual agreement between customer and supplier, and supplier shall make efforts for improvement in good faith.

Doc.No.	LT104V3-102-01	Rev.No	0.1	Date	Apr.28.95	Page	22 / 23
---------	----------------	--------	-----	------	-----------	------	---------