



ELECTRONICS

Approval

TO :

DATE : April. 21, 1999

SAMSUNG TFT-LCD
MODEL NO. : LT121SS-105

NOTE :

The information described in this SPEC is preliminary and can be changed without prior notice.

APPROVED BY : B. W. Lee

PREPARED BY : Application Engineering Group

SAMSUNG ELECTRONICS CO., LTD.

CONTENTS

Revision History	----- (3)
General Description	----- (4)
1. Absolute Maximum Ratings	----- (5)
1.1 Environmental Conditions	
1.2 Electrical Absolute Ratings	
2. Optical Characteristics	----- (7)
3. Electrical Characteristics	----- (11)
3.1 TFT LCD Module	
3.2 Backlight Unit	
4. Block Diagram	----- (14)
4.1 TFT LCD Module	
4.2 Backlight Unit	
5. Input Terminal Pin Assignment	----- (15)
5.1 Input Signal & Power	
5.2 Backlight Unit	
5.3 Pixel format	
5.4 Input Signals, Basic Display Colors and Gray Scale of Each Color.	
6. Interface Timing	----- (18)
6.1 Timing Parameters	
6.2 Timing Diagrams of interface Signal	
6.3 Power ON/OFF Sequence	
7. Outline Dimension	----- (21)
8. General Precautions	----- (22)

Revision History

Approval

Date	Rev.No.	Summary	Page
April.21.'99	007	First issued for a general specification	

GENERAL DESCRIPTION

Approval

DESCRIPTION

LT121SS-105 is a color active matrix TFT (Thin Film Transistor) liquid crystal display (LCD) that uses amorphous silicon TFT as a switching devices. this model is composed of a TFT LCD panel, a driver circuit and a backlight system. The resolution of a 12.1" contains 800 x 600 pixels and can display up to 262,144 colors. 6 o'clock direction is the optimum viewing angle.

FEATURES

- Thin - Light weight
- High contrast ratio, High aperture structure.
- High-speed response
- SVGA (800 x600 pixels) resolution
- Low power consumption
- Single CCFL(Cold Cathode Fluorescent Lamp)
- Sync & DE (Data enable) mode.
- 3.3V Power Supply

APPLICATIONS

- Notebook PC and desktop monitors
- Display terminals for AV application products
- Monitors for Industrial machine
- If the usage of this product is not for PC application, but for others, please contact SEC.

General Information

ITEM	SPECIFICATION	UNIT	NOTE
Display area	246.0(H) x 184.5(V) (12.1"diagonal)	mm	
Driver element	a-si TFT active matrix		
Display colors	262,144		
Number of pixel	800 x 600	pixel	
Pixel arrangement	RGB vertical stripe		
Pixel pitch	0.3075 (H) x 0.3075 (V) (TYP.)	mm	
Display Mode	Normally white		
Surface treatment	Haze 25, Hard-Coating (3H)		

Mechanical Information

ITEM		MIN.	TYP.	MAX.	NOTE
Module size	Horizontal (H)	274.5	275.0	275.5	
	Vertical (V)	198.8	199.3	199.8	
	Depth (D)	-	-	6.8	
Weight		-	-	455g	

1. ABSOLUTE MAXIMUM RATINGS

1.1 ABSOLUTE RATINGS OF ENVIRONMENT

ITEM	SYMBOL	MIN.	MAX.	UNIT	NOTE
Storage temperate	T_{STG}	-20	60	°C	(1)
Operating temperate (Temperature of glass surface)	T_{OPR}	0	50	°C	(1)
Shock (nonoperating)	Snop	-	100	G	(2),(4)
Vibration (nonoperating)	Vnop	-	1.0	G	(3),(4)

Note (1) Temperature and relative humidity range are shown in the figure below.

95 % RH Max. ($40\text{ }^{\circ}\text{C} \geq T_a$)

Maximum wet - bulb temperature at $39\text{ }^{\circ}\text{C}$ or less. ($T_a > 40\text{ }^{\circ}\text{C}$) No condensation.

(2) 6 ms, half sine wave, one time for $\pm X, \pm Y, \pm Z$.

(3) 10 - 55 - 10 Hz, Sweep rate 2.5 min, 120 min for X, Y, Z.

(4) At testing Vibration and Shock, the fixture in holding the Module to be tested have to be hard and rigid enough so that the Module would not be twisted or bent by the fixture.

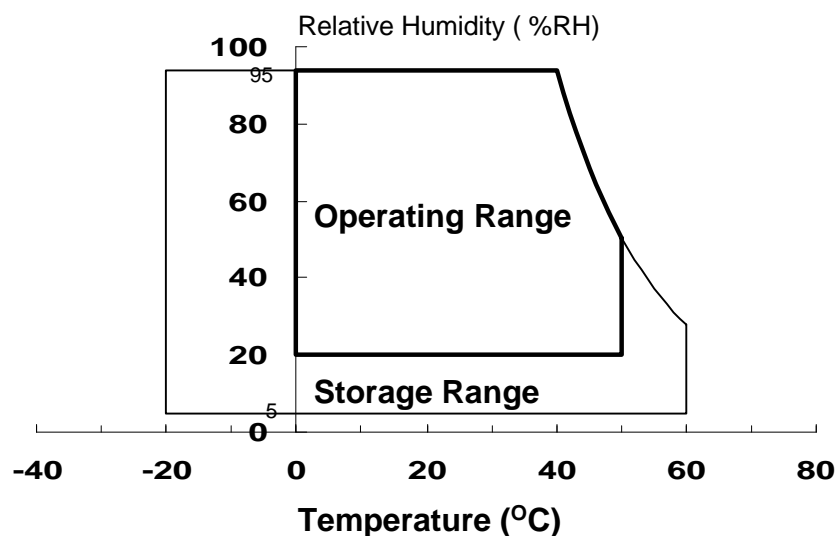

1.2 ELECTRICAL ABSOLUTE RATINGS

(1) TFT LCD MODULE

(GND= 0 V)

ITEM	SYMBOL	MIN.	MAX.	UNIT	NOTE
Power Supply Voltage	V _{DD}	GND-0.3	6.0	V	(1)
Logic Input Voltage	V _{IN}	GND-0.3	V _{DD} +0.3	V	(1)
Electro-static Durability	V _{ESD,C}	+/- 10		KV	(2), (3)
	V _{ESD,A}	+/- 20		KV	(2), (4)

NOTE (1) Within Ta (25 ± 2 °C)

(2) 150pF, 330ohm

(3) Interface connector pins are subjected.

(4)The surface of metal chassis are subjected.

(2) BACK-LIGHT UNIT

Ta = 25 ± 2 °C

ITEM	SYMBOL	MIN.	MAX.	UNIT.	NOTE
Lamp current	I _L	2.0	5.0	mA _{rms}	(1)
Lamp frequency	F _L	35	60	KHz	(1)

NOTE (1) Permanent damage to the device may occur if maximum values are exceeded.
Functional operation should be restricted to the conditions described under Normal Operating Conditions.

2. OPTICAL CHARACTERISTICS

The following items are measured under stable conditions. The optical characteristics should be measured in a dark room or equivalent state with the methods shown in Note (5).

Measuring equipment : TOPCON BM-5A

* Ta = 25 ±2°C , VDD=3.3V, fv= 60Hz, fdCLK=40MHz, IL = 3.5 mA

ITEM	SYMBOL	CONDITION	MIN.	TYP.	MAX.	UNIT	NOTE
Contrast Ratio (5 Points)	CR		170	-	-		(1), (2), (5)
Response Time at 25°C	Rising	T _R	-	20	30	msec	(1), (3)
	Falling	T _F	-	30	50		
Average Luminance of White (5 Points)	Y _{L,AVE}		70	90	-	cd/m ²	(1), (4),(5)
Color Chromaticity (CIE)	Red	R _X	φ = 0, θ = 0 Normal Viewing Angle	0.549	0.579	0.609	(1), (5)
		R _Y		0.321	0.351	0.381	
	Green	G _X		0.274	0.304	0.334	
		G _Y		0.475	0.505	0.535	
	Blue	B _X		0.124	0.154	0.184	
		B _Y		0.106	0.136	0.166	
	White	W _X		0.269	0.299	0.329	
		W _Y		0.294	0.324	0.354	
Viewing Angle	Hor.	θ _L	CR ≥ 10 (at center point)	45	-	-	Degrees
		θ _R		45	-	-	
	Ver.	φ _H		10	-	-	
		φ _L		30	-	-	
13 Points White Variation	δ _L		-	-	1.75		(6)

Note 1) Definition of Viewing Angle : Viewing angle range ($10 \leq C/R$)

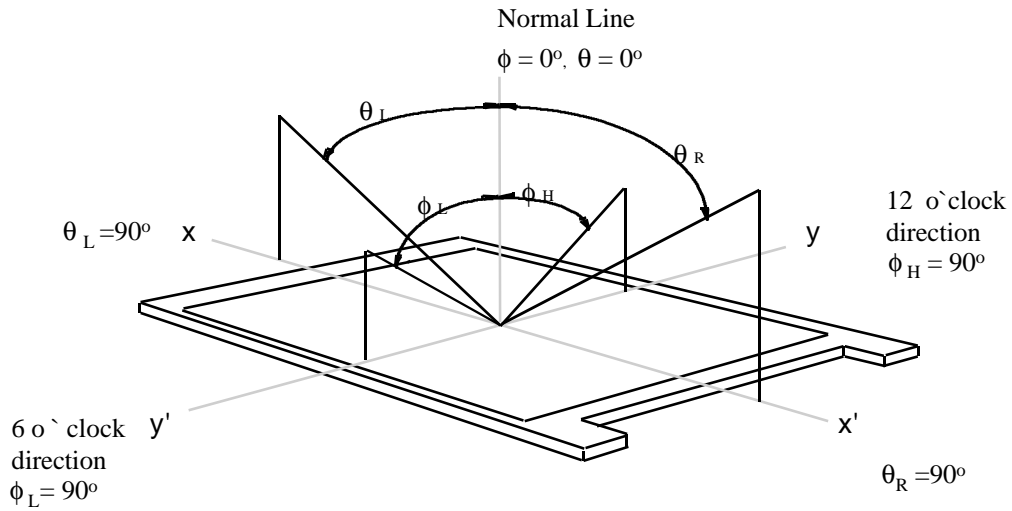

Note 2) Definition of Contrast Ratio (CR) : Ratio of gray max (Gmax) ,gray min (Gmin) at 5 points(4, 5, 7, 9, 10)

$$CR = \frac{CR(4) + CR(5) + CR(7) + CR(9) + CR(10)}{5}$$

POINTS : (4) , (5) , (7) , (9) , (10) at FIGURE OF NOTE 7)

Note 3) Definition of Response time : Sum of T_R, T_F

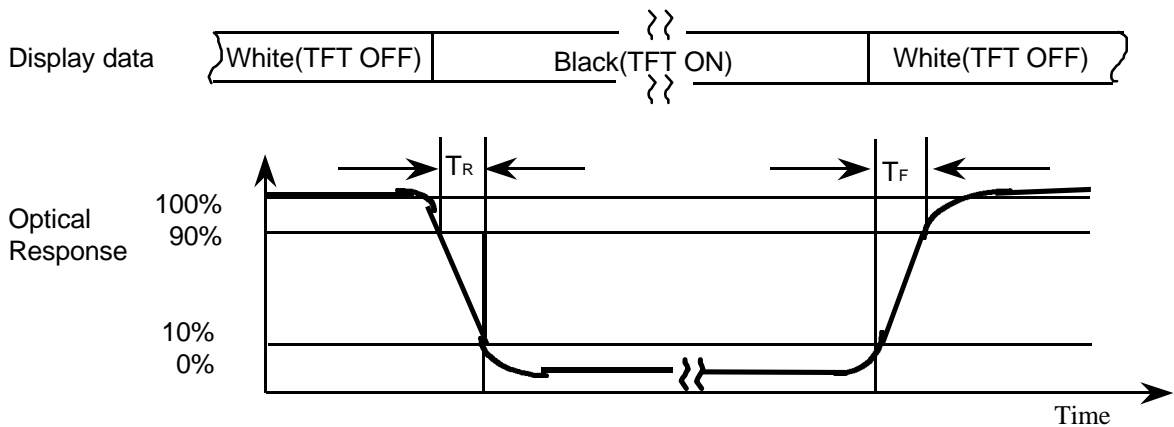

Note 4) Definition of Average Luminance of White : measure the luminance of white at 5 points.

Average Luminance of White ($Y_{L,AVE}$)

$$Y_{L,AVE} = \frac{Y_{L5} + Y_{L4} + Y_{L3} + Y_{L2} + Y_{L1}}{5}$$

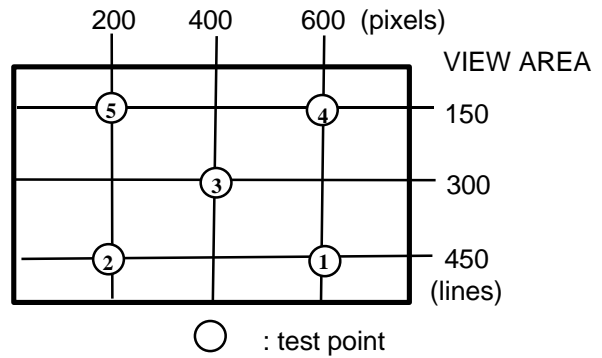

Note 5) After stabilizing and leaving the panel alone at a given temperature for 30 min , the measurement should be executed. Measurement should be executed in a stable, windless, and dark room. 30 min after lighting the backlight. This should be measured in the center of screen.
 Lamp current : 3.5mA
 Environment condition : $T_a = 25^{\circ}C \pm 0.5^{\circ}C$

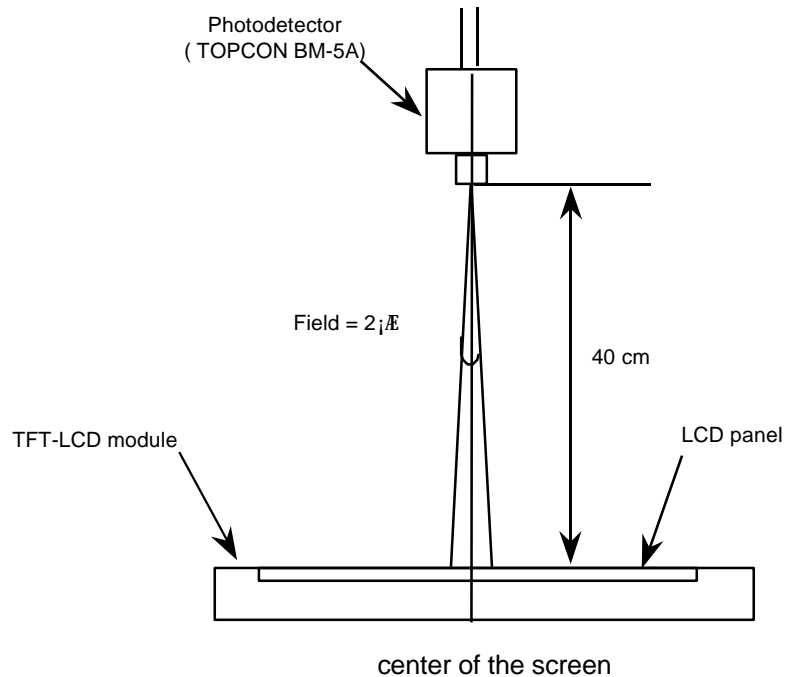

Optical characteristics measurement setup

Note 6) Definition of 13 points white variation (δ_w)

$$\delta_L = \frac{\text{Maximum luminance of 13 points}}{\text{Minimum luminance of 13 points}}$$

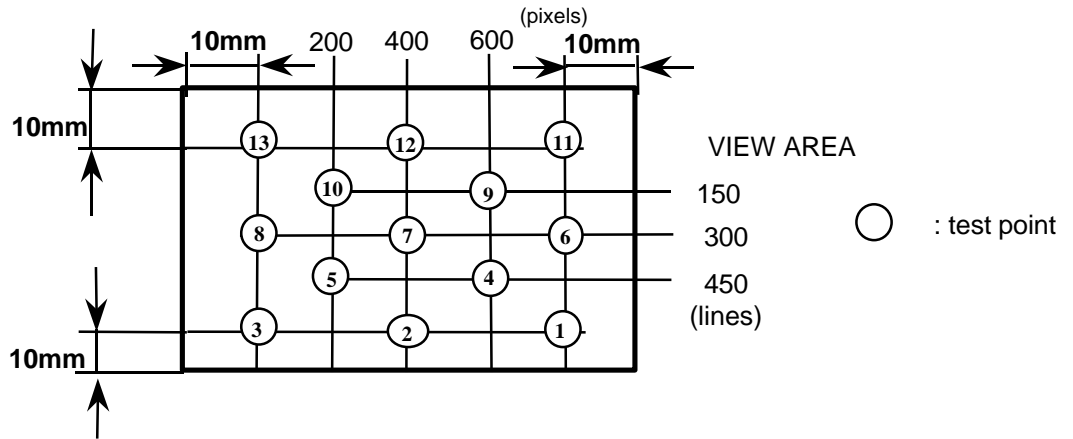

3. ELECTRICAL CHARACTERISTICS

Approval

3.1 TFT LCD MODULE

Ta=25°C ; ± 2 °C

ITEM	SYMBOL	MIN	TYP	MAX	UNIT	NOTE	
Voltage of Power Supply	V _{DD}	3.0	3.3	3.6	V		
Input Voltage for Logic Signals	High	V _{ih}	0.8V _{DD}	-	-	V	(1)
	Low	V _{il}	-	-	0.2V _{DD}	V	(1)
Vsync Frequency	f _v	-	60	-	Hz		
Hsync Frequency	f _H	-	37.879	-	kHz		
Main Frequency	f _{DCLK}	38	40	42	MHz		
Rush Current	I _{RUSH}	-	-	1.5	A	(4)	
Current of Power Supply	White	I _{DD}	-	210	-	mA	(2)(3) *a
	Mosaic		-	250	-	mA	(2)(3) *b
	V.Stripe		-	280	320	mA	(2)(3) *c

Note (1) Display data pins and timing signal pins should be connected.(GND=0V)

(2) f_v= 60Hz, f_{DCLK} = 40MHz, V_{DD} =3.3V, DC Current.

(3) Power dissipation pattern.

*a) White Pattern

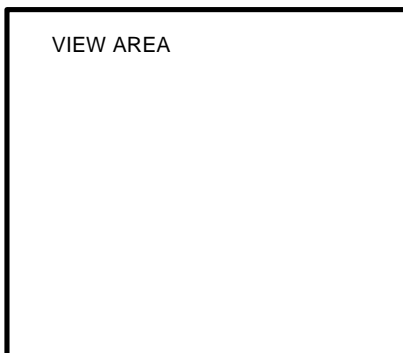

Display Brightest Gray Level →

Display Darkest Gray Level →

*b)Mosaic Pattern

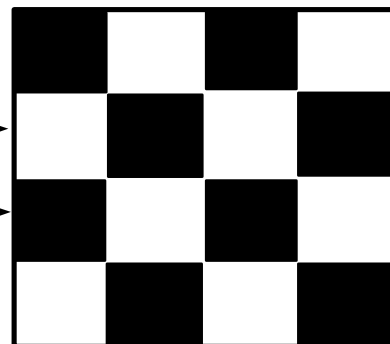

*c) Vertical stripe pattern

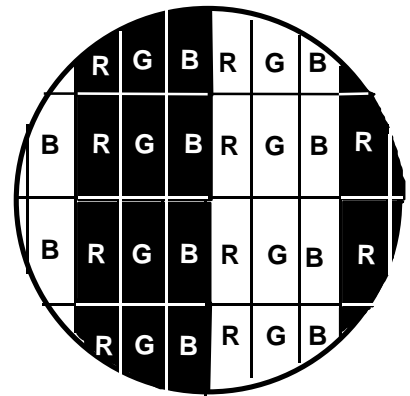
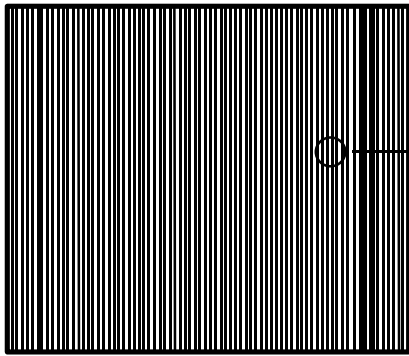

(4) Measurement Conditions

VDD Rising time : 470μs

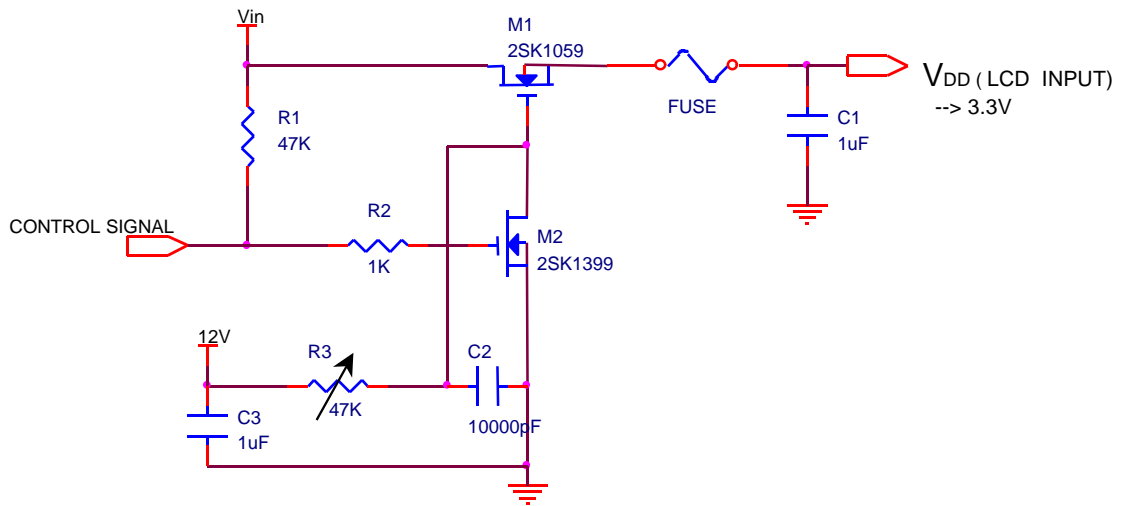

3.2 BACK-LIGHT UNIT

Approval

The backlight system is an edge - lighting type with a single CCFL(Cold Cathode Fluorescent Tube).
The characteristics of a single lamp are shown in the following tables.

INVERTER : SEC 130

LAMP : HMBOK22B62E255.5W/AX

Ta=25°C; 2°C

ITEM	SYMB	MIN	TYP	MAX	UNIT	NOTE
Lamp Current	I _L	2.0	3.5	5.0	mArms	(1)
Lamp Voltage	V _L	-	680	-	V _{rms}	I _L =3.5mA
Frequency	f _L	35	-	60	KHZ	(2)
Power Consumption	P _L	-	2.4	-	W	(3), I _L =3.5mA
Operating Life Time	Hr	10,000	-	-	Hour	(4)
Startup Voltage	V _s	-	-	1010 (25 °C)	V _{rms}	(5)
				1340 (0 °C)		

Note) The waveform of the inverter output voltage must be area symmetric and the design of the inverter must have specifications for the modularized lamp.

The performance of the backlight, for example life time or brightness, is much influenced by the characteristics of the DC-AC inverter for the lamp. So all the parameters of an inverter should be carefully designed so as not to produce too much leakage current from high-voltage output of the inverter. When you design or order the inverter, please make sure that a poor lighting caused by the mismatch of the backlight and the inverter(miss lighting, flicker, etc.) never occur. When you confirm it, the module should be operated in the same condition as it is installed in your instrument.

Note (1) Lamp current is measured with a high frequency current meter as shown below.

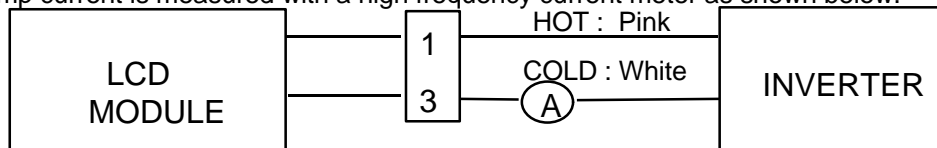

No 3 Pin is VLow.

(SIC130)

Switching Frequency : 35 ~ 60 KHz

(2) Lamp frequency may produce interference with horizontal synchronous frequency and this may cause line flow on the display. Therefore lamp frequency should be detached from the horizontal synchronous frequency and its harmonics as far as possible in order to avoid interference.

(3) refer to I_L ; √V_L to calculate.

(4) Life time (Hr) of a lamp can be defined as the time in which it continues to operate under the condition Ta = 25 °C ; 2°C and I_L = 2~5 mArms until one of the following event occurs.

1. When the brightness becomes 50% or lower than it's original.

2. When the Effective ignition length becomes 80% or lower than it's original value.

(Effective ignition length is defined as an area that has less than 70% brightness compared to the brightness in the center point.)

(5) The voltage above this value should be applied to the lamp for more than 1 second to startup. Otherwise the lamp may not be turned on.

4. BLOCK DIAGRAM

4.1 TFT LCD MODULE

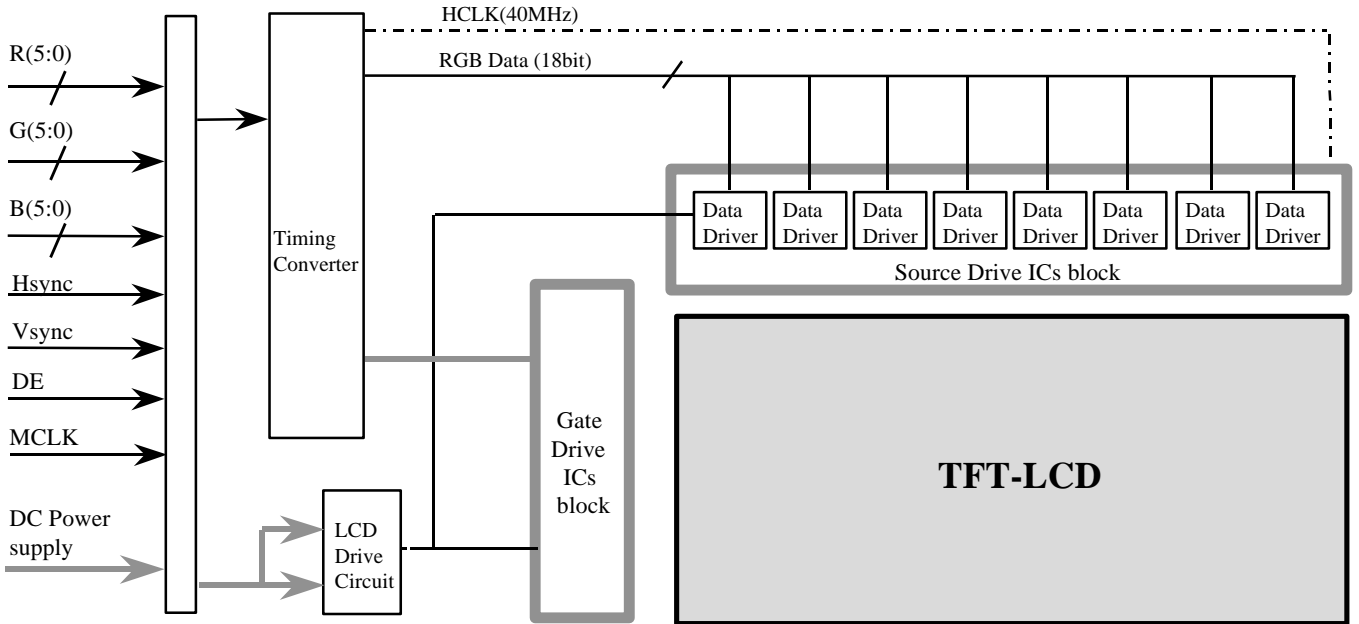

4.2 BACK-LIGHT UNIT

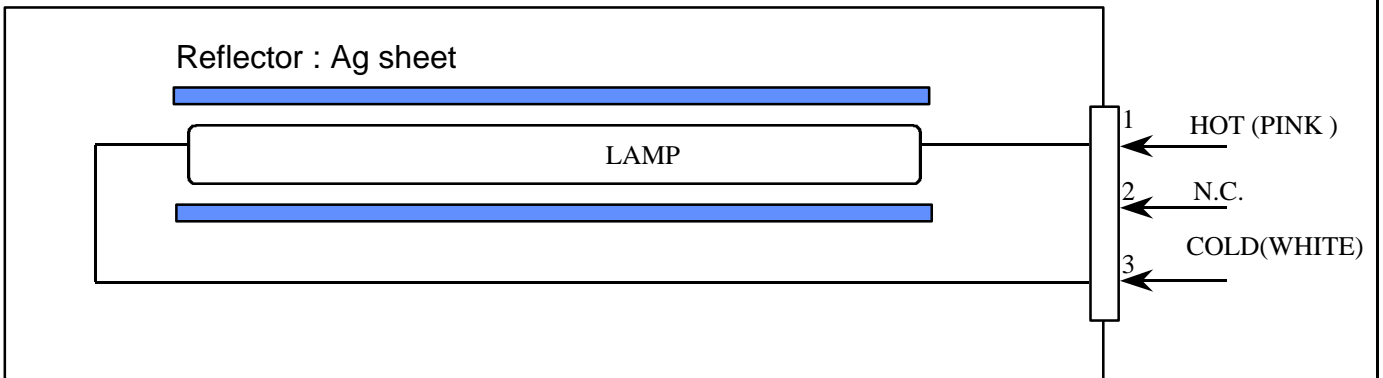

Note) The output of the inverter may change according to the material of the reflector.

5. INPUT TERMINAL PIN ASSIGNMENT

Approval

5.1. Input Signal & Power

Connector : Hirose DF9-41P-1V

Matching Connector : Hirose DF9-41S-1V(21)

Pin NO.	Symbol	Function	Polarity	Remark
1	GND	Power Ground	-	-
2	DCLK	Data Clock	-	(1)
3	GND	Power Ground	-	-
4	Hsync	Horizontal Sync Signal	Negative	-
5	Vsync	Vertical Sync Signal	Negative	-
6	GND	Power Ground	-	-
7	GND	Power Ground	-	-
8	GND	Power Ground	-	-
9	R0	Red Data [LSB]	Positive	(2)
10	R1	Red Data	Positive	
11	R2	Red Data	Positive	
12	GND	Power Ground	-	-
13	R3	Red Data	Positive	(2)
14	R4	Red Data	Positive	
15	R5	Red Data [MSB]	Positive	
16	GND	Power Ground	-	-
17	GND	Power Ground	-	-
18	GND	Power Ground	-	-
19	G0	Green Data [LSB]	Positive	(2)
20	G1	Green Data	Positive	
21	G2	Green Data	Positive	
22	GND	Power Ground	-	-
23	G3	Green Data	Positive	(2)
24	G4	Green Data	Positive	
25	G5	Green Data [MSB]	Positive	
26	GND	Power Ground	-	-
27	GND	Power Ground	-	-
28	GND	Power Ground	-	-
29	B0	Blue Data	Positive	(2)
30	B1	Blue Data	Positive	
31	B2	Blue Data	Positive	
32	GND	Power Ground	-	-
33	B3	Blue Data	Positive	(2)
34	B4	Blue Data	Positive	
35	B5	Blue Data [MSB]	Positive	
36	GND	Power Ground	-	-
37	DE [DTMG]	Data Enable [Display Timing]	Positive	-
38	N.C.	No Connection	-	Open
39	V _{DD}	Power Supply [+3.3V]	-	-
40	V _{DD}	Power Supply [+3.3V]	-	-
41	N.C.	No Connection	-	Open

Remark : (1) Display Data is sampled at the negative edge of Data Clock.

(2) Data level 0 means no color (Black).

5.2 BACK LIGHT UNIT

Connector : JST BHR-03VS-1
Matching Connector : H-JST5-6

Pin NO.	Symbol	Color	Function
1	HOT	PINK	High Voltage
2	N.C.	-	No Connection
3	COLD	WHITE	Low Voltage

5.3 PIXEL FORMAT

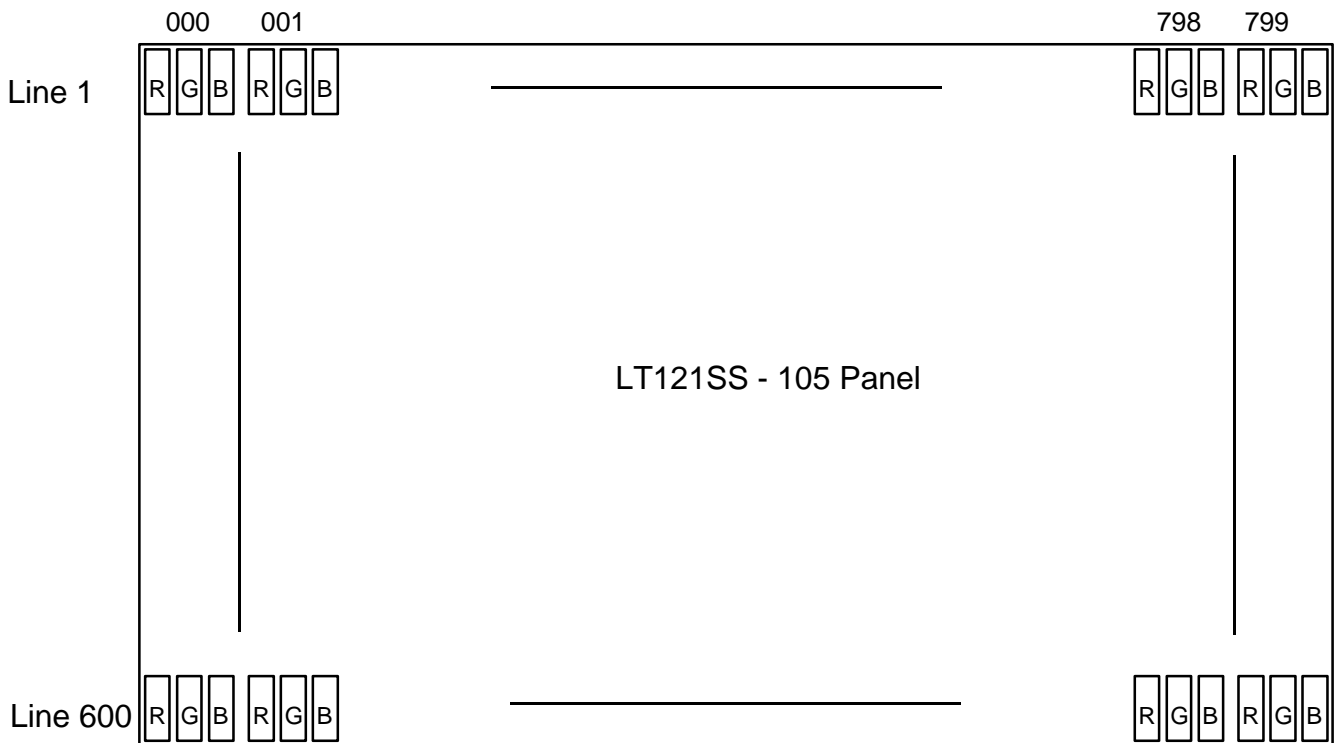

5.4 Input Signal, Basic Display Colors and Gray Scale of Each Colors

COLOR	DISPLAY	DATA SIGNAL																GRAY SCALE LEVEL	
		RED					GREEN					BLUE							
		R0	R1	R2	R3	R4	R5	G0	G1	G2	G3	G4	G5	B0	B1	B2	B3		B4
BASIC COLOR	BLACK	0	0	0	0	0	0	0	0	0	0	0	0	0	0	0	0	0	-
	BLUE	0	0	0	0	0	0	0	0	0	0	0	0	1	1	1	1	1	-
	GREEN	0	0	0	0	0	0	1	1	1	1	1	1	0	0	0	0	0	-
	CYAN	0	0	0	0	0	0	1	1	1	1	1	1	1	1	1	1	1	-
	RED	1	1	1	1	1	1	0	0	0	0	0	0	0	0	0	0	0	-
	MAGENTA	1	1	1	1	1	1	0	0	0	0	0	0	1	1	1	1	1	-
	YELLOW	1	1	1	1	1	1	1	1	1	1	1	1	0	0	0	0	0	-
	WHITE	1	1	1	1	1	1	1	1	1	1	1	1	1	1	1	1	1	-
GRAY SCALE OF RED	BLACK	0	0	0	0	0	0	0	0	0	0	0	0	0	0	0	0	R0	
	DARK jè	1	0	0	0	0	0	0	0	0	0	0	0	0	0	0	0	0	R1
		0	1	0	0	0	0	0	0	0	0	0	0	0	0	0	0	0	R2
		:	:	:	:	:	:	:	:	:	:	:	:	:	:	:	:	:	R3-R60
	jé LIGHT	:	:	:	:	:	:	:	:	:	:	:	:	:	:	:	:	:	
		1	0	1	1	1	1	0	0	0	0	0	0	0	0	0	0	0	R61
	0	1	1	1	1	1	0	0	0	0	0	0	0	0	0	0	0	0	R62
	RED	1	1	1	1	1	1	0	0	0	0	0	0	0	0	0	0	0	R63
GRAY SCALE OF GREEN	BLACK	0	0	0	0	0	0	0	0	0	0	0	0	0	0	0	0	G0	
	DARK jè	0	0	0	0	0	0	1	0	0	0	0	0	0	0	0	0	0	G1
		0	0	0	0	0	0	0	1	0	0	0	0	0	0	0	0	0	G2
		:	:	:	:	:	:	:	:	:	:	:	:	:	:	:	:	:	G3-G60
	jé LIGHT	:	:	:	:	:	:	:	:	:	:	:	:	:	:	:	:	:	
		0	0	0	0	0	0	1	0	1	1	1	1	0	0	0	0	0	G61
	0	0	0	0	0	0	0	0	1	1	1	1	1	0	0	0	0	0	G62
	GREEN	0	0	0	0	0	0	1	1	1	1	1	1	0	0	0	0	0	G63
GRAY SCALE OF BLUE	BLACK	0	0	0	0	0	0	0	0	0	0	0	0	0	0	0	0	B0	
	DARK jè	0	0	0	0	0	0	0	0	0	0	0	0	1	0	0	0	0	B1
		0	0	0	0	0	0	0	0	0	0	0	0	0	1	0	0	0	B2
		:	:	:	:	:	:	:	:	:	:	:	:	:	:	:	:	:	B3-B60
	jé LIGHT	:	:	:	:	:	:	:	:	:	:	:	:	:	:	:	:	:	
		0	0	0	0	0	0	0	0	0	0	0	0	1	0	1	1	1	B61
	0	0	0	0	0	0	0	0	0	0	0	0	0	0	1	1	1	1	B62
	BLUE	0	0	0	0	0	0	0	0	0	0	0	0	1	1	1	1	1	B63

Note

(1) Definition of Gray :

Rn : Red Gray, Gn : Green Gray, Bn : Blue Gray (n = Gray level)

(2) Input Signal : 0 = Low level voltage, 1 = High level voltage

6. INTERFACE TIMING

6.1 Timing Parameters (SYNC&DE mode)

Signal	Item	Symbol	MIN	TYP	MAX	Unit	Note
Clock	Frequency	$1 / T_c$	38.0	40.0	42.0	MHz	
	High Time	T_{CH}	4	-	-	nsec	
	Low Time	T_{CL}	10	-	-	nsec	
Data	Setup Time	T_{DS}	5	-	-	nsec	
	Hold Time	T_{DH}	10	-	-	nsec	
Data Enable	Setup Time	T_{ES}	5	-	-	nsec	(1)
Horizontal Sync	Cycle	T_H	24.0	26.4	31.5	usec	
			1024	1056	1056	clocks	
	Pulse Width	T_{HP}	-	128	-	clocks	
Vertical Sync	Cycle	T_V	620	628	664	lines	
	Pulse Width	T_{VP}	-	4	-	lines	
Horizontal Signal	Display Start	T_{HS}	-	216	-	clocks	
	Display period	T_{HD}	-	800	-	clocks	
Vertical Signal	Display Start	T_{VS}	-	23	-	lines	
	Display Period	T_{VD}	-	600	-	lines	
Hsync - Vsync Phase Difference	Front	T_{VHD}	-320	-	1000	nsec	

Note (1) The duration of DE [DTMG] signal must be longer than 1 clock period at every horizontal sync. period

6.2 Timing diagrams of interface signal

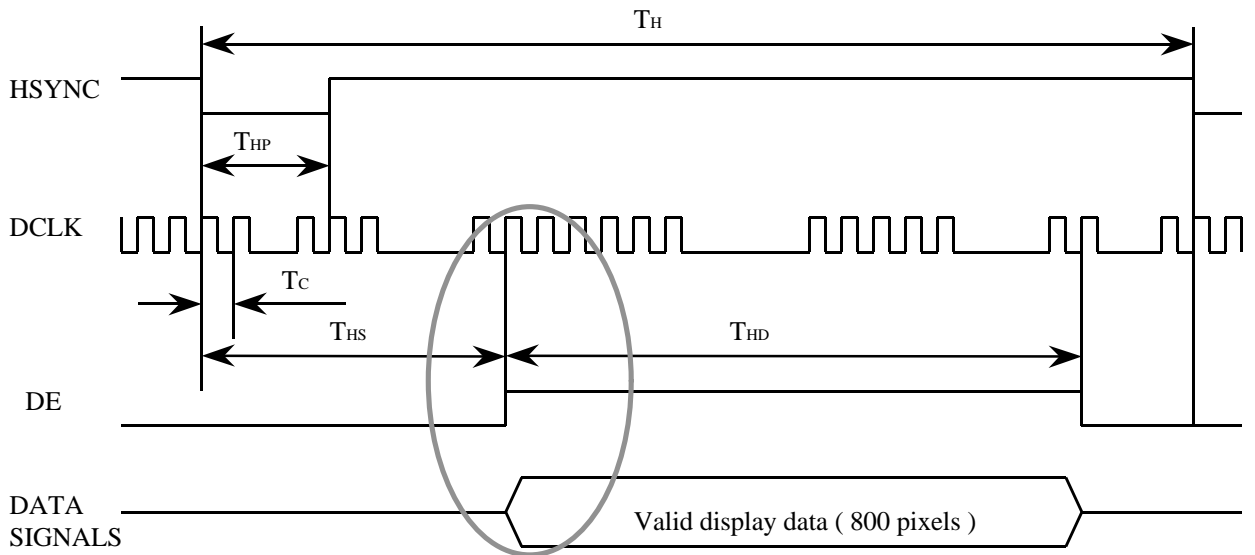
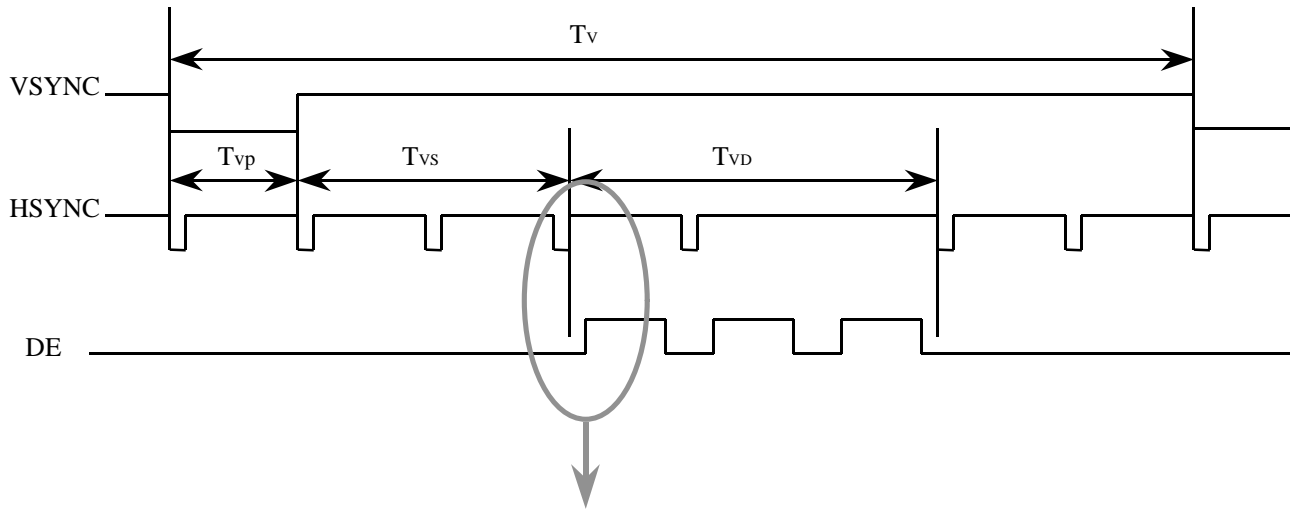

- Signal Transition Timing

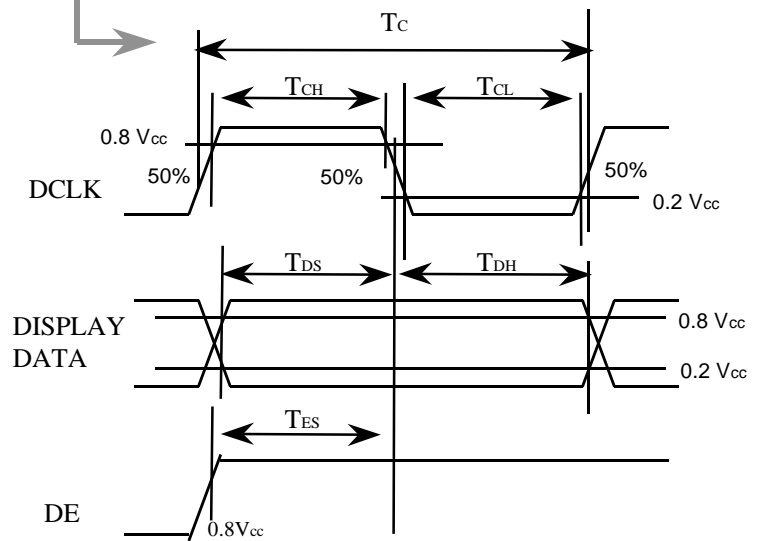
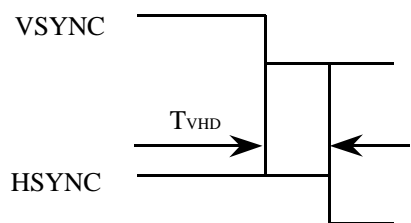

6.3 Power ON/OFF Sequence

: To prevent a latch-up or DC operation of the LCD module, the power on/off sequence should be as the diagram below.

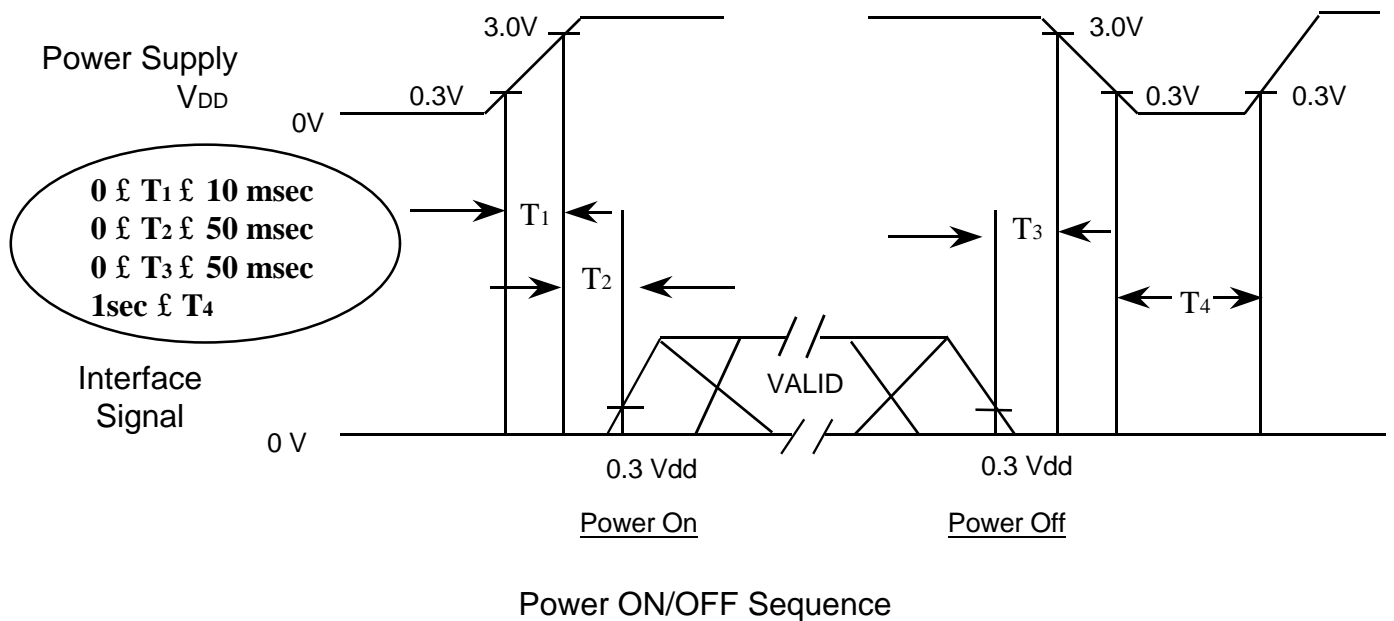

NOTE.

- (1) The supply voltage of the external system for the module input should be the same as the definition of V_{DD} .
- (2) Apply the lamp voltage within the LCD operation range. When the backlight turns on before the LCD operation or the LCD turns off before the backlight turns off, the display may momentarily become white.
- (3) In case of $V_{DD} = \text{off level}$, please keep the level of input signals on the low or keep a high impedance.
- (4) T_4 should be measured after the module has been fully discharged between power off and on period.
- (5) Interface signal shall not be kept at high impedance when the power is on.

7. Outline Dimension

Approval

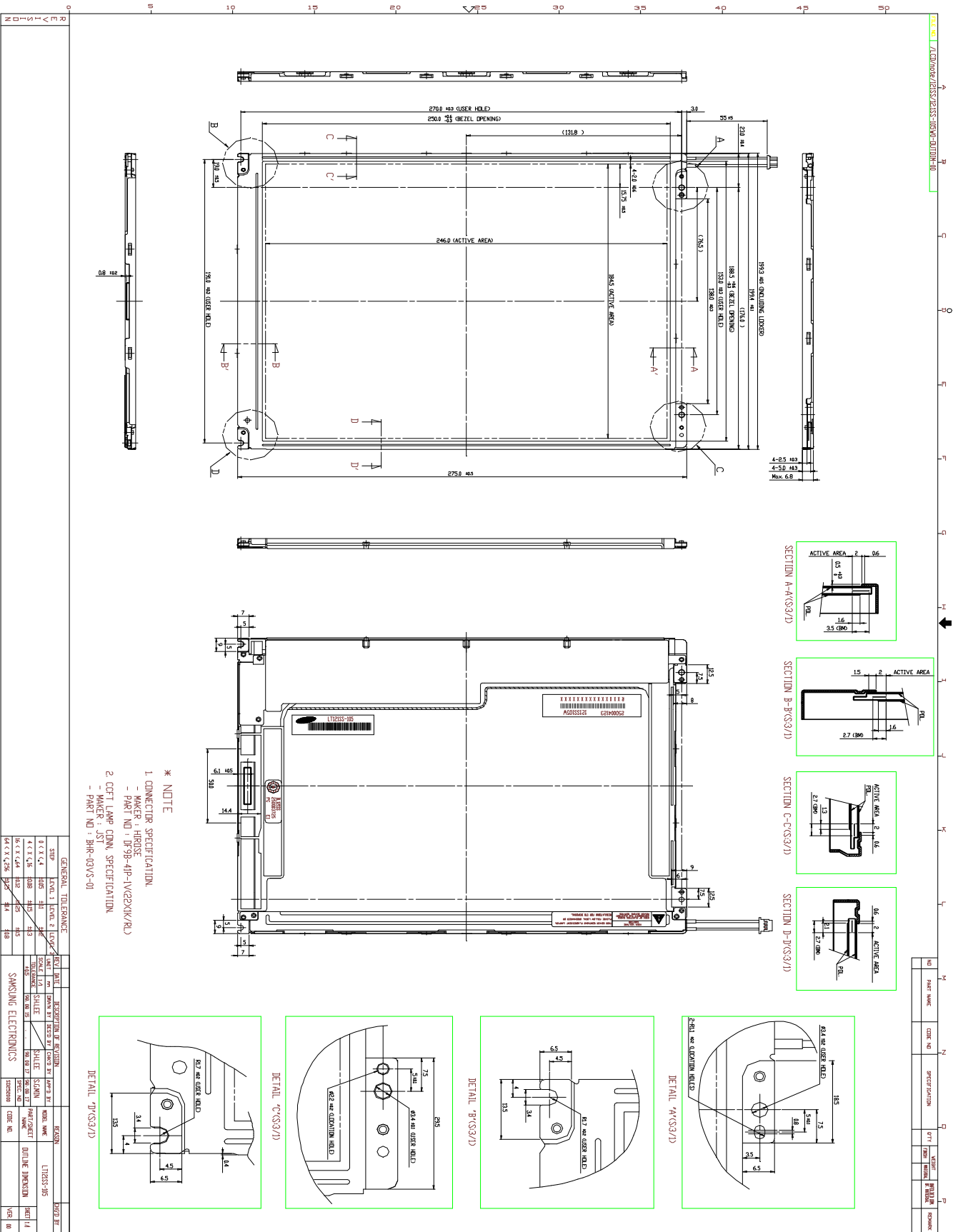

* NOTE
 1. CONNECTOR SPECIFICATION
 - MAKER : HIRSE
 - PART NO : DP98-4P-1V22XK/R/L
 2. CCT LAMP CONN. SPECIFICATION
 - MAKER : JST
 - PART NO : BHR-03VS-01

GENERAL TOLERANCE		REVISION	
FORM	ISO 1	NO.	DATE
SIZE	A	1	2024.01.15
SCALE	1:1	2	2024.01.15
UNIT	MM	3	2024.01.15
DECIMAL	0.05	4	2024.01.15
ANGLE	0.1	5	2024.01.15
CONTOUR	0.2	6	2024.01.15
TEXT	0.5	7	2024.01.15
DRY	0.1	8	2024.01.15
DRY	0.1	9	2024.01.15
DRY	0.1	10	2024.01.15

SAMSUNG ELECTRONICS		REASON	
NO.	DATE	NO.	DATE
1	2024.01.15	1	2024.01.15
2	2024.01.15	2	2024.01.15
3	2024.01.15	3	2024.01.15
4	2024.01.15	4	2024.01.15
5	2024.01.15	5	2024.01.15
6	2024.01.15	6	2024.01.15
7	2024.01.15	7	2024.01.15
8	2024.01.15	8	2024.01.15
9	2024.01.15	9	2024.01.15
10	2024.01.15	10	2024.01.15

8. GENERAL PRECAUTIONS

Approval

1. Handling

- (a) When the module is assembled, It should be attached to the system firmly using every mounting holes. Be careful not to twist and bend the modules.
- (b) Refrain from strong mechanical shock and/or any force to the module. In addition to damage, this may improper operation or damage to the module and CCFL backlight.
- (c) Note that polarizers are very fragile and could be easily damaged. Do not press or scratch the surface harder than a HB pencil lead.
- (d) Wipe off water droplets or oil immediately. If you the droplets for a long time, Staining and discoloration may occur.
- (e) If the surface of the polarizer is dirty, clean it using some absorbent cotton or soft cloth.
- (f) The desirable cleaners are water, IPA(Iso Propyl Alcohol) or Hexane. Do not use Keton type materials(ex. Acetone), Ethyl alcohol, Toluene, Ethyl acid or Methyl chloride. It might permanently damage the polarizer due to chemical reaction.
- (g) If the liquid crystal material leaks from the panel, it should be kept away from the eyes or mouth . In case of contact with hands, legs or clothes, it must be washed away throughly with soap.
- (h) Protect the module from static , it may cause damage to the C-MOS Gate Array IC.
- (i) Use fingerstalls with soft gloves in order to keep display clean during the incoming inspection and assembly process.
- (j) Do not disassemble the module.
- (k) Do not pull or fold the Lamp wire.
- (l) Do not adjust the variable resistor which is located on the back side.

2. STORAGE

- (a) Do not leave the module in high temperature, AND high humidity for a long time.
It is highly recommended to store the module with temperature is from 0 to 35 °C and Relative humidity of less than 70%.
- (b) Do not store the TFT-LCD module in direct sunlight.

3. OPERATION

- (a) Do not connect,disconnect the module in the “ Power On” condition.
- (b) Power supply should always be turned on/off by following item 6.3
“ Power on/off sequence “

4. OTHERS

- (a) Ultra-violet ray filter is necessary for outdoor operation.
- (b) Avoid condensation of water. It may result in improper operation or disconnection of electrode.
- (c) Do not exceed the absolute maximum rating value. (the supply voltage variation, input voltage variation, variation in part contents and environmental temperature, so on)
Otherwise the module may be damaged.
- (d) If the module Displays the same pattern continuously for a long period of time,it can be the situation when the image “sticks” to the screen.