

Low Cost Dual and Triple 130MHz Current Feedback Amplifiers with Shutdown

FEATURES

- 90MHz Bandwidth on $\pm 5V$
- 0.1dB Gain Flatness $>30MHz$
- Completely Off in Shutdown, $0\mu A$ Supply Current
- High Slew Rate: $1600V/\mu s$
- Wide Supply Range: $\pm 2V(4V)$ to $\pm 15V(30V)$
- 60mA Output Current
- Low Supply Current: 5mA/Amplifier
- Differential Gain: 0.016%
- Differential Phase: 0.075°
- Fast Turn-On Time: 100ns
- Fast Turn-Off Time: 40ns
- 14-Pin and 16-Pin Narrow SO Packages

APPLICATIONS

- RGB Cable Drivers
- Spread Spectrum Amplifiers
- MUX Amplifiers
- Composite Video Cable Drivers
- Portable Equipment

DESCRIPTION

The LT[®]1259 contains two independent 130MHz current feedback amplifiers, each with a shutdown pin. These amplifiers are designed for excellent linearity while driving cables and other low impedance loads. The LT1260 is a triple version especially suited to RGB video applications. These amplifiers operate on all supplies from single 5V to $\pm 15V$ and draw only 5mA per amplifier when active.

When shut down, the LT1259/LT1260 amplifiers draw zero supply current and their outputs become high impedance. Only two LT1260s are required to make a complete 2-input RGB MUX and cable driver. These amplifiers turn on in only 100ns and turn off in 40ns, making them ideal in spread spectrum and portable equipment applications.

The LT1259/LT1260 amplifiers are manufactured on Linear Technology's proprietary complementary bipolar process.

 LTC and LT are registered trademarks of Linear Technology Corporation.

TYPICAL APPLICATION

2-Input Video MUX Cable Driver

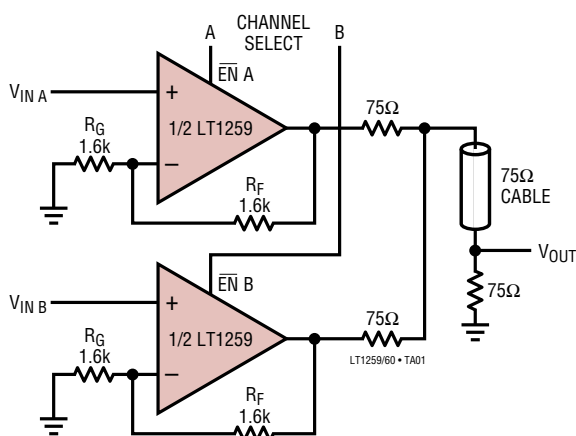

Square Wave Response

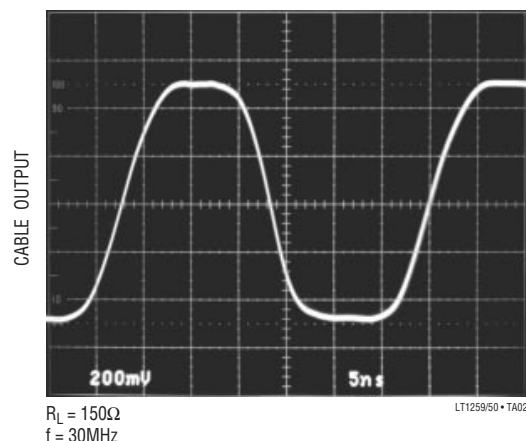

ABSOLUTE MAXIMUM RATINGS

Supply Voltage	±18V	Operating Temperature Range	-40°C to 85°C
Input Current	±15mA	Storage Temperature Range	-65°C to 150°C
Output Short-Circuit Duration (Note 1)	Continuous	Junction Temperature (Note 4)	150°C
Specified Temperature Range (Note 2)	0°C to 70°C	Lead Temperature (Soldering, 10 sec)	300°C

PACKAGE/ORDER INFORMATION

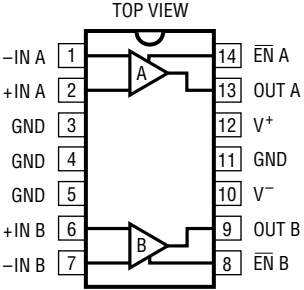
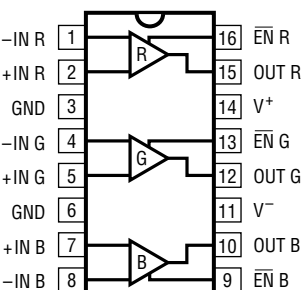
 <p>N PACKAGE 14-LEAD PLASTIC DIP</p> <p>S PACKAGE 14-LEAD PLASTIC SOIC</p> <p>$T_{JMAX} = 150^{\circ}C, \theta_{JA} = 70^{\circ}C/W$ (N) $T_{JMAX} = 150^{\circ}C, \theta_{JA} = 110^{\circ}C/W$ (S)</p>	<p>ORDER PART NUMBER</p> <p>LT1259CN LT1259CS LT1259IN LT1259IS</p>	 <p>N PACKAGE 16-LEAD PLASTIC DIP</p> <p>S PACKAGE 16-LEAD PLASTIC SOIC</p> <p>$T_{JMAX} = 150^{\circ}C, \theta_{JA} = 70^{\circ}C/W$ (N) $T_{JMAX} = 150^{\circ}C, \theta_{JA} = 100^{\circ}C/W$ (S)</p>	<p>ORDER PART NUMBER</p> <p>LT1260CN LT1260CS LT1260IN LT1260IS</p>
--	---	---	---

Consult factory for Military grade parts.

ELECTRICAL CHARACTERISTICS

0°C ≤ T_A ≤ 70°C, each amplifier V_{CM} = 0V, ±5V ≤ V_S ≤ ±15V, EN pins = 0V, pulse tested, unless otherwise noted.

SYMBOL	PARAMETER	CONDITIONS	MIN	TYP	MAX	UNITS
V _{OS}	Input Offset Voltage	T _A = 25°C	●	2	12	mV
			●		16	mV
	Input Offset Voltage Drift		●	30		μV/°C
I _{IN} ⁺	Noninverting Input Current	T _A = 25°C	●	0.5	3	μA
I _{IN} ⁻	Inverting Input Current	T _A = 25°C	●		6	μA
			●	20	90	120
e _n	Input Noise Voltage Density	f = 1kHz, R _F = 1k, R _G = 10Ω, R _S = 0Ω		3.6		nV/√Hz
+i _n	Noninverting Input Noise Current Density	f = 1kHz		1.3		pA/√Hz
-i _n	Inverting Input Noise Current Density	f = 1kHz		45		pA/√Hz
R _{IN}	Input Resistance	V _{IN} = ±13V, V _S = ±15V	●	2	17	MΩ
		V _{IN} = ±3V, V _S = ±5V	●	2	25	MΩ
C _{IN}	Input Capacitance	Enabled		2		pF
		Disabled		4		pF
C _{OUT}	Output Capacitance	Disabled		4.4		pF
V _{IN}	Input Voltage Range	V _S = ±15V, T _A = 25°C	●	±13	±13.5	V
			●	±12		V
		V _S = ±5V, T _A = 25°C	●	±3	±3.5	V
			●	±2		V

ELECTRICAL CHARACTERISTICS

0°C ≤ T_A ≤ 70°C, each amplifier V_{CM} = 0V, ±5V ≤ V_S ≤ ±15V, \overline{EN} pins = 0V, pulse tested, unless otherwise noted.

SYMBOL	PARAMETER	CONDITIONS	MIN	TYP	MAX	UNITS
V _{OUT}	Maximum Output Voltage Swing	V _S = ±15V, R _L = 1k	● ±12.0	±14.0		V
		V _S = ±5V, R _L = 150Ω, T _A = 25°C	● ±3.0	±3.7		V
			● ±2.5			V
CMRR	Common-Mode Rejection Ratio	V _S = ±15V, V _{CM} = ±13V, T _A = 25°C	● 55	69		dB
		V _S = ±15V, V _{CM} = ±12V	● 55			dB
		V _S = ±5V, V _{CM} = ±3V, T _A = 25°C	● 52	63		dB
		V _S = ±5V, V _{CM} = ±2V	● 52			dB
	Inverting Input Current Common-Mode Rejection	V _S = ±15V, V _{CM} = ±13V, T _A = 25°C	●	3.5	10	μA/V
		V _S = ±15V, V _{CM} = ±12V	●		10	μA/V
		V _S = ±5V, V _{CM} = ±3V, T _A = 25°C	●	4.5	15	μA/V
		V _S = ±5V, V _{CM} = ±2V	●		15	μA/V
PSRR	Power Supply Rejection Ratio	V _S = ±2V to ±15V, \overline{EN} Pins at V ⁻ , T _A = 25°C	● 60	80		dB
		V _S = ±3V to ±15V, \overline{EN} Pins at V ⁻	● 60			dB
	Noninverting Input Current Power Supply Rejection	V _S = ±3V to ±15V, \overline{EN} Pins at V ⁻ , T _A = 25°C	●	15	65	nA/V
		V _S = ±3V to ±15V, \overline{EN} Pins at V ⁻	●		75	nA/V
	Inverting Input Current Power Supply Rejection	V _S = ±2V to ±15V, \overline{EN} Pins at V ⁻ , T _A = 25°C	●	0.1	5	μA/V
		V _S = ±3V to ±15V, \overline{EN} Pins at V ⁻	●		5	μA/V
A _V	Large-Signal Voltage Gain	V _S = ±15V, V _{OUT} = ±10V, R _L = 1k	● 57	72		dB
		V _S = ±5V, V _{OUT} = ±2V, R _L = 150Ω	● 57	69		dB
R _{OL}	Transresistance, ΔV _{OUT} /ΔI _{IN} ⁻	V _S = ±15V, V _{OUT} = ±10V, R _L = 1k	● 120	300		kΩ
		V _S = ±5V, V _{OUT} = ±2V, R _L = 150Ω	● 100	200		kΩ
I _{OUT}	Maximum Output Current	R _L = 0Ω, T _A = 25°C		30	60	mA
I _S	Supply Current per Amplifier (Note 5)	V _S = ±15V, V _{OUT} = 0V, T _A = 25°C	●	5.0	7.5	mA
		V _S = ±5V, V _{OUT} = 0V, T _A = 25°C	●	4.5	6.7	mA
	Disable Supply Current per Amplifier	V _S = ±15V, \overline{EN} Pin Voltage = 14.5V, R _L = 150Ω	● 3		16.7	μA
		V _S = ±15V, Sink 1μA From \overline{EN} Pin	● 1		2.7	μA
	Enable Pin Current	V _S = ±15V, \overline{EN} Pin Voltage = 0V, T _A = 25°C	●	60	200	μA
					300	μA
SR	Slew Rate (Note 6)	T _A = 25°C		900	1600	V/μs
t _{ON}	Turn-On Delay Time (Note 7)	A _V = 10, T _A = 25°C		100	400	ns
t _{OFF}	Turn-Off Delay Time (Note 7)	A _V = 10, T _A = 25°C		40	150	ns
t _r , t _f	Small-Signal Rise and Fall Time	V _S = ±12V, R _F = R _G = 1.5k, R _L = 150Ω		4.2		ns
	Propagation Delay	V _S = ±12V, R _F = R _G = 1.5k, R _L = 150Ω		4.7		ns
	Small-Signal Overshoot	V _S = ±12V, R _F = R _G = 1.5k, R _L = 150Ω		5		%
t _S	Settling Time	0.1%, V _{OUT} = 10V, R _F = R _G = 1.5k, R _L = 1k		75		ns
	Differential Gain (Note 8)	V _S = ±12V, R _F = R _G = 1.5k, R _L = 150Ω		0.016		%
	Differential Phase (Note 8)	V _S = ±12V, R _F = R _G = 1.5k, R _L = 150Ω		0.075		DEG

-40°C ≤ T_A ≤ 85°C, each amplifier V_{CM} = 0V, ±5V ≤ V_S ≤ ±15V, \overline{EN} pins = 0V, pulse tested, unless otherwise noted.

SYMBOL	PARAMETER	CONDITIONS	MIN	TYP	MAX	UNITS
V _{OS}	Input Offset Voltage		●		18	mV
I _{IN} ⁺	Noninverting Input Current		●		7	μA
I _{IN} ⁻	Inverting Input Current		●		130	μA
R _{IN}	Input Resistance	V _{IN} = ±3V, V _S = ±5V	●	1		MΩ
A _V	Large-Signal Gain		●	55		dB
I _S	Disable Supply Current per Amplifier	V _S = ±15V, \overline{EN} Pin Voltage = 14.5V, R _L = 150Ω	●		19	μA
	Enable Pin Current	V _S = ±15V, \overline{EN} Pin Voltage = 0V	●		350	μA

ELECTRICAL CHARACTERISTICS

The ● denotes specifications which apply over the specified operating temperature range.

Note 1: A heat sink may be required depending on the power supply voltage and how many amplifiers have their outputs short circuited.

Note 2: Commercial grade parts are designed to operate over the temperature range of -40°C to 85°C but are neither tested nor guaranteed beyond 0°C to 70°C . Industrial grade parts specified and tested over -40°C to 85°C are available on special request. Consult factory.

Note 3: Ground pins are not internally connected. For best performance, connect to ground.

Note 4: T_J is calculated from the ambient temperature T_A and the power dissipation P_D according to the following formulas:

$$\begin{aligned} \text{LT1259CN/LT1259IN: } T_J &= T_A + (P_D \cdot 70^{\circ}\text{C/W}) \\ \text{LT1259CS/LT1259IS: } T_J &= T_A + (P_D \cdot 110^{\circ}\text{C/W}) \\ \text{LT1260CN/LT1260IN: } T_J &= T_A + (P_D \cdot 70^{\circ}\text{C/W}) \\ \text{LT1260CS/LT1260IS: } T_J &= T_A + (P_D \cdot 100^{\circ}\text{C/W}) \end{aligned}$$

Note 5: The supply current of the LT1259/LT1260 has a negative temperature coefficient. See Typical Performance Characteristics.

Note 6: Slew rate is measured at $\pm 5\text{V}$ on a $\pm 10\text{V}$ output signal while operating on $\pm 15\text{V}$ supplies with $R_F = 1\text{k}$, $R_G = 110\Omega$ and $R_L = 1\text{k}$.

Note 7: Turn-on delay time is measured while operating on $\pm 5\text{V}$ supplies with $R_F = 1\text{k}$, $R_G = 110\Omega$ and $R_L = 150\Omega$. The t_{ON} is measured from control input to appearance of 0.5V at the output, for $V_{IN} = 0.1\text{V}$. Likewise, turn-off delay time is measured from control input to appearance of 0.5V on the output for $V_{IN} = 0.1\text{V}$.

Note 8: Differential gain and phase are measured using a Tektronix TSG120YC/NTSC signal generator and a Tektronix 1780R Video Measurement Set. The resolution of this equipment is 0.1% and 0.1° . Six identical amplifier stages were cascaded giving an effective resolution of 0.016% and 0.016° .

TYPICAL AC PERFORMANCE

V_S (V)	A_V	R_L (Ω)	R_F (Ω)	R_G (Ω)	SMALL SIGNAL -3dB BW (MHz)	SMALL SIGNAL 0.1dB BW (MHz)	SMALL SIGNAL PEAKING (dB)
± 12	2	150	1.5k	1.5k	130	53	0.1
± 5	2	150	1.1k	1.1k	93	40	0
± 12	10	150	1.1k	121	69	20	0.13
± 5	10	150	825	90.9	61	16	0

TYPICAL PERFORMANCE CHARACTERISTICS

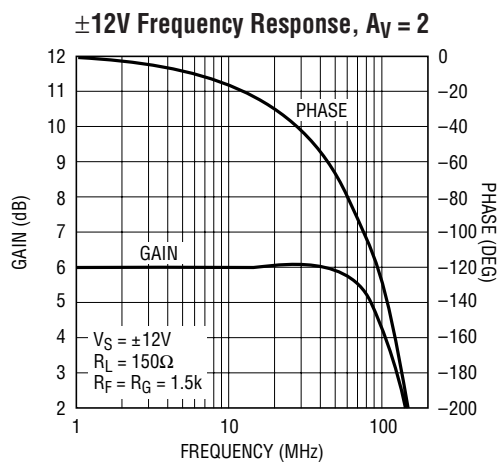

LT1259/60 • TPC01

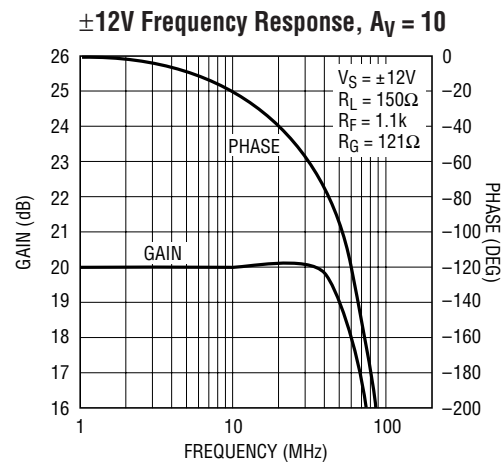

LT1259/60 • TPC01

TYPICAL PERFORMANCE CHARACTERISTICS

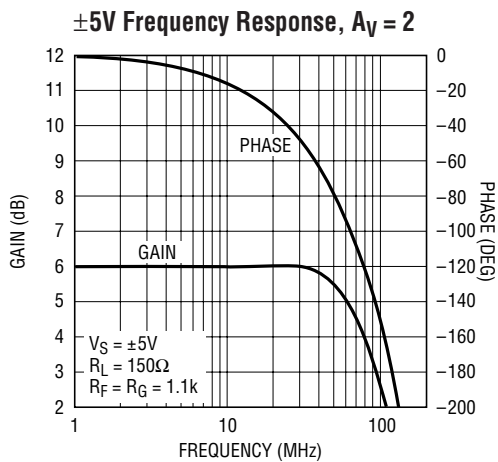

LT1259/60 • TPC03

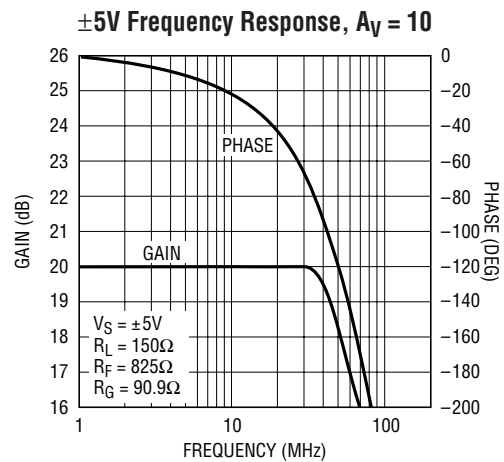

LT1259/60 • TPC04

Total Harmonic Distortion vs Frequency

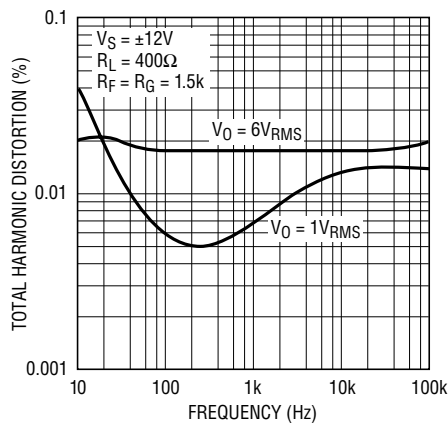

LT1259/60 • TPC05

2nd and 3rd Harmonic Distortion vs Frequency

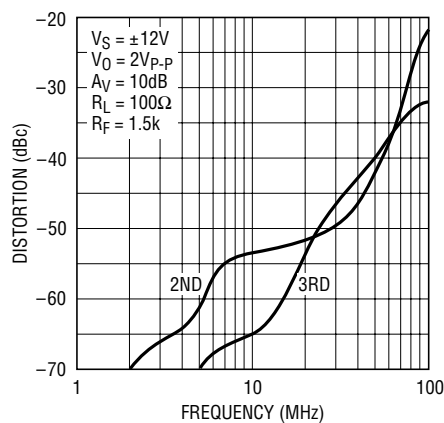

LT12359/60 • TPC06

Maximum Undistorted Output vs Frequency

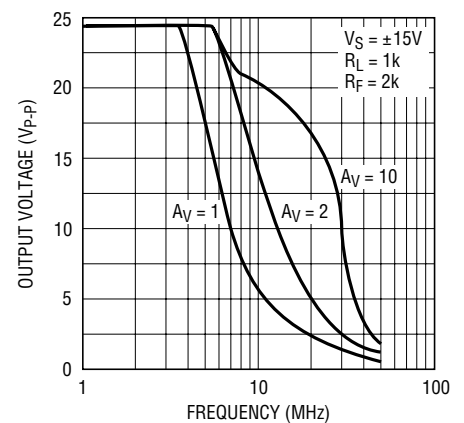

LT12359/60 • TPC07

Power Supply Rejection vs Frequency

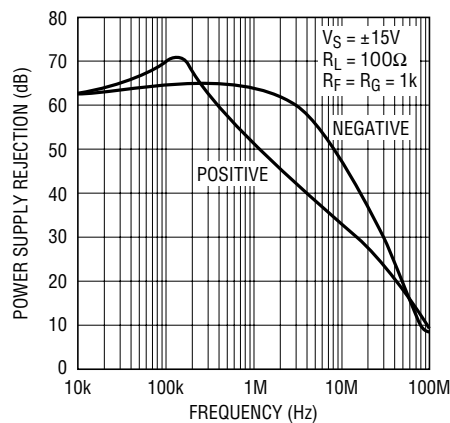

LT1259/60 • TPC08

Spot Noise Voltage and Current vs Frequency

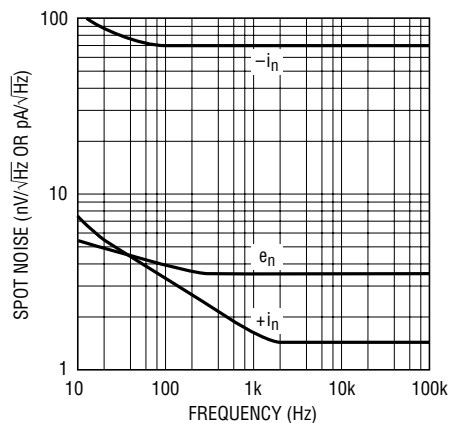

LT1259/60 • TPC09

Output Impedance vs Frequency

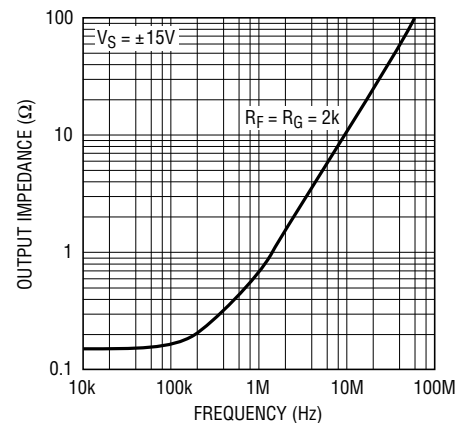

LT1259/60 • TPC10

TYPICAL PERFORMANCE CHARACTERISTICS

Output Impedance in Shutdown vs Frequency

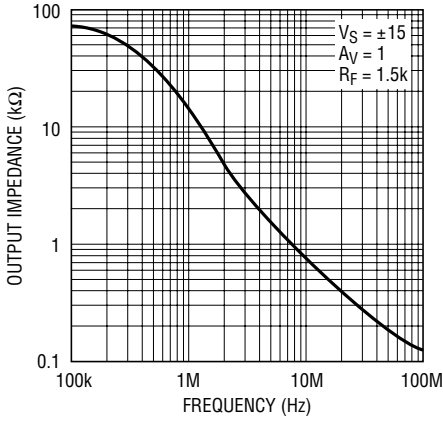

LT1259/60 • TPC11

Maximum Capacitive Load vs Feedback Resistor

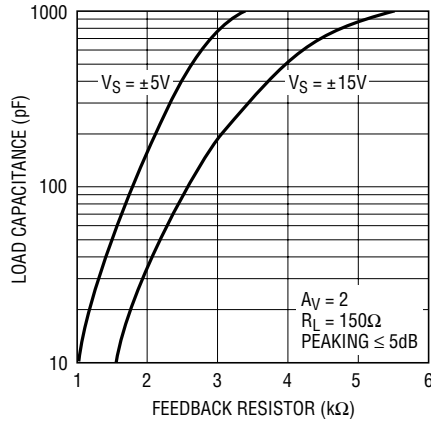

LT1259/60 • TPC12

Supply Current vs Supply Voltage

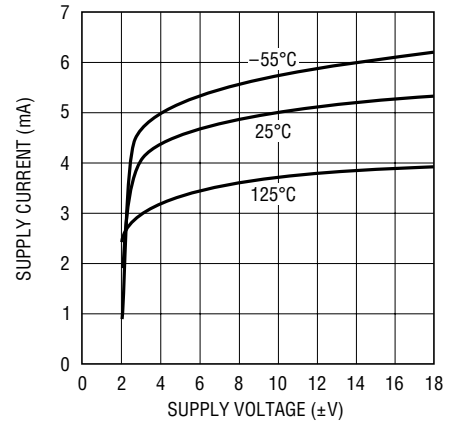

LT1259/60 • TPC13

Output Saturation Voltage vs Temperature

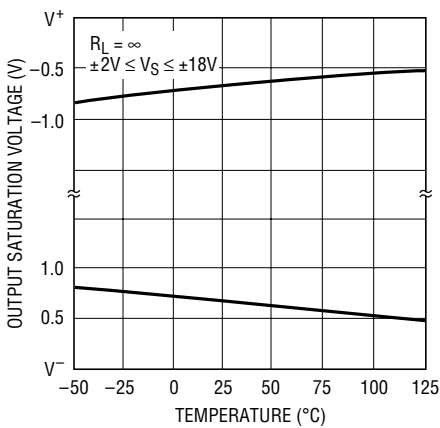

LT1259/60 • TPC14

Input Common-Mode Limit vs Temperature

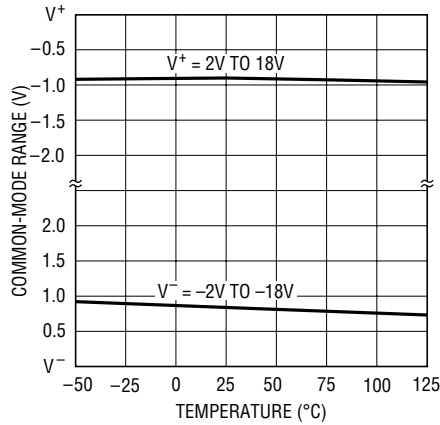

LT1259/60 • TPC16

Output Short-Circuit Current vs Junction Temperature

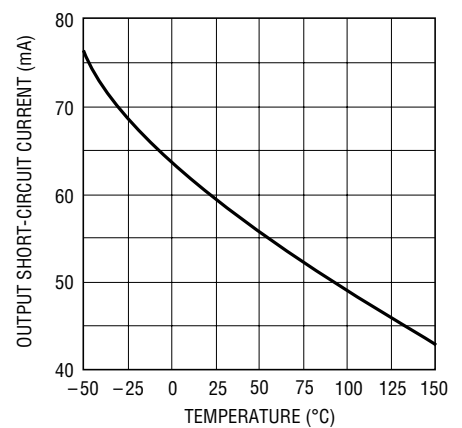

LT1259/60 • TPC15

Settling Time to 10mV vs Output Step

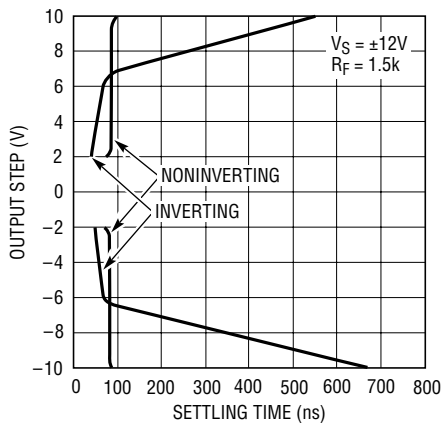

LT1259/60 • TPC17

Small-Signal Rise Time

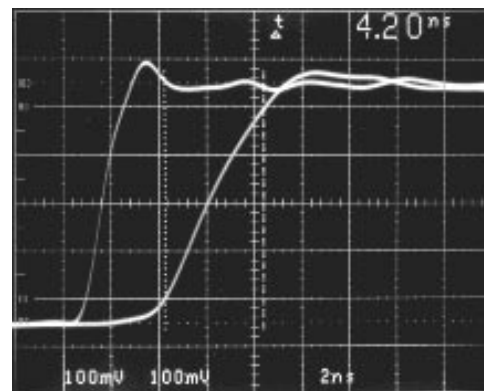

$V_S = \pm 15V$ $R_F = R_G = 1.6k$
 $A_V = 2$ $R_L = 150\Omega$

LT1259/60 G19

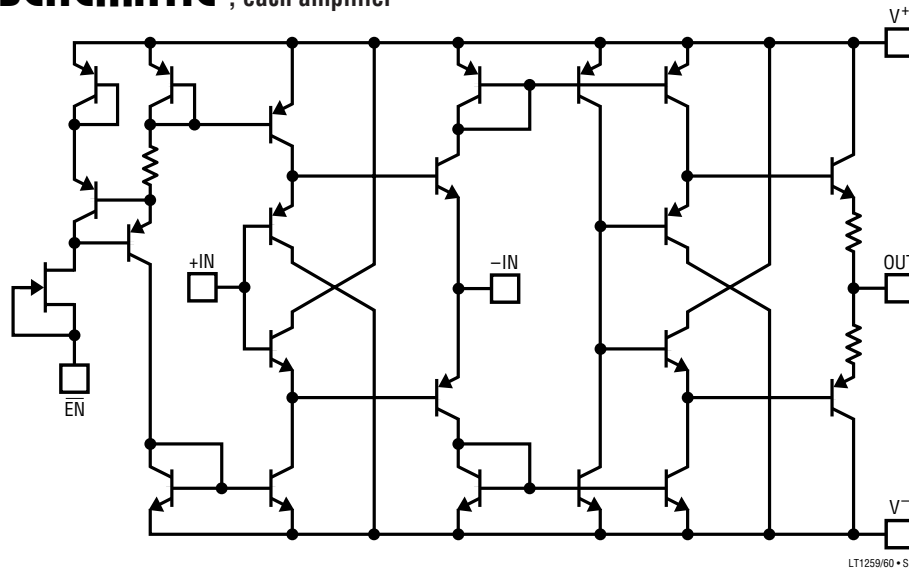
SIMPLIFIED SCHEMATIC, each amplifier**APPLICATIONS INFORMATION****Feedback Resistor Selection**

The small-signal bandwidth of the LT1259/LT1260 are set by the external feedback resistors and the internal junction capacitors. As a result, the bandwidth is a function of the supply voltage, the value of the feedback resistor, the closed-loop gain and the load resistor. The LT1259/LT1260 have been optimized for $\pm 5\text{V}$ supply operation and have a -3dB bandwidth of 90MHz . See resistor selection guide in Typical AC Performance table.

Capacitance on the Inverting Input

Current feedback amplifiers require resistive feedback from the output to the inverting input for stable operation. Take care to minimize the stray capacitance between the output and the inverting input. Capacitance on the inverting input to ground will cause peaking in the frequency response (and overshoot in the transient response). See the section on Demo Board Information.

Capacitive Loads

The LT1259/LT1260 can drive capacitive loads directly when the proper value of feedback resistor is used. The graph of Maximum Capacitive Load vs Feedback Resistor should be used to select the appropriate value. The value shown is for $\leq 5\text{dB}$ peaking when driving a 150Ω load at a gain of 2. This is a worst case condition. The amplifier is

more stable at higher gains. Alternatively, a small resistor (10Ω to 20Ω) can be put in series with the output to isolate the capacitive load from the amplifier output. This has the advantage that the amplifier bandwidth is only reduced when the capacitive load is present. The disadvantage is that the gain is a function of the load resistance.

Power Supplies

The LT1259/LT1260 will operate from single or split supplies from $\pm 2\text{V}$ (4V total) to $\pm 15\text{V}$ (30V total). It is not necessary to use equal value split supplies, however the offset voltage and inverting input bias current will change. The offset voltage changes about $500\mu\text{V}$ per volt of supply mismatch. The inverting bias current can change as much as $5\mu\text{A}$ per volt of supply mismatch though typically, the change is about $0.1\mu\text{A}$ per volt.

Slew Rate

The slew rate of a current feedback amplifier is not independent of the amplifier gain configuration the way slew rate is in a traditional op amp. This is because both the input stage and the output stage have slew rate limitations. In the inverting mode, and for higher gains in the noninverting mode, the signal amplitude between the input pins is small and the overall slew rate is that of the output stage. For gains less than ten in the noninverting mode, the overall slew rate is limited by the input stage.

APPLICATIONS INFORMATION

The input slew rate of the LT1259/LT1260 is approximately 270V/ μ s and is set by internal currents and capacitances. The output slew rate is set by the value of the feedback resistors and internal capacitances. At a gain of 10 with at 1k feedback resistor and \pm 15V supplies, the output slew rate is typically 1600V/ μ s. Larger feedback resistors will reduce the slew rate as will lower supply voltages, similar to the way the bandwidth is reduced.

The graph of Maximum Undistorted Output vs Frequency relates the slew rate limitations to sinusoidal input for various gains.

looks like a 4.4pF capacitor in parallel with a 75k resistor, excluding feedback resistor effects. These amplifiers are designed to operate with open drain logic: the $\overline{\text{EN}}$ pins have internal pullups and the amplifiers draw zero current when these pins are high. To activate an amplifier, its $\overline{\text{EN}}$ pin is pulled to ground (or at least 2V below the positive supply). The enable pin current is approximately 60 μ A when activated. Input referred switching transients with no input signal applied are only 35mV positive and 80mV negative with $R_L = 100\Omega$.

Large-Signal Transient Response, $A_V = 2$

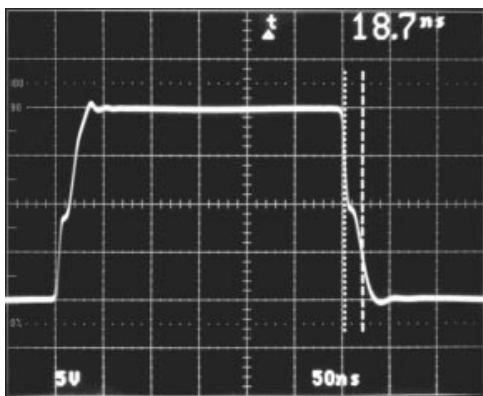

$V_S = \pm 15V$ $R_L = 400\Omega$
 $R_F = R_G = 1.6k$ LT1259/LT1260 • A101

Large-Signal Transient Response, $A_V = 10$

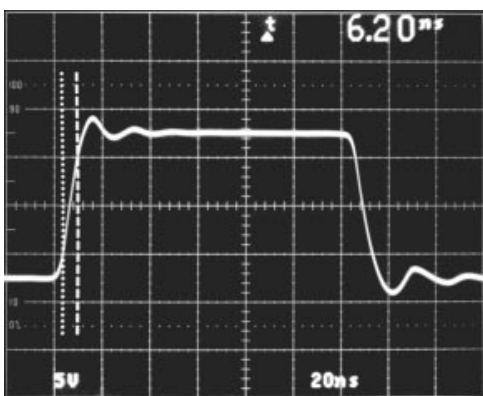

$V_S = \pm 15V$ $R_G = 110\Omega$
 $R_F = 1k$ $R_L = 400\Omega$ LT1259/LT1260 • A102

Enable/Disable

The LT1259/LT1260 amplifiers have a unique high impedance, zero supply current mode which is controlled by independent $\overline{\text{EN}}$ pins. When disabled, an amplifier output

Output Switching Transient

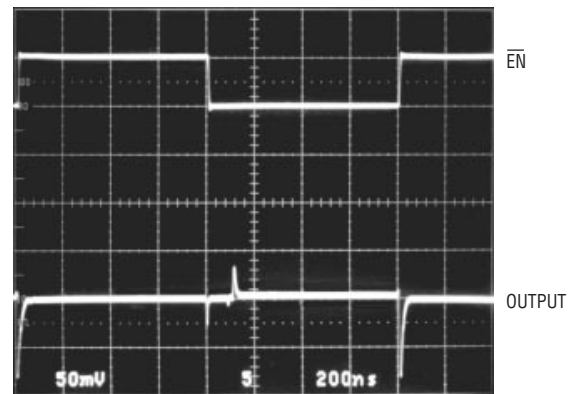

$V_S = \pm 5V$ $R_F = R_G = 1.6k$
 $V_{IN} = 0V$ $R_L = 100\Omega$ LT1259/LT1260 • A103

The enable/disable times are very fast when driven from standard 5V logic. The amplifier enables in about 100ns (50% point to 50% point) while operating on \pm 5V supplies. Likewise the disable time is approximately 40ns (50% point to 50% point) or 75ns to 90% of the final value. The output decay time is set by the output capacitance and load resistor.

Amplifier Enable Time, $A_V = 10$

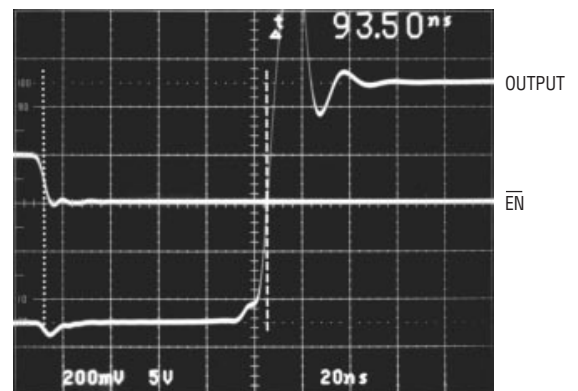

$V_S = \pm 5V$ $R_F = 1k$ $R_L = 150\Omega$
 $V_{IN} = 0.1V$ $R_G = 110\Omega$ LT1259/LT1260 • A104

APPLICATIONS INFORMATION

Amplifier Disable Time, $A_V = 10$

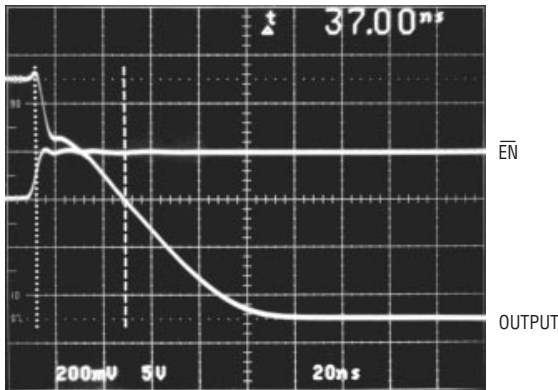

$V_S = \pm 5V$ $R_F = 1k$ $R_L = 150\Omega$ LT1259/LT1260 • A105
 $V_{IN} = 0.1V$ $R_G = 110\Omega$

Amplifier Enable/Disable Time, $A_V = 2$

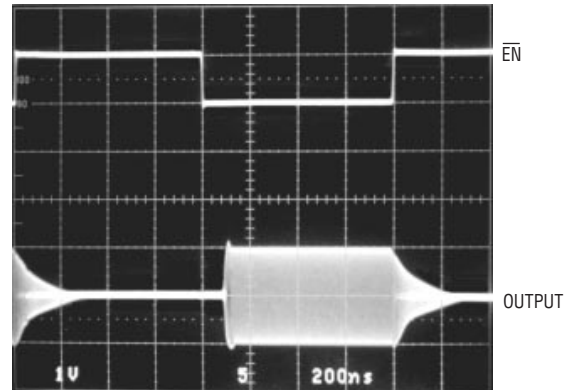

$V_S = \pm 5V$ $R_F = R_G = 1.6k$ LT1259/LT1260 • A106
 $V_{IN} = 2V_{PP}$ at 2MHz $R_L = 100\Omega$

Differential Input Signal Swing

The differential input swing is limited to about $\pm 6V$ by an ESD protection device connected between the inputs. In normal operation, the differential voltage between the

input pins is small, so this clamp has no effect. In the disabled mode however, the differential swing can be the same as the input swing, and the clamp voltage will set the maximum allowable input voltage.

TYPICAL APPLICATIONS

2-Input Video MUX Cable Driver

The application on the first page shows a low cost, 2-input video MUX cable driver. The scope photo displays the cable output of a 30MHz square wave driving 150Ω . In this circuit the active amplifier is loaded by R_F and R_G of the disabled amplifier, but in this case it only causes a 1.2% gain error. The gain error can be eliminated by

configuring each amplifier as a unity-gain follower. The switching time between channels is 100ns when both $\overline{EN} A$ and $\overline{EN} B$ are driven.

2-Input Video MUX Switching Response

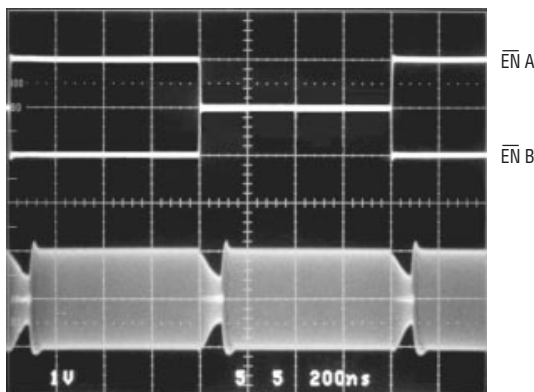

$V_S = \pm 5V$ $R_F = R_G = 1.6k$ LT1259/LT1260 • TA03
 $V_{IN A} = V_{IN 2} = 2V_{PP}$ at 2MHz $R_L = 100\Omega$

2-Input RGB MUX Cable Driver Demonstration Board

A complete 2-input RGB MUX has been fabricated on PC Demo Board #039A. The board incorporates two LT1260s with outputs summed through 75Ω back termination resistors as shown in the schematic. There are several things to note about Demo Board #039A:

1. The feedback resistors of the disabled LT1260 load the enabled amplifier and cause a small (1% to 2%) gain error depending on the values of R_F and R_G . Configure the amplifiers as unity-gain followers to eliminate this error.
2. The feedback node has minimum trace length connecting R_F and R_G to minimize stray capacitance.
3. Ground plane is pulled away from R_F and R_G on both sides of the board to minimize stray capacitance.

TYPICAL APPLICATIONS

4. Capacitors C1 and C6 are optional and only needed to reduce overshoot when $\overline{EN} 1$ or $\overline{EN} 2$ are activated with a long inductive ground wire.
5. The R, G and B amplifiers have slightly different frequency responses due to different output trace routing to R_F (between pins 3 and 4). All amplifiers have slightly less bandwidth in PCB #039 than when measured alone as shown in the Typical AC Performance table.
6. Part-to-part variation can change the peaking by $\pm 0.25\text{dB}$.

RGB Demo Board All Hostile Crosstalk

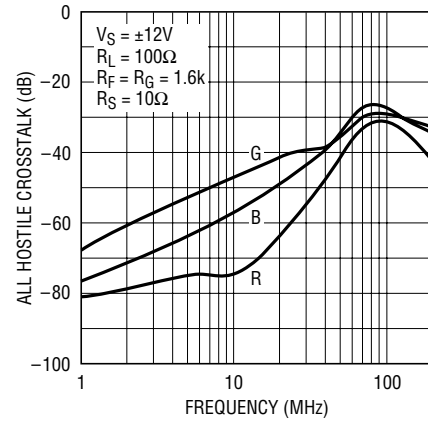

LT1259/60 • TA06

RGB Demo Board Gain vs Frequency

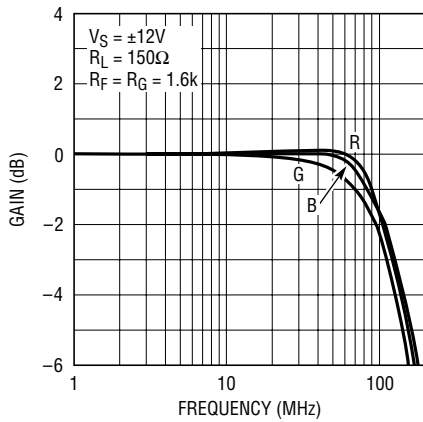

LT1259/60 • TA04

RGB Demo Board Gain vs Frequency

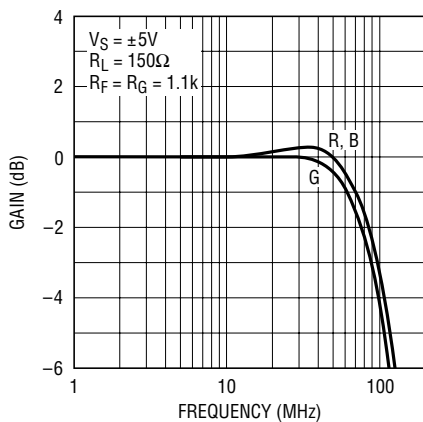

LT1259/60 • TA05

P-DIP PC Board #039

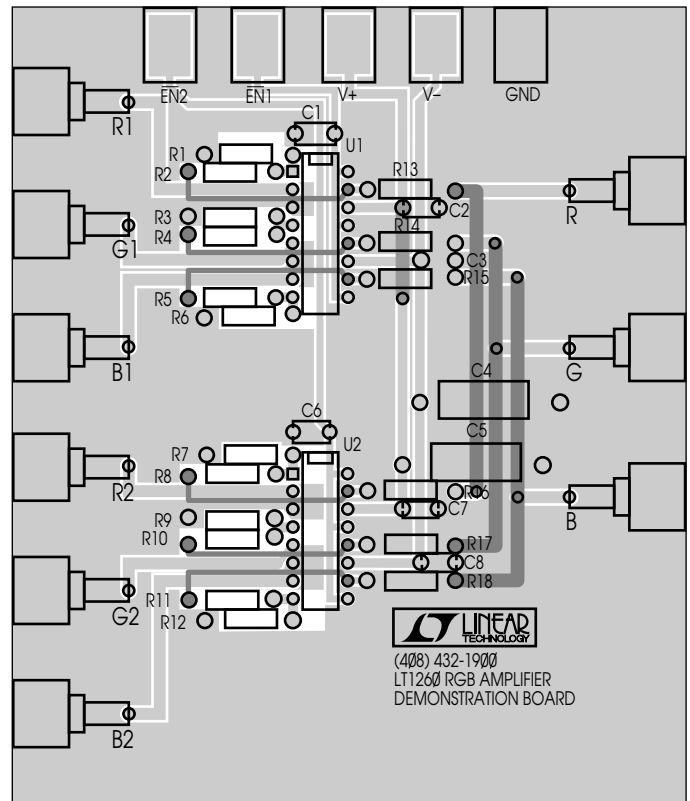

LT1259/60 • TA07

PACKAGE DESCRIPTION

Dimensions in inches (millimeters) unless otherwise noted.

**N Package
14-Lead PDIP (Narrow 0.300)**
(LTC DWG # 05-08-1510)

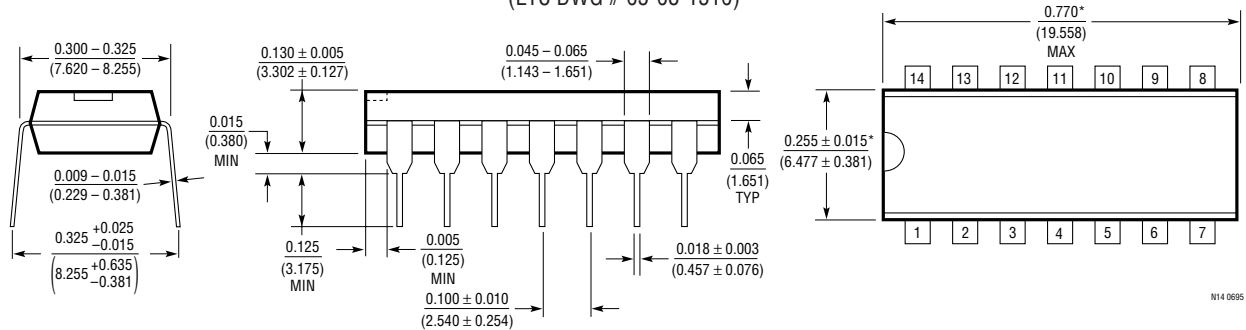

*THESE DIMENSIONS DO NOT INCLUDE MOLD FLASH OR PROTRUSIONS.
MOLD FLASH OR PROTRUSIONS SHALL NOT EXCEED 0.010 INCH (0.254mm)

**N Package
16-Lead PDIP (Narrow 0.300)**
(LTC DWG # 05-08-1510)

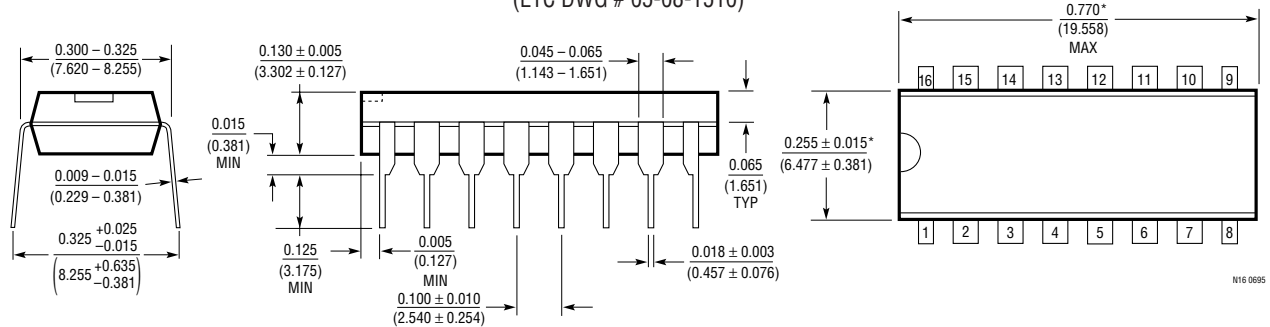

*THESE DIMENSIONS DO NOT INCLUDE MOLD FLASH OR PROTRUSIONS.
MOLD FLASH OR PROTRUSIONS SHALL NOT EXCEED 0.010 INCH (0.254mm)

**S Package
14-Lead Plastic Small Outline (Narrow 0.150)**
(LTC DWG # 05-08-1610)

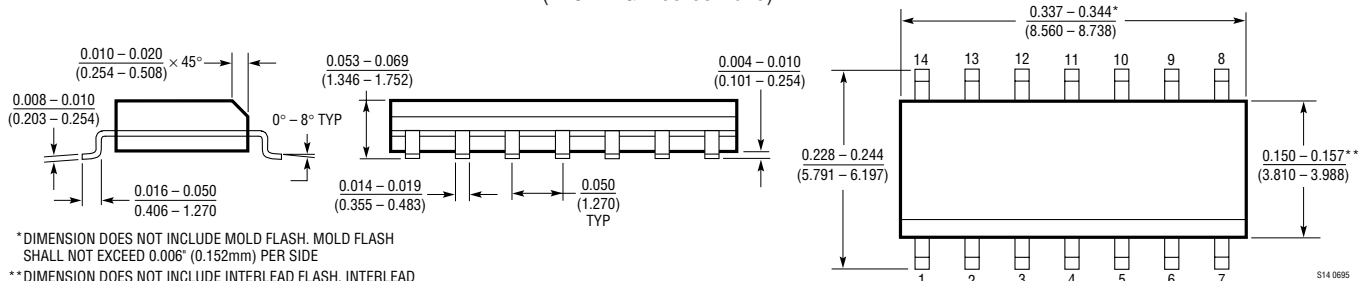

* DIMENSION DOES NOT INCLUDE MOLD FLASH. MOLD FLASH SHALL NOT EXCEED 0.006" (0.152mm) PER SIDE
** DIMENSION DOES NOT INCLUDE INTERLEAD FLASH. INTERLEAD FLASH SHALL NOT EXCEED 0.010" (0.254mm) PER SIDE

**S Package
16-Lead Plastic Small Outline (Narrow 0.150)**
(LTC DWG # 05-08-1610)

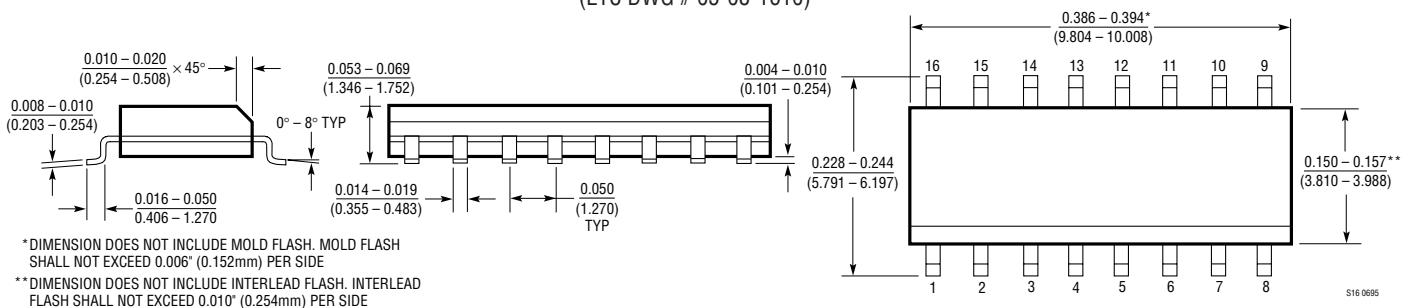

* DIMENSION DOES NOT INCLUDE MOLD FLASH. MOLD FLASH SHALL NOT EXCEED 0.006" (0.152mm) PER SIDE
** DIMENSION DOES NOT INCLUDE INTERLEAD FLASH. INTERLEAD FLASH SHALL NOT EXCEED 0.010" (0.254mm) PER SIDE

TYPICAL APPLICATION

Demonstration PC Board Schematic #039

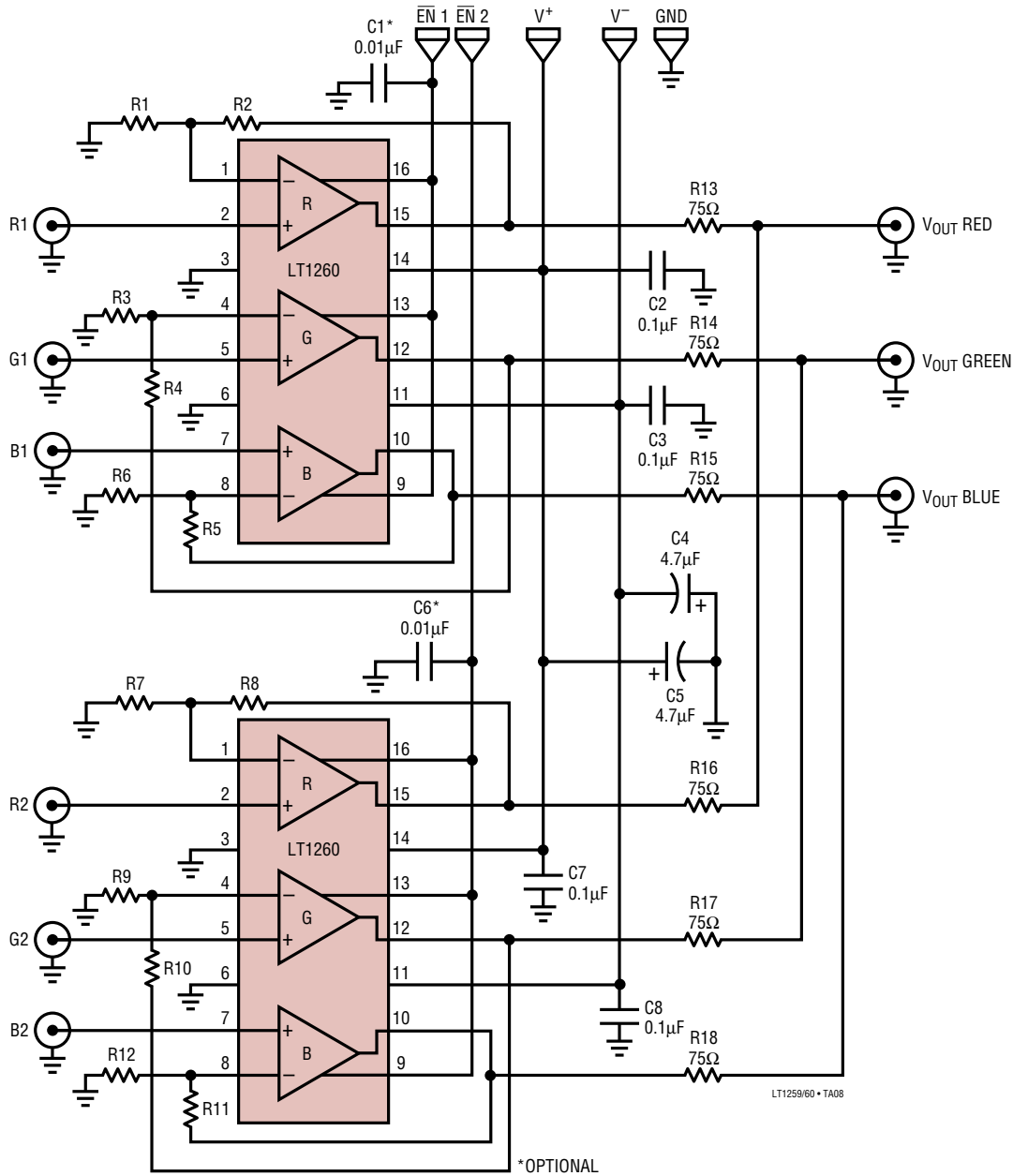

RELATED PARTS

PART NUMBER	DESCRIPTION	COMMENTS
LT1203/LT1205	150MHz Video Multiplexers	2:1 and Dual 2:1 MUXes with 25ns Switch Time
LT1204	4-Input Video MUX with Current Feedback Amplifier	Cascadable Enable 64:1 Multiplexing
LT1227	140MHz Current Feedback Amplifier	1100V/μs Slew Rate, Shutdown Mode
LT1252/LT1253/LT1254	Low Cost Video Amplifiers	Single, Dual and Quad Current Feedback Amplifiers