

Slew Rate Controlled Ultralow Noise DC/DC Controller

FEATURES

- Greatly Reduced Conducted and Radiated EMI
- Low Switching Harmonic Content
- Independent Control of Output Switch Voltage and Current Slew Rates
- Greatly Reduced Need for External Filters
- Single N-Channel MOSFET Driver
- 20kHz to 250kHz Oscillator Frequency
- Easily Synchronized to External Clock
- Regulates Positive and Negative Voltages
- Easier Layout Than with Conventional Switchers

APPLICATIONS

- Power Supplies for Noise Sensitive Communication Equipment
- EMI Compliant Offline Power Supplies
- Precision Instrumentation Systems
- Isolated Supplies for Industrial Automation
- Medical Instruments
- Data Acquisition Systems

DESCRIPTION

The LT[®]1738 is a switching regulator controller designed to lower conducted and radiated electromagnetic interference (EMI). Ultralow noise and EMI are achieved by controlling the voltage and current slew rates of an external N-channel MOSFET switch. Current and voltage slew rates can be independently set to optimize harmonic content of the switching waveforms vs efficiency. The LT1738 can reduce high frequency harmonic power by as much as 40dB with only minor losses in efficiency.

The LT1738 utilizes a current mode architecture optimized for single switch topologies such as boost, flyback and Cuk. The IC includes gate drive and all necessary oscillator, control and protection circuitry. Unique error amp circuitry can regulate both positive and negative voltages. The internal oscillator may be synchronized to an external clock for more accurate placement of switching harmonics.

Protection features include gate drive lockout for low V_{IN} , soft-start, output current limit, short-circuit current limiting, gate drive overvoltage clamp and input supply undervoltage lockout.

LT, LTC and LT are registered trademarks of Linear Technology Corporation.

TYPICAL APPLICATION

Ultralow Noise 5V to 12V Converter

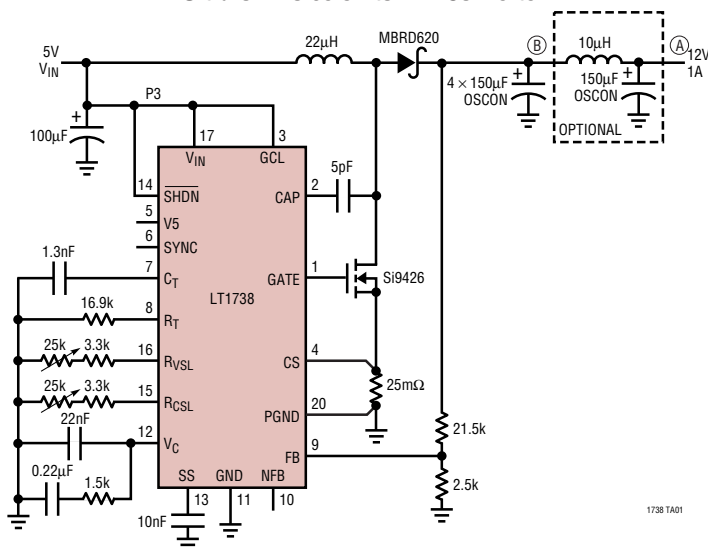

12V Output Noise
(Bandwidth = 100MHz)

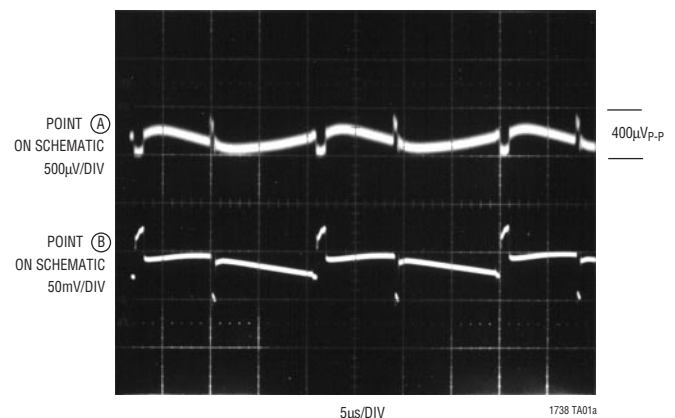

ABSOLUTE MAXIMUM RATINGS

(Note 1)

Supply Voltage (V_{IN})	20V
Gate Drive Current	Internal Limit
V5 Current	Internal Limit
SHDN Pin Voltage	20V
Feedback Pin Voltage (Trans. 10ms)	$\pm 10V$
Feedback Pin Current	10mA
Negative Feedback Pin Voltage (Trans. 10ms)	$\pm 10V$
CS Pin	5V
GCL Pin	16V
SS Pin	3V
Operating Junction Temperature Range	
(Note 3)	$-40^{\circ}C$ to $125^{\circ}C$
Storage Temperature Range	$-65^{\circ}C$ to $150^{\circ}C$
Lead Temperature (Soldering, 10 sec)	$300^{\circ}C$

PACKAGE/ORDER INFORMATION

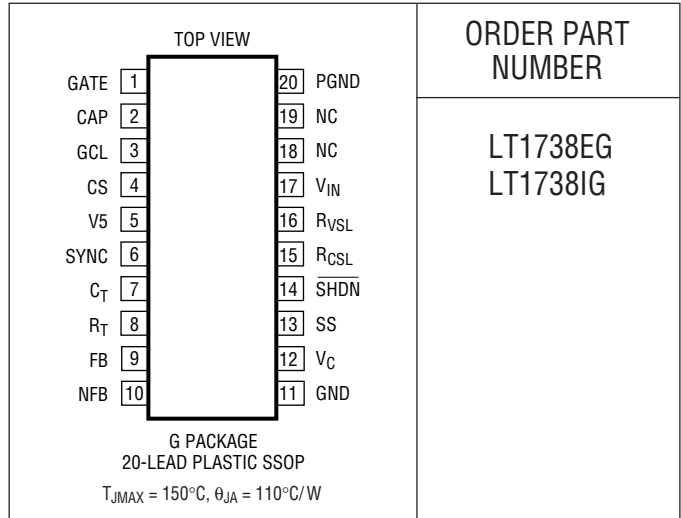

ORDER PART NUMBER

LT1738EG
LT1738IG

Consult LTC Marketing for parts specified with wider operating temperature ranges.

ELECTRICAL CHARACTERISTICS

The ● denotes the specifications which apply over the full operating temperature range, otherwise specifications are at $T_A = 25^{\circ}C$. $V_{IN} = 12V$, $V_C = 0.9V$, $V_{FB} = V_{REF}$, $R_{VSL}, R_{CSL} = 16.9k$, $R_T = 16.9k$ and other pins open unless otherwise noted.

SYMBOL	PARAMETER	CONDITIONS	MIN	TYP	MAX	UNITS
Error Amplifiers						
V_{REF}	Reference Voltage	Measured at Feedback Pin	● 1.235	1.250	1.265	V
I_{FB}	Feedback Input Current	$V_{FB} = V_{REF}$	●	250	1000	nA
FB_{REG}	Reference Voltage Line Regulation	$2.7V \leq V_{IN} \leq 20V$	●	0.012	0.03	%/V
V_{NFR}	Negative Feedback Reference Voltage	Measured at Negative Feedback Pin with Feedback Pin Open	● -2.56	-2.50	-2.45	V
I_{NFR}	Negative Feedback Input Current	$V_{NFB} = V_{NFR}$	●	-37	-25	μA
NFB_{REG}	Negative Feedback Reference Voltage Line Regulation	$2.7V \leq V_{IN} \leq 20V$	●	0.009	0.03	%/V
g_m	Error Amplifier Transconductance	$\Delta I_C = \pm 50\mu A$	● 1100	1500	2200	μmho
			● 700		2500	μmho
I_{ESK}	Error Amp Sink Current	$V_{FB} = V_{REF} + 150mV, V_C = 0.9V$	● 120	200	350	μA
I_{ESRC}	Error Amp Source Current	$V_{FB} = V_{REF} - 150mV, V_C = 0.9V$	● 120	200	350	μA
V_{CLH}	Error Amp Clamp Voltage	High Clamp, $V_{FB} = 1V$		1.27		V
V_{CLL}	Error Amp Clamp Voltage	Low Clamp, $V_{FB} = 1.5V$		0.12		V
A_V	Error Amplifier Voltage Gain		180	250		V/V
FB_{OV}	FB Overvoltage Shutdown	Outputs Drivers Disabled		1.47		V
I_{SS}	Soft-Start Charge Current	$V_{SS} = 1V$		9.0	12	μA

ELECTRICAL CHARACTERISTICS

The ● denotes the specifications which apply over the full operating temperature range, otherwise specifications are at $T_A = 25^\circ\text{C}$. $V_{IN} = 12\text{V}$, $V_C = 0.9\text{V}$, $V_{FB} = V_{REF}$, $R_{VSL} = 16.9\text{k}$, $R_{CSL} = 16.9\text{k}$, $R_T = 16.9\text{k}$ and other pins open unless otherwise noted.

SYMBOL	PARAMETER	CONDITIONS	MIN	TYP	MAX	UNITS	
Oscillator and Sync							
f_{MAX}	Max Switch Frequency			250		kHz	
f_{SYNC}	Synchronization Frequency Range	Oscillator Frequency = 250kHz		290		kHz	
V_{SYNC}	SYNC Pin Input Threshold		● 0.7	1.4	2		
R_{SYNC}	SYNC Pin Input Resistance			40		k Ω	
Gate Drive							
DC_{MAX}	Maximum Switch Duty Cycle	$R_{VSL} = R_{CSL} = 3.9\text{k}$, Osc Frequency = 25kHz	● 90	93.5		%	
V_{GON}	Gate On Voltage	$V_{IN} = 12$, $GCL = 12$ $V_{IN} = 12$, $GCL = 8$		10 7.6	10.4 7.9	10.7 8.1	V V
V_{GOF}	Gate Off Voltage	$V_{IN} = 12\text{V}$		0.2	0.35	V	
I_{GSO}	Max Gate Source Current	$V_{IN} = 12\text{V}$		0.3		A	
I_{GSK}	Max Gate Sink Current	$V_{IN} = 12\text{V}$		0.3		A	
V_{INUVLO}	Gate Drive Undervoltage Lockout (Note 5)	$V_{GCL} = 6.5\text{V}$		7.3	7.5	V	
Current Sense							
t_{IBL}	Switch Current Limit Blanking Time			100		ns	
V_{SENSE}	Sense Voltage Shutdown Voltage	V_C Pulled Low	● 86	103	120	mV	
V_{SENSEF}	Sense Voltage Fault Threshold			220	300	mV	
Slew Control for the Following Slew Tests See Test Circuit in Figure 1b							
V_{SLEWR}	Output Voltage Slew Rising Edge	$R_{VSL} = R_{CSL} = 17\text{k}$		26		V/ μs	
V_{SLEWF}	Output Voltage Slew Falling Edge	$R_{VSL} = R_{CSL} = 17\text{k}$		19		V/ μs	
V_{SLEWR}	Output Current Slew Rising Edge (CS pin V)	$R_{VSL} = R_{CSL} = 17\text{k}$		2.1		V/ μs	
V_{SLEWF}	Output Current Slew Falling Edge (CS pin V)	$R_{VSL} = R_{CSL} = 17\text{k}$		2.1		V/ μs	
Supply and Protection							
V_{INMIN}	Minimum Input Voltage (Note 4)	$V_{GCL} = V_{IN}$	●	2.55	3.6	V	
I_{VIN}	Supply Current (Note 3)	$R_{VSL} = R_{CSL} = 17\text{k}$ $V_{IN} = 12$ $R_{VSL} = R_{CSL} = 17\text{k}$ $V_{IN} = 20$	●	12 35	40 55	mA mA	
V_{SHDN}	Shutdown Turn-On Threshold		● 1.31	1.39	1.48	V	
ΔV_{SHDN}	Shutdown Turn-On Voltage Hysteresis		● 50	110	180	mV	
I_{SHDN}	Shutdown Input Current Hysteresis		● 10	24	35	μA	
V_5	5V Reference Voltage	$6.5\text{V} \leq V_{IN} \leq 20\text{V}$, $I_{V5} = 5\text{mA}$ $6.5\text{V} \leq V_{IN} \leq 20\text{V}$, $I_{V5} = -5\text{mA}$		4.85 4.80	5 5	5.20 5.15	V V
I_{V5SC}	5V Reference Short-Circuit Current	$V_{IN} = 6.5\text{V}$ Source $V_{IN} = 6.5\text{V}$ Sink		10 -10		mA mA	

Note 1: Absolute Maximum Ratings are those values beyond which the life of a device may be impaired.

Note 2: Supply current specification includes loads on each gate as in Figure 1a. Actual supply currents vary with operating frequency, operating voltages, V_5 load, slew rates and type of external FET.

Note 3: The LT1738E is guaranteed to meet performance specifications from 0°C to 70°C . Specifications from -40°C to 125°C are assured by

design, characterization and correlation with statistical process controls. The LT1738I is guaranteed and tested to meet performance specifications from -40°C to 125°C .

Note 4: Output gate drive is enabled at this voltage. The GCL voltage will also determine driver activity.

Note 5: Gate drive is ensured to be on when V_{IN} is greater than max value.

TYPICAL PERFORMANCE CHARACTERISTICS

Feedback Voltage and Input Current vs Temperature

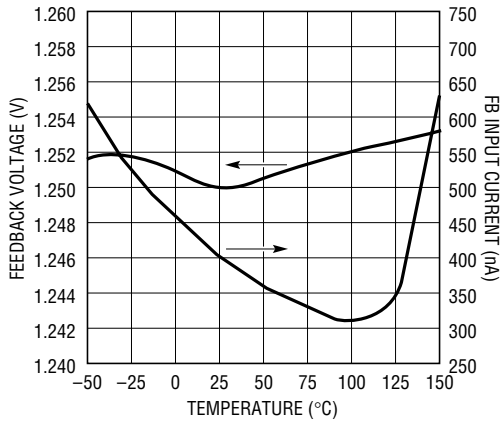

1738 G01

Negative Feedback Voltage and Input Current vs Temperature

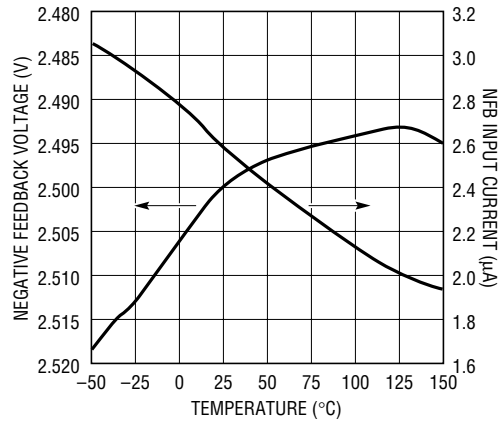

1738 G02

Feedback Overvoltage Shutdown vs Temperature

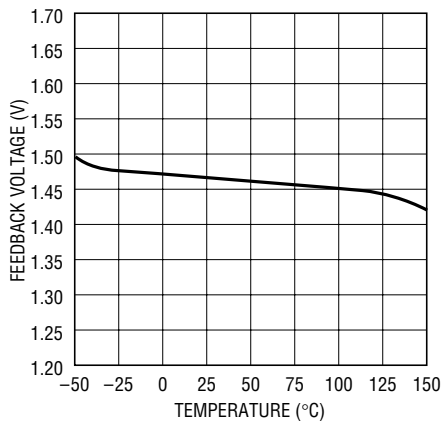

1738 G03

Error Amp Transconductance vs Temperature

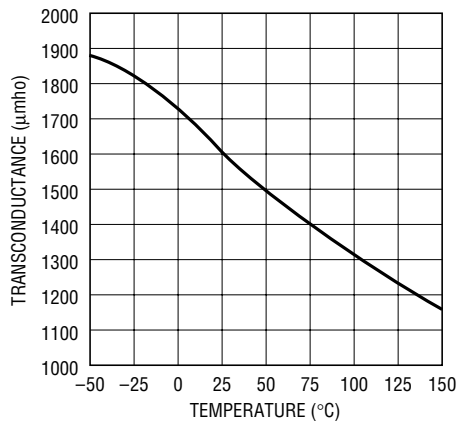

1738 G04

Error Amp Output Current vs Feedback Pin Voltage from Nominal

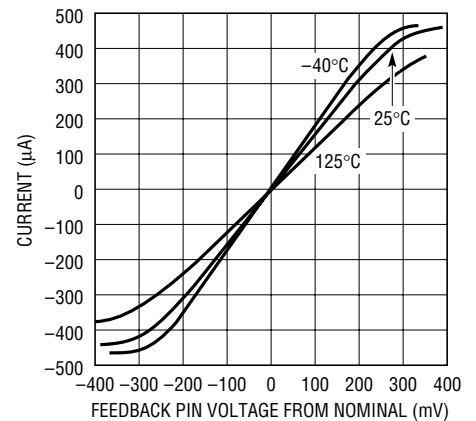

1738 G05

V_C Pin Threshold and Clamp Voltage vs Temperature

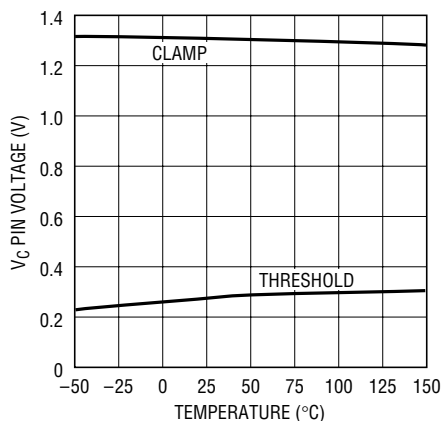

1738 G06

CS Pin Trip Voltage and CS Fault Voltage vs Temperature

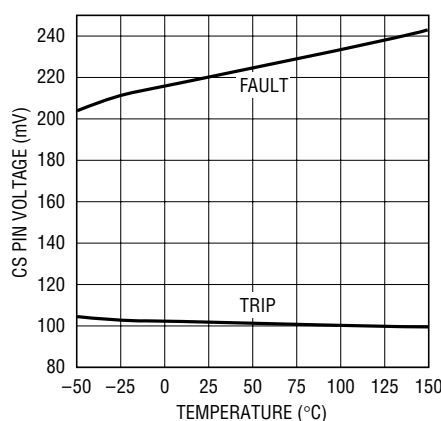

1738 G07

SHDN Pin On and Off Thresholds vs Temperature

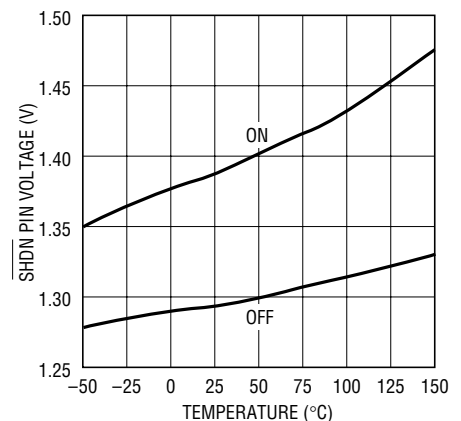

1738 G08

TYPICAL PERFORMANCE CHARACTERISTICS

SHDN Pin Hysteresis Current vs Temperature

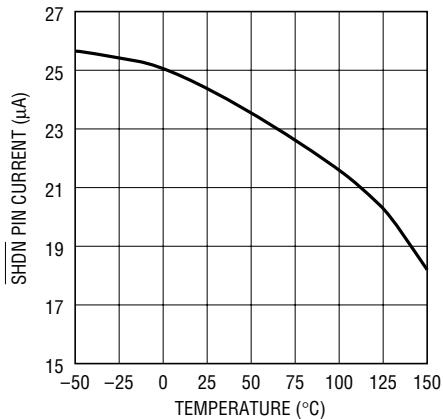

1738 G09

V_{IN} Current vs Temperature

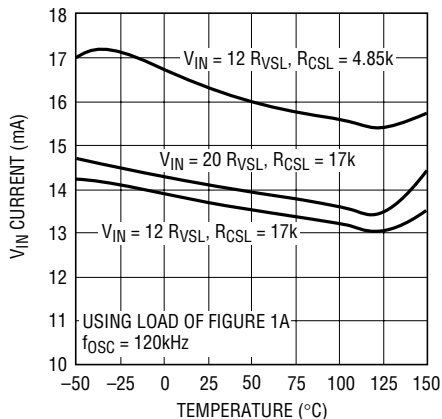

1738 G10

CS Pin to V_C Pin Transfer Function

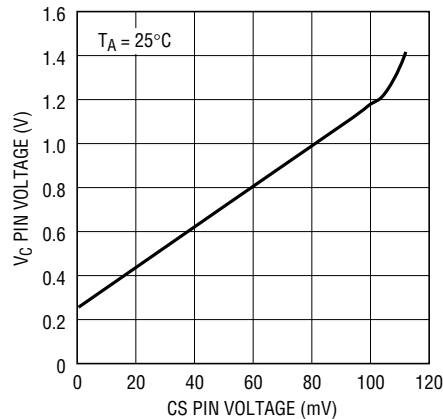

1738 G11

Slope Compensation

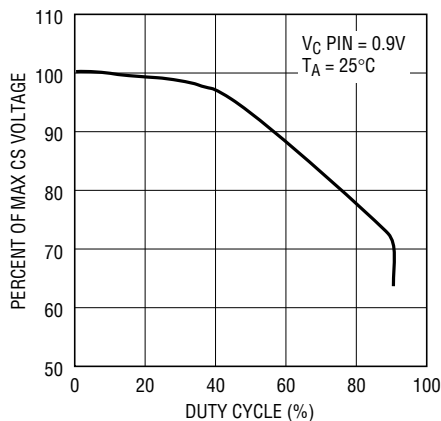

1738 G12

Gate Drive High Voltage vs Temperature

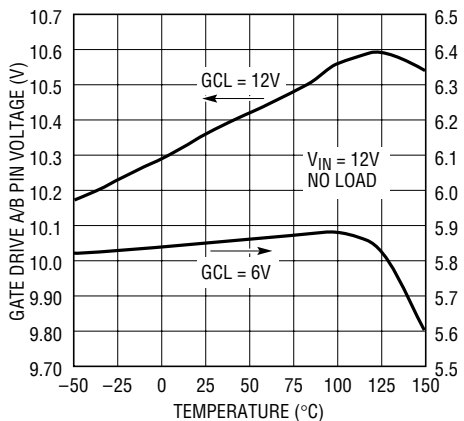

1738 G13

Gate Drive Low Voltage vs Temperature

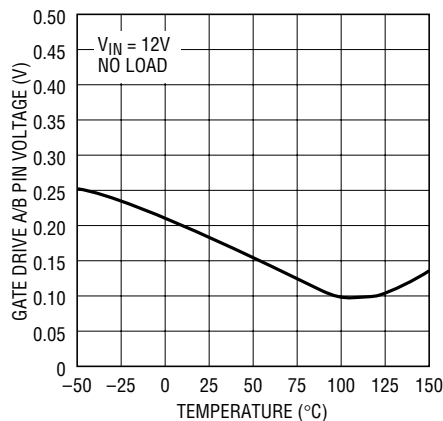

1738 G14

Gate Drive Undervoltage Lockout Voltage vs Temperature

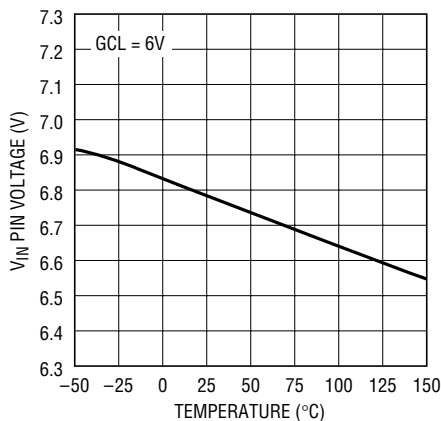

1738 G15

Soft-Start Current vs Temperature

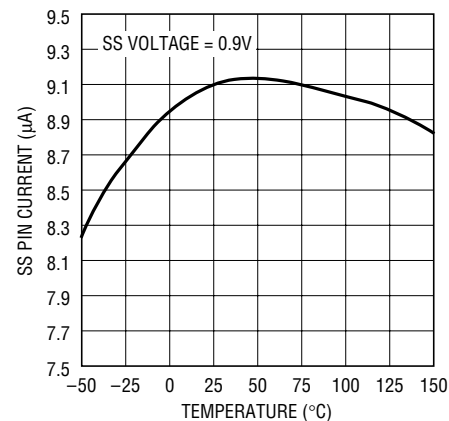

1738 G16

V₅ Voltage vs Load Current

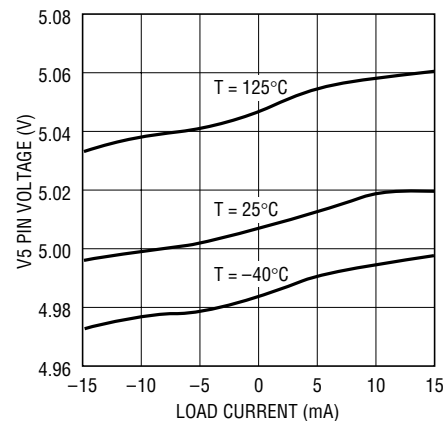

1738 G17

1738fa

PIN FUNCTIONS

Part Supply

V5 (Pin 5): This pin provides a 5V output that can sink or source 10mA for use by external components. V5 source current comes from V_{IN} . Sink current goes to GND. V_{IN} must be greater than 6.5V in order for this voltage to be in regulation. If this pin is used, a small capacitor ($<1\mu\text{F}$) may be placed on this pin to reduce noise. This pin can be left open if not used.

GND (Pin 11): Signal Ground. The internal error amplifier, negative feedback amplifier, oscillator, slew control circuitry, V5 regulator, current sense and the bandgap reference are referred to this ground. Keep the connection to this pin, the feedback divider and V_C compensation network free of large ground currents.

SHDN (Pin 14): The shutdown pin can disable the switcher. Grounding this pin will disable all internal circuitry.

Increasing SHDN voltage will initially turn on the internal bandgap regulator. This provides a precision threshold for the turn on of the rest of the IC. As SHDN increases past 1.39V the internal LDO regulator turns on, enabling the control and logic circuitry.

24 μA of current is sourced out of the pin above the turn on threshold. This can be used to provide hysteresis for the shutdown function. The hysteresis voltage will be set by the Thevenin resistance of the resistor divider driving this pin times the current sourced out. Above approximately 2.1V the hysteresis current is removed. There is approximately 0.1V of voltage hysteresis on this pin as well.

The pin can be tied high (to V_{IN} for instance).

V_{IN} (Pin 17): Input Supply. All supply current for the part comes from this pin including gate drive and V5 regulator. Charge current for gate drive can produce current pulses of hundreds of milliamperes. Bypass this pin with a low ESR capacitor.

When V_{IN} is below 2.55V the part will go into supply undervoltage lockout where the gate driver is driven low. This, along with gate drive undervoltage lockout, prevents unpredictable behavior during power up.

PGND (Pin 20): Power Driver Ground. This ground comes from the MOSFET gate driver. This pin can have several hundred milliamperes of current on it when the external MOSFET is being turned off.

Oscillator

SYNC (Pin 6): The SYNC pin can be used to synchronize the part to an external clock. The oscillator frequency should be set close to the external clock frequency. Synchronizing the clock to an external reference is useful for creating more stable positioning of the switcher voltage and current harmonics. This pin can be left open or tied to ground if not used.

C_T (Pin 7): The oscillator capacitor pin is used in conjunction with R_T to set the oscillator frequency. For $R_T = 16.9\text{k}$:

$$C_{\text{OSC}}(\text{nf}) = 129/f_{\text{OSC}}(\text{kHz})$$

R_T (Pin 8): A resistor to ground sets the charge and discharge currents of the oscillator capacitor. The nominal value is 16.9k. It is possible to adjust this resistance $\pm 25\%$ to set oscillator frequency more accurately.

Gate Drive

GATE (Pin 1): This pin connects to the gate of an external N-channel MOSFET. This driver is capable of sinking and sourcing at least 300mA.

The GCL pin sets the upper voltage of the gate drive. The GATE pin will not be activated until V_{IN} reaches a minimum voltage as defined by the GCL pin (gate undervoltage lockout).

The gate drive output has current limit protection to safeguard against accidental shorts.

GCL (Pin 3): This pin sets the maximum gate voltage to the GATE pin to the MOSFET gate drive. This pin should be either tied to a zener, a voltage source, or V_{IN} .

If the pin is tied to a zener or a voltage source, the maximum gate drive voltage will be approximately $V_{\text{GCL}} - 0.2\text{V}$. If it is tied to V_{IN} , the maximum gate voltage is approximately $V_{IN} - 1.6$.

PIN FUNCTIONS

Approximately 50 μ A of current can be sourced from this pin if $V_{GCL} < V_{IN} - 0.8V$.

This pin also controls undervoltage lockout of the gate drive. If the pin is tied to a zener or voltage source, the gate drive will not be enabled until $V_{IN} > V_{GCL} + 0.8V$. If this pin is tied to V_{IN} , then undervoltage lockout is disabled.

There is an internal 19V zener tied from this pin to ground to provide a fail-safe for maximum gate voltage.

Slew Control

CAP (Pin 2): This pin is the feedback node for the external voltage slewing capacitor. Normally a small 1pf to 5pf capacitor is connected from this pin to the drain of the MOSFET.

The voltage slew rate is inversely proportional to this capacitance and proportional to the current that the part will sink and source on this pin. That current is inversely proportional to R_{VSL} .

R_{CSL} (Pin 15): A resistor to ground sets the current slew rate for the external drive MOSFET during switching. The minimum resistor value is 3.3k and the maximum value is 68k. The time to slew between on and off states of the MOSFET current will determine how the di/dt related harmonics are reduced. This time is proportional to R_{CSL} and R_S (the current sense resistor) and maximum current. Longer times produce a greater reduction of higher frequency harmonics.

R_{VSL} (Pin 16): A resistor to ground sets the voltage slew rate for the drain of the external drive MOSFET. The minimum resistor value is 3.3k and the maximum value is 68k. The time to slew between on and off states on the MOSFET drain voltage will determine how dv/dt related harmonics are reduced. This time is proportional to R_{VSL} , C_V and the input voltage. Longer times produce more rolloff of harmonics. C_V is the equivalent capacitance from CAP to the drain of the MOSFET.

Switch Mode Control

SS (Pin 3): The SS pin allows for ramping of the switch current threshold at startup. Normally a capacitor is placed on this pin to ground. An internal 9 μ A current source will charge this capacitor up. The voltage on the V_C pin cannot

exceed the voltage on SS. Thus peak current will ramp up as the SS pin ramps up. During a short circuit fault the SS pin will be discharged to ground thus reinitializing soft-start.

When SS is below the V_C clamp voltage the V_C pin will closely track the SS pin.

This pin can be left open if not used.

CS (Pin 4): This is the input to the current sense amplifier. It is used for both current mode control and current slewing of the external MOSFET. Current sense is accomplished via a sense resistor (R_S) connected from the source of the external MOSFET to ground. CS is connected to the top of R_S . Current sense is referenced to the GND pin.

The switch maximum operating current will be equal to $0.1V/R_S$. At $CS = 0.1V$, the gate driver will be immediately turned off (no slew control).

If $CS = 0.22V$ in addition to the drivers being turned off, V_C and SS will be discharged to ground (short-circuit protection). This will hasten turn off on subsequent cycles.

FB (Pin 9): The feedback pin is used for positive voltage sensing. It is the inverting input to the error amplifier. The noninverting input of this amplifier connects internally to a 1.25V reference.

If the voltage on this pin exceeds the reference by 220mV, then the output driver will immediately turn off the external MOSFET (no slew control). This provides for output over-voltage protection

When this input is below 0.9V then the current sense blanking will be disabled. This will assist start up.

NFB (Pin 10): The negative feedback pin is used for sensing a negative output voltage. The pin is connected to the inverting input of the negative feedback amplifier through a 100k source resistor. The negative feedback amplifier provides a gain of -0.5 to the FB pin. The nominal regulation point would be $-2.5V$ on NFB. This pin should be left open if not used.

If NFB is being used then overvoltage protection will occur at 0.44V below the NFB regulation point.

At $NFB < -1.8$ current sense blanking will be disabled.

PIN FUNCTIONS

V_C (Pin 12): The compensation pin is used for frequency compensation and current limiting. It is the output of the error amplifier and the input of the current comparator. Loop frequency compensation can be performed with an RC network connected from the V_C pin to ground. The voltage on V_C is proportional to the switch peak current. The normal range of voltage on this pin is 0.25V to 1.27V. However, during slope compensation the upper clamp voltage is allowed to increase with the compensation.

During a short-circuit fault the V_C pin will be discharged to ground.

TEST CIRCUITS

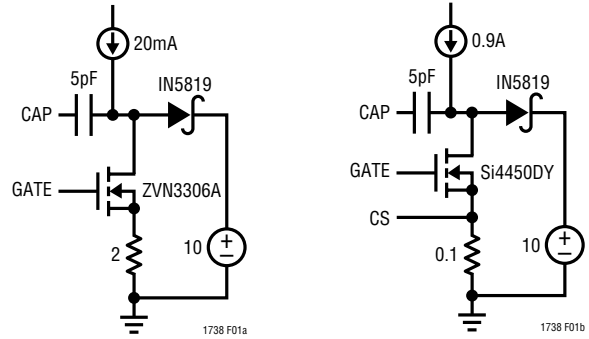
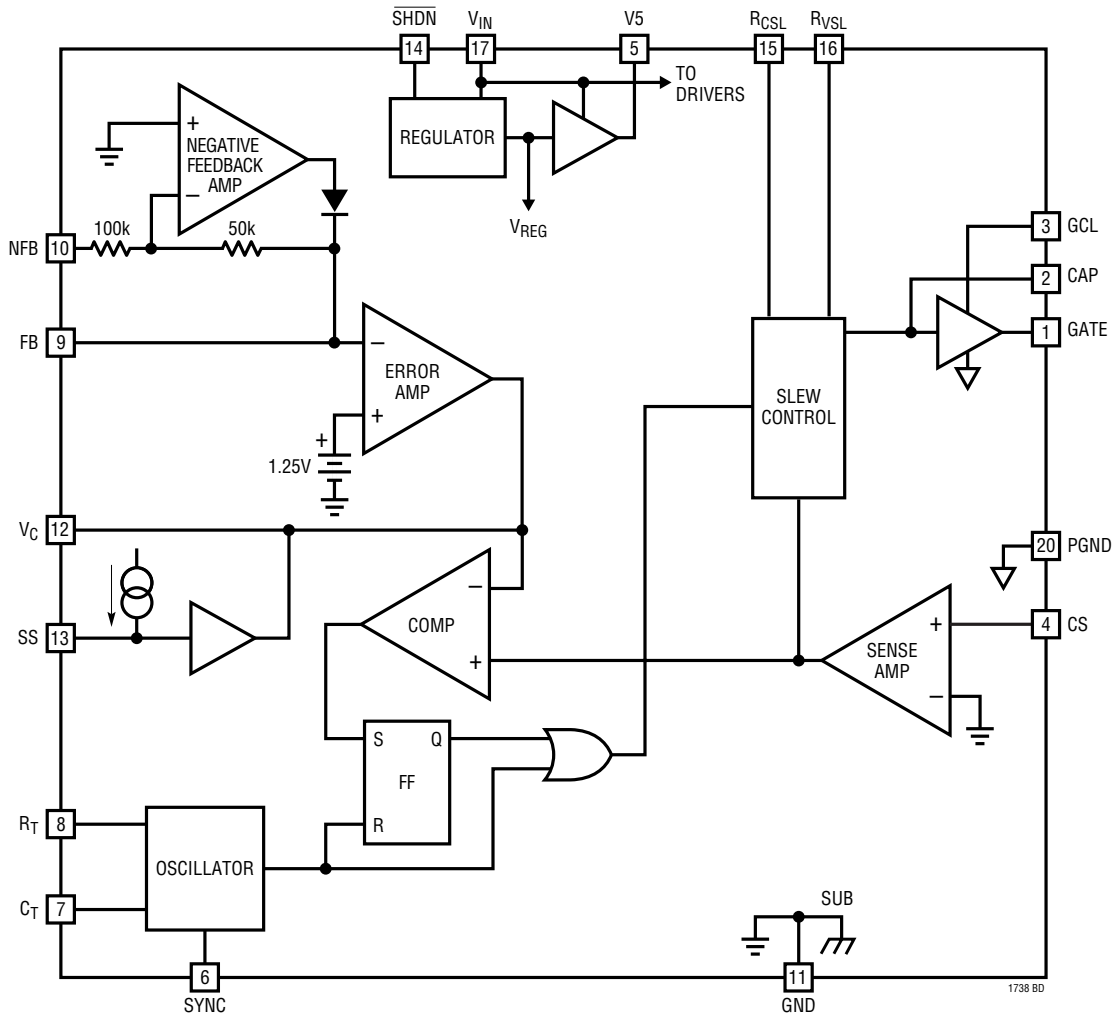

Figure 1a. Typical Test Circuitry Figure 1b. Test Circuit for Slew

BLOCK DIAGRAM



OPERATION

In noise sensitive applications switching regulators tend to be ruled out as a power supply option due to their propensity for generating unwanted noise. When switching supplies are required due to efficiency or input/output constraints, great pains must be taken to work around the noise generated by a typical supply. These steps may include pre and post regulator filtering, precise synchronization of the power supply oscillator to an external clock, synchronizing the rest of the circuit to the power supply oscillator or halting power supply switching during noise sensitive operations. The LT1738 greatly simplifies the task of eliminating supply noise by enabling the design of an inherently low noise switching regulator power supply.

The LT1738 is a fixed frequency, current mode switching regulator with unique circuitry to control the voltage and current slew rates of the output switch. Current mode control provides excellent AC and DC line regulation and simplifies loop compensation.

Slew control capability provides much greater control over the power supply components that can create conducted and radiated electromagnetic interference. Compliance with EMI standards will be an easier task and will require fewer external filtering components.

The LT1738 uses an external N-channel MOSFET as the power switch. This allows the user to tailor the drive conditions to a wide range of voltages and currents.

CURRENT MODE CONTROL

Referring to the block diagram. A switching cycle begins with an oscillator discharge pulse, which resets the RS flip-flop, turning on the GATE driver and the external MOSFET. The switch current is sensed across the external sense resistor and the resulting voltage is amplified and compared to the output of the error amplifier (V_C pin). The driver is turned off once the output of the current sense amplifier exceeds the voltage on the V_C pin. In this way pulse by pulse current limit is achieved.

Internal slope compensation is provided to ensure stability under high duty cycle conditions.

Output regulation is obtained using the error amp to set the switch current trip point. The error amp is a

transconductance amplifier that integrates the difference between the feedback output voltage and an internal 1.25V reference. The output of the error amp adjusts the switch current trip point to provide the required load current at the desired regulated output voltage. This method of controlling current rather than voltage provides faster input transient response, cycle-by-cycle current limiting for better output switch protection and greater ease in compensating the feedback loop. The V_C pin is used for loop compensation and current limit adjustment. During normal operation the V_C voltage will be between 0.25V and 1.27V. An external clamp on V_C or SS may be used for lowering the current limit.

The negative voltage feedback amplifier allows for direct regulation of negative output voltages. The voltage on the NFB pin gets amplified by a gain of -0.5 and driven on to the FB input, i.e., the NFB pin regulates to $-2.5V$ while the amplifier output internally drives the FB pin to 1.25V as in normal operation. The negative feedback amplifier input impedance is 100k (typ) referred to ground.

Soft-Start

Control of the switch current during start up can be obtained by using the SS pin. An external capacitor from SS to ground is charged by an internal 9 μ A current source. The voltage on V_C cannot exceed the voltage on SS. Thus as the SS pin ramps up the V_C voltage will be allowed to ramp up. This will then provide for a smooth increase in switch maximum current. SS will be discharged as a result of the CS voltage exceeding the short circuit threshold of approximately 0.22V.

Slew Control

Control of output voltage and current slew rates is achieved via two feedback loops. One loop controls the MOSFET drain dV/dt and the other loop controls the MOSFET dI/dt .

The voltage slew rate uses an external capacitor between CAP and the MOSFET drain. This integrating cap closes the voltage feedback loop. The external resistor R_{VSL} sets the current for the integrator. The voltage slew rate is thus inversely proportional to both the value of capacitor and R_{VSL} .

OPERATION

The current slew feedback loop consists of the voltage across the external sense resistor, which is internally amplified and differentiated. The derivative is limited to a value set by R_{CSL} . The current slew rate is thus inversely proportional to both the value of sense resistor and R_{CSL} .

The two control loops are combined internally so that a smooth transition from current slew control to voltage slew control is obtained. When turning on, the driver current will slew before voltage. When turning off, voltage will slew before current. In general it is desirable to have R_{VSL} and R_{CSL} of similar value.

Internal Regulator

Most of the control circuitry operates from an internal 2.4V low dropout regulator that is powered from V_{IN} . The internal low dropout design allows V_{IN} to vary from 2.7V to 20V with stable operation of the controller. When $\overline{SHDN} < 1.3V$ the internal regulator is completely disabled.

5V Regulator

A 5V regulator is provided for powering external circuitry. This regulator draws current from V_{IN} and requires V_{IN} to be greater than 6.5V to be in regulation. It can sink or source 10mA. The output is current limited to prevent against destruction from accidental short circuits.

Safety and Protection Features

There are several safety and protection features on the chip. The first is overcurrent limit. Normally the gate driver will go low when the output of the internal sense amplifier exceeds the voltage on the V_C pin. The V_C pin is clamped such that maximum output current is attained when the CS pin voltage is 0.1V. At that level the outputs will be immediately turned off (no slew). The effect of this control is that the output voltage will foldback with overcurrent.

In addition, if the CS voltage exceeds 0.22V, the V_C and SS pins will be discharged to ground, resetting the soft-start function. Thus if a short is present this will allow for faster MOSFET turnoff and less MOSFET stress.

If the voltage on the FB pin exceeds regulation by approximately 0.22V, the outputs will immediately go low. The implication is that there is an overvoltage fault.

The voltage on GCL determines two features. The first is the maximum gate drive voltage. This will protect the MOSFET gate from overvoltage.

With GCL tied to a zener or an external voltage source then the maximum gate driver voltage is approximately $V_{GCL} - 0.2V$. If GCL is tied to V_{IN} , then the maximum gate voltage is determined by V_{IN} and is approximately $V_{IN} - 1.6V$. There is an internal 19V zener on the GCL pin that prevents the gate driver pin from exceeding approximately 19V.

In addition, the GCL voltage determines undervoltage lockout of the gate drive. This feature disables the gate driver if V_{IN} is too low to provide adequate voltage to turn on the MOSFET. This is helpful during start up to insure the MOSFET has sufficient gate drive to saturate.

If GCL is tied to a voltage source or zener less than 6.8V, the gate driver will not turn on until V_{IN} exceeds GCL voltage by 0.8V. For V_{GCL} above 6.5V, the gate drive is insured to be off for $V_{IN} < 7.3V$ and it will be turned on by $V_{GCL} + 0.8V$.

If GCL is tied to V_{IN} , the gate driver is always on (undervoltage lockout is disabled).

The gate drive has current limits for the drive currents. If the sink or source current is greater than 300mA then the current will be limited.

The 5V regulator also has internal current limiting that will only guarantee $\pm 10mA$ output current.

There is also an on chip thermal shutdown circuit that will turn off the output in the event the chip temperature rises to dangerous levels. Thermal shutdown has hysteresis that will cause a low frequency (<1kHz) oscillation to occur as the chip heats up and cools down.

The chip has an undervoltage lockout feature that will force the gate driver low in the event that V_{IN} drops below 2.5V. This insures predictable behavior during start up and shut down. \overline{SHDN} can be used in conjunction with an external resistor divider to completely disable the part if the input voltage is too low. This can be used to insure adequate voltage to reliably run the converter. See the section in Applications Information.

Table 1 summarizes these features.

OPERATION

Table 1. Safety and Protection Features

FEATURE	FUNCTION	EFFECT on GATE DRIVER	SLEW CONTROL	EFFECT on V _C , SS
Maximum Current Fault	Turn Off FET at Maximum Switch Current (V _{SENSE} = 0.1)	Immediately Goes Low	Overridden	None
Short-Circuit Fault	Turn Off FET and Reset V _C for Short-Circuit (V _{SENSE} = 0.22)	Immediately Goes Low	Overridden	Discharge V _C , SS to GND
Overvoltage Fault	Turn Off Driver If FB > V _{REG} + 0.22V (Output Overvoltage)	Immediately Goes Low	Overridden	None
GCL Clamp	Set Max Gate Voltage to Prevent FET Gate Breakdown	Limits Max Voltage	None	None
Gate Drive Undervoltage Lockout	Disable Gate Drive When V _{IN} Is Too Low. Set Via GCL Pin	Immediately Goes Low	Overridden	None
Thermal Shutdown	Turn Off Driver If Chip Temperature Is Too Hot	Immediately Goes Low	Overridden	None
V _{IN} Undervoltage Lockout	Disable Part When V _{IN} ≅ 2.55V	Immediately Goes Low	Overridden	None
Gate Drive Source and Sink Current Limit	Limit Gate Drive Current	Limit Drive Current	None	None
V5 Source/Sink Current Limit	Limit Current from V5	None	None	None
Shutdown	Disable Part When SHDN̄ < 1.3V			

APPLICATIONS INFORMATION

Reducing EMI from switching power supplies has traditionally invoked fear in designers. Many switchers are designed solely on efficiency and as such produce waveforms filled with high frequency harmonics that then propagate through the rest of the system.

The LT1738 provides control over two of the more important variables for controlling EMI with switching inductive loads: switch voltage slew rate and switch current slew rate. The use of this part will reduce noise and EMI over conventional switch mode controllers. Because these variables are under control, a supply built with this part will exhibit far less tendency to create EMI and less chance of encountering problems during production.

It is beyond the scope of this data sheet to get into EMI fundamentals. Application Note 70 contains much information concerning noise in switching regulators and should be consulted.

Oscillator Frequency

The oscillator determines the switching frequency and therefore the fundamental positioning of all harmonics. The use of good quality external components is important

to ensure oscillator frequency stability. The oscillator is of a sawtooth design. A current defined by external resistor R_T is used to charge and discharge the capacitor C_T. The discharge rate is approximately ten times the charge rate.

By allowing the user to have control over both components, trimming of oscillator frequency can be more easily achieved.

The external capacitance C_T is chosen by:

$$C_T (\text{nF}) = \frac{2180}{f(\text{kHz}) \cdot R_T (\text{k}\Omega)}$$

where f is the desired oscillator frequency in kHz. For R_T equal to 16.9k, this simplifies to:

$$C_T (\text{nF}) = \frac{129}{f(\text{kHz})}$$

e.g., C_T = 1.29nF for f = 100kHz

Nominally R_T should be 16.9k. Since it sets up current, its temperature coefficient should be selected to compliment the capacitor. Ideally, both should have low temperature coefficients.

APPLICATIONS INFORMATION

Oscillator frequency is important for noise reduction in two ways. First the lower the oscillator frequency the lower the waveform's harmonics, making it easier to filter them. Second the oscillator will control the placement of the output voltage harmonics which can aid in specific problems where you might be trying to avoid a certain frequency bandwidth.

Oscillator Sync

If a more precise frequency is desired (e.g., to accurately place harmonics) the oscillator can be synchronized to an external clock. Set the RC timing components for an oscillator frequency 10% lower than the desired sync frequency.

Drive the SYNC pin with a square wave (with greater than 2V amplitude). The rising edge of the sync square wave will initiate clock discharge. The sync pulse should have a minimum pulse width of 0.5 μ s.

Be careful in sync'ing to frequencies much different from the part since the internal oscillator charge slope determines slope compensation. It would be possible to get into subharmonic oscillation if the sync doesn't allow for the charge cycle of the capacitor to initiate slope compensation. In general, this will not be a problem until the sync frequency is greater than 1.5 times the oscillator free-run frequency.

Slew Rate Setting

The primary reason to use this part is to gain advantage of lower EMI and noise due to the slew control. The rolloff in higher frequency harmonics has its theoretical basis with two primary components. First, the clock frequency sets the fundamental positioning of harmonics and second, the associated normal frequency rolloff of harmonics.

This part creates a second higher frequency rolloff of harmonics that inversely depends on the slew time, the time that voltage or current spends between the off state and on state. This time is adjustable through the choice of the slew resistors, the external resistors to ground on the R_{VSL} and R_{CSL} pins and the external components used for the external voltage feedback capacitor C_V (from CAP to the MOSFET drain) and the sense resistor. Lower slew

rates (longer slew times, lower rolloff frequency for harmonics) are created with higher values of R_{VSL} , R_{CSL} , C_V and the current sense resistor.

Setting the voltage and current slew rates should be done empirically. The most practical way of determining these components is to set C_V and the sense resistor value. Then, start by making R_{VSL} , R_{CSL} each a 50k resistor pot in series with 3.3k. Starting from the lowest resistor setting (fast slew) adjust the pots until the noise level meets your guidelines. Note that slower slewing waveforms will dissipate more power so that efficiency will drop. You can monitor this as you make your slew adjustment by measuring input and output voltage and their respective currents. Monitor the MOSFET temperature as slew rates are slowed. The MOSFET will heat up as efficiency decreases.

Measuring noise should be done carefully. It is easy to introduce noise by poor measurement techniques. Consult AN70 for recommended measurement techniques. Keeping probe ground leads very short is essential.

Usually it will be desirable to keep the voltage and current slew resistors approximately the same. There are circumstances where a better optimization can be found by adjusting each separately, but as these values are separated further, a loss of independence of control may occur.

It is possible to use a single slew setting resistor. In this case the R_{VSL} and R_{CSL} pins are tied together. A resistor with a value of 1.8k to 34k (one half the individual resistors) can then be tied from these pins to ground.

In general only the R_{CSL} value will be available for adjustment of current slew. The current slew time also depends on the current sense resistor but this resistor is normally set with consideration of the maximum current in the MOSFET.

Setting the voltage slew also involves selection of the capacitor C_V . The voltage slew time is proportional to the output voltage swing (basically input voltage), the external voltage feedback capacitor and the R_{VSL} value. Thus at higher input voltages smaller capacitors will be used with lower R_{VSL} values. For a starting point use Table 2.

APPLICATIONS INFORMATION

Table 2

INPUT VOLTAGE	CAPACITOR VALUE
< 25V	5pF
50V	2.5pF
100V	1pF

Smaller value capacitors can be made in two ways. The first is simply combining two capacitors in series. The equivalent capacitance is then $(C1 \cdot C2)/(C1 + C2)$.

The second method makes use of a capacitor divider. Care should be taken that the voltage rating of the capacitor satisfies the full voltage swing thus essentially the same rating as the MOSFET.

The equivalent slew capacitance for Figure 2 is $(C1 \cdot C2)/(C1 + C2 + C3)$.

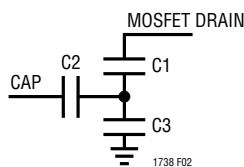

Figure 2

Positive Output Voltage Setting

Sensing of a positive output voltage is usually done using a resistor divider from the output to the FB pin. The positive input to the error amp is connected internally to a 1.25V bandgap reference. The FB pin will regulate to this voltage.

Referring to Figure 3, R1 is determined by:

$$R1 = R2 \left(\frac{V_{OUT}}{1.25} - 1 \right)$$

The FB bias current represents a small error and can usually be ignored for values of $R1 || R2$ up to 10k.

One word of caution, sometimes a feedback zero is added to the control loop by placing a capacitor across R1. If the feedback capacitively pulls the FB pin above the internal regulator voltage (2.4V), output regulation may be disrupted. A series resistance with the feedback pin can eliminate this potential problem. There is an internal clamp on FB that clamps at 0.7V above the regulation voltage that should also help prevent this problem.

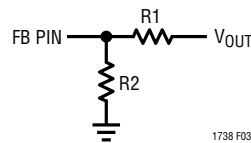

Figure 3

Negative Output Voltage Setting

Negative output voltage can be sensed using the NFB pin. In this case regulation will occur when the NFB pin is at -2.5V. The nominal input bias current for the NFB is $-25\mu A$ (I_{NFB}), which needs to be accounted for in setting up the divider.

Referring to Figure 4, R1 is chosen such that:

$$R1 = R2 \left(\frac{|V_{OUT}| - 2.5}{2.5 + R2 \cdot 25\mu A} \right)$$

A suggested value for R2 is 2.5k. The NFB pin is normally left open if the FB pin is being used.

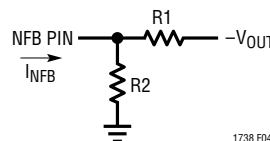

Figure 4

Dual Polarity Output Voltage Sensing

Certain applications may benefit from sensing both positive and negative output voltages. When doing this each output voltage resistor divider is individually set as previously described. When both FB and NFB pins are used, the LT1738 will act to prevent either output from going beyond its set output voltage. The highest output (lightest load) will dominate control of the regulator. This technique would prevent either output from going unregulated high at no load. However, this technique will also compromise output load regulation.

Shutdown

If \overline{SHDN} is pulled low, the regulator will turn off. As the \overline{SHDN} pin voltage is increased from ground the internal bandgap regulator will be powered on. This will set a 1.39V threshold for turn on of the internal regulator that runs

1738fa

APPLICATIONS INFORMATION

most of the control circuitry of the regulator. Note after the control circuitry powers on, gate driver activity will depend on the voltage of V_{IN} with respect to the voltage on GCL .

As the \overline{SHDN} pin enables the internal regulator a $24\mu A$ current will be sourced from the pin that can provide hysteresis for undervoltage lockout. This hysteresis can be used to prevent part shutdown due to input voltage sag from an initial high current draw.

In addition to the current hysteresis, there is also approximately 100mV of voltage hysteresis on the \overline{SHDN} pin.

When the \overline{SHDN} pin is greater than 2.2V, the hysteretic current from the part will be reduced to essentially zero.

If a resistor divider is used to set the turn on threshold then the resistors are determined by the following equations:

$$V_{ON} = \left(\frac{RA + RB}{RB} \right) \cdot V_{SHDN}$$

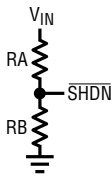
$$V_{HYST} = RA \cdot \left(\frac{\Delta V_{SHDN}}{RA \parallel RB} + I_{SHDN} \right)$$

Reworking these equations yields:

$$RA = \frac{(V_{HYST} \cdot V_{SHDN} - V_{ON} \cdot \Delta V_{SHDN})}{(I_{SHDN} \cdot V_{SHDN})}$$

$$RB = \frac{(V_{HYST} \cdot V_{SHDN} - V_{ON} \cdot \Delta V_{SHDN})}{[I_{SHDN} \cdot (V_{ON} - V_{SHDN})]}$$

So if we wanted to turn on at 20V with 2V of hysteresis:

$$RA = \frac{2V \cdot 1.39V - 20V \cdot 0.1V}{24\mu A \cdot 1.39V} = 23.4k$$

$$RB = \frac{2V \cdot 1.39V - 20V \cdot 0.1V}{24\mu A \cdot (20V - 1.39V)} = 1.75k$$

Resistor values could be altered further by adding zeners in the divider string. A resistor in series with \overline{SHDN} pin could further change hysteresis without changing turn on voltage.

Frequency Compensation

Loop frequency compensation is accomplished by way of a series RC network on the output of the error amplifier (V_C pin).

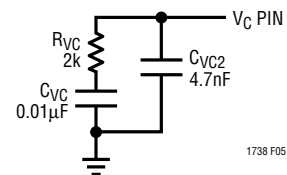

Figure 5

Referring to Figure 5, the main pole is formed by capacitor C_{VC} and the output impedance of the error amplifier (approximately 400kΩ). The series resistor R_{VC} creates a “zero” which improves loop stability and transient response. A second capacitor C_{VC2} , typically one-tenth the size of the main compensation capacitor, is sometimes used to reduce the switching frequency ripple on the V_C pin. V_C pin ripple is caused by output voltage ripple attenuated by the output divider and multiplied by the error amplifier. Without the second capacitor, V_C pin ripple is:

$$V_{CPINRIPPLE} = \frac{1.25 \cdot V_{RIPPLE} \cdot gm \cdot R_{VC}}{V_{OUT}}$$

where V_{RIPPLE} = Output ripple (V_{P-P})

gm = Error amplifier transconductance

R_{VC} = Series resistor on V_C pin

V_{OUT} = DC output voltage

To prevent irregular switching, V_C pin ripple should be kept below 50mV_{P-P}. Worst-case V_C pin ripple occurs at maximum output load current and will also be increased if poor quality (high ESR) output capacitors are used. The addition of a 0.0047μF capacitor for C_{VC2} pin reduces switching frequency ripple to only a few millivolts. A low value for R_{VC} will also reduce V_C pin ripple, but loop phase margin may be inadequate.

APPLICATIONS INFORMATION

Setting Current Limit

The sense resistor sets the value for maximum operating current. When the CS pin voltage is 0.1V the gate driver will immediately go low (no slew control). Therefore the sense resistor value should be set to $R_S = 0.1V/I_{SW(PEAK)}$, where $I_{SW(PEAK)}$ is the peak current in the MOSFET. $I_{SW(PEAK)}$ will depend on the topology and component values and tolerances. Certainly it should be set below the saturation current value for the inductor.

If the CS pin voltage is 0.22V in addition to the driver going low, V_C and SS will be discharged to ground. This is to provide additional protection in the event of a short circuit. By discharging V_C and SS the MOSFET will not be stressed as hard on subsequent cycles since the current trip will be set lower.

Turn off of the MOSFET will normally be inhibited for about 100ns at the start of every turn on cycle. This is to prevent noise from interfering with normal operation of the controller. This current sense blanking does not prevent the outputs from being turned off in the event of a fault. Slewing of the gate voltage effectively provides additional blanking.

Traces to the SENSE resistor should be kept short and wide to minimize resistance and inductance. Large interwinding capacitance in the transformer or high capacitance on the drain of the MOSFET will produce a current pulse through the sense resistor during drain voltage slewing. The magnitude of the pulse is $C \cdot dV/dt$ where C is the capacitance and dV/dt is the voltage slew rate which is controlled by the part. This pulse will increase the sensed current on switch turn on and if large enough can cause premature MOSFET turn off. If this occurs, the inductor transformer may need a different winding technique (see AN39) or alternatively, a blanking circuit can be used. Please contact the LTC applications group for support if required.

Soft-Start

The soft-start pin is used to provide control of switching current during startup. The maximum voltage on the V_C pin is approximately the voltage on the SS pin. A current source will linearly charge a capacitor on the SS pin. The V_C pin voltage will thus ramp up also. The approximate time for the voltage on these pins to ramp up is $(1.31V/9\mu A) \cdot C_{SS}$ or approximately 146ms per μF .

The soft-start current will be initiated as soon as the part turns on. Soft-start will be reinitiated after a short-circuit fault.

Thermal Considerations

Most of the IC power dissipation is derived from the V_{IN} pin. The V_{IN} current depends on a number of factors including: oscillator frequency; loads on V5; slew settings; gate charge current. Additional power is dissipated if V5 sinks current and during the MOSFET gate discharge.

The power dissipation in the IC will be the sum of:

- 1) The RMS V_{IN} current times V_{IN}
- 2) V5 RMS sink current times 5V
- 3) The gate drive's RMS discharge current times voltage.

Because of the strong V_{IN} component it is advantageous to operate the LT1738 at as low a V_{IN} as possible.

It is always recommended that package temperature be measured in each application. The part has an internal thermal shutdown to minimize the chance of IC destruction but this should not replace careful thermal design.

The thermal shutdown feature does not protect the external MOSFET. A separate analysis must be done for this device to insure that it is operating within safe limits.

Once IC power dissipation, P_{DIS} , is determined die junction temperature is then computed as:

$$T_J = T_{AMB} + P_{DIS} \cdot \theta_{JA}$$

where T_{AMB} is ambient temperature and θ_{JA} is the package thermal resistance. For the 20-pin SSOP, θ_{JA} is 100°C/W.

Choosing The Inductor

For a boost converter, inductor selection involves trade-offs of size, maximum output power, transient response and filtering characteristics. Higher inductor values provide more output power and lower input ripple. However, they are physically larger and can impede transient response. Low inductor values have high magnetizing current, which can reduce maximum power and increase input current ripple.

APPLICATIONS INFORMATION

The following procedure can be used to handle these trade-offs:

1. Assume that the average inductor current for a boost converter is equal to load current times V_{OUT}/V_{IN} and decide whether the inductor must withstand continuous overload conditions. If average inductor current at maximum load current is 0.5A, for instance, a 0.5A inductor may not survive a continuous 1.5A overload condition. Also be aware that boost converters are not short-circuit protected, and under output short conditions, only the available current of the input supply limits inductor current.
2. Calculate peak inductor current at full load current to ensure that the inductor will not saturate. Peak current can be significantly higher than output current, especially with smaller inductors and lighter loads, so don't omit this step. Powdered iron cores are forgiving because they saturate softly, whereas ferrite cores saturate abruptly. Other core materials fall in between. The following formula assumes continuous mode operation but it errs only slightly on the high side for discontinuous mode, so it can be used for all conditions.

$$I_{PEAK} = I_{OUT} \left(\frac{V_{OUT}}{V_{IN}} + \frac{V_{IN}(V_{OUT} - V_{IN})}{2 \cdot L \cdot f \cdot V_{OUT}} \right)$$

L = inductance value
 V_{IN} = supply voltage
 V_{OUT} = output voltage
 I = output current
 f = oscillator frequency

3. Choose a core geometry. For low EMI problems a closed structure should be used such as a pot core, ER core or toroid (see AN70 appendix I).
4. Select an inductor that can handle peak current, average current (heating effects) and fault current.
5. Finally, double check output voltage ripple.

The experts in the Linear Technology Applications department have experience with a wide range of inductor types and can assist you in making a good choice.

Capacitors

Correct choice of input and output capacitors can be very important to low noise switcher performance. Noise depends more on the ESR of the capacitors. In addition lower ESR can also improve efficiency.

Input capacitors must also withstand surges that occur during the switching of some types of loads. Some solid tantalum capacitors can fail under these surge conditions.

Design Note 95 offers more information but the following is a brief summary of capacitor types and attributes.

Aluminum Electrolytic: Low cost and higher voltage. They will typically only be used for higher voltage applications. Large values will be needed for low ESR.

Specialty Polymer Aluminum: Panasonic has come out with their series CD capacitors. While they are only available for voltages below 16V, they have very low ESR and good surge capability.

Solid Tantalum: Small size and low impedance. Typically the maximum voltage rating is 50V. With large surge currents the capacitor may need to be derated or you need a special type such as the AVX TPS line.

OS-CON: Lower impedance than aluminum but only available for 35V or less. Form factor may be a problem.

Ceramic: Generally used for high frequency and high voltage bypass. They may resonate with their ESL before ESR becomes dominant. Recent multilayer ceramic (MLC) capacitors provide larger capacitance with low ESR.

There are continuous improvements being made in capacitors so consult with manufacturers as to your specific needs.

Input Capacitors

The input capacitor should have low ESR at high frequencies since this will be an important factor concerning how much conducted noise is generated.

There are two separate requirements for input capacitors. The first is for the supply to the part's V_{IN} pin. The V_{IN} pin will provide current for the part itself and the gate charge current.

APPLICATIONS INFORMATION

The worst component from an AC point is the gate charge current. The actual peak current depends on gate capacitance and slew rate, being higher for larger values of each. The total current can be estimated by gate charge and frequency of operation. Because of the slewing with this part gate charge is spread out over a longer time period than with a normal FET driver. This reduces capacitance requirements.

Typically the current will have spikes of under 100mA located at the gate voltage transitions. This is charge/discharge to and from the threshold voltage. Most slewing occurs with the gate voltage near threshold.

Since the part's V_{IN} will typically be under 15V many options are available for choice of capacitor. Values of input capacitor for just the V_{IN} requirement will typically be in the 50 μ F range with an ESR of under 0.1 Ω .

In addition to the part's supply, decoupling of the supply to the inductor needs to be considered. If this is the same supply as the V_{IN} pin then that capacitor will need to be increased. However, often with this part the inductor supply will be a higher voltage and as such will use a separate capacitor.

The inductor's decoupling capacitor will see the switch current as ripple.

The above switch current computation can be used to estimate the capacity for these capacitors.

$$C_{IN} = \frac{1}{\frac{\Delta V_{CAP}}{\Delta I_{SW(MAX)}} - ESR} \cdot \frac{DC_{MIN}}{f}$$

where ΔV_{CAP} is the allowed sag on the input capacitor. ESR is the equivalent series resistance for the cap. In general allowed sag will be a few tenths of a volt.

Output Filter Capacitor

The output capacitor is chosen both for capacity and ESR. The capacity must supply the load current in the switch on state. While slew control reduces higher frequency components of the ripple current in the capacitor, the capacitor ESR and the magnitude of the output ripple current controls the fundamental component. ESR should also be

low to reduce capacitor dissipation. Typically ESR should be below 0.05 Ω .

The capacitance value can be computed by consideration of desired load ripple, duty cycle and ESR.

$$C_{OUT} = \frac{1}{\frac{\Delta V_{OUT}}{\Delta I_L(MAX)} - ESR} \cdot \frac{DC_{MIN}}{f}$$

MOSFET Selection

There is a wide variety of MOSFETs to choose from for this part. The part will work with either normal threshold (3V to 4V) or logic level threshold devices (1V to 2V).

Select a voltage rating to insure under worst-case conditions that the MOSFET will not break down. Next choose an R_{ON} sufficiently low to meet both the power dissipation capabilities of the MOSFET package as well as overall efficiency needs of the converter.

The LT1738 can handle a large range of gate charges. However at very large charge stability may be affected.

The power dissipation in the MOSFET depends on several factors. The primary element is I^2R heating when the device is on. In addition, power is dissipated when the device is slewing. An estimate for power dissipation is:

$$P = \left\{ V_{IN} \cdot \frac{I^2 + \frac{\Delta I^2}{4}}{I_{SR}} + \frac{\left[V_{IN}^2 - R_{ON}^2 \cdot \left(I^2 + \frac{3 \cdot \Delta I^2}{4} \right) \right]}{V_{SR}} \right\} \cdot I$$

$$\cdot f + I^2 \cdot R_{ON} \cdot DC$$

where I is the average current, ΔI is the ripple current in the switch, I_{SR} is the current slew rate, V_{SR} is the voltage slew rate, f is the oscillator frequency, DC is the duty cycle and R_{ON} is the MOSFET on-resistance.

Setting GCL Voltage

Setting the voltage on the GCL pin depends on what type of MOSFET is used and the desired gate drive undervoltage lockout voltage.

APPLICATIONS INFORMATION

First determine the maximum gate drive that you require. Typically you will want it to be at least 2V greater than the rated threshold. Higher voltages will lower the on resistance and increase efficiency. Be certain to check the maximum allowed gate voltage. Often this is 20V but for some logic threshold MOSFETs it is only 8V to 10V.

V_{GCL} needs to be set approximately 0.2V above the desired max gate threshold. In addition V_{IN} needs to be at least 1.6V above the gate voltage.

The GCL pin can be tied to V_{IN} which will result in a maximum gate voltage of $V_{IN} - 1.6V$.

This pin also controls undervoltage lockout of the gate drive. The undervoltage lockout will prevent the MOSFET from switching until there is sufficient drive present.

If GCL is tied to a voltage source or zener less than 6.8V, the gate drivers will not turn on until V_{IN} exceeds the GCL voltage by 0.8V. For V_{GCL} above 6.5V, the gate drive is insured to be off for $V_{IN} < 7.3V$ and they will be turned on by $V_{GCL} + 0.8V$.

If GCL is tied to V_{IN} , the gate driver is always on (undervoltage lockout is disabled).

Approximately 50 μ A of current can be sourced from this pin if $V_{IN} > V_{GCL} + 0.8V$. This could be used to bias a zener.

The GCL pin has an internal 19V zener to ground that will provide a failsafe for maximum gate voltage.

As an example say we are using a Siliconix Si4480DY which has $R_{DS(ON)}$ rated at 6V. To get 6V, V_{GCL} needs to be set to 6.2V and V_{IN} needs to be at least 7.6V.

Gate Driver Considerations

In general, the MOSFET should be positioned as close to the part as possible to minimize inductance.

When the part is active the gate drive will be pulled low to less than 0.2V. When the part is off, the gate drive contains a 40k resistor in series with a diode to ground that will offer passive holdoff protection. If you are using some logic level MOSFETs this might not be sufficient. A resistor may be placed from gate to ground, however the value should be reasonably high to minimize DC losses and possible AC issues.

The gate drive source current comes from V_{IN} . The sink current exits through PGND. In general the decoupling cap should be placed close to these two pins.

Switching Diodes

In general, switching diodes should be Schottky diodes. Size and breakdown voltage depend on the specific converter. A lower forward drop will improve converter efficiency. No other special requirements are needed.

PCB LAYOUT CONSIDERATIONS

As with any switcher, careful consideration should be given to PC board layout. Because this part reduces high frequency EMI, the board layout is less critical. However, high currents and voltages still produce the need for careful board layout to eliminate poor and erratic performance.

Basic Considerations

Keep the high current loops physically small in area. The main loops are shown in Figure 6: the power switch loops (A) and the rectifier loop (B). These loops can be kept small by physically keeping the components close to one another. In addition, connection traces should be kept wide to lower resistance and inductances. Components should be placed to minimize connecting paths. Careful attention to ground connections must also be maintained. Be careful that currents from different high current loops do not get coupled into the ground paths of other loops. Using singular points of connection for the grounds is the best way to do this. The two major points of connection are the bottom of the input decoupling capacitor and the bottom of the output decoupling capacitor. Typically, the sense resistor device PGND and device GND will tie to the bottom of the input capacitor.

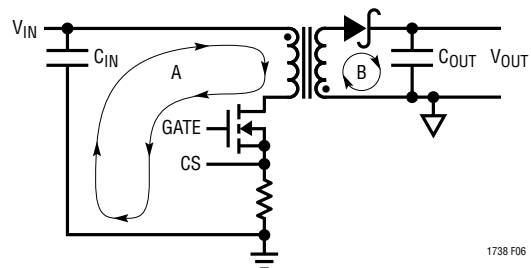

Figure 6

1738 F06

APPLICATIONS INFORMATION

There are two other loops to pay attention to. The current slew involves a high bandwidth control that goes through the MOSFET switch, the sense resistor and into the CS pin of the part and out the GATE pin to the MOSFET. Trace inductance and resistance should be kept low on the GATE drive trace. The CS trace should have low inductance.

Finally, care should be taken with the CAP pin. The part will tolerate stray capacitance to ground on this pin (<5pFs). However, stray capacitance to the MOSFET drain should be minimized. This path would provide an alternate capacitive path for the voltage slew.

MORE HELP

AN70 contains information about low noise switchers and measurement of noise and should be consulted. AN19 and AN29 also have general knowledge concerning switching regulators. Also, our Application Department is always ready to lend a helping hand.

PACKAGE DESCRIPTION

G Package
20-Lead Plastic SSOP (5.3mm)
 (Reference LTC DWG # 05-08-1640)

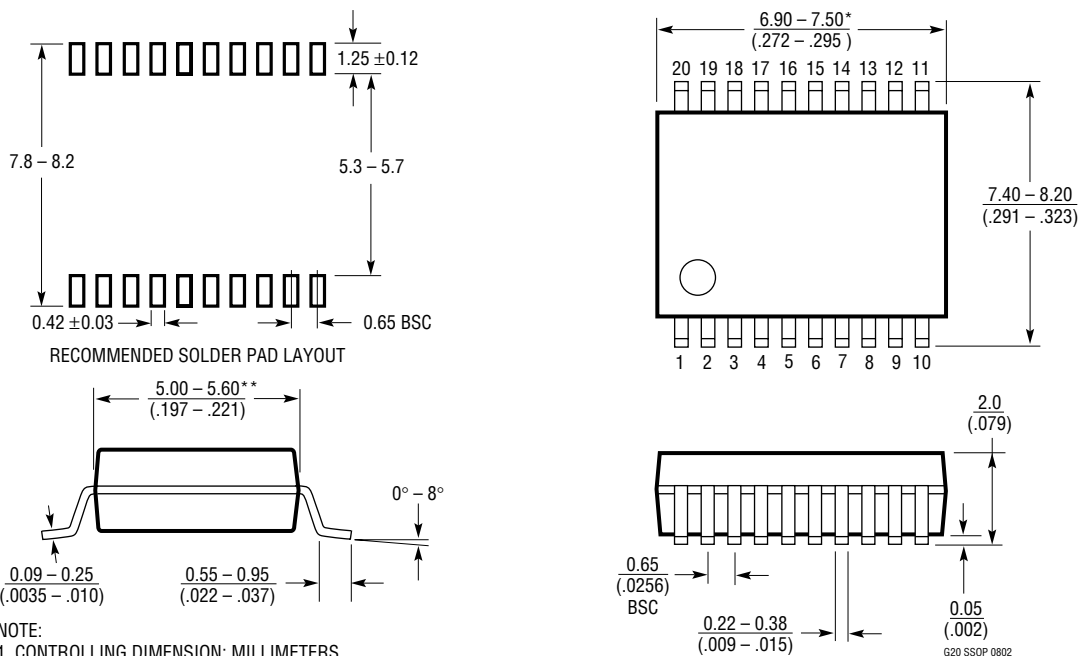

TYPICAL APPLICATION

Ultralow Noise 30W Offline Power Supply

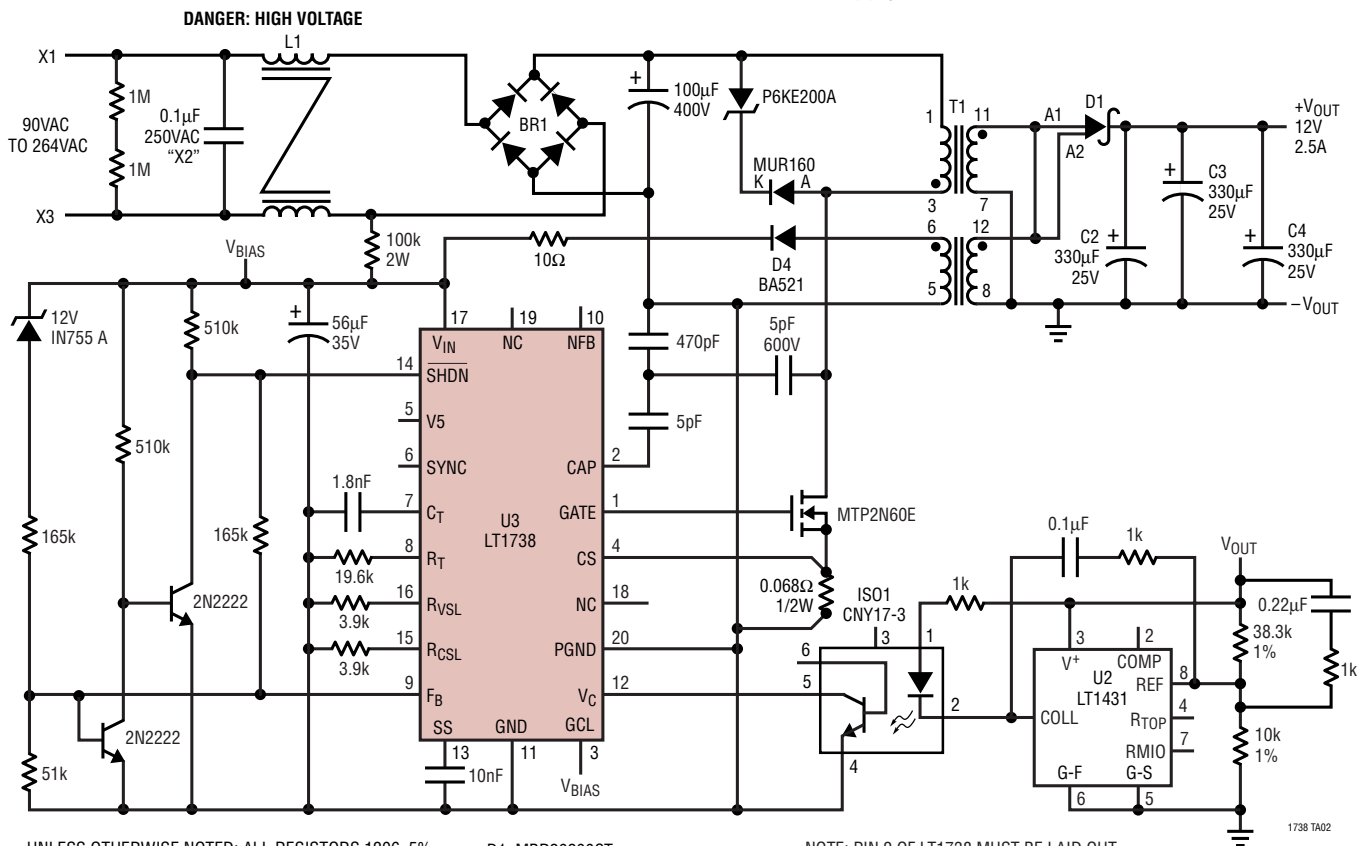

UNLESS OTHERWISE NOTED: ALL RESISTORS 1206, 5%
BR1: GENERAL INSTRUMENTS W06G
C2, C3, C4: SANYO MV-GX

D1: MBR20200CT
L1: HM18-10001
T1: PREMIER MAGNETICS POL-15033

NOTE: PIN 2 OF LT1738 MUST BE LAID OUT AWAY FROM FAST SLEWING NODES

INPUT FILTER IS REQUIRED TO ATTENUATE SWITCHING FREQUENCY HARMONICS AND PASS FCC CLASS B (LT1738 DOES NOT ATTENUATE THESE LOW FREQUENCY HARMONICS) MAIN ADVANTAGE WITH LT1738 IS IT MAKES SUPPRESSING THE HIGH FREQUENCY NOISE AND EMI EASY. THIS IS PARTICULARLY USEFUL FOR MEDICAL DEVICES BECAUSE THE AC LINE TO EARTH GND CAPS ON THE INPUT FILTER CAN BE ELIMINATED; ALLOWING THE DEVICE TO PASS THE EARTH GND LEAKAGE CURRENT MEDICAL SPECIFICATIONS.

RELATED PARTS

PART NUMBER	DESCRIPTION	COMMENTS
LT1683	Ultralow Noise Push-Pull DC/DC Controller	Dual Output (Push-Pull) Current Mode Architecture.
LT1425	Isolated Flyback Switching Regulator	Excellent Regulation without Transformer "Third Winding"
LT1533	Ultralow Noise 1A Switching Regulator	Push-Pull Design for Low Noise Isolated Supplies
LT1534	Ultralow Noise 2A Switching Regulator	Ultralow Noise Regulator for Boost Topologies
LT1576	1.5A, 200kHz Step-Down Switching Regulator	Constant Frequency, 1.21V Reference Voltage
LT176X Family	Low Dropout, Low Noise Linear Regulator	150mA to 3A, SOT-23 to TO-220
LT1777	Low Noise Step-Down Switching Regulator	Programmable di/dt; Internally Limited dV/dt
LTC1922-1	Synchronous Phase Modulated Full-Bridge Controller	Adaptive DirectSense™ Zero Voltage Switching, 50W to Kilowatts, Synchronous Rectification
LT3439	Ultralow Noise Transformer Driver	1A Push-Pull DC/DC Transformer Driver

DirectSense is a trademark of Linear Technology Corporation.