

## 2.5MHz, Over-The-Top Low Power, Rail-to-Rail Input and Output Op Amp in SOT-23

### FEATURES

- Operates with Inputs Above  $V^+$
- Rail-to-Rail Input and Output
- Low Profile (1mm) ThinSOT™ Package
- Gain Bandwidth Product: 2.5MHz
- Slew Rate: 2.1V/μs
- Low Input Offset Voltage: 3.5mV Max
- High Voltage Gain: 1000V/mV
- Single Supply Input Range: 0V to 18V
- Specified on 3V, 5V and ±5V Supplies
- Reverse Battery Protection to 18V
- Low Power: 750μA Supply Current Max
- Output Shutdown on 6-Lead Version
- High Output Current: 15mA Min
- Operating Temperature Range: -40°C to 85°C

### APPLICATIONS

- Portable Instrumentation
- Battery-Powered Systems
- Sensor Conditioning
- Supply Current Sensing
- MUX Amplifiers
- 4mA to 20mA Transmitters

### DESCRIPTION

The LT®1784 is a 2.5MHz op amp available in the small SOT-23 package that operates on all single and split supplies with a total voltage of 2.5V to 18V. The amplifier draws less than 750μA of quiescent current and has reverse battery protection, drawing negligible current for reverse supply voltages up to 18V.

The input range of the LT1784 includes ground, and a unique feature of this device is its Over-The-Top™ operation capability with either or both of its inputs above the positive rail. The inputs handle 18V both differential and common mode, independent of supply voltage. The input stage incorporates phase reversal protection to prevent false outputs from occurring even when the inputs are 9V below the negative supply.

The LT1784 can drive loads up to 15mA and still maintain rail-to-rail capability. A shutdown feature on the 6-lead version can disable the part, making the output high impedance and reducing quiescent current to 5μA. The LT1784 op amp is available in the 5- and 6-lead SOT-23 packages. For applications requiring lower power, refer to the LT1782 and LT1783 data sheets.

LT, LTC and LT are registered trademarks of Linear Technology Corporation. Over-The-Top and ThinSOT are trademarks of Linear Technology Corporation.

### TYPICAL APPLICATION

Programmable Gain,  $A_V = 2$ ,  $A_V = 20$ , 100kHz Amplifier

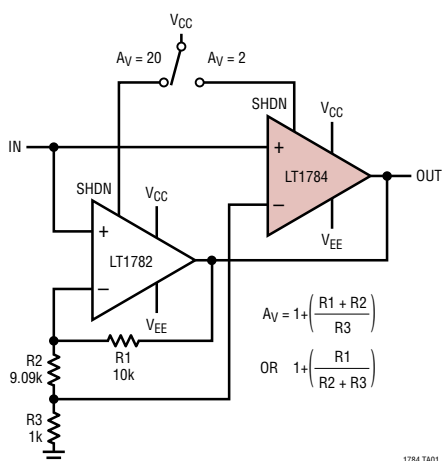

Programmable Gain Amplifier  
Frequency Response

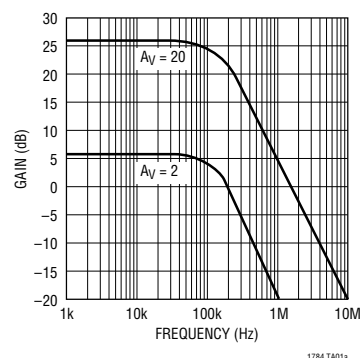

# LT1784

## ABSOLUTE MAXIMUM RATINGS (Note 1)

Total Supply Voltage ( $V^+$ to $V^-$ ) .....	18V	Operating Temperature Range (Note 10) .....	$-40^{\circ}\text{C}$ to $85^{\circ}\text{C}$
Input Differential Voltage .....	18V	Specified Temperature Range (Note 11) .....	$-40^{\circ}\text{C}$ to $85^{\circ}\text{C}$
Input Pin Voltage to $V^-$ .....	+24V/–10V	Junction Temperature .....	$150^{\circ}\text{C}$
Shutdown Pin Voltage Above $V^-$ .....	18V	Storage Temperature Range .....	$-65^{\circ}\text{C}$ to $150^{\circ}\text{C}$
Shutdown Pin Current .....	$\pm 10\text{mA}$	Lead Temperature (Soldering, 10 sec) .....	$300^{\circ}\text{C}$
Output Short-Circuit Duration (Note 2) .....	Indefinite		

## PACKAGE/ORDER INFORMATION

<p>TOP VIEW</p> <p>S5 PACKAGE 5-LEAD PLASTIC SOT-23</p> <p><math>T_{JMAX} = 150^{\circ}\text{C}</math>, <math>\theta_{JA} = 250^{\circ}\text{C}/\text{W}</math></p>	ORDER PART NUMBER	<p>TOP VIEW</p> <p>S6 PACKAGE 6-LEAD PLASTIC SOT-23</p> <p><math>T_{JMAX} = 150^{\circ}\text{C}</math>, <math>\theta_{JA} = 230^{\circ}\text{C}/\text{W}</math></p>	ORDER PART NUMBER
	LT1784CS5 LT1784IS5		LT1784CS6 LT1784IS6
	S5 PART MARKING		S6 PART MARKING
	LTJD LTSN		LTIW LTIIX

Consult LTC marketing for parts specified with wider operating temperature ranges.

## ELECTRICAL CHARACTERISTICS

The ● denotes specifications which apply over the specified temperature range, otherwise specifications are  $T_A = 25^{\circ}\text{C}$ .

$V_S = 3\text{V}$ ,  $0\text{V}$ ;  $V_S = 5\text{V}$ ,  $0\text{V}$ ,  $V_{CM} = V_{OUT} = \text{half supply}$ , for the 6-lead part  $V_{PIN5} = 0\text{V}$ , pulse power tested unless otherwise specified.

SYMBOL	PARAMETER	CONDITIONS	MIN	TYP	MAX	UNITS
$V_{OS}$	Input Offset Voltage	$T_A = 25^{\circ}\text{C}$		1.5	3.5	mV
		$0^{\circ}\text{C} \leq T_A \leq 70^{\circ}\text{C}$	●		4.2	mV
		$-40^{\circ}\text{C} \leq T_A \leq 85^{\circ}\text{C}$	●		4.5	mV
$\Delta V_{OS}/\Delta T$	Input Offset Voltage Drift (Note 7)	$-40^{\circ}\text{C} \leq T_A \leq 85^{\circ}\text{C}$	●	5	15	$\mu\text{V}/^{\circ}\text{C}$
$I_{OS}$	Input Offset Current	$V_{CM} = 18\text{V}$ (Note 3)	●	25	50	nA
			●		50	$\mu\text{A}$
$I_B$	Input Bias Current	$V_{CM} = 18\text{V}$ (Note 3)	●	250	500	nA
		SHDN or $V_S = 0\text{V}$ , $V_{CM} = 0\text{V}$ to $18\text{V}$	●	225	400	$\mu\text{A}$
			●	0.1		nA
$\Delta I_B/\Delta T$	Input Bias Current Drift	$-40^{\circ}\text{C} \leq T_A \leq 85^{\circ}\text{C}$	●	0.4		$\text{nA}/^{\circ}\text{C}$
	Input Noise Voltage	0.1Hz to 10Hz		1.5		$\mu\text{V}_{p-p}$
$e_n$	Input Noise Voltage Density	$f = 10\text{kHz}$		25		$\text{nV}/\sqrt{\text{Hz}}$
$i_n$	Input Noise Current Density	$f = 10\text{kHz}$		0.3		$\text{pA}/\sqrt{\text{Hz}}$
$R_{IN}$	Input Resistance	Differential	100	200		$\text{k}\Omega$
		Common Mode, $V_{CM} = 0\text{V}$ to $(V_{CC} - 1.2\text{V})$		150		$\text{M}\Omega$
		Common Mode, $V_{CM} = 0\text{V}$ to $18\text{V}$	45	80		$\text{k}\Omega$
$C_{IN}$	Input Capacitance			5		pF
$V_{CM}$	Input Voltage Range		●	0	18	V

## ELECTRICAL CHARACTERISTICS

The ● denotes specifications which apply over the specified temperature range, otherwise specifications are  $T_A = 25^\circ\text{C}$ .

$V_S = 3\text{V}, 0\text{V}$ ;  $V_S = 5\text{V}, 0\text{V}$ ,  $V_{\text{CM}} = V_{\text{OUT}} = \text{half supply}$ , for the 6-lead part  $V_{\text{PIN5}} = 0\text{V}$ , pulse power tested unless otherwise specified.

SYMBOL	PARAMETER	CONDITIONS	MIN	TYP	MAX	UNITS	
CMRR	Common Mode Rejection Ratio (Note 3)	$V_{\text{CM}} = 0\text{V}$ to $V_{\text{CC}} - 1.2\text{V}$	●	84	95	dB	
		$V_{\text{CM}} = 0\text{V}$ to $18\text{V}$ (Note 6)	●	60	70	dB	
PSRR	Power Supply Rejection Ratio	$V_S = 3\text{V}$ to $12.5\text{V}$ , $V_{\text{CM}} = V_O = 1\text{V}$	●	90	100	dB	
$A_{\text{VOL}}$	Large-Signal Voltage Gain	$V_S = 3\text{V}$ , $V_O = 500\text{mV}$ to $2.5\text{V}$ , $R_L = 10\text{k}$	●	133	1000	V/mV	
		$V_S = 3\text{V}$ , $0^\circ\text{C} \leq T_A \leq 70^\circ\text{C}$	●	90		V/mV	
		$V_S = 3\text{V}$ , $-40^\circ\text{C} \leq T_A \leq 85^\circ\text{C}$	●	60		V/mV	
		$V_S = 5\text{V}$ , $V_O = 500\text{mV}$ to $4.5\text{V}$ , $R_L = 10\text{k}$	●	266	1000	V/mV	
		$V_S = 5\text{V}$ , $0^\circ\text{C} \leq T_A \leq 70^\circ\text{C}$	●	180		V/mV	
		$V_S = 5\text{V}$ , $-40^\circ\text{C} \leq T_A \leq 85^\circ\text{C}$	●	120		V/mV	
$V_{\text{OL}}$	Output Voltage Swing LOW	No Load	●		4	10	mV
		$I_{\text{SINK}} = 5\text{mA}$	●		200	400	mV
		$V_S = 5\text{V}$ , $I_{\text{SINK}} = 10\text{mA}$	●		350	600	mV
$V_{\text{OH}}$	Output Voltage Swing HIGH	$V_S = 3\text{V}$ , No Load	●	2.885	2.93	V	
		$V_S = 3\text{V}$ , $I_{\text{SOURCE}} = 3\text{mA}$	●	2.600	2.8	V	
		$V_S = 5\text{V}$ , No Load	●	4.885	4.93	V	
		$V_S = 5\text{V}$ , $I_{\text{SOURCE}} = 10\text{mA}$	●	4.400	4.7	V	
$I_{\text{SC}}$	Short-Circuit Current (Note 2)	$V_S = 3\text{V}$ , Short to GND		4	7.5	mA	
		$V_S = 3\text{V}$ , Short to $V_{\text{CC}}$		15	30	mA	
		$V_S = 5\text{V}$ , Short to GND		12.5	22	mA	
		$V_S = 5\text{V}$ , Short to $V_{\text{CC}}$		20.0	40	mA	
	Minimum Supply Voltage		●	2.5	2.7	V	
	Reverse Supply Voltage	$I_S = -100\mu\text{A}$	●	18		V	
$I_S$	Supply Current (Note 4)		●	500	750	$\mu\text{A}$	
					900	$\mu\text{A}$	
	Supply Current, Shutdown	$V_{\text{PIN5}} = 2\text{V}$ , No Load (Note 8)	●	7	18	$\mu\text{A}$	
$I_{\text{SHDN}}$	SHDN Pin Current	$V_{\text{PIN5}} = 0.3\text{V}$ (On), No load (Note 8)	●	0.5		nA	
		$V_{\text{PIN5}} = 2\text{V}$ (Shutdown), No Load (Note 8)	●	2.0	8	$\mu\text{A}$	
		$V_{\text{PIN5}} = 5\text{V}$ (Shutdown), No Load (Note 8)		5.0		$\mu\text{A}$	
	Output Leakage Current, Shutdown	$V_{\text{PIN5}} = 2\text{V}$ , No Load (Note 8)	●	0.05	1	$\mu\text{A}$	
	Maximum SHDN Pin Current	$V_{\text{PIN5}} = 18\text{V}$ , No Load (Note 8)	●	10	30	$\mu\text{A}$	
$V_{\text{IL}}$	SHDN Pin Input Low Voltage	(Note 8)	●		0.3	V	
$V_{\text{IH}}$	SHDN Pin Input High Voltage	(Note 8)	●	2		V	
$t_{\text{ON}}$	Turn-On Time	$V_{\text{PIN5}} = 5\text{V}$ to $0\text{V}$ , $R_L = 10\text{k}$ (Note 8)		18		$\mu\text{s}$	
$t_{\text{OFF}}$	Turn-Off Time	$V_{\text{PIN5}} = 0\text{V}$ to $5\text{V}$ , $R_L = 10\text{k}$ (Note 8)		2.2		$\mu\text{s}$	
GBW	Gain Bandwidth Product (Note 4)	$f = 5\text{kHz}$		1.5	2.5	MHz	
		$0^\circ\text{C} \leq T_A \leq 70^\circ\text{C}$	●	1.2		MHz	
		$-40^\circ\text{C} \leq T_A \leq 85^\circ\text{C}$	●	1.1		MHz	
SR	Slew Rate (Note 5)	$A_V = -1$ , $R_L = \infty$		1.2	2.1	V/ $\mu\text{s}$	
		$0^\circ\text{C} \leq T_A \leq 70^\circ\text{C}$	●	1.1		V/ $\mu\text{s}$	
		$-40^\circ\text{C} \leq T_A \leq 85^\circ\text{C}$	●	1.0		V/ $\mu\text{s}$	
FPBW	Full-Power Bandwidth (Note 9)	$V_{\text{OUT}} = 2V_{\text{P-P}}$		350		kHz	
$t_S$	Settling Time	$V_S = 5\text{V}$ , $\Delta V_{\text{OUT}} = 2\text{V}$ to $0.1\%$ , $A_V = -1$		3.7		$\mu\text{s}$	
THD	Distortion	$V_S = 3\text{V}$ , $V_O = 1.8V_{\text{P-P}}$ , $A_V = 1$ , $R_L = 10\text{k}$ , $f = 1\text{kHz}$		0.001		%	

## LT1784

**ELECTRICAL CHARACTERISTICS**

The ● denotes specifications which apply over the specified temperature range, otherwise specifications are  $T_A = 25^\circ\text{C}$ .  
 $V_S = \pm 5\text{V}$ ,  $V_{CM} = 0\text{V}$ ,  $V_{OUT} = 0\text{V}$ , for the 6-lead part  $V_{PIN5} = V^-$ , pulse power tested unless otherwise specified.

SYMBOL	PARAMETER	CONDITIONS	MIN	TYP	MAX	UNITS
$V_{OS}$	Input Offset Voltage	$T_A = 25^\circ\text{C}$		1.6	3.75	mV
		$0^\circ\text{C} \leq T_A \leq 70^\circ\text{C}$	●		4.50	mV
		$-40^\circ\text{C} \leq T_A \leq 85^\circ\text{C}$	●		4.80	mV
$\Delta V_{OS}/\Delta T$	Input Offset Voltage Drift (Note 7)	$-40^\circ\text{C} \leq T_A \leq 85^\circ\text{C}$	●	5	15	$\mu\text{V}/^\circ\text{C}$
$I_{OS}$	Input Offset Current		●	25	50	nA
$I_B$	Input Bias Current		●	250	500	nA
$\Delta I_B/\Delta T$	Input Bias Current Drift	$0^\circ\text{C} \leq T_A \leq 70^\circ\text{C}$	●	0.4		$\text{nA}/^\circ\text{C}$
	Input Noise Voltage	0.1Hz to 10Hz		1.5		$\mu\text{V}_{P-P}$
$e_n$	Input Noise Voltage Density	$f = 1\text{kHz}$		25		$\text{nV}/\sqrt{\text{Hz}}$
$i_n$	Input Noise Current Density	$f = 1\text{kHz}$		0.3		$\text{pA}/\sqrt{\text{Hz}}$
$R_{IN}$	Input Resistance	Differential	●	100	200	$\text{k}\Omega$
		Common Mode, $V_{CM} = -5\text{V}$ to $13\text{V}$	●	45	80	$\text{k}\Omega$
$C_{IN}$	Input Capacitance			5		pF
$V_{CM}$	Input Voltage Range		●	-5	13	V
CMRR	Common Mode Rejection Ratio	$V_{CM} = -5\text{V}$ to $13\text{V}$	●	60	70	dB
$A_{VOL}$	Large-Signal Voltage Gain	$V_O = \pm 4\text{V}$ , $R_L = 10\text{k}$		50	100	$\text{V}/\text{mV}$
		$0^\circ\text{C} \leq T_A \leq 70^\circ\text{C}$	●	35		$\text{V}/\text{mV}$
$V_{OL}$	Output Voltage Swing LOW	No Load	●	-4.996	-4.99	V
		$I_{SINK} = 5\text{mA}$	●	-4.800	-4.60	V
		$I_{SINK} = 10\text{mA}$	●	-4.650	-4.40	V
$V_{OH}$	Output Voltage Swing HIGH	No Load	●	4.885	4.92	V
		$I_{SOURCE} = 5\text{mA}$	●	4.550	4.75	V
		$I_{SOURCE} = 10\text{mA}$	●	4.400	4.65	V
$I_{SC}$	Short-Circuit Current (Note 2)	Short to GND		15	27	mA
		$0^\circ\text{C} \leq T_A \leq 70^\circ\text{C}$	●	10		mA
PSRR	Power Supply Rejection Ratio	$V_S = \pm 1.5\text{V}$ to $\pm 9\text{V}$	●	90	100	dB
$I_S$	Supply Current		●	540	800	$\mu\text{A}$
					975	$\mu\text{A}$
	Supply Current, Shutdown	$V_{PIN5} = -3\text{V}$ , $V_S = \pm 5\text{V}$ , No Load (Note 8)	●	8	20	$\mu\text{A}$
$I_{SHDN}$	SHDN Pin Current	$V_{PIN5} = -4.7\text{V}$ (On), $V_S = \pm 5\text{V}$ , No load (Note 8)	●	0.5		nA
		$V_{PIN5} = -3\text{V}$ (Shutdown), $V_S = \pm 5\text{V}$ , No Load (Note 8)	●	2.0	8	$\mu\text{A}$
	Maximum SHDN Pin Current	$V_{PIN5} = 9\text{V}$ , $V_S = \pm 9\text{V}$ (Note 8)	●	10	30	$\mu\text{A}$
	Output Leakage Current, Shutdown	$V_{PIN5} = -7\text{V}$ , $V_S = \pm 9\text{V}$ , No Load (Note 8)	●	0.05	1	$\mu\text{A}$
$V_{IL}$	SHDN Pin Input Low Voltage	$V_S = \pm 5\text{V}$ (Note 8)	●		-4.7	V
$V_{IH}$	SHDN Pin Input High Voltage	$V_S = \pm 5\text{V}$ (Note 8)	●	-3		V
$t_{ON}$	Turn-On Time	$V_{PIN5} = 0\text{V}$ to $-5\text{V}$ , $R_L = 10\text{k}$ (Note 8)	●	18		$\mu\text{s}$
$t_{OFF}$	Turn-Off Time	$V_{PIN5} = -5\text{V}$ to $0\text{V}$ , $R_L = 10\text{k}$ (Note 8)	●	2.2		$\mu\text{s}$
GBW	Gain Bandwidth Product	$f = 5\text{kHz}$		1.55	2.6	MHz
		$0^\circ\text{C} \leq T_A \leq 70^\circ\text{C}$	●	1.30		MHz
		$-40^\circ\text{C} \leq T_A \leq 85^\circ\text{C}$	●	1.20		MHz

## ELECTRICAL CHARACTERISTICS

The ● denotes specifications which apply over the specified temperature range, otherwise specifications are  $T_A = 25^\circ\text{C}$ .  $V_S = \pm 5\text{V}$ ,  $V_{CM} = 0\text{V}$ ,  $V_{OUT} = 0\text{V}$ , for the 6-lead part  $V_{PIN5} = V^-$ , pulse power tested unless otherwise specified.

SYMBOL	PARAMETER	CONDITIONS	MIN	TYP	MAX	UNITS
SR	Slew Rate	$A_V = -1$ , $R_L = \infty$ , $V_O = \pm 4\text{V}$ , Measured at $V_O = \pm 2\text{V}$ $0^\circ\text{C} \leq T_A \leq 70^\circ\text{C}$ $-40^\circ\text{C} \leq T_A \leq 85^\circ\text{C}$	●	1.3	2.2	$\text{V}/\mu\text{s}$
			●	1.2		$\text{V}/\mu\text{s}$
			●	1.1		$\text{V}/\mu\text{s}$
FPBW	Full-Power Bandwidth (Note 9)	$V_{OUT} = 8V_{P-P}$		94		kHz
$t_S$	Settling Time	$V_S = 5\text{V}$ , $\Delta V_{OUT} = 4\text{V}$ to 0.1%, $A_V = 1$		3.4		$\mu\text{s}$

**Note 1:** Absolute Maximum Ratings are those values beyond which the life of a device may be impaired.

**Note 2:** A heat sink may be required to keep the junction temperature below absolute maximum.

**Note 3:**  $V_S = 5\text{V}$  limits are guaranteed by correlation to  $V_S = 3\text{V}$  and  $V_S = \pm 5\text{V}$  or  $V_S = \pm 9\text{V}$  tests.

**Note 4:**  $V_S = 3\text{V}$  limits are guaranteed by correlation to  $V_S = 5\text{V}$  and  $V_S = \pm 5\text{V}$  or  $V_S = \pm 9\text{V}$  tests.

**Note 5:** Guaranteed by correlation to slew rate at  $V_S = \pm 5\text{V}$ , and GBW at  $V_S = 5\text{V}$  and  $V_S = \pm 5\text{V}$  tests.

**Note 6:** This specification implies a typical input offset voltage of 5.7mV at  $V_{CM} = 18\text{V}$  and a maximum input offset voltage of 18mV at  $V_{CM} = 18\text{V}$ .

**Note 7:** This parameter is not 100% tested.

**Note 8:** Specifications apply to 6-lead SOT-23 with shutdown.

**Note 9:** Full-power bandwidth is calculated from the slew rate.  $\text{FPBW} = \text{SR}/2\pi V_P$ .

**Note 10:** The LT1784C is guaranteed functional over the operating temperature range  $-40^\circ\text{C}$  to  $85^\circ\text{C}$ .

**Note 11:** The LT1784C is guaranteed to meet specified performance from  $0^\circ\text{C}$  to  $70^\circ\text{C}$ . The LT1784C is designed, characterized and expected to meet specified performance from  $-40^\circ\text{C}$  to  $85^\circ\text{C}$  but is not tested or QA sampled at these temperatures. LT1784I is guaranteed to meet specified performance from  $-40^\circ\text{C}$  to  $85^\circ\text{C}$ .

## TYPICAL PERFORMANCE CHARACTERISTICS

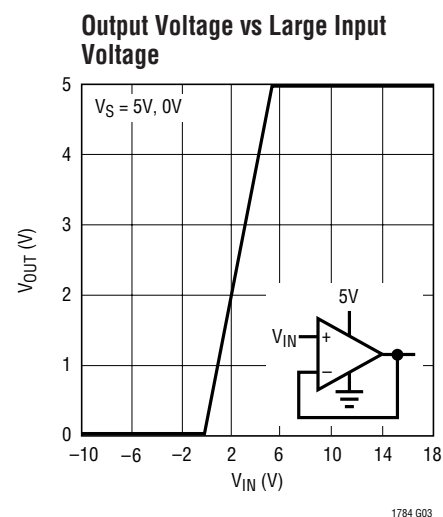
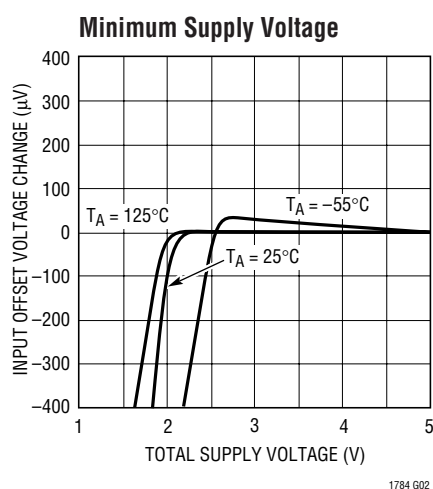
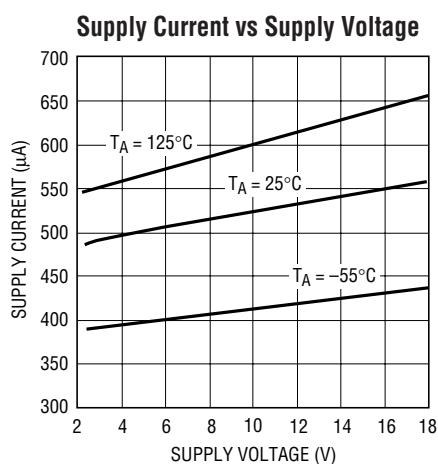

# LT1784

## TYPICAL PERFORMANCE CHARACTERISTICS

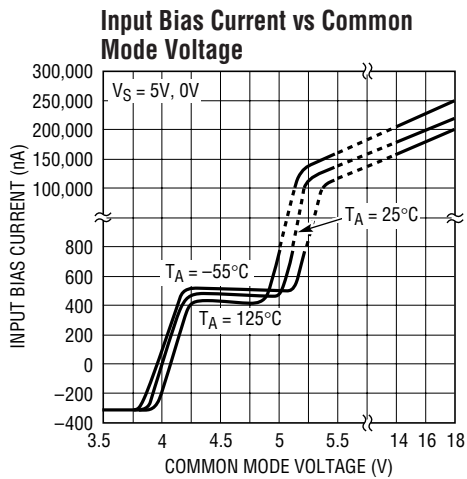

1784 G04

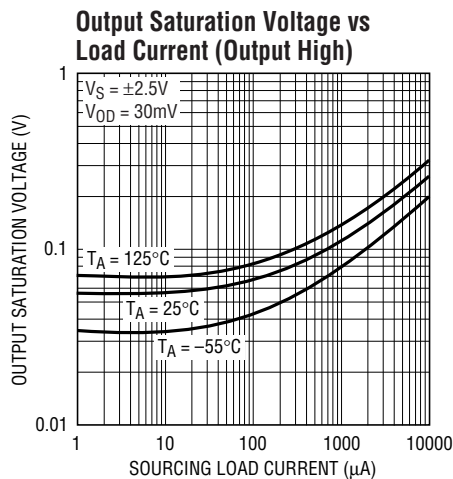

1784 G05

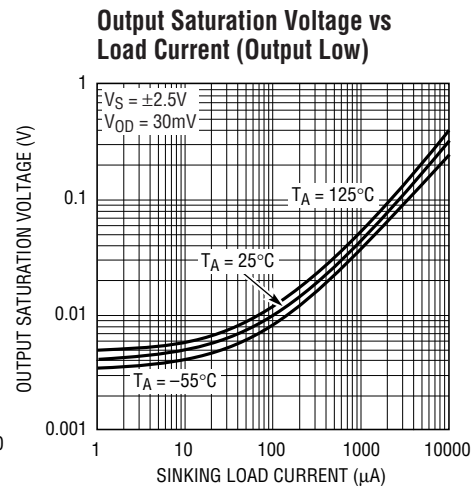

1784 G06

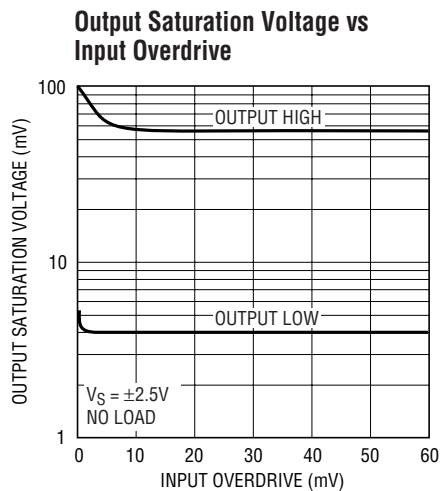

1784 G07

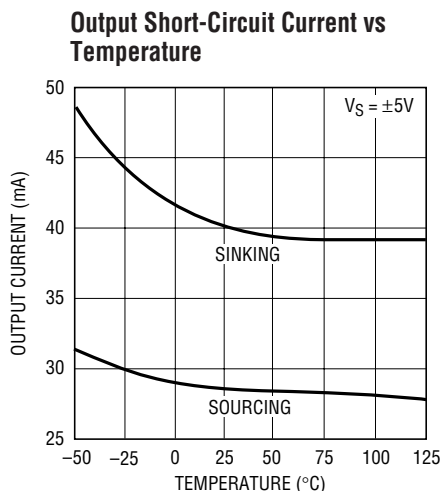

DC194 G02

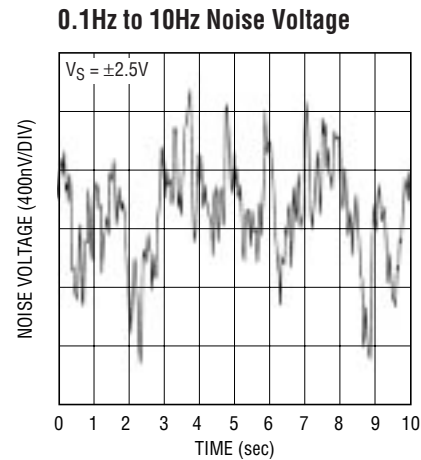

1784 G09

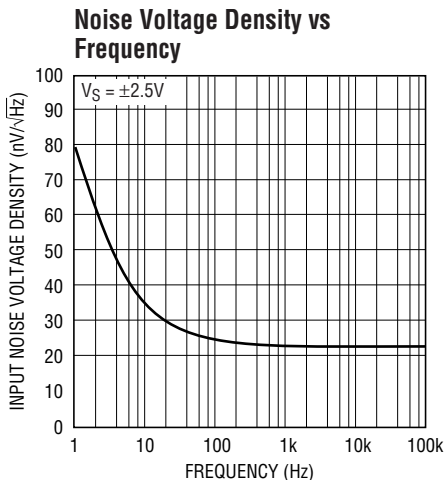

1784 G10

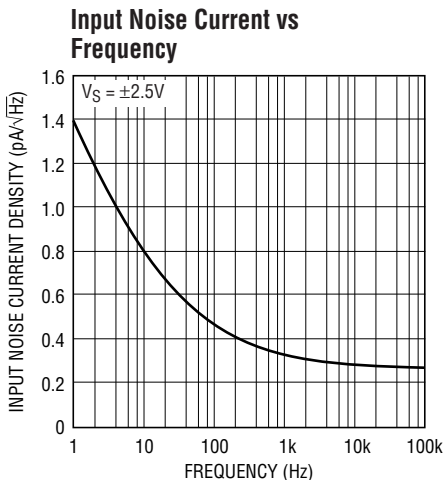

1784 G11

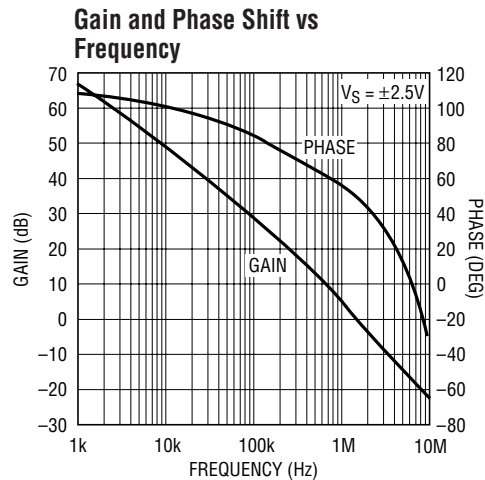

1784 G12

# TYPICAL PERFORMANCE CHARACTERISTICS

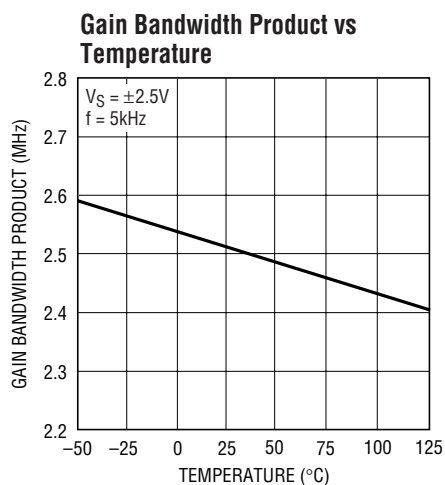

1784 G13

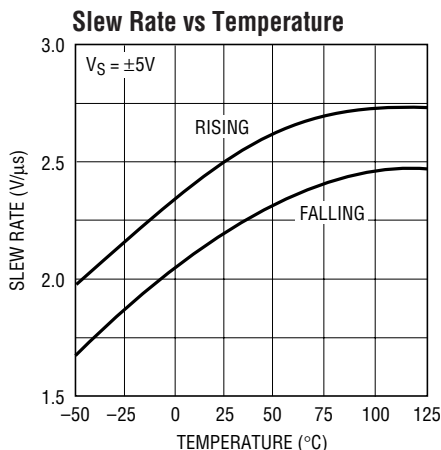

1784 G14

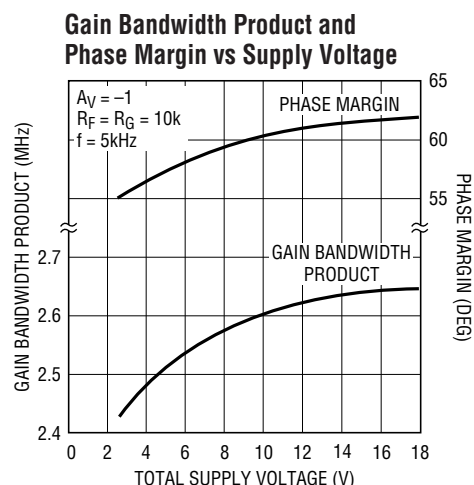

1784 G15

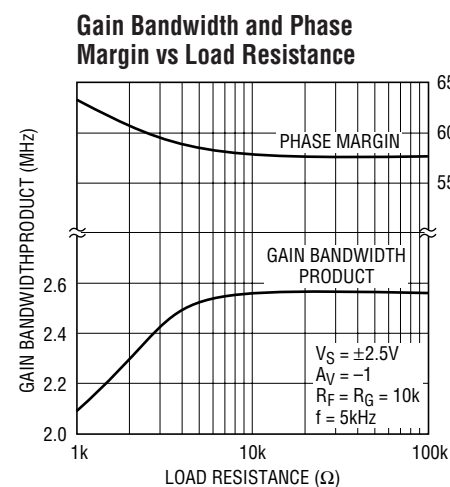

1784 G16

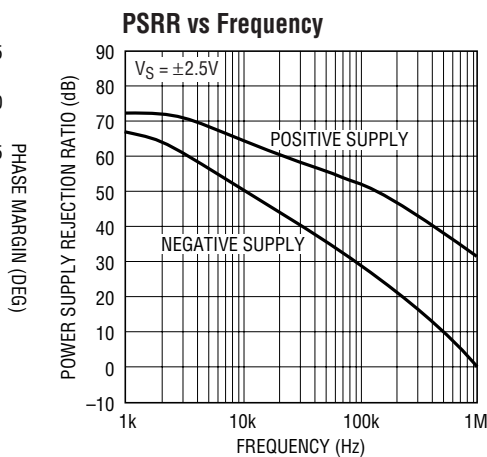

1784 G17

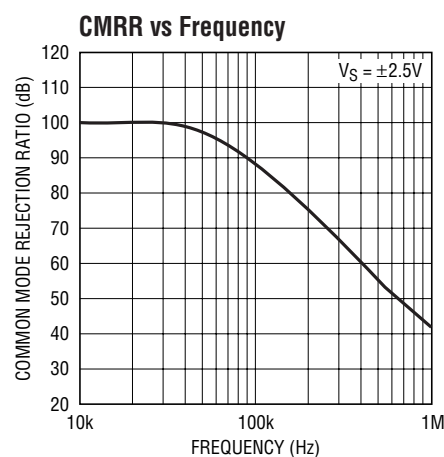

1784 G18

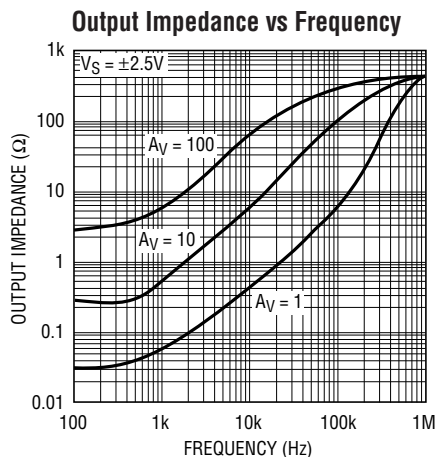

1784 G19

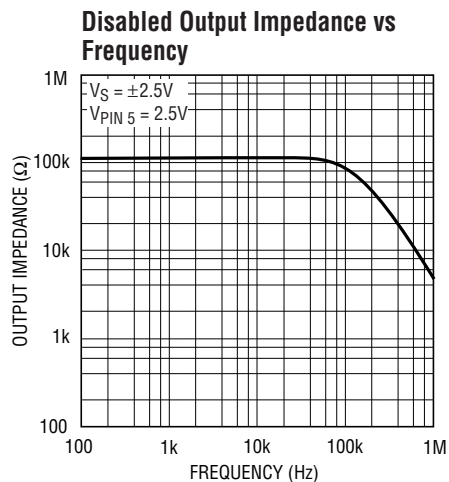

1784 G20

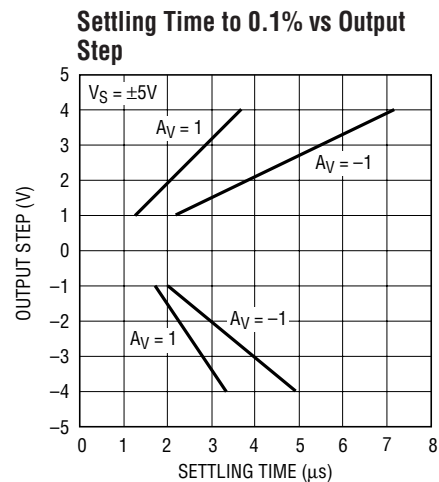

1784 G21

# LT1784

## TYPICAL PERFORMANCE CHARACTERISTICS

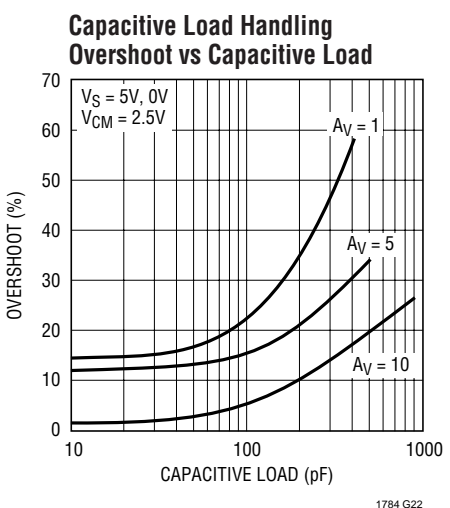

1784 G22

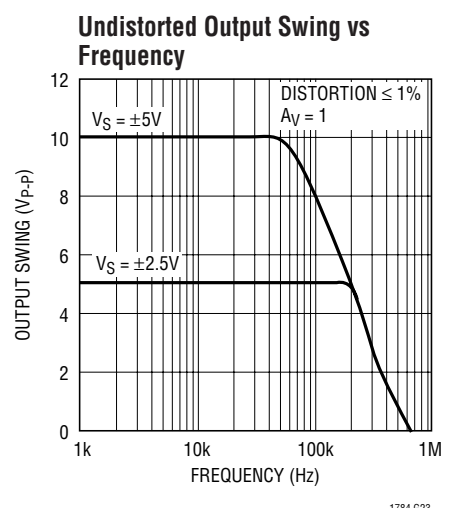

1784 G23

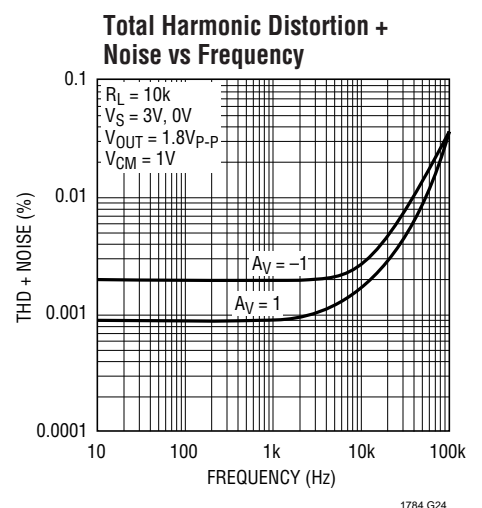

1784 G24

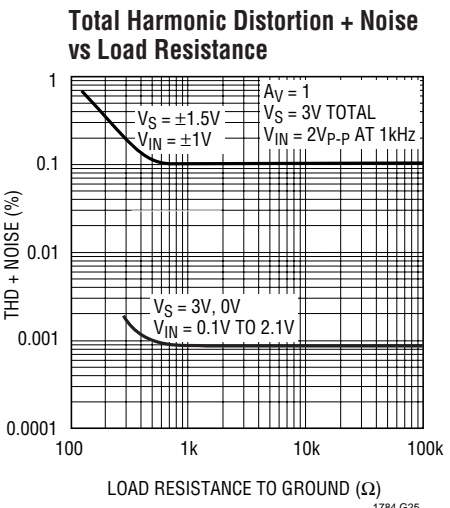

1784 G25

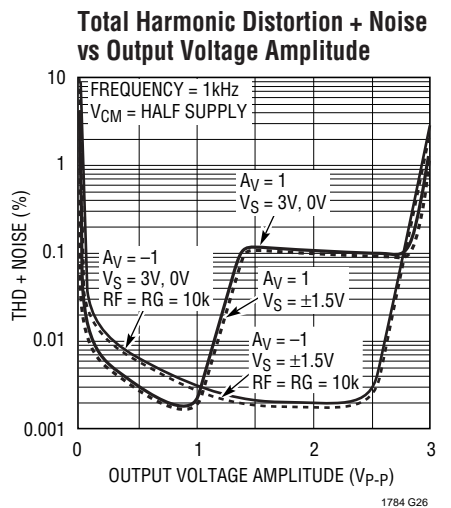

1784 G26

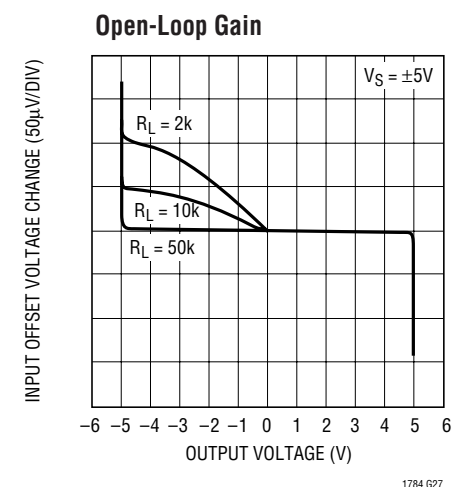

1784 G27

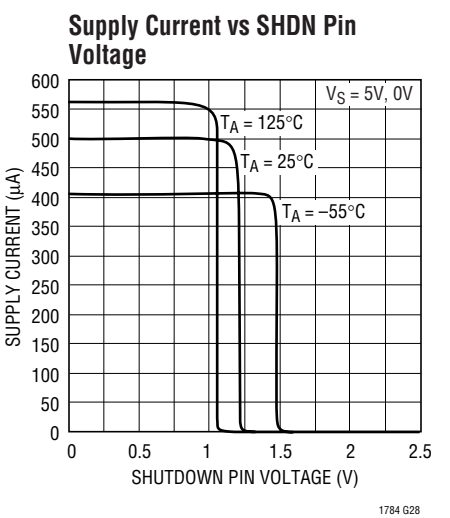

1784 G28

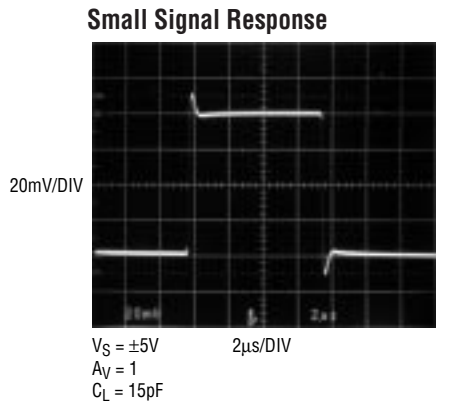
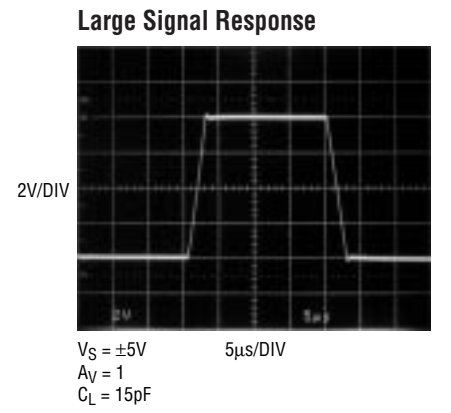



## APPLICATIONS INFORMATION

### Supply Voltage

The positive supply pin of the LT1784 should be bypassed with a small capacitor (typically 0.1 $\mu$ F) within an inch of the pin. When driving heavy loads, an additional 4.7 $\mu$ F electrolytic capacitor should be used. When using split supplies the same is true for the negative supply pin.

The LT1784 is protected against reverse battery voltages up to 18V. In the event a reverse battery condition occurs the supply current is less than 1nA.

### Inputs

The LT1784 has two input stages, NPN and PNP (see the Simplified Schematic), resulting in three distinct operating regions as shown in the “Input Bias Current vs Common Mode” Typical Performance Characteristic Curve.

For input voltages about 1V or more below  $V^+$ , the PNP input stage is active and the input bias current is typically  $-250$ nA. When the input common mode voltage is within 0.6V of the positive rail, the NPN stage is operating and the input bias current is typically 500nA. Increases in temperature will cause the voltage at which operation switches from the PNP input stage to the NPN input stage to move towards  $V^+$ . The input offset voltage of the NPN stage is untrimmed and is typically 3mV.

A Schottky diode in the collector of the input transistors, along with special geometries for these NPN transistors, allow the LT1784 to operate with either or both of its inputs above  $V^+$ . At about 0.3V above  $V^+$ , the NPN input transistors is fully saturated and the input bias current is typically 200 $\mu$ A at room temperature. The input offset voltage is typically 3mV when operating above  $V^+$ . The LT1784 will operate with inputs 18V above  $V^-$  regardless of  $V^+$ .

The inputs are protected against excursions as much as 10V below  $V^-$  by an internal 1k resistor in series with each input and a diode from the input to the negative supply. The input stage of the LT1784 incorporates phase reversal protection to prevent the output from phase reversing for inputs up to 9V below  $V^-$ . There are no clamping diodes between the inputs and the maximum differential input voltage is 18V.

### Output

The output of the LT1784 can swing to within 80mV of the positive rail and within 4mV of the negative rail with no load. When monitoring input voltages within 80mV of the positive rail or within 4mV of the negative rail, gain should be taken to keep the output from clipping. The LT1784 can typically sink and source over 25mA at  $\pm 5$ V supplies, sourcing current is reduced to 7.5mA at 3V total supplies as noted in the electrical characteristics.

The LT1784 is internally compensated to drive at least 400pF of capacitance under any output loading conditions. A 0.22 $\mu$ F capacitor in series with a 150 $\Omega$  resistor between the output and ground will compensate these amplifiers for larger capacitive loads, up to 10,000pF at all output currents.

### Distortion

There are two main contributors to distortion in op amps: output crossover distortion as the output transitions from sourcing to sinking current, and distortion caused by nonlinear common mode rejection. If the op amp is operating inverting, there is no common mode induced distortion. If the op amp is operating in the PNP input stage (input not within 1V of  $V^+$ ), the CMRR is very good, typically 95dB. When the LT1784 switches between input stages, there is significant nonlinearity in the CMRR. Lower load resistance increases the output crossover distortion but has no effect on the input stage transition distortion. For lowest distortion, the LT1784 should be operated single supply, with the output always sourcing current and with the input voltage swing between ground and ( $V^+ - 1$ V). See Typical Performance Characteristics Curve, “Total Harmonic Distortion + Noise vs Output Voltage Amplitude.”

### Gain

The open-loop gain is almost independent of load when the output is sourcing current. This optimizes performance in single supply applications where the load is returned to ground. The Typical Performance Characteristic Curve “Open-Loop Gain” for various loads shows the details.

# LT1784

## APPLICATIONS INFORMATION

### Shutdown

The 6-lead part includes a shutdown feature that disables the part, reducing quiescent current and making the output high impedance. The part can be shut down by

bringing the SHDN pin 1.2V or more above  $V^-$ . When shut down, the supply current is less than  $1\mu\text{A}$  ( $V^- \leq V_{\text{OUT}} \leq V^+$ ). In normal operation, the SHDN pin can be tied to  $V^-$  or left floating. See Typical Performance Characteristics Curve, "Supply Current vs SHDN pin Voltage."

## TYPICAL APPLICATIONS

### Negative Rectifier

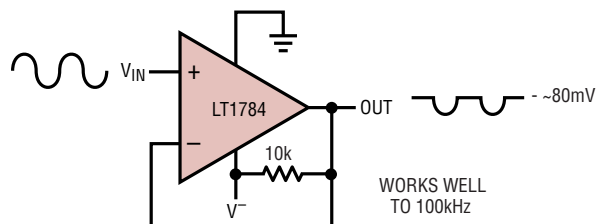

### Adjustable Clamp

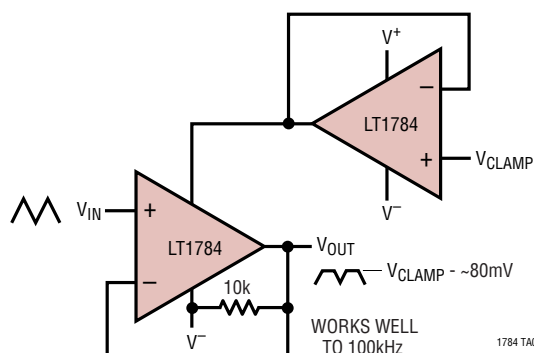

## SIMPLIFIED SCHEMATIC

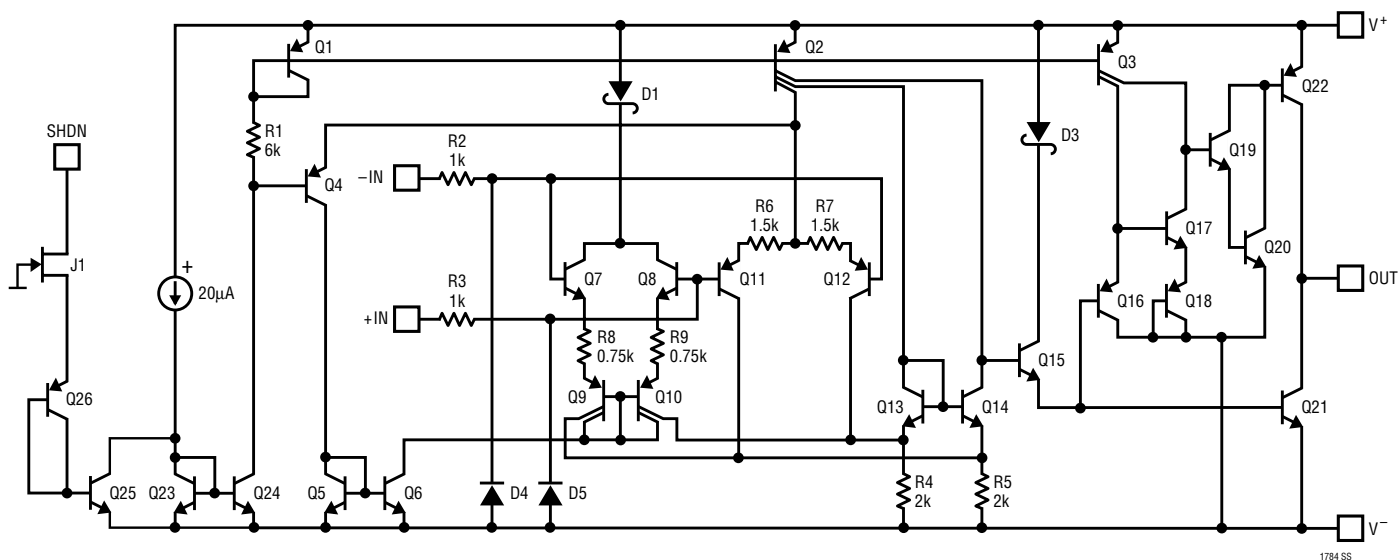

## PACKAGE DESCRIPTION

### S5 Package 5-Lead Plastic SOT-23

(Reference LTC DWG # 05-08-1633)

(Reference LTC DWG # 05-08-1635)

	SOT-23 (Original)	SOT-23 (ThinSOT)
A	.90 - 1.45 (.035 - .057)	1.00 MAX (.039 MAX)
A1	.00 - .15 (.00 - .006)	.01 - .10 (.0004 - .004)
A2	.90 - 1.30 (.035 - .051)	.80 - .90 (.031 - .035)
L	.35 - .55 (.014 - .021)	.30 - .50 REF (.012 - .019 REF)

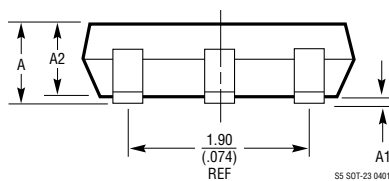
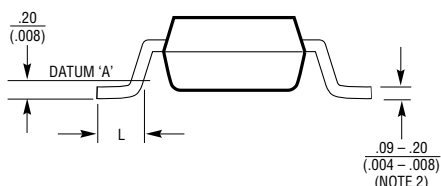
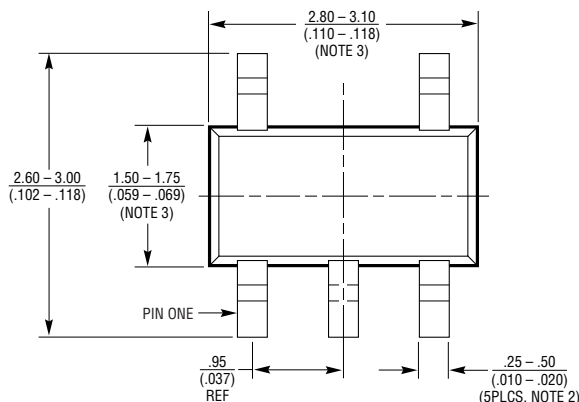

NOTE:

1. CONTROLLING DIMENSION: MILLIMETERS
2. DIMENSIONS ARE IN  $\frac{\text{MILLIMETERS}}{\text{INCHES}}$
3. DRAWING NOT TO SCALE
4. DIMENSIONS ARE INCLUSIVE OF PLATING
5. DIMENSIONS ARE EXCLUSIVE OF MOLD FLASH AND METAL BURR
6. MOLD FLASH SHALL NOT EXCEED .254mm
7. PACKAGE EIAJ REFERENCE IS:  
SC-74A (EIAJ) FOR ORIGINAL  
JEDEC MO-193 FOR THIN

### S6 Package 6-Lead Plastic SOT-23

(Reference LTC DWG # 05-08-1634)

(Reference LTC DWG # 05-08-1636)

	SOT-23 (Original)	SOT-23 (ThinSOT)
A	.90 - 1.45 (.035 - .057)	1.00 MAX (.039 MAX)
A1	.00 - 0.15 (.00 - .006)	.01 - .10 (.0004 - .004)
A2	.90 - 1.30 (.035 - .051)	.80 - .90 (.031 - .035)
L	.35 - .55 (.014 - .021)	.30 - .50 REF (.012 - .019 REF)

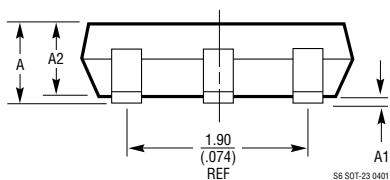
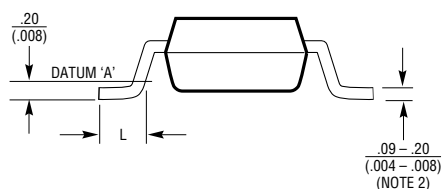
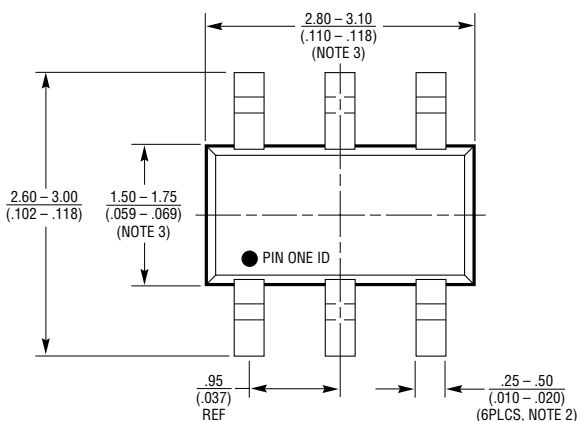

NOTE:

1. CONTROLLING DIMENSION: MILLIMETERS
2. DIMENSIONS ARE IN  $\frac{\text{MILLIMETERS}}{\text{INCHES}}$
3. DRAWING NOT TO SCALE
4. DIMENSIONS ARE INCLUSIVE OF PLATING
5. DIMENSIONS ARE EXCLUSIVE OF MOLD FLASH AND METAL BURR
6. MOLD FLASH SHALL NOT EXCEED .254mm
7. PACKAGE EIAJ REFERENCE IS:  
SC-74A (EIAJ) FOR ORIGINAL  
JEDEC MO-193 FOR THIN

www.DataSheet4U.com

## LT1784

## TYPICAL APPLICATIONS

## Protected Fault Conditions

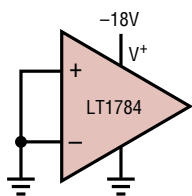

REVERSE BATTERY

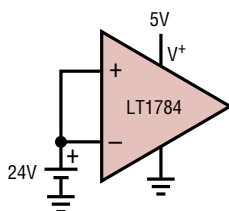

INPUT OVERVOLTAGE

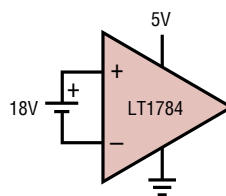

INPUT DIFFERENTIAL VOLTAGE

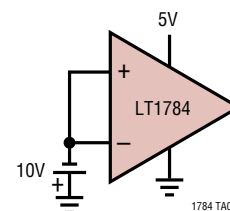

INPUTS BELOW GROUND

## Simple Peak Detector

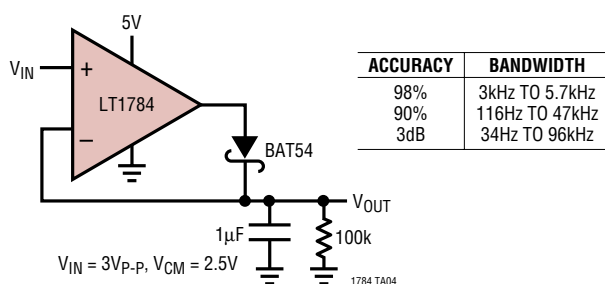

## Single Supply Full Wave Rectifier

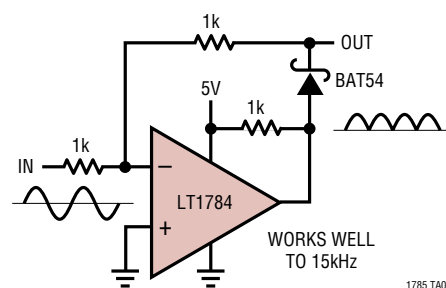

## Simple Polarity Selector

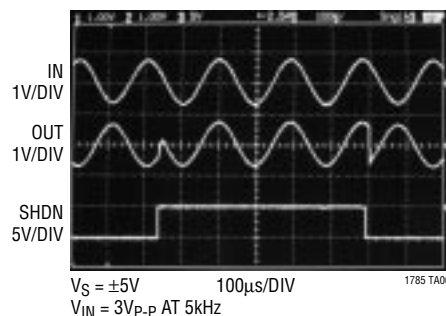
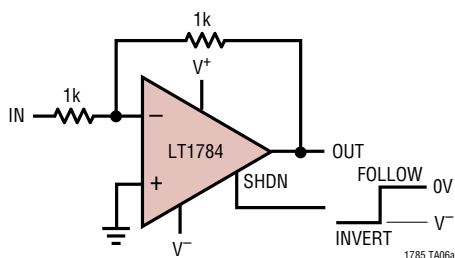

## RELATED PARTS

PART NUMBER	DESCRIPTION	COMMENTS
LT1782	Micropower Over-The-Top Rail-to-Rail In/Out Op Amp in SOT-23	55μA Max Supply Current, 800μV Max Offset Voltage
LT1783	1.25MHz Over-The-Top Rail-to-Rail In/Out Op Amp in SOT-23	300μA Max Supply Current, 800μV Max Offset Voltage
LT1797	10MHz Rail-to-Rail In/Out Op Amp in SOT-23	Unity-Gain Stable, 2.25μV/μs Slew Rate
LT1637	1.1MHz Over-The-Top Rail-to-Rail In/Out Op Amp	Micropower, 0.4V/μs Slew Rate
LT1638/LT1639	Dual/Quad 1.2MHz Over-The-Top Rail-to-Rail In/Out Op Amp	Micropower 230μA Max, 0.4V/μs Slew Rate
LT1880	SOT-23 Pico Amp Input, Precision, Rail-to-Rail Output Op Amp	150μV Offset, 900pA Bias Current

www.DataSheet4U.com