

80MHz, 25V/ μ s Low Power Rail-to-Rail Input and Output Precision Op Amp

FEATURES

- Gain Bandwidth Product: 80MHz
- Input Common Mode Range Includes Both Rails
- Output Swings Rail-to-Rail
- Low Quiescent Current: 2mA Max
- Input Offset Voltage: 350 μ V Max
- Input Bias Current: 250nA Max
- Low Voltage Noise: 8.5nV/ $\sqrt{\text{Hz}}$
- Slew Rate: 25V/ μ s
- Common Mode Rejection: 105dB
- Power Supply Rejection: 97dB
- Open-Loop Gain: 85V/mV
- Available in the 8-Pin SO and 5-Pin Low Profile (1mm) ThinSOT™ Packages
- Operating Temperature Range: -40°C to 85°C

APPLICATIONS

- Low Voltage, High Frequency Signal Processing
- Driving A/D Converters
- Rail-to-Rail Buffer Amplifiers
- Active Filters
- Video Line Driver

DESCRIPTION

The LT[®]1800 is a low power, high speed rail-to-rail input and output operational amplifier with excellent DC performance. The LT1800 features reduced supply current, lower input offset voltage, lower input bias current and higher DC gain than other devices with comparable bandwidth.

The LT1800 has an input range that includes both supply rails and an output that swings within 20mV of either supply rail to maximize the signal dynamic range in low supply applications.

The LT1800 maintains its performance for supplies from 2.3V to 12.6V and is specified at 3V, 5V and \pm 5V supplies. The inputs can be driven beyond the supplies without damage or phase reversal of the output.

The LT1800 is available in the 8-pin SO package with the standard op amp pinout and in the 5-pin SOT-23 package. For dual and quad versions of the LT1800, see the LT1801/LT1802 data sheet. The LT1800 can be used as a plug-in replacement for many op amps to improve input/output range and performance.

LT, LTC and LT are registered trademarks of Linear Technology Corporation. ThinSOT is a trademark of Linear Technology Corporation.

TYPICAL APPLICATION

Single Supply 1A Laser Driver Amplifier

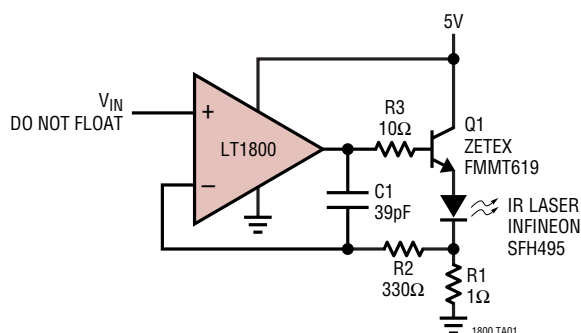

Laser Driver Amplifier
500mA Pulse Response

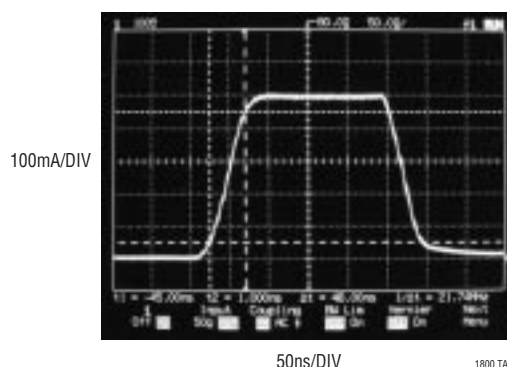

ABSOLUTE MAXIMUM RATINGS (Note 1)

| | | | |
|---|---------------|--|----------------|
| Total Supply Voltage (V_S^- to V_S^+) | 12.6V | Specified Temperature Range (Note 5) ... | -40°C to 85°C |
| Input Current (Note 2) | ± 10 mA | Junction Temperature | 150°C |
| Output Short-Circuit Duration (Note 3) | Indefinite | Storage Temperature Range | -65°C to 150°C |
| Operating Temperature Range (Note 4) .. | -40°C to 85°C | Lead Temperature (Soldering, 10 sec) | 300°C |

PACKAGE/ORDER INFORMATION

| | | | |
|--|------------------------|--|------------------------|
| | ORDER PART NUMBER | | ORDER PART NUMBER |
| | LT1800CS8 LT1800IS8 | | LT1800CS5 LT1800IS5 |
| | S8 PART MARKING | | S5 PART MARKING |
| | 1800 1800I | | LTRN LTRP |

Consult LTC Marketing for parts specified with wider operating temperature ranges.

ELECTRICAL CHARACTERISTICS

$T_A = 25^\circ\text{C}$, $V_S = 5\text{V}$, 0V ; $V_S = 3\text{V}$, 0V ; $V_{CM} = V_{OUT} = \text{half supply}$, unless otherwise noted.

| SYMBOL | PARAMETER | CONDITIONS | MIN | TYP | MAX | UNITS |
|-----------------|------------------------------|---|-----|-----|-------|------------------------------|
| V_{OS} | Input Offset Voltage | $V_{CM} = 0\text{V}$ | | 75 | 350 | μV |
| | | $V_{CM} = 0\text{V}$ (SOT-23) | | 300 | 750 | μV |
| | | $V_{CM} = V_S$ | | 0.5 | 3 | mV |
| | | $V_{CM} = V_S$ (SOT-23) | | 0.7 | 3.5 | mV |
| ΔV_{OS} | Input Offset Shift | $V_{CM} = 0\text{V}$ to $V_S - 1.5\text{V}$ | | 20 | 180 | μV |
| I_B | Input Bias Current | $V_{CM} = 1\text{V}$ | | 25 | 250 | nA |
| | | $V_{CM} = V_S$ | | 500 | 1500 | nA |
| I_{OS} | Input Offset Current | $V_{CM} = 1\text{V}$ | | 25 | 200 | nA |
| | | $V_{CM} = V_S$ | | 25 | 200 | nA |
| | Input Noise Voltage | 0.1Hz to 10Hz | | 1.4 | | μV_{p-p} |
| e_n | Input Noise Voltage Density | $f = 10\text{kHz}$ | | 8.5 | | $\text{nV}/\sqrt{\text{Hz}}$ |
| i_n | Input Noise Current Density | $f = 10\text{kHz}$ | | 1 | | $\text{pA}/\sqrt{\text{Hz}}$ |
| C_{IN} | Input Capacitance | $f = 100\text{kHz}$ | | 2 | | pF |
| A_{VOL} | Large-Signal Voltage Gain | $V_S = 5\text{V}$, $V_O = 0.5\text{V}$ to 4.5V , $R_L = 1\text{k}$ at $V_S/2$ | 35 | 85 | | V/mV |
| | | $V_S = 5\text{V}$, $V_O = 1\text{V}$ to 4V , $R_L = 100\Omega$ at $V_S/2$ | 3.5 | 8 | | V/mV |
| | | $V_S = 3\text{V}$, $V_O = 0.5\text{V}$ to 2.5V , $R_L = 1\text{k}$ at $V_S/2$ | 30 | 85 | | V/mV |
| CMRR | Common Mode Rejection Ratio | $V_S = 5\text{V}$, $V_{CM} = 0\text{V}$ to 3.5V | 85 | 105 | | dB |
| | | $V_S = 3\text{V}$, $V_{CM} = 0\text{V}$ to 1.5V | 78 | 97 | | dB |
| | Input Common Mode Range | | 0 | | V_S | V |
| PSRR | Power Supply Rejection Ratio | $V_S = 2.5\text{V}$ to 10V , $V_{CM} = 0\text{V}$ | 80 | 97 | | dB |
| | | Minimum Supply Voltage (Note 6) | | 2.3 | 2.5 | |

ELECTRICAL CHARACTERISTICS

T_A = 25°C, V_S = 5V, 0V; V_S = 3V, 0V; V_{CM} = V_{OUT} = half supply, unless otherwise noted.

| SYMBOL | PARAMETER | CONDITIONS | MIN | TYP | MAX | UNITS |
|-----------------|------------------------------------|--|-----|------|-----|-------|
| V _{OL} | Output Voltage Swing Low (Note 7) | No Load | | 12 | 50 | mV |
| | | I _{SINK} = 5mA | | 80 | 160 | mV |
| | | I _{SINK} = 20mA | | 225 | 450 | mV |
| V _{OH} | Output Voltage Swing High (Note 7) | No Load | | 16 | 60 | mV |
| | | I _{SOURCE} = 5mA | | 120 | 250 | mV |
| | | I _{SOURCE} = 20mA | | 450 | 750 | mV |
| I _{SC} | Short-Circuit Current | V _S = 5V | 20 | 45 | | mA |
| | | V _S = 3V | 20 | 40 | | mA |
| I _S | Supply Current per Amplifier | | | 1.6 | 2 | mA |
| GBW | Gain Bandwidth Product | Frequency = 2MHz | 40 | 80 | | MHz |
| SR | Slew Rate | V _S = 5V, A _V = -1, R _L = 1k, V _O = 4V | 13 | 25 | | V/μs |
| FPBW | Full Power Bandwidth | V _S = 5V, V _{OUT} = 4V _{P-P} | | 2 | | MHz |
| HD | Harmonic Distortion | V _S = 5V, A _V = 1, R _L = 1k, V _O = 2V _{P-P} , f _C = 500kHz | | -75 | | dBc |
| t _S | Settling Time | 0.01%, V _S = 5V, V _{STEP} = 2V, A _V = 1, R _L = 1k | | 250 | | ns |
| ΔG | Differential Gain (NTSC) | V _S = 5V, A _V = +2, R _L = 150Ω | | 0.35 | | % |
| Δθ | Differential Phase (NTSC) | V _S = 5V, A _V = +2, R _L = 150Ω | | 0.4 | | Deg |

The ● denotes the specifications which apply over the temperature range of 0°C ≤ T_A ≤ 70°C. V_S = 5V, 0V; V_S = 3V, 0V; V_{CM} = V_{OUT} = half supply, unless otherwise noted.

| SYMBOL | PARAMETER | CONDITIONS | MIN | TYP | MAX | UNITS |
|--------------------|-------------------------------------|---|-----|-----|----------------|-------|
| V _{OS} | Input Offset Voltage | V _{CM} = 0V | ● | 125 | 500 | μV |
| | | V _{CM} = 0V (SOT-23) | ● | 300 | 1250 | μV |
| | | V _{CM} = V _S | ● | 0.6 | 3.5 | mV |
| | | V _{CM} = V _S (SOT-23) | ● | 0.7 | 3.75 | mV |
| ΔV _{OS} | Input Offset Shift | V _{CM} = 0V to V _S - 1.5V | ● | 30 | 275 | μV |
| V _{OS} TC | Input Offset Voltage Drift (Note 8) | | ● | 1.5 | 5 | μV/°C |
| I _B | Input Bias Current | V _{CM} = 1V | ● | 50 | 300 | nA |
| | | V _{CM} = V _S - 0.2V | ● | 550 | 1750 | nA |
| I _{OS} | Input Offset Current | V _{CM} = 1V | ● | 25 | 250 | nA |
| | | V _{CM} = V _S - 0.2V | ● | 25 | 250 | nA |
| A _{VOL} | Large-Signal Voltage Gain | V _S = 5V, V _O = 0.5V to 4.5V, R _L = 1k at V _S /2 | ● | 30 | 75 | V/mV |
| | | V _S = 5V, V _O = 1V to 4V, R _L = 100Ω at V _S /2 | ● | 3 | 6 | V/mV |
| | | V _S = 3V, V _O = 0.5V to 2.5V, R _L = 1k at V _S /2 | ● | 25 | 75 | V/mV |
| CMRR | Common Mode Rejection Ratio | V _S = 5V, V _{CM} = 0V to 3.5V | ● | 82 | 101 | dB |
| | | V _S = 3V, V _{CM} = 0V to 1.5V | ● | 74 | 93 | dB |
| | Input Common Mode Range | | ● | 0 | V _S | V |
| PSRR | Power Supply Rejection Ratio | V _S = 2.5V to 10V, V _{CM} = 0V | ● | 74 | 91 | dB |
| | | Minimum Supply Voltage (Note 6) | ● | 2.3 | 2.5 | V |
| V _{OL} | Output Voltage Swing Low (Note 7) | No Load | ● | 14 | 60 | mV |
| | | I _{SINK} = 5mA | ● | 100 | 200 | mV |
| | | I _{SINK} = 20mA | ● | 300 | 550 | mV |
| V _{OH} | Output Voltage Swing High (Note 7) | No Load | ● | 25 | 80 | mV |
| | | I _{SOURCE} = 5mA | ● | 150 | 300 | mV |
| | | I _{SOURCE} = 20mA | ● | 600 | 950 | mV |
| I _{SC} | Short-Circuit Current | V _S = 5V | ● | 20 | 40 | mA |
| | | V _S = 3V | ● | 20 | 30 | mA |
| I _S | Supply Current per Amplifier | | ● | 2 | 2.75 | mA |
| GBW | Gain Bandwidth Product | Frequency = 2MHz | ● | 35 | 75 | MHz |
| SR | Slew Rate | V _S = 5V, A _V = -1, R _L = 1k, V _O = 4V _{P-P} | ● | 11 | 22 | V/μs |

ELECTRICAL CHARACTERISTICS The ● denotes the specifications which apply over the temperature range of $-40^{\circ}\text{C} \leq T_A \leq 85^{\circ}\text{C}$. $V_S = 5\text{V}$, 0V ; $V_S = 3\text{V}$, 0V ; $V_{\text{CM}} = V_{\text{OUT}} = \text{half supply}$, unless otherwise noted. (Note 5)

| SYMBOL | PARAMETER | CONDITIONS | MIN | TYP | MAX | UNITS |
|------------------------|-------------------------------------|---|-----|------|-------|--------------------------------|
| V_{OS} | Input Offset Voltage | $V_{\text{CM}} = 0\text{V}$ | ● | 175 | 700 | μV |
| | | $V_{\text{CM}} = 0\text{V}$ (SOT-23) | ● | 400 | 2000 | μV |
| | | $V_{\text{CM}} = V_S$ | ● | 0.75 | 4 | mV |
| | | $V_{\text{CM}} = V_S$ (SOT-23) | ● | 0.9 | 4 | mV |
| ΔV_{OS} | Input Offset Shift | $V_{\text{CM}} = 0\text{V}$ to $V_S - 1.5\text{V}$ | ● | 30 | 300 | μV |
| $V_{\text{OS TC}}$ | Input Offset Voltage Drift (Note 8) | | ● | 1.5 | 5 | $\mu\text{V}/^{\circ}\text{C}$ |
| I_B | Input Bias Current | $V_{\text{CM}} = 1\text{V}$ | ● | 50 | 400 | nA |
| | | $V_{\text{CM}} = V_S - 0.2\text{V}$ | ● | 600 | 2000 | nA |
| I_{OS} | Input Offset Current | $V_{\text{CM}} = 1\text{V}$ | ● | 25 | 300 | nA |
| | | $V_{\text{CM}} = V_S - 0.2\text{V}$ | ● | 25 | 300 | nA |
| A_{VOL} | Large-Signal Voltage Gain | $V_S = 5\text{V}$, $V_0 = 0.5\text{V}$ to 4.5V , $R_L = 1\text{k}$ at $V_S/2$ | ● | 25 | 65 | V/mV |
| | | $V_S = 5\text{V}$, $V_0 = 1.5\text{V}$ to 3.5V , $R_L = 100\Omega$ at $V_S/2$ | ● | 2.5 | 6 | V/mV |
| | | $V_S = 3\text{V}$, $V_0 = 0.5\text{V}$ to 2.5V , $R_L = 1\text{k}$ at $V_S/2$ | ● | 20 | 65 | V/mV |
| CMRR | Common Mode Rejection Ratio | $V_S = 5\text{V}$, $V_{\text{CM}} = 0\text{V}$ to 3.5V | ● | 81 | 101 | dB |
| | | $V_S = 3\text{V}$, $V_{\text{CM}} = 0\text{V}$ to 1.5V | ● | 73 | 93 | dB |
| | Input Common Mode Range | | ● | 0 | V_S | V |
| PSRR | Power Supply Rejection Ratio | $V_S = 2.5\text{V}$ to 10V , $V_{\text{CM}} = 0\text{V}$ | ● | 73 | 90 | dB |
| | | Minimum Supply Voltage (Note 6) | ● | 2.3 | 2.5 | V |
| V_{OL} | Output Voltage Swing Low (Note 7) | No Load | ● | 15 | 70 | mV |
| | | $I_{\text{SINK}} = 5\text{mA}$ | ● | 105 | 210 | mV |
| | | $I_{\text{SINK}} = 10\text{mA}$ | ● | 170 | 400 | mV |
| V_{OH} | Output Voltage Swing High (Note 7) | No Load | ● | 25 | 90 | mV |
| | | $I_{\text{SOURCE}} = 5\text{mA}$ | ● | 150 | 350 | mV |
| | | $I_{\text{SOURCE}} = 10\text{mA}$ | ● | 300 | 700 | mV |
| I_{SC} | Short-Circuit Current | $V_S = 5\text{V}$ | ● | 12.5 | 30 | mA |
| | | $V_S = 3\text{V}$ | ● | 12.5 | 30 | mA |
| I_S | Supply Current per Amplifier | | ● | 2.1 | 3 | mA |
| GBW | Gain Bandwidth Product | Frequency = 2MHz | ● | 30 | 70 | MHz |
| SR | Slew Rate | $V_S = 5\text{V}$, $A_V = -1$, $R_L = 1\text{k}$, $V_0 = 4\text{V}$ | ● | 10 | 18 | V/ μs |

$T_A = 25^{\circ}\text{C}$, $V_S = \pm 5\text{V}$, $V_{\text{CM}} = 0\text{V}$, $V_{\text{OUT}} = 0\text{V}$, unless otherwise noted.

| SYMBOL | PARAMETER | CONDITIONS | MIN | TYP | MAX | UNITS |
|------------------------|-----------------------------|--|-----|-----|------|----------------------------|
| V_{OS} | Input Offset Voltage | $V_{\text{CM}} = V_S^-$ | | 150 | 500 | μV |
| | | $V_{\text{CM}} = V_S^-$ (SOT-23) | | 400 | 1000 | μV |
| | | $V_{\text{CM}} = V_S^+$ | | 0.7 | 3.5 | mV |
| | | $V_{\text{CM}} = V_S^+$ (SOT-23) | | 1 | 4.5 | mV |
| ΔV_{OS} | Input Offset Shift | $V_{\text{CM}} = V_S^-$ to $V_S^+ - 1.5\text{V}$ | | 30 | 475 | μV |
| I_B | Input Bias Current | $V_{\text{CM}} = V_S^- + 1\text{V}$ | | 25 | 350 | nA |
| | | $V_{\text{CM}} = V_S^+$ | | 400 | 1500 | nA |
| I_{OS} | Input Offset Current | $V_{\text{CM}} = V_S^- + 1\text{V}$ | | 20 | 250 | nA |
| | | $V_{\text{CM}} = V_S^+$ | | 20 | 250 | nA |
| | Input Noise Voltage | 0.1Hz to 10Hz | | 1.4 | | $\mu\text{V}_{\text{P-P}}$ |
| e_n | Input Noise Voltage Density | $f = 10\text{kHz}$ | | 8.5 | | nV/ $\sqrt{\text{Hz}}$ |
| i_n | Input Noise Current Density | $f = 10\text{kHz}$ | | 1 | | pA/ $\sqrt{\text{Hz}}$ |
| C_{IN} | Input Capacitance | $f = 100\text{kHz}$ | | 2 | | pF |

ELECTRICAL CHARACTERISTICS

T_A = 25°C, V_S = ±5V, V_{CM} = 0V, V_{OUT} = 0V, unless otherwise noted.

| SYMBOL | PARAMETER | CONDITIONS | MIN | TYP | MAX | UNITS |
|------------------|------------------------------------|---|-----------------------------|------|-----------------------------|-------|
| A _{VOL} | Large-Signal Voltage Gain | V _O = -4V to 4V, R _L = 1k | 25 | 70 | | V/mV |
| | | V _O = -2V to 2V, R _L = 100Ω | 2.5 | 7 | | V/mV |
| CMRR | Common Mode Rejection Ratio | V _{CM} = V _S ⁻ to 3.5V | 85 | 109 | | dB |
| | Input Common Mode Range | | V _S ⁻ | | V _S ⁺ | V |
| PSRR | Power Supply Rejection Ratio | V _S ⁺ = 2.5V to 10V, V _S ⁻ = 0V | 80 | 97 | | dB |
| V _{OL} | Output Voltage Swing Low (Note 7) | No Load | | 15 | 60 | mV |
| | | I _{SINK} = 5mA | | 85 | 170 | mV |
| | | I _{SINK} = 20mA | | 225 | 450 | mV |
| V _{OH} | Output Voltage Swing High (Note 7) | No Load | | 17 | 70 | mV |
| | | I _{SOURCE} = 5mA | | 130 | 260 | mV |
| | | I _{SOURCE} = 20mA | | 450 | 750 | mV |
| I _{SC} | Short-Circuit Current | | 30 | 50 | | mA |
| I _S | Supply Current per Amplifier | | | 1.8 | 2.75 | mA |
| GBW | Gain Bandwidth Product | Frequency = 2MHz | | 70 | | MHz |
| SR | Slew Rate | A _V = -1, R _L = 1k, V _O = ±4V, Measured at V _O = ±2V | | 23 | | V/μs |
| FPBW | Full Power Bandwidth | V _O = 8V _{P-P} | | 0.9 | | MHz |
| HD | Harmonic Distortion | A _V = 1, R _L = 1k, V _O = 2V _{P-P} , f _C = 500kHz | | -75 | | dBc |
| t _S | Settling Time | 0.01%, V _{STEP} = 5V, A _V = 1V, R _L = 1k | | 300 | | ns |
| ΔG | Differential Gain (NTSC) | A _V = +2, R _L = 150Ω | | 0.35 | | % |
| Δθ | Differential Phase (NTSC) | A _V = +2, R _L = 150Ω | | 0.2 | | Deg |

The ● denotes the specifications which apply over the temperature range of 0°C ≤ T_A ≤ 70°C. V_S = ±5V, V_{CM} = 0V, V_{OUT} = 0V, unless otherwise noted.

| SYMBOL | PARAMETER | CONDITIONS | MIN | TYP | MAX | UNITS |
|--------------------|-------------------------------------|---|-----|-----------------------------|-----------------------------|-------|
| V _{OS} | Input Offset Voltage | V _{CM} = V _S ⁻ | ● | 200 | 800 | μV |
| | | V _{CM} = V _S ⁻ (SOT-23) | ● | 450 | 1500 | μV |
| | | V _{CM} = V _S ⁺ | ● | 0.75 | 4 | mV |
| | | V _{CM} = V _S ⁺ (SOT-23) | ● | 1 | 5 | mV |
| ΔV _{OS} | Input Offset Shift | V _{CM} = V _S ⁻ to V _S ⁺ - 1.5V | ● | 45 | 675 | μV |
| V _{OS} TC | Input Offset Voltage Drift (Note 8) | | ● | 1.5 | 5 | μV/°C |
| I _B | Input Bias Current | V _{CM} = V _S ⁻ + 1V | ● | 30 | 400 | nA |
| | | V _{CM} = V _S ⁺ - 0.2V | ● | 450 | 1750 | nA |
| I _{OS} | Input Offset Current | V _{CM} = V _S ⁻ + 1V | ● | 25 | 300 | nA |
| | | V _{CM} = V _S ⁺ - 0.2V | ● | 25 | 300 | nA |
| A _{VOL} | Large-Signal Voltage Gain | V _O = -4V to 4V, R _L = 1k | ● | 20 | 55 | V/mV |
| | | V _O = -2V to 2V, R _L = 100Ω | ● | 2 | 5 | V/mV |
| CMRR | Common Mode Rejection Ratio | V _{CM} = V _S ⁻ to 3.5V | ● | 82 | 105 | dB |
| | Input Common Mode Range | | ● | V _S ⁻ | V _S ⁺ | V |
| PSRR | Power Supply Rejection Ratio | V _S ⁺ = 2.5V to 10V, V _S ⁻ = 0V | ● | 74 | 91 | dB |
| V _{OL} | Output Voltage Swing Low (Note 7) | No Load | ● | 17 | 70 | mV |
| | | I _{SINK} = 5mA | ● | 105 | 210 | mV |
| | | I _{SINK} = 20mA | ● | 250 | 575 | mV |
| V _{OH} | Output Voltage Swing High (Note 7) | No Load | ● | 25 | 90 | mV |
| | | I _{SOURCE} = 5mA | ● | 150 | 310 | mV |
| | | I _{SOURCE} = 20mA | ● | 600 | 975 | mV |

ELECTRICAL CHARACTERISTICS The ● denotes the specifications which apply over the temperature range of $0^{\circ}\text{C} \leq T_A \leq 70^{\circ}\text{C}$. $V_S = \pm 5\text{V}$, $V_{CM} = 0\text{V}$, $V_{OUT} = 0\text{V}$, unless otherwise noted.

| SYMBOL | PARAMETER | CONDITIONS | | MIN | TYP | MAX | UNITS |
|----------|------------------------------|--|---|-----|-----|-----|------------------|
| I_{SC} | Short-Circuit Current | | ● | 25 | 45 | | mA |
| I_S | Supply Current per Amplifier | | ● | | 2.4 | 3.5 | mA |
| GBW | Gain Bandwidth Product | Frequency = 2MHz | ● | | 70 | | MHz |
| SR | Slew Rate | $A_V = -1$, $R_L = 1\text{k}$, $V_O = \pm 4\text{V}$, Measured at $V_O = \pm 2\text{V}$ | ● | | 20 | | V/ μs |

The ● denotes the specifications which apply over the temperature range of $-40^{\circ}\text{C} \leq T_A \leq 85^{\circ}\text{C}$. $V_S = \pm 5\text{V}$, $V_{CM} = 0\text{V}$, $V_{OUT} = 0\text{V}$, unless otherwise noted.

| SYMBOL | PARAMETER | CONDITIONS | | MIN | TYP | MAX | UNITS |
|-----------------|-------------------------------------|--|---|---------|------|---------|--------------------------------|
| V_{OS} | Input Offset Voltage | $V_{CM} = V_S^-$ | ● | | 350 | 900 | μV |
| | | $V_{CM} = V_S^-$ (SOT-23) | ● | | 500 | 2250 | μV |
| | | $V_{CM} = V_S^+$ | ● | | 0.75 | 4.5 | mV |
| | | $V_{CM} = V_S^+$ (SOT-23) | ● | | 1 | 5.5 | mV |
| ΔV_{OS} | Input Offset Shift | $V_{CM} = V_S^-$ to $V_S^+ - 1.5\text{V}$ | ● | | 50 | 750 | μV |
| $V_{OS\ TC}$ | Input Offset Voltage Drift (Note 8) | | ● | | 1.5 | 5 | $\mu\text{V}/^{\circ}\text{C}$ |
| I_B | Input Bias Current | $V_{CM} = V_S^- + 1\text{V}$ | ● | | 50 | 450 | nA |
| | | $V_{CM} = V_S^+ - 0.2\text{V}$ | ● | | 450 | 2000 | nA |
| I_{OS} | Input Offset Current | $V_{CM} = V_S^- + 1\text{V}$ | ● | | 25 | 350 | nA |
| | | $V_{CM} = V_S^+ - 0.2\text{V}$ | ● | | 25 | 350 | nA |
| A_{VOL} | Large-Signal Voltage Gain | $V_O = -4\text{V}$ to 4V , $R_L = 1\text{k}$ | ● | 16 | 55 | | V/mV |
| | | $V_O = -1\text{V}$ to 1V , $R_L = 100\Omega$ | ● | 2 | 5 | | V/mV |
| CMRR | Common Mode Rejection Ratio | $V_{CM} = V_S^-$ to 3.5V | ● | 81 | 104 | | dB |
| | Input Common Mode Range | | ● | V_S^- | | V_S^+ | V |
| PSRR | Power Supply Rejection Ratio | $V_S^+ = 2.5\text{V}$ to 10V , $V_S^- = 0\text{V}$ | ● | 73 | 90 | | dB |
| V_{OL} | Output Voltage Swing Low (Note 7) | No Load | ● | | 15 | 80 | mV |
| | | $I_{SINK} = 5\text{mA}$ | ● | | 105 | 220 | mV |
| | | $I_{SINK} = 10\text{mA}$ | ● | | 170 | 400 | mV |
| V_{OH} | Output Voltage Swing High (Note 7) | No Load | ● | | 25 | 100 | mV |
| | | $I_{SOURCE} = 5\text{mA}$ | ● | | 150 | 350 | mV |
| | | $I_{SOURCE} = 10\text{mA}$ | ● | | 300 | 700 | mV |
| I_{SC} | Short-Circuit Current | | ● | 12.5 | 30 | mA | |
| I_S | Supply Current per Amplifier | | ● | | 2.6 | 4 | mA |
| GBW | Gain Bandwidth Product | Frequency = 2MHz | ● | | 65 | | MHz |
| SR | Slew Rate | $A_V = -1$, $R_L = 1\text{k}$, $V_O = \pm 4\text{V}$, Measured at $V_O = \pm 2\text{V}$ | ● | | 15 | | V/ μs |

Note 1: Absolute Maximum Ratings are those values beyond which the life of the device may be impaired.

Note 2: The inputs are protected by back-to-back diodes and by ESD diodes to the supply rails. If the differential input voltage exceeds 1.4V or either input goes outside the rails, the input current should be limited to less than 10mA.

Note 3: A heat sink may be required to keep the junction temperature below the absolute maximum rating when the output is shorted indefinitely.

Note 4: The LT1800C/LT1800I are guaranteed functional over the temperature range of -40°C to 85°C .

Note 5: The LT1800C is guaranteed to meet specified performance from 0°C to 70°C . The LT1800C is designed, characterized and expected to meet specified performance from -40°C to 85°C but is not tested or QA sampled at these temperatures. The LT1800I is guaranteed to meet specified performance from -40°C to 85°C .

Note 6: Minimum supply voltage is guaranteed by power supply rejection ratio test.

Note 7: Output voltage swings are measured between the output and power supply rails.

Note 8: This parameter is not 100% tested.

TYPICAL PERFORMANCE CHARACTERISTICS

**V_{OS} Distribution, $V_{CM} = 0V$
(SO-8, PNP Stage)**

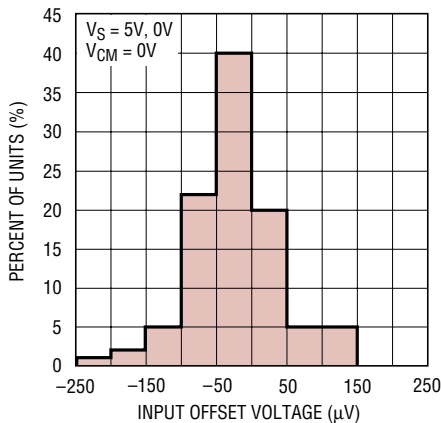

1800 G01

**V_{OS} Distribution, $V_{CM} = 5V$
(SO-8, NPN Stage)**

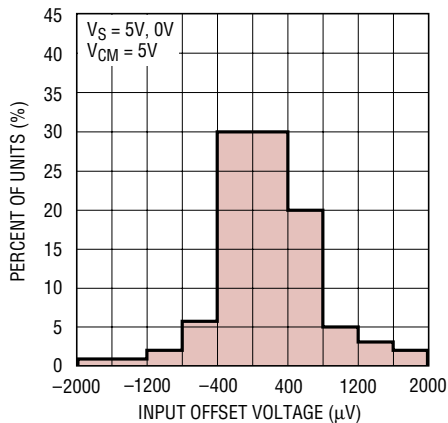

1800 G02

**V_{OS} Distribution, $V_{CM} = 0V$
(SOT-23, PNP Stage)**

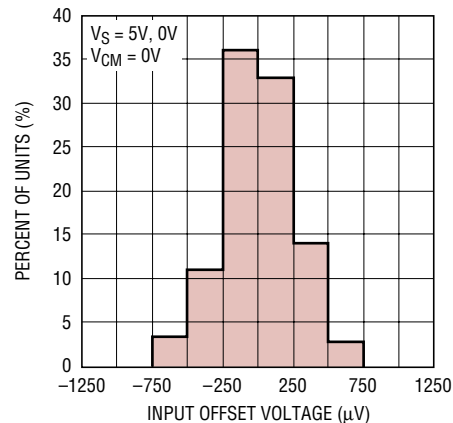

1800 G38

**V_{OS} Distribution, $V_{CM} = 5V$
(SOT-23, NPN Stage)**

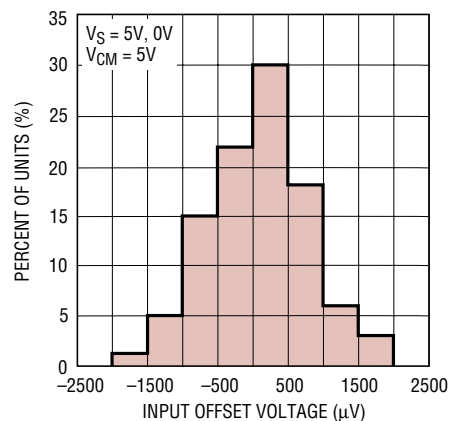

1800 G39

Supply Current vs Supply Voltage

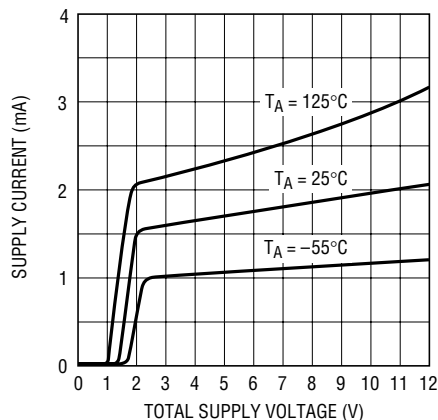

1800 G03

Offset Voltage vs Input Common Mode Voltage

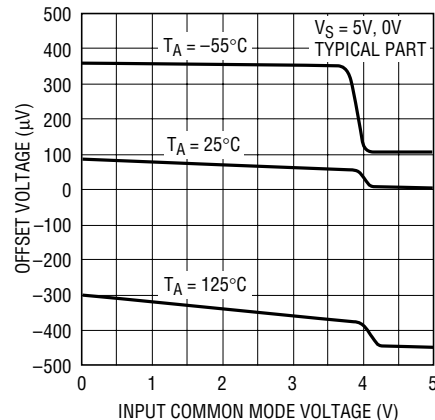

1800 G04

Input Bias Current vs Common Mode Voltage

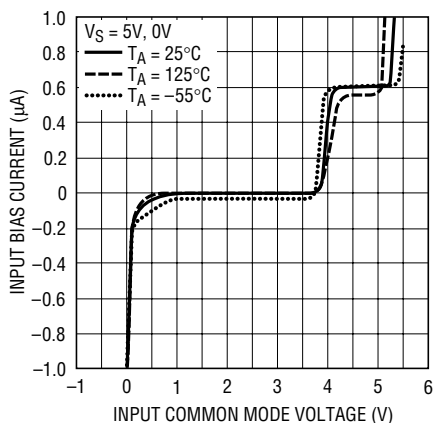

1800 G05

Input Bias Current vs Temperature

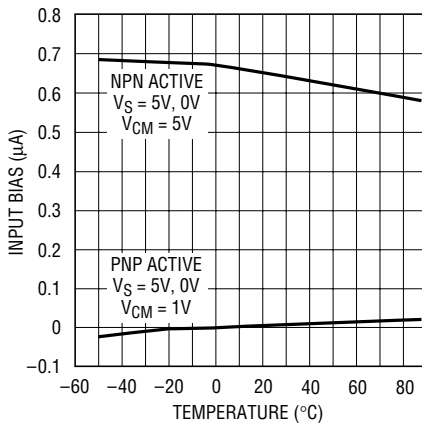

1800 G06

Output Saturation Voltage vs Load Current (Output Low)

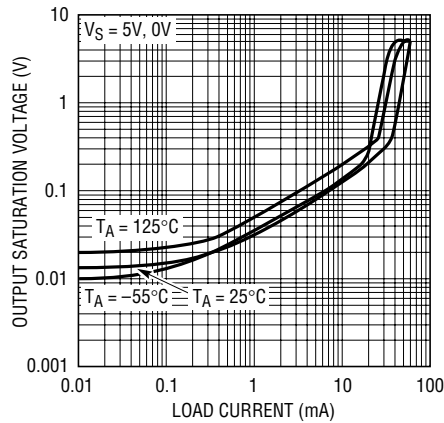

1800 G07

TYPICAL PERFORMANCE CHARACTERISTICS

Output Saturation Voltage vs Load Current (Output High)

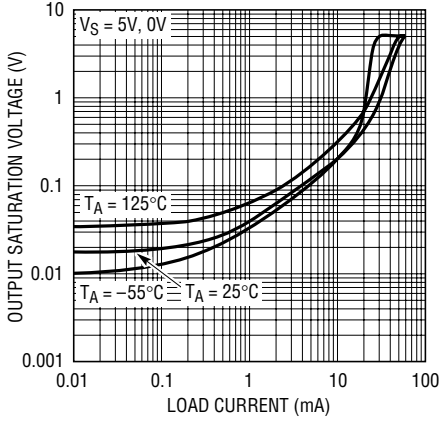

1800 G08

Minimum Supply Voltage

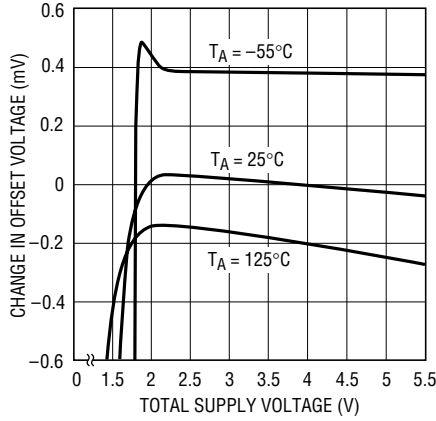

1800 G09

Output Short-Circuit Current vs Power Supply Voltage

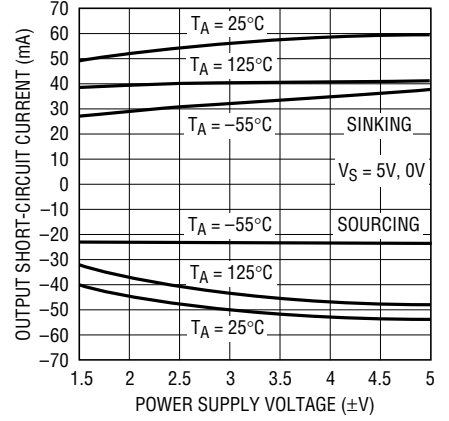

1800 G10

Open-Loop Gain

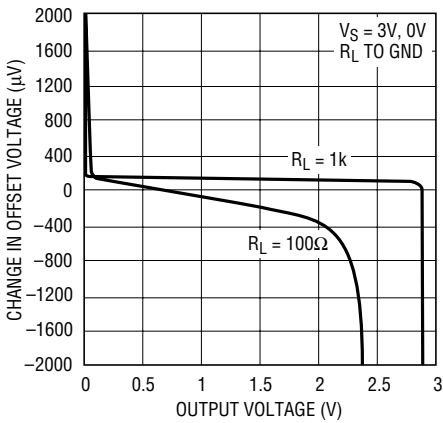

1800 G11

Open-Loop Gain

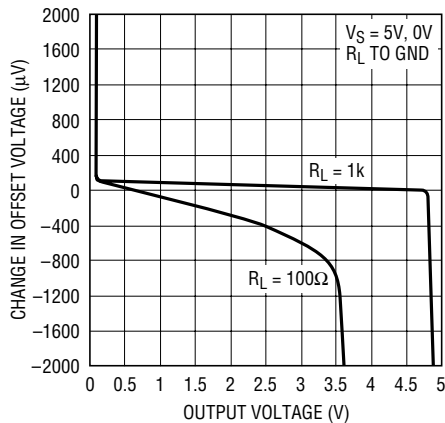

1800 G12

Open-Loop Gain

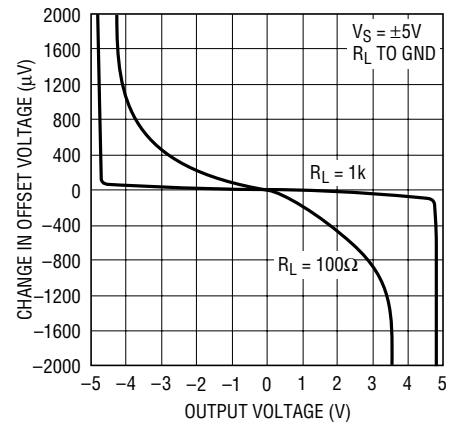

1800 G13

Offset Voltage vs Output Current

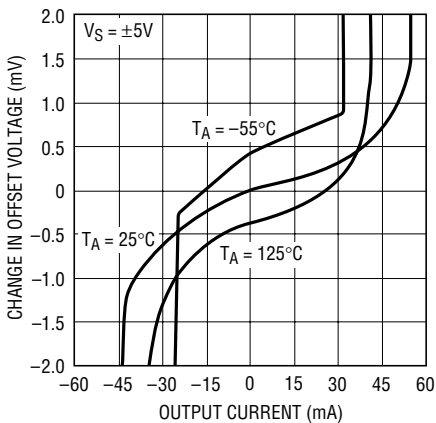

1800 G14

Warm-Up Drift vs Time (LT1800S8)

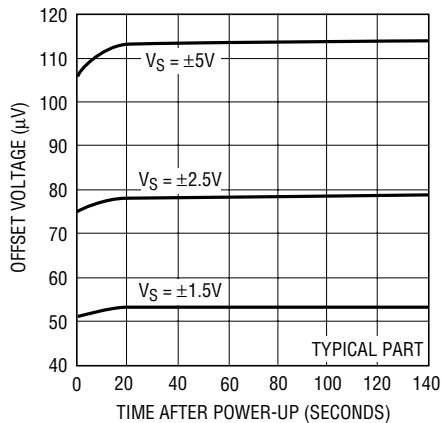

1800 G15

Input Noise Voltage vs Frequency

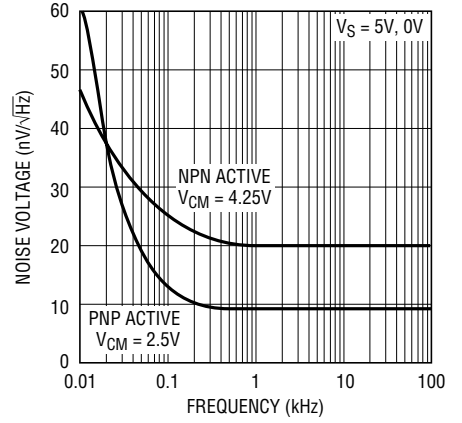

1800 G16

TYPICAL PERFORMANCE CHARACTERISTICS

Input Current Noise vs Frequency

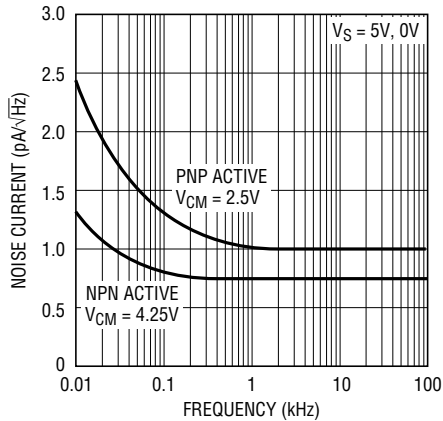

1800 G17

0.1Hz to 10Hz Output Voltage Noise

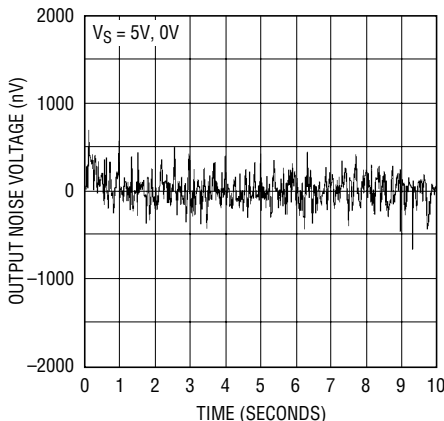

1800 G18

Gain Bandwidth and Phase Margin vs Supply Voltage

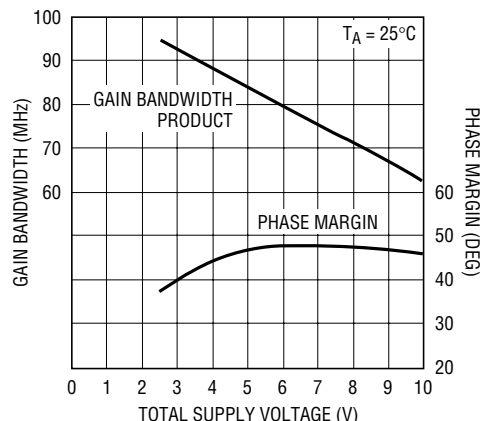

1800 G19

Gain Bandwidth and Phase Margin vs Temperature

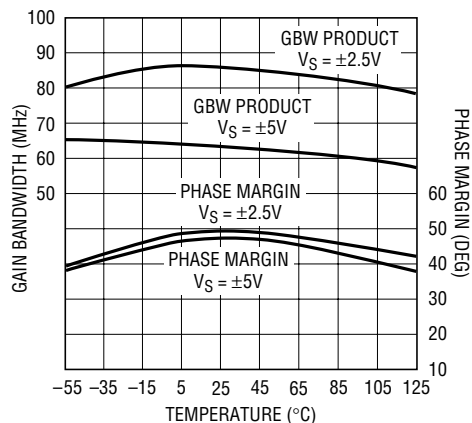

1800 G20

Slew Rate vs Temperature

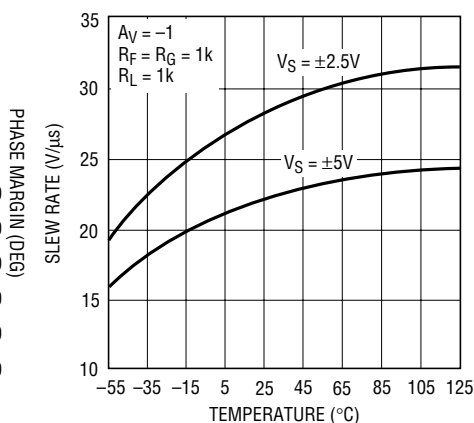

1800 G21

Gain and Phase vs Frequency

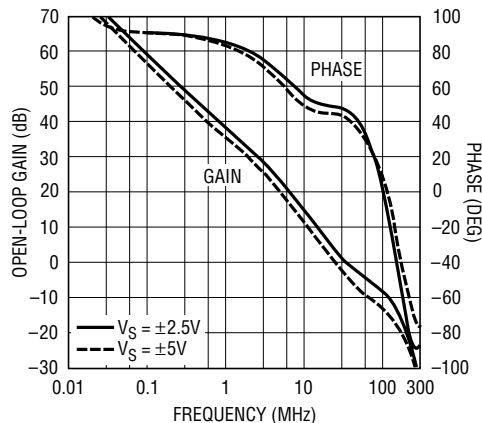

1800 G22

Gain vs Frequency ($A_V = 1$)

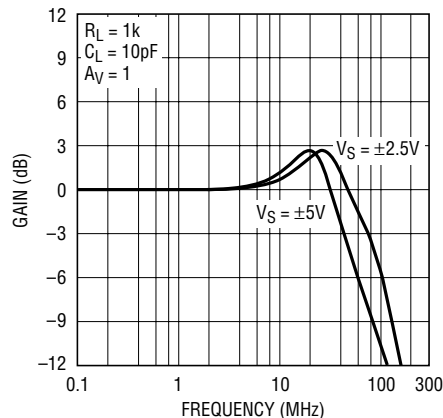

1800 G23

Gain vs Frequency ($A_V = 2$)

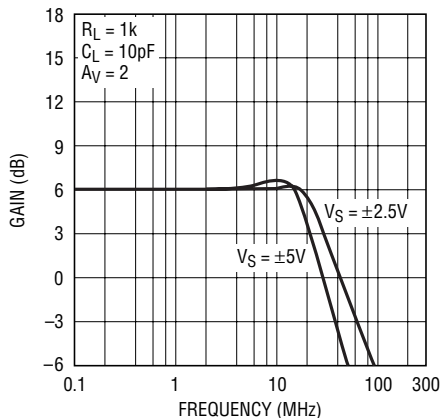

1800 G24

Output Impedance vs Frequency

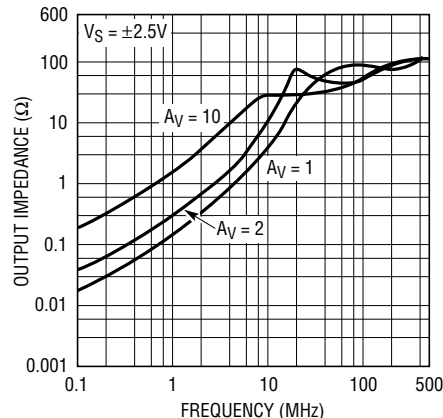

1800 G25

TYPICAL PERFORMANCE CHARACTERISTICS

Common Mode Rejection Ratio vs Frequency

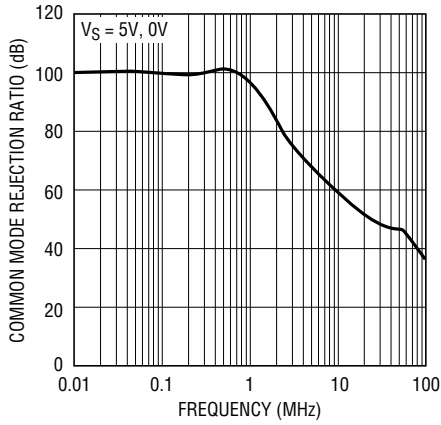

1800 G26

Power Supply Rejection Ratio vs Frequency

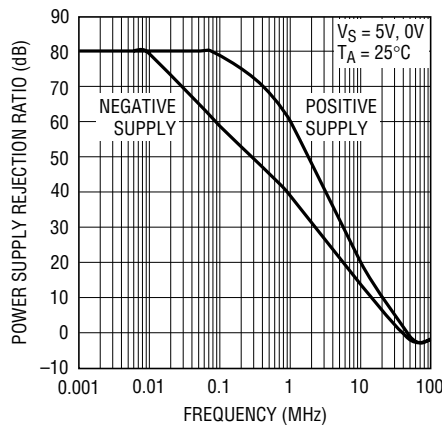

1800 G27

Series Output Resistor vs Capacitive Load

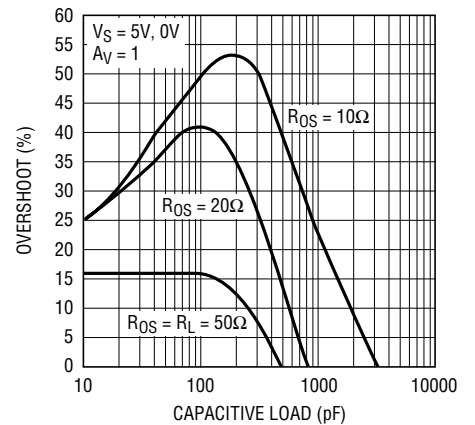

1800 G28

Series Output Resistor vs Capacitive Load

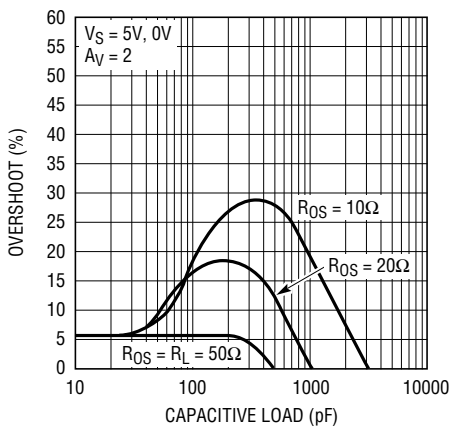

1800 G29

Distortion vs Frequency

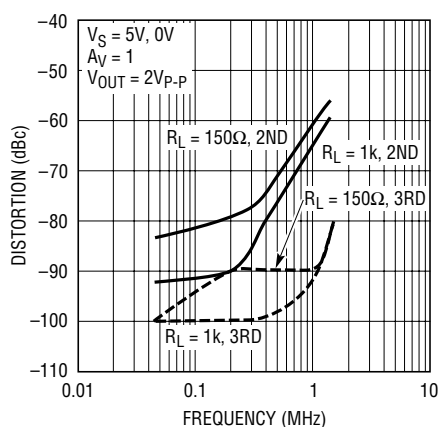

1800 G30

Distortion vs Frequency

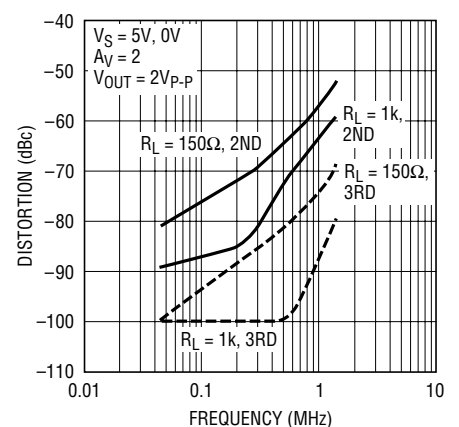

1800 G31

Maximum Undistorted Output Signal vs Frequency

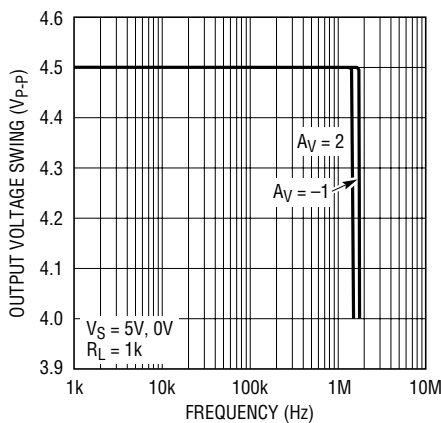

1800 G32

5V Large-Signal Response

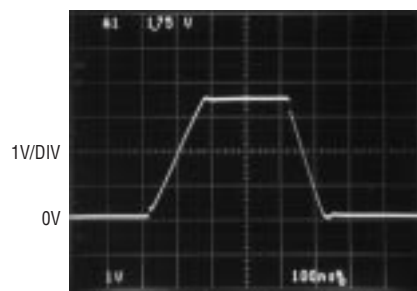

$V_S = 5V, 0V$
 $A_V = 1$
 $R_L = 1k$

1800 G33

5V Small-Signal Response

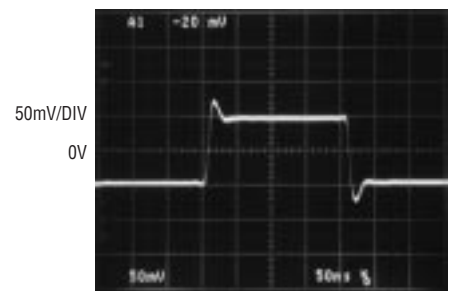

$V_S = 5V, 0V$
 $A_V = 1$
 $R_L = 1k$

1800 G34

TYPICAL PERFORMANCE CHARACTERISTICS

±5V Large-Signal Response

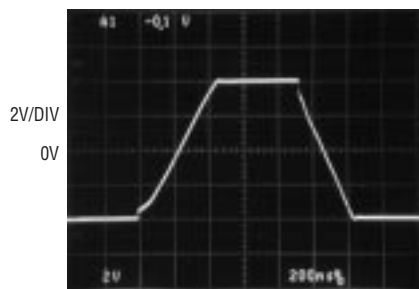

$V_S = \pm 5V$ 200ns/DIV 1800 G35
 $A_V = 1$
 $R_L = 1k$

±5V Small-Signal Response

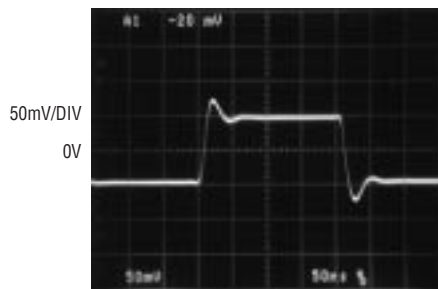

$V_S = \pm 5V$ 50ns/DIV 1800 G36
 $A_V = 1$
 $R_L = 1k$

Output Overdriven Recovery

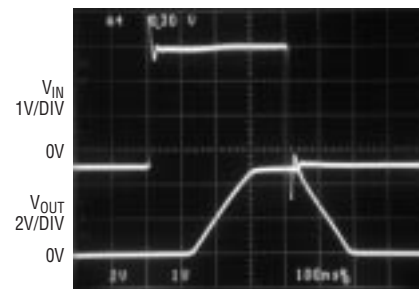

$V_S = 5V, 0V$ 100ns/DIV 1800 G37
 $A_V = 2$
 $R_L = 1k$

APPLICATIONS INFORMATION

Circuit Description

The LT1800 has an input and output signal range that covers from the negative power supply to the positive power supply. Figure 1 depicts a simplified schematic of the amplifier. The input stage is comprised of two differential amplifiers, a PNP stage Q1/Q2 and an NPN stage Q3/Q4 that are active over the different ranges of common mode input voltage. The PNP differential pair is active between the negative supply to approximately 1.2V below

the positive supply. As the input voltage moves closer toward the positive supply, the transistor Q5 will steer the tail current I_1 to the current mirror Q6/Q7, activating the NPN differential pair and the PNP pair becomes inactive for the rest of the input common mode range up to the positive supply. Also at the input stage, devices Q17 to Q19 act to cancel the bias current of the PNP input pair. When Q1-Q2 are active, the current in Q16 is controlled to be the same as the current in Q1-Q2, thus the base current

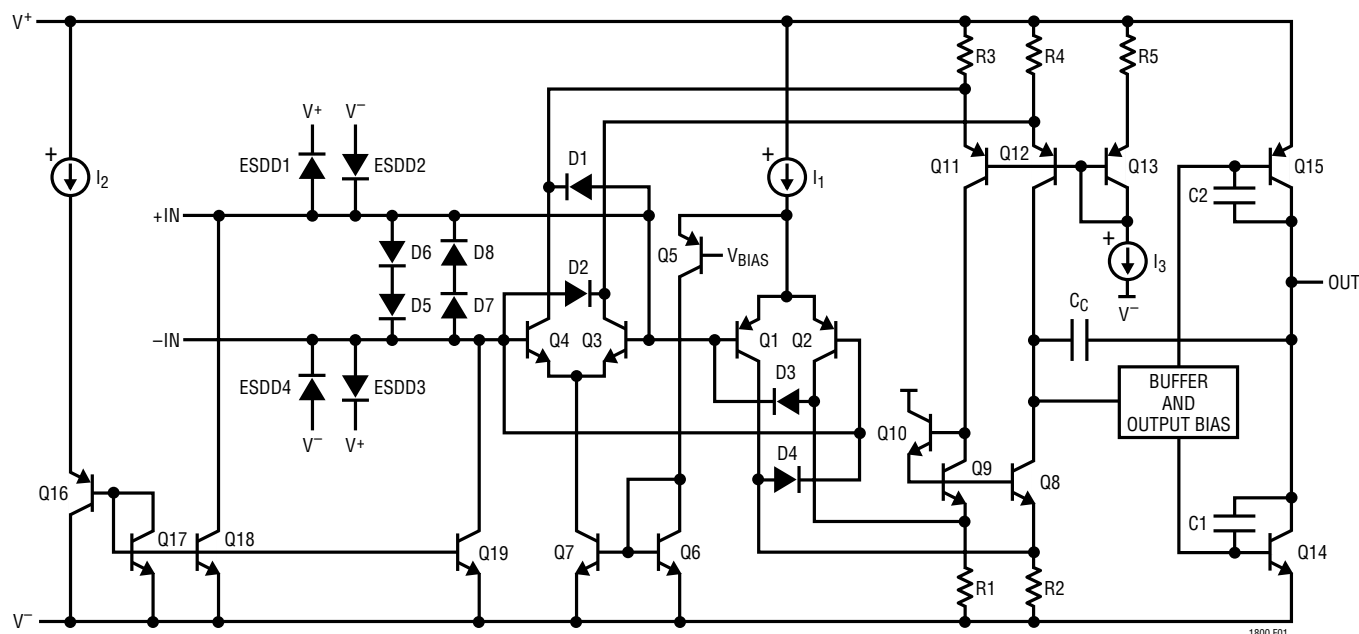

Figure 1. LT1800 Simplified Schematic Diagram

APPLICATIONS INFORMATION

of Q16 is nominally equal to the base current of the input devices. The base current of Q16 is then mirrored by devices Q17-Q19 to cancel the base current of the input devices Q1-Q2.

A pair of complementary common emitter stages Q14/Q15 that enable the output to swing from rail to rail constructs the output stage. The capacitors C2 and C3 form the local feedback loops that lower the output impedance at high frequency. These devices are fabricated on Linear Technology's proprietary high-speed complementary bipolar process.

Power Dissipation

The LT1800 amplifier is offered in a small package, SOT-23, which has a thermal resistance of $250^{\circ}\text{C}/\text{W}$, θ_{JA} . So there is a need to ensure that the die's junction temperature should not exceed 150°C . Junction temperature T_J is calculated from the ambient temperature T_A , power dissipation P_D and thermal resistance θ_{JA} :

$$T_J = T_A + (P_D \cdot \theta_{JA})$$

The power dissipation in the IC is the function of the supply voltage, output voltage and the load resistance. For a given supply voltage, the worst-case power dissipation $P_{D\text{MAX}}$ occurs at the maximum supply current and the output voltage is at half of either supply voltage (or the maximum swing is less than 1/2 supply voltage). $P_{D\text{MAX}}$ is given by:

$$P_{D\text{MAX}} = (V_S \cdot I_{S\text{MAX}}) + (V_S/2)^2/R_L$$

Example: An LT1800 in a SOT-23 package operating on $\pm 5\text{V}$ supplies and driving a 50Ω load, the worst-case power dissipation is given by:

$$P_{D\text{MAX}} = (10 \cdot 4\text{mA}) + (2.5)^2/50 = 0.04 + 0.125 = 0.165\text{W}$$

The maximum ambient temperature that the part is allowed to operate is:

$$\begin{aligned} T_A &= T_J - (P_{D\text{MAX}} \cdot 250^{\circ}\text{C}/\text{W}) \\ &= 150^{\circ}\text{C} - (0.165\text{W} \cdot 250^{\circ}\text{C}/\text{W}) = 108^{\circ}\text{C} \end{aligned}$$

Input Offset Voltage

The offset voltage will change depending upon which input stage is active. The PNP input stage is active from the negative supply rail to 1.2V of the positive supply rail, then

the NPN input stage is activated for the remaining input range up to the positive supply rail during which the PNP stage remains inactive. The offset voltage is typically less than $75\mu\text{V}$ in the range that the PNP input stage is active.

Input Bias Current

The LT1800 employs a patent-pending technique to trim the input bias current to less than 250nA for the input common mode voltage of 0.2V above negative supply rail to 1.2V of the positive rail. The low input offset voltage and low input bias current of the LT1800 provide the precision performance especially for high source impedance applications.

Output

The LT1800 can deliver a large output current, so the short-circuit current limit is set around 50mA to prevent damage to the device. Attention must be paid to keep the junction temperature of the IC below the absolute maximum rating of 150°C (refer to the Power Dissipation section) when the output is continuously short circuited. The output of the amplifier has reverse-biased diodes connected to each supply. If the output is forced beyond either supply, unlimited current will flow through these diodes. If the current is transient and limited to several hundred mA, and the total supply voltage is less than 12.6V , the absolute maximum rating, no damage will occur to the device.

Overdrive Protection

When the input voltage exceeds the power supplies, two pairs of crossing diodes D1 to D4 will prevent the output from reversing polarity. If the input voltage exceeds either power supply by 700mV , diode D1/D2 or D3/D4 will turn on to keep the output at the proper polarity. For the phase reversal protection to perform properly, the input current must be limited to less than 10mA . If the amplifier is severely overdriven, an external resistor should be used to limit the overdrive current.

The LT1800's input stages are also protected against a large differential input voltage of 1.4V or higher by a pair of back-back diodes D5/D8 to prevent the emitter-base breakdown of the input transistors. The current in these

APPLICATIONS INFORMATION

diodes should be limited to less than 10mA when they are active. The worst-case differential input voltage usually occurs when the input is driven while the output is shorted to ground in a unity gain configuration. In addition, the amplifier is protected against ESD strikes up to 3kV on all pins by a pair of protection diodes on each pin that are connected to the power supplies as shown in Figure1.

Capacitive Load

The LT1800 is optimized for high bandwidth, low power and precision applications. It can drive a capacitive load of about 75pF in a unity gain configuration, and more for higher gain. When driving a larger capacitive load, a resistor of 10Ω to 50Ω should be connected between the output and the capacitive load to avoid ringing or oscillation. The feedback should still be taken from the output so that the resistor will isolate the capacitive load to ensure

stability. Graphs on capacitive loads indicate the transient response of the amplifier when driving capacitive load with a specified series resistor.

Feedback Components

When feedback resistors are used to set up gain, care must be taken to ensure that the pole formed by the feedback resistors and the total capacitance at the inverting input does not degrade stability. For instance, the LT1800 in a noninverting gain of 2, set up with two 5k resistors and a capacitance of 5pF (part plus PC board) will probably ring in transient response. The pole is formed at 12.7MHz that will reduce phase margin by 32 degrees when the cross-over frequency of the amplifier is around 20MHz. A capacitor of 5pF or higher connected across the feedback resistor will eliminate any ringing or oscillation.

APPLICATIONS INFORMATION

Single Supply 1A Laser Driver Amplifier

The circuit in the front page of this data sheet shows the LT1800 used in a 1A laser driver application. One of the reasons the LT1800 is well suited to this control task is that its 2.3V operation ensures that it will be awake during power-up and operated before the circuit can otherwise cause significant current to flow in the 2.1V threshold laser diode. Driving the noninverting input of the LT1800 to a voltage V_{IN} will control the turning on of the high current NPN transistor, FMMT619 and the laser diode. A current equal to $V_{IN}/R1$ flows through the laser diode. The LT1800 low offset voltage and low input bias current allows it to control the current that flows through the laser diode precisely. The overall circuit is a 1A per Volt V-to-I converter. Frequency compensation components R2 and C1 are selected for fast but zero-overshoot time domain response to avoid overcurrent conditions in the laser. The time domain response of this circuit, measured at R1 and given a 500mV 230ns input pulse, is also shown in the graphic on the front page. While the circuit is capable of 1A operation, the laser diode and the transistor are thermally limited due to power dissipation, so they must be operated at low duty cycles.

Fast 1A Current Sense Amplifier

A simple, fast current sense amplifier in Figure 2 is suitable for quickly responding to out-of-range currents. The circuit amplifies the voltage across the 0.1Ω sense resistor by a gain of 20, resulting in a conversion gain of 2V/A. The -3dB bandwidth of the circuit is 4MHz, and the uncertainty due to V_{OS} and I_B is less than 4mA. The minimum output voltage is 60mV, corresponding to 30mA. The large-signal response of the circuit is shown in Figure 3.

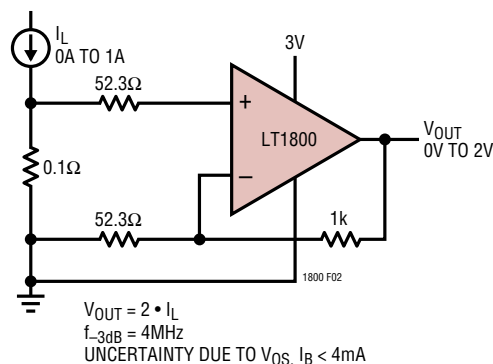

Figure 2. Fast 1A Current Sense

TYPICAL APPLICATIONS

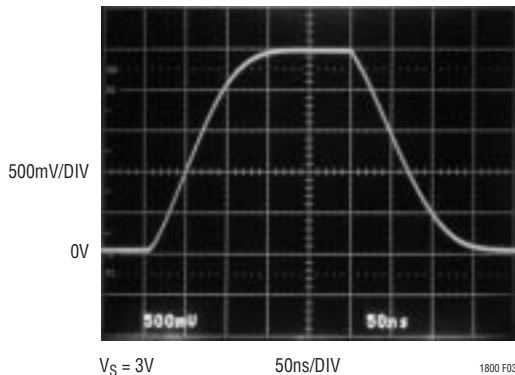

Figure 3. Current Sense Amplifier Large-Signal Response

Single 3V Supply, 1MHz, 4th Order Butterworth Filter

The circuit shown in Figure 4 makes use of the low voltage operation and the wide bandwidth of the LT1800 to create a DC accurate 1MHz 4th order lowpass filter powered from a 3V supply. The amplifiers are configured in the inverting mode for the lowest distortion and the output can swing rail-to-rail for maximum dynamic range. Figure 5 displays the frequency response of the filter. Stopband attenuation is greater than 100dB at 50MHz. With a 2.25V_{P-P}, 250kHz input signal, the filter has harmonic distortion products of less than -85dBc. Worst case output offset voltage is less than 6mV.

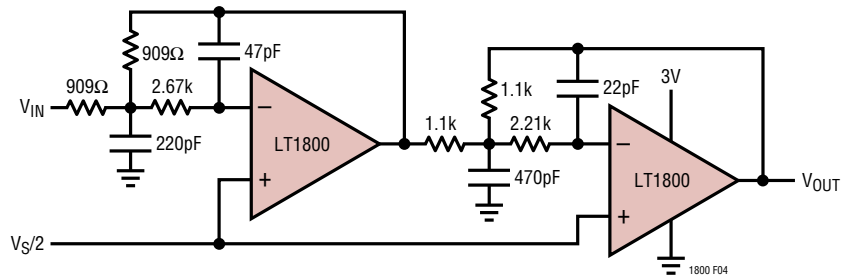

Figure 4. 3V, 1MHz, 4th Order Butterworth Filter

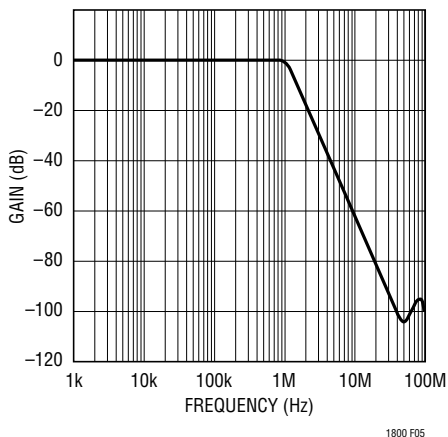
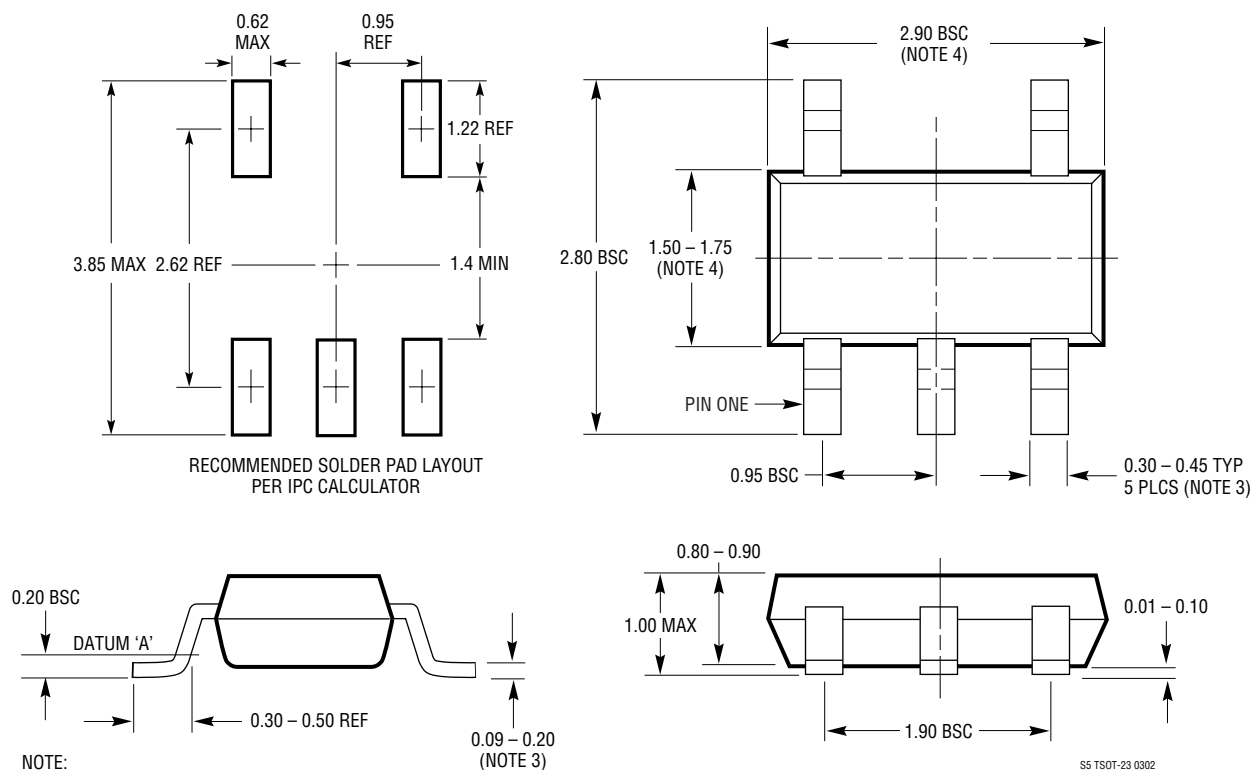

Figure 5. Frequency Response of Filter

PACKAGE DESCRIPTION

S6 Package 6-Lead Plastic TSOT-23 (Reference LTC DWG # 05-08-1636)



- NOTE:
1. DIMENSIONS ARE IN MILLIMETERS
 2. DRAWING NOT TO SCALE
 3. DIMENSIONS ARE INCLUSIVE OF PLATING
 4. DIMENSIONS ARE EXCLUSIVE OF MOLD FLASH AND METAL BURR
 5. MOLD FLASH SHALL NOT EXCEED 0.254mm
 6. JEDEC PACKAGE REFERENCE IS MO-193

S8 Package 8-Lead Plastic Small Outline (Narrow .150 Inch) (Reference LTC DWG # 05-08-1610)

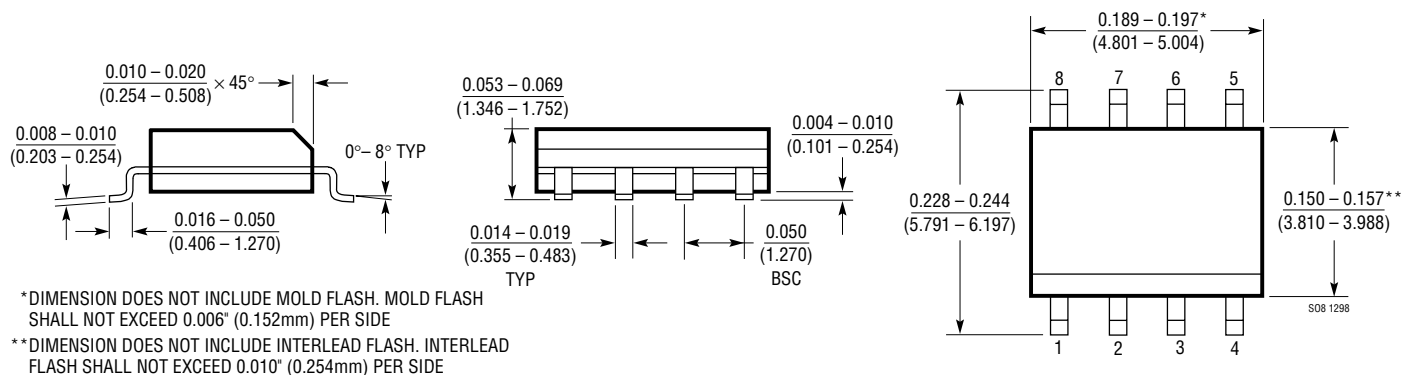

TYPICAL APPLICATION

Low Power High Voltage Amplifier

Certain materials used in optical applications have characteristics that change due to the presence and strength of a DC electric field. The voltage applied across these materials should be precisely controlled to maintain desired properties, sometimes as high as 100's of volts. The materials are not conductive and represent a capacitive load.

The circuit of Figure 6 shows the LT1800 used in an amplifier capable of a 250V output swing and providing

precise DC output voltage. When no signal is present, the op amp output sits at about mid-supply. Transistors Q1 and Q3 create bias voltages for Q2 and Q4, which are forced into a low quiescent current by degeneration resistors R4 and R5. When a transient signal arrives at V_{IN} , the op amp output moves and causes the current in Q2 or Q4 to change depending on the signal polarity. The current, limited by the clipping of the LT1800 output and the 3kΩ of total emitter degeneration, is mirrored to the output devices to drive the capacitive load. The LT1800 output then returns to near mid-supply, providing the precise DC output voltage to the load. The attention to limit the current of the output devices minimizes power dissipation thus allowing for dense layout, and inherits better reliability. Figure 7 shows the time domain response of the amplifier providing a 200V output swing into a 100pF load.

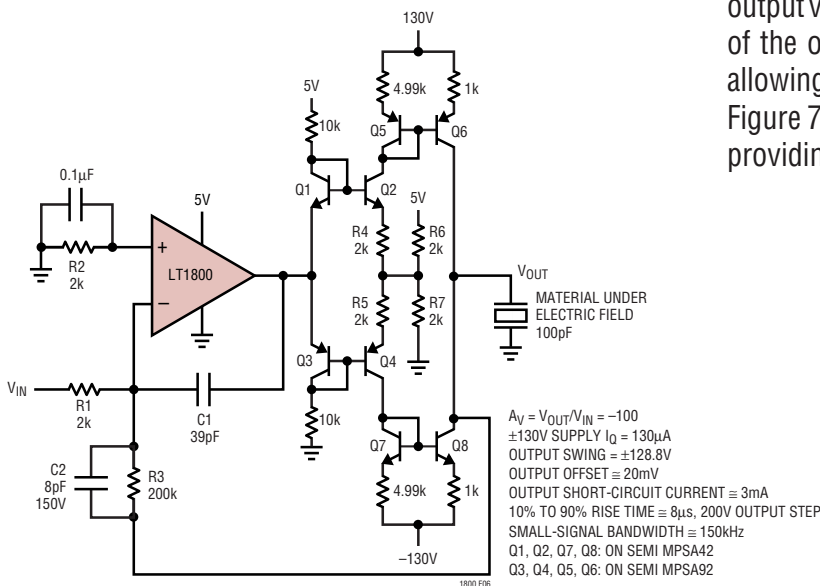

Figure 6. Low Power, High Voltage Amplifier

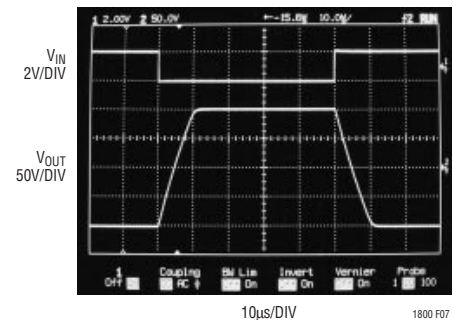

Figure 7. Large-Signal Time Domain Response of the Amplifier

RELATED PARTS

| PART NUMBER | DESCRIPTION | COMMENTS |
|---------------|---|--|
| LT1399 | Triple 300MHz Current Feedback Amplifier | 0.1dB Gain Flatness to 150MHz, Shutdown |
| LT1498/LT1499 | Dual/Quad 10MHz, 6V μs Rail-to-Rail Input and Output C-Load™ Op Amps | High DC Accuracy, 475 μV $V_{OS(MAX)}$, 4 $\mu V/^\circ C$ Max Drift, Max Supply Current 2.2mA per Amp |
| LT1630/LT1631 | Dual/Quad 30MHz, 10V/ μs Rail-to-Rail Input and Output Op Amps | High DC Accuracy, 525 μV $V_{OS(MAX)}$, 70mA Output Current, Max Supply Current 4.4mA per Amplifier |
| LT1801/LT1802 | 80MHz, 25V/ μs Low Power Rail-to-Rail Input/Output Precision Op Amps | Dual/Quad Version of the LT1800 |
| LT1806/LT1807 | Single/Dual 325MHz, 140V/ μs Rail-to-Rail Input and Output Op Amps | High DC Accuracy, 550 μV $V_{OS(MAX)}$, Low Noise 3.5nV/ \sqrt{Hz} , Low Distortion -80dB at 5MHz, Power-Down (LT1806) |
| LT1809/LT1810 | Single/Dual 180MHz Rail-to-Rail Input/Output Op Amps | 350V/ μs Slew Rate, Low Distortion -90dBc at 5MHz, Power-Down (LT1809) |

C-Load is a trademark of Linear Technology Corporation.