

LT1□67A series

1608 Size, 0.8mm Thickness, Leadless Chip LED Devices

Outline Dimensions

(Unit : mm)

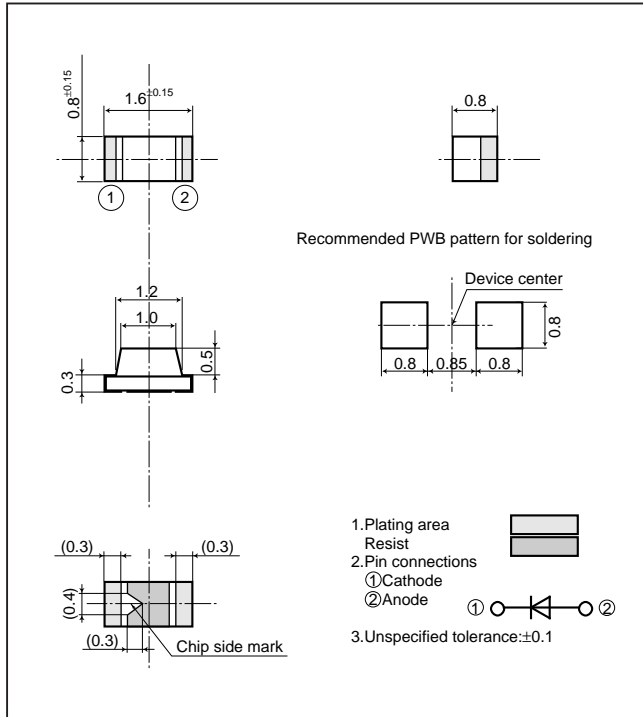

U type: There is Anode mark on the device because polarity faces in the opposite direction.

Radiation Diagram

(Ta=25°C)

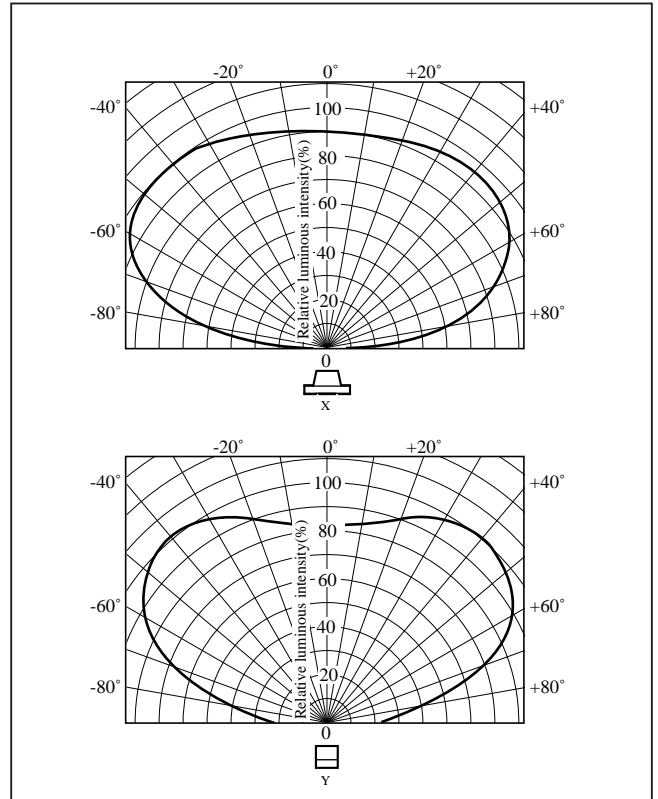

Absolute Maximum Ratings

(Ta=25°C)

Model No.	Radiation color	Radiation material	Power dissipation P (mW)	Forward current IF (mA)	Peak forward current IFM*1 (mA)	Derating factor (mA/°C)		Reverse voltage VR (V)	Operating temperature Topr (°C)	Storage temperature Tstg (°C)	Soldering temperature Tsol*2 (°C)
						DC	Pulse				
LT1U67A	Red(Super-luminosity)	GaAlAs on GaAlAs	75	30	50	0.40	0.67	4	-30 to +85	-40 to +100	350
LT1P67A	Red	GaP	23	10	50	0.13	0.67	5	-30 to +85	-40 to +100	350
LT1D67A	Red	GaAsP on GaP	84	30	50	0.40	0.67	5	-30 to +85	-40 to +100	350
LT1S67A	Sunset orange	GaAsP on GaP	84	30	50	0.40	0.67	5	-30 to +85	-40 to +100	350
LT1H67A	Yellow	GaAsP on GaP	84	30	50	0.40	0.67	5	-30 to +85	-40 to +100	350
LT1E67A	Yellow-green	GaP	84	30	50	0.40	0.67	5	-30 to +85	-40 to +100	350
LT1F67A	Yellow-green(High-luminosity)	GaP	84	30	50	0.40	0.67	5	-30 to +85	-40 to +100	350
LT1K67A	Green	GaP	84	30	50	0.40	0.67	5	-30 to +85	-40 to +100	350

*1 Duty ratio=1/10, Pulse width=0.1ms

*2 For 3s or less at the temperature of hand soldering. Temperature of reflow soldering is shown on the below page.

Electro-optical Characteristics

(Ta=25°C)

Lens type	Model No.	Forward voltage VF(V)		Peak emission wavelength		Luminous intensity		Spectrum radiation bandwidth		Reverse current		Terminal capacitance		Page for characteristics diagrams
		TYP	MAX	λp(nm) TYP	IF (mA)	Iv(mcd) TYP	IF (mA)	Δλ(nm) TYP	IF (mA)	IR(μA) MAX	VR (V)	Ci(pF) TYP	(MHz)	
Milky diffusion	LT1U67A	1.85	2.5	660	20	29.7	20	20	20	100	3	25	1	→
	LT1P67A	1.9	2.3	695	5	1.3	5	100	5	10	4	55	1	→
	LT1D67A	2.0	2.8	635	20	8.8	20	35	20	10	4	20	1	→
	LT1S67A	2.0	2.8	610	20	6.9	20	35	20	10	4	15	1	→
	LT1H67A	2.0	2.8	585	20	8.3	20	30	20	10	4	35	1	→
	LT1E67A	2.1	2.8	565	20	11.0	20	30	20	10	4	35	1	→
	LT1F67A	2.1	2.8	570	20	19.0	20	30	20	10	4	35	1	→
LT1K67A	2.1	2.8	555	20	3.8	20	25	20	10	4	40	1	→	

(Notice) • In the absence of confirmation by device specification sheets, SHARP takes no responsibility for any defects that may occur in equipment using any SHARP devices shown in catalogs, data books, etc. Contact SHARP in order to obtain the latest device specification sheets before using any SHARP device.
 (Internet) • Data for sharp's optoelectronic/power device is provided for internet.(Address <http://www.sharp.co.jp/ecg/>)

LED Lamp Characteristics Diagrams

PR series



HD series



Note) Characteristics shown in diagrams are typical values. (not assurance value)

- (Notice) • In the absence of confirmation by device specification sheets, SHARP takes no responsibility for any defects that may occur in equipment using any SHARP devices shown in catalogs, data books, etc. Contact SHARP in order to obtain the latest device specification sheets before using any SHARP device.
 (Internet) • Data for sharp's optoelectronic/power device is provided for internet.(Address <http://www.sharp.co.jp/ecg/>)

LED Lamp Characteristics Diagrams

HS series

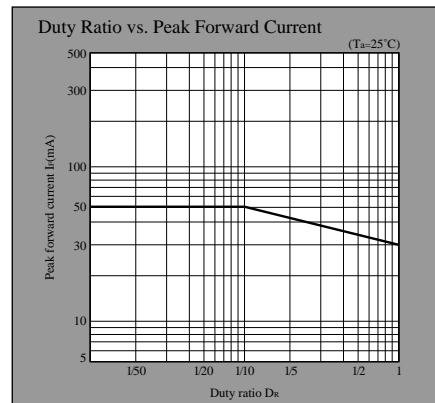
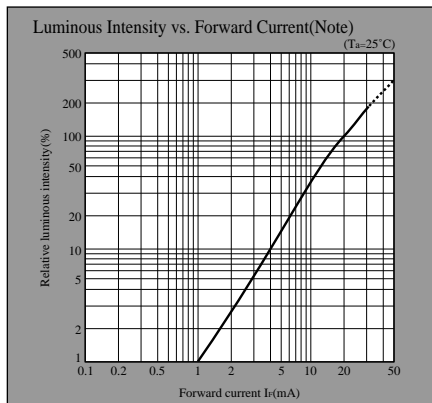
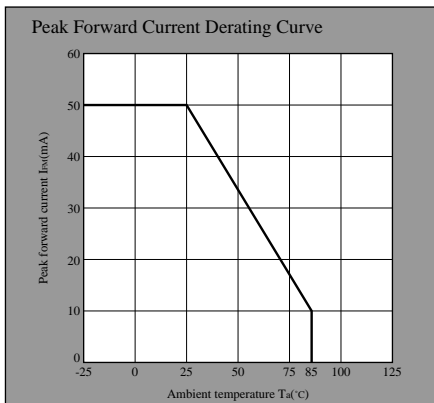
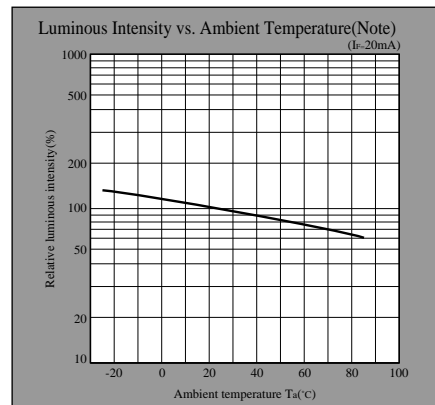
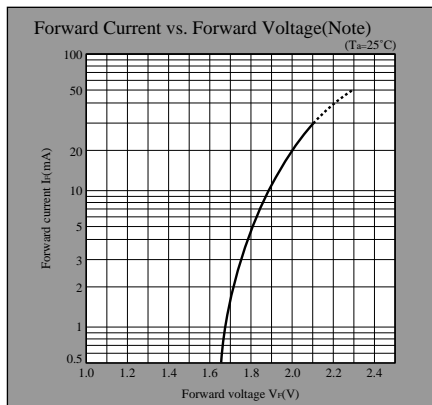
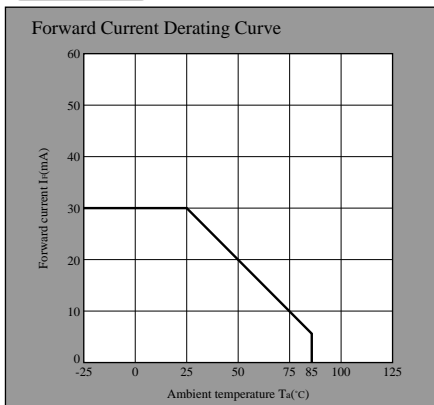

HY series

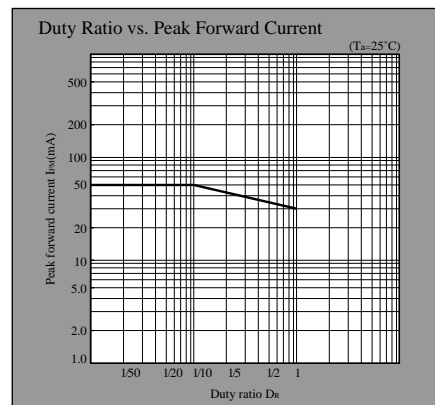
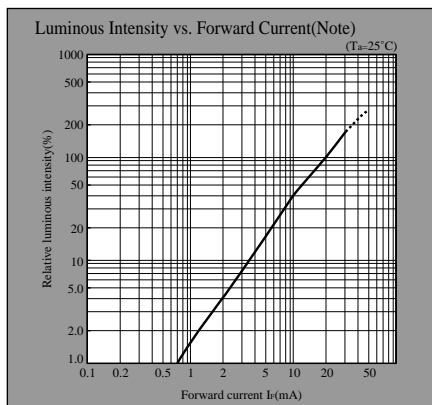
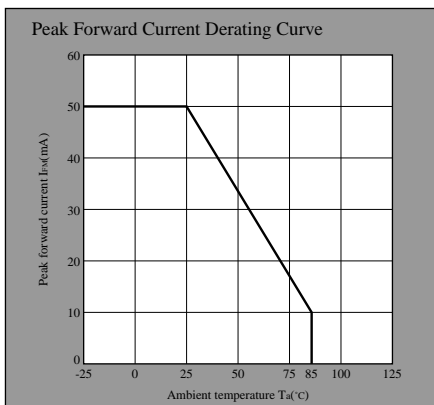
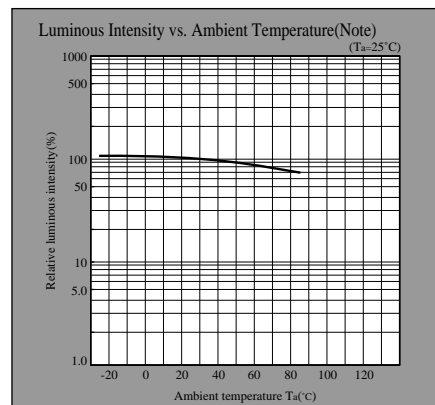
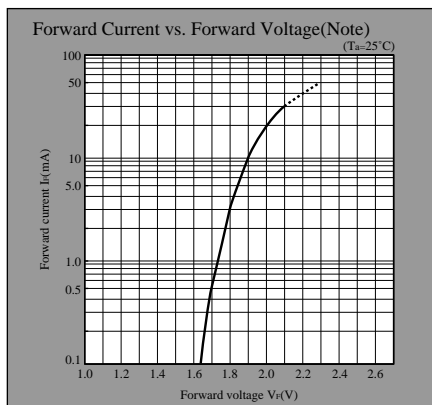
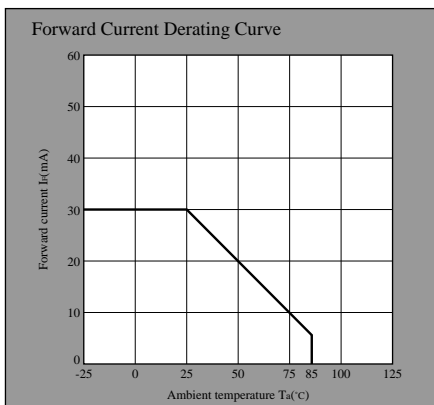

Note) Characteristics shown in diagrams are typical values. (not assurance value)

- (Notice) • In the absence of confirmation by device specification sheets, SHARP takes no responsibility for any defects that may occur in equipment using any SHARP devices shown in catalogs, data books, etc. Contact SHARP in order to obtain the latest device specification sheets before using any SHARP device.
 (Internet) • Data for sharp's optoelectronic/power device is provided for internet. (Address <http://www.sharp.co.jp/ecg/>)

LED Lamp Characteristics Diagrams

EG series

Forward Current Derating Curve

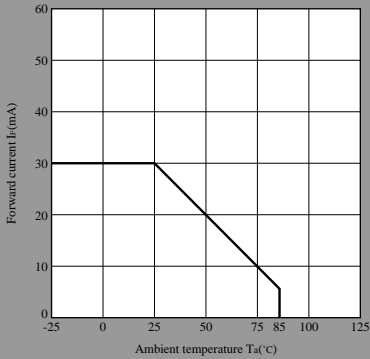

Forward Current vs. Forward Voltage(Note)

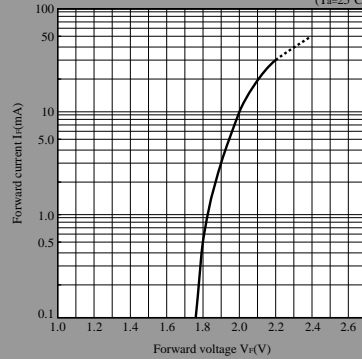

Luminous Intensity vs. Ambient Temperature(Note)

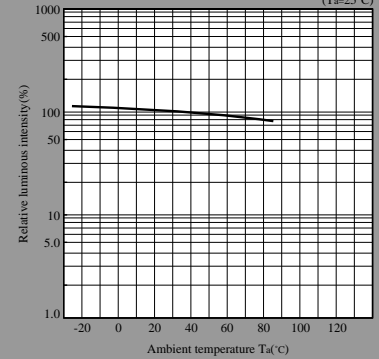

Peak Forward Current Derating Curve



Luminous Intensity vs. Forward Current(Note)



Duty Ratio vs. Peak Forward Current

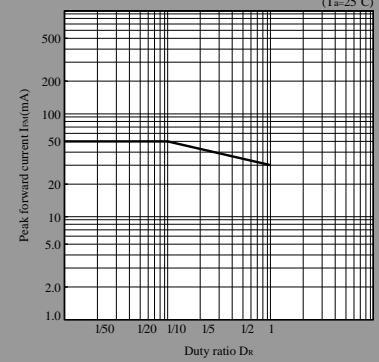

KG series

Forward Current Derating Curve



Forward Current vs. Forward Voltage(Note)



Luminous Intensity vs. Ambient Temperature(Note)

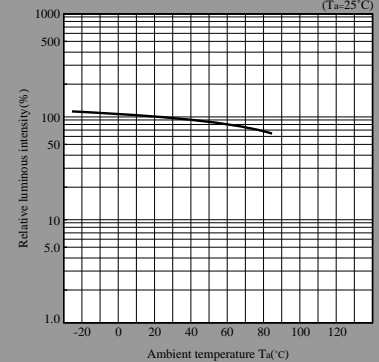

Peak Forward Current Derating Curve



Luminous Intensity vs. Forward Current(Note)



Duty Ratio vs. Peak Forward Current

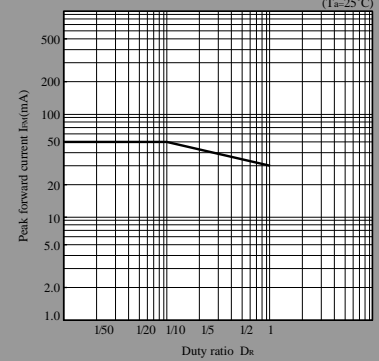

Note) Characteristics shown in diagrams are typical values. (not assurance value)

- (Notice) • In the absence of confirmation by device specification sheets, SHARP takes no responsibility for any defects that may occur in equipment using any SHARP devices shown in catalogs, data books, etc. Contact SHARP in order to obtain the latest device specification sheets before using any SHARP device.
 (Internet) • Data for sharp's optoelectronic/power device is provided for internet.(Address <http://www.sharp.co.jp/ecg/>)

UR series

Forward Current Derating Curve

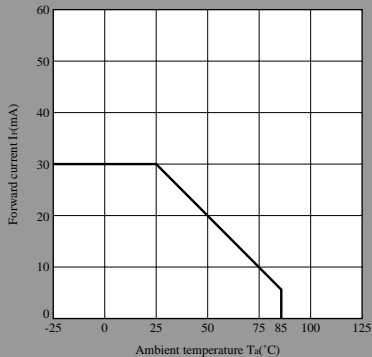

Forward Current vs. Forward Voltage(Note)

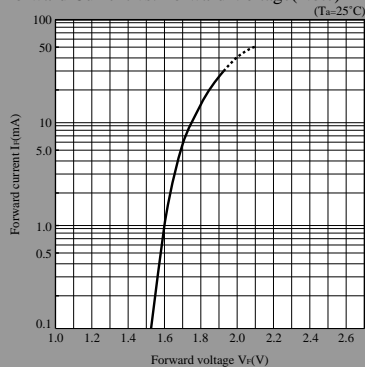

Luminous Intensity vs. Ambient Temperature(Note)

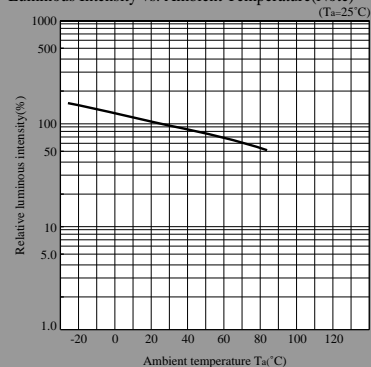

Peak Forward Current Derating Curve

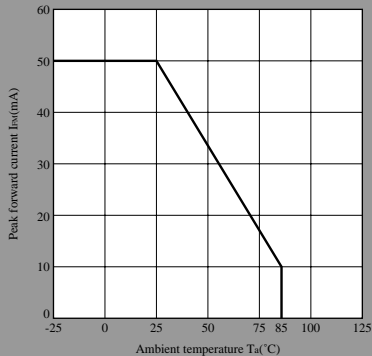

Luminous Intensity vs. Forward Current(Note)

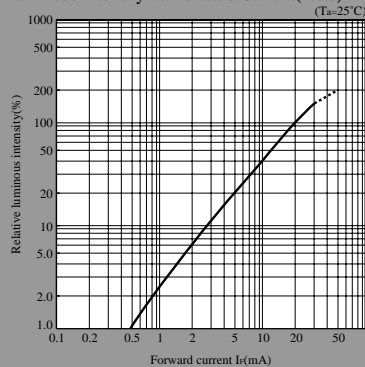

Duty Ratio vs. Peak Forward Current

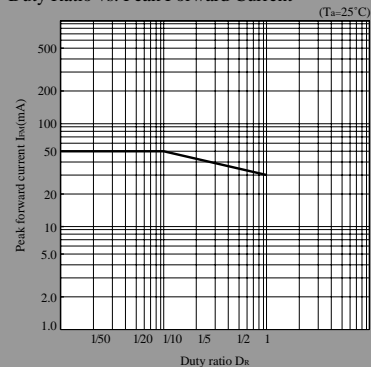

Note) Characteristics shown in diagrams are typical values. (not assurance value)