

LT1□73A series

2.75×1.45mm, 0.9mm Thickness, Compact Milky Diffusion Chip LED Devices

Outline Dimensions

(Unit : mm)

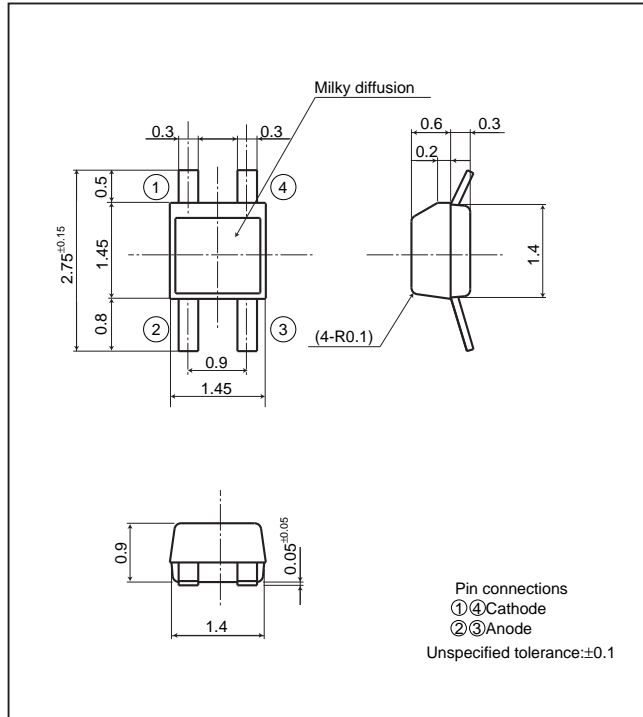

T type: Polarity faces in the opposite direction.

Radiation Diagram

(Ta=25°C)

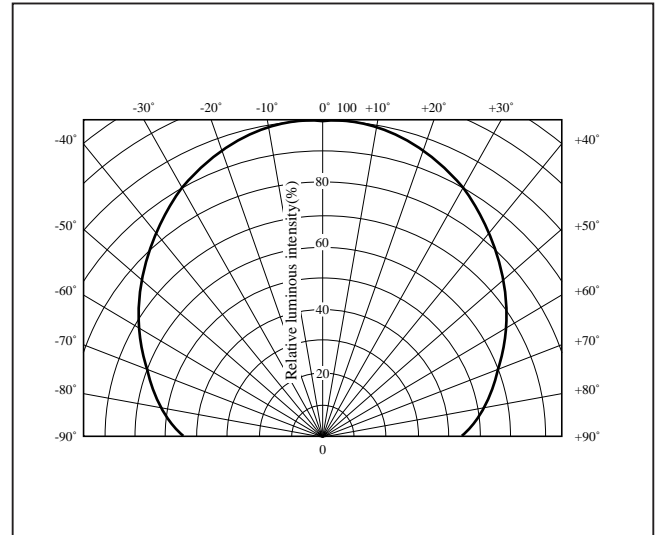

Absolute Maximum Ratings

(Ta=25°C)

Model No.	Radiation color	Radiation material	Power dissipation P (mW)	Forward current IF (mA)	Peak forward current IFM ^{*1} (mA)	Derating factor (mA/°C)		Reverse voltage VR (V)	Operating temperature T _{opr} (°C)	Storage temperature T _{stg} (°C)	Soldering temperature T _{sol} ^{*2} (°C)
						DC	Pulse				
LT1T73A	Red(High-luminosity)	GaAlAs on GaAs	66	30	50	0.40	0.67	5	-25 to +85	-25 to +100	350
LT1P73A	Red	GaP	23	10	50	0.13	0.67	5	-25 to +85	-25 to +100	350
LT1D73A	Red	GaAsP on GaP	85	30	50	0.40	0.67	5	-25 to +85	-25 to +100	350
LT1S73A	Sunset orange	GaAsP on GaP	85	30	50	0.40	0.67	5	-25 to +85	-25 to +100	350
LT1H73A	Yellow	GaAsP on GaP	50	20	50	0.27	0.67	5	-25 to +85	-25 to +100	350
LT1E73A	Yellow-green	GaP	50	20	50	0.27	0.67	5	-25 to +85	-25 to +100	350
LT1K73A	Green	GaP	50	20	50	0.27	0.67	5	-25 to +85	-25 to +100	350

*1 Duty ratio=1/10, Pulse width=0.1ms

*2 For 3s or less at the temperature of hand soldering. Temperature of reflow soldering is shown on the below page.

Electro-optical Characteristics

(Ta=25°C)

Lens type	Model No.	Forward voltage VF(V)		Peak emission wavelength		Luminous intensity		Spectrum radiation bandwidth		Reverse current		Terminal capacitance		Page for characteristics diagrams
		TYP	MAX	λ _p (nm)	IF (mA)	Iv(mcd)	IF (mA)	Δλ(nm)	IF (mA)	IR(μA)	VR (V)	Ct(pF)	(MHz)	
Milky diffusion	LT1T73A	1.75	2.2	660	20	7.0	20	20	20	10	4	30	1	→
	LT1P73A	1.9	2.3	695	5	1.2	5	100	5	10	4	55	1	→
	LT1D73A	2.0	2.8	635	20	9.0	20	35	20	10	4	20	1	→
	LT1S73A	2.0	2.8	610	20	7.8	20	35	20	10	4	15	1	→
	LT1H73A	1.9	2.5	585	10	3.7	10	30	10	10	4	35	1	→
	LT1E73A	1.95	2.5	565	10	4.7	10	30	10	10	4	35	1	→
	LT1K73A	1.95	2.5	555	10	1.9	10	25	10	10	4	40	1	→

(Notice) • In the absence of confirmation by device specification sheets, SHARP takes no responsibility for any defects that may occur in equipment using any SHARP devices shown in catalogs, data books, etc. Contact SHARP in order to obtain the latest device specification sheets before using any SHARP device.

(Internet) • Data for sharp's optoelectronic/power device is provided for internet.(Address <http://www.sharp.co.jp/ecg/>)

LED Lamp Characteristics Diagrams

PR series



HD series



Note) Characteristics shown in diagrams are typical values. (not assurance value)

- (Notice) • In the absence of confirmation by device specification sheets, SHARP takes no responsibility for any defects that may occur in equipment using any SHARP devices shown in catalogs, data books, etc. Contact SHARP in order to obtain the latest device specification sheets before using any SHARP device.
 (Internet) • Data for sharp's optoelectronic/power device is provided for internet.(Address <http://www.sharp.co.jp/ecg/>)

LED Lamp Characteristics Diagrams

HS series

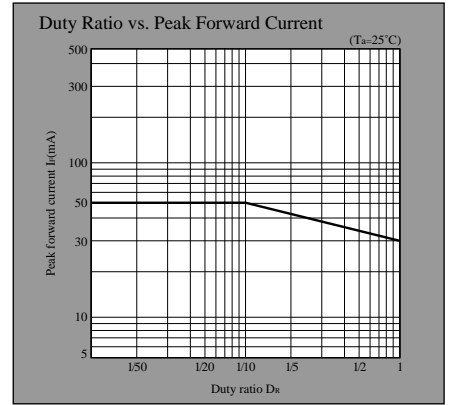
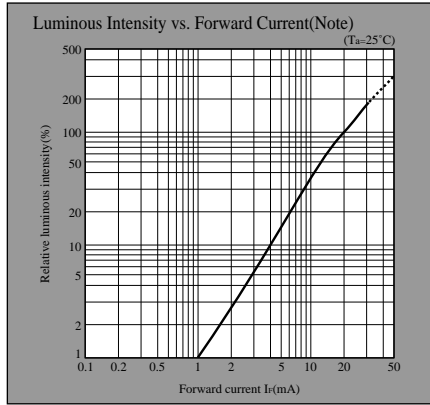
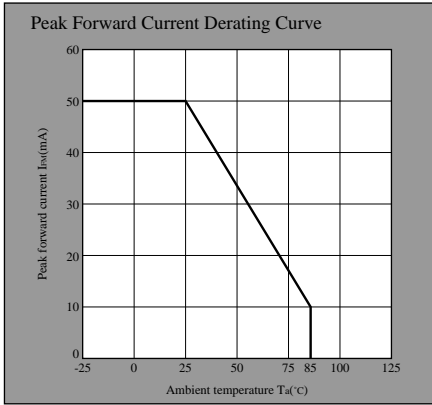
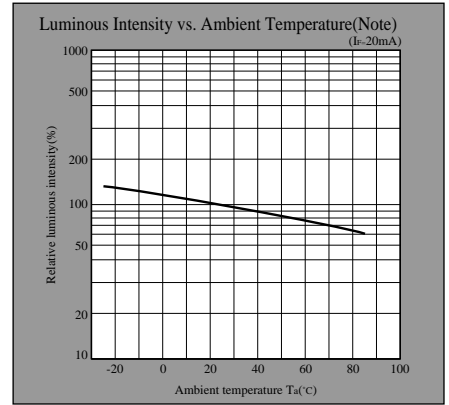
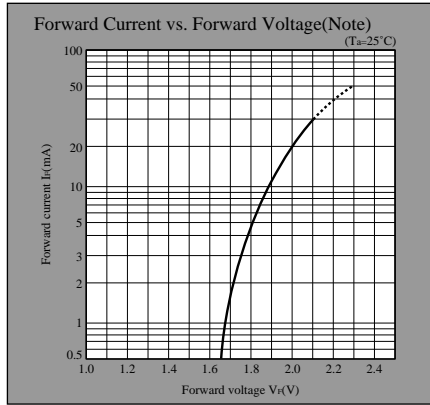
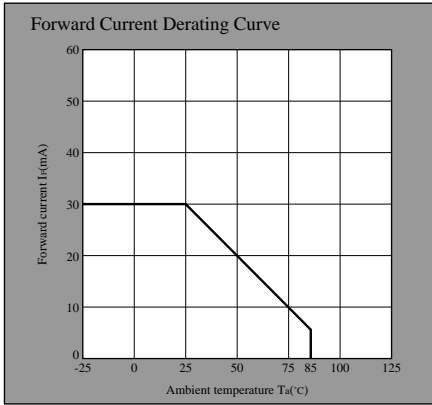

HY series

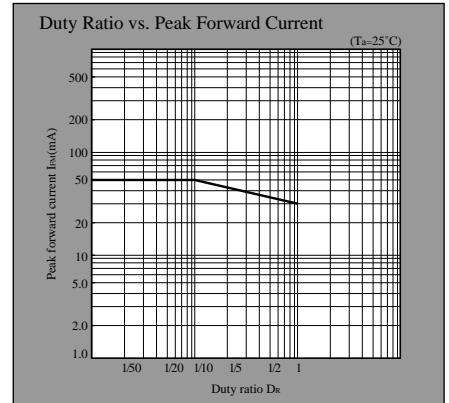
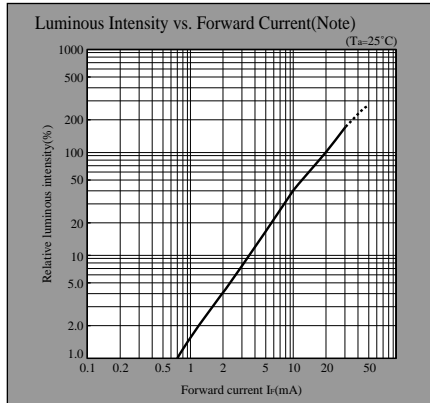
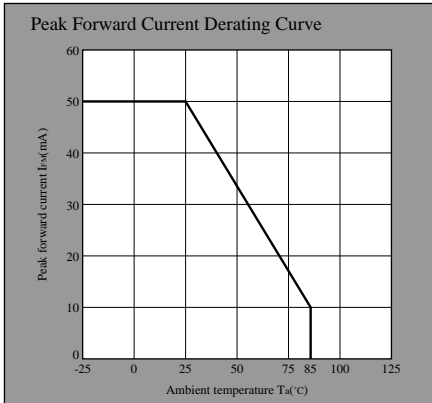
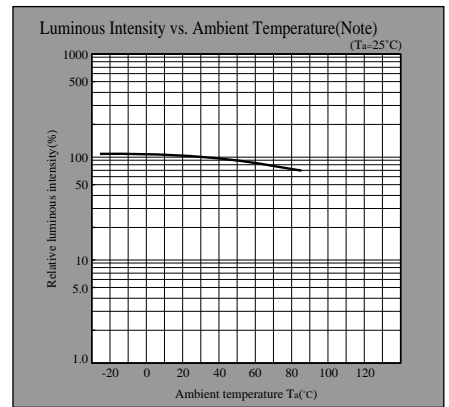
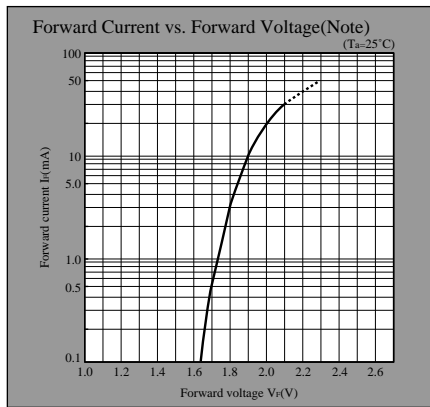
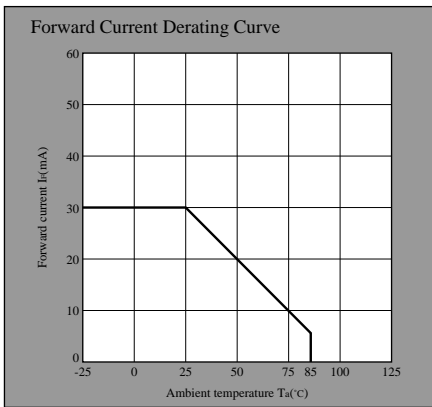

Note) Characteristics shown in diagrams are typical values. (not assurance value)

- (Notice) • In the absence of confirmation by device specification sheets, SHARP takes no responsibility for any defects that may occur in equipment using any SHARP devices shown in catalogs, data books, etc. Contact SHARP in order to obtain the latest device specification sheets before using any SHARP device.
 (Internet) • Data for sharp's optoelectronic/power device is provided for internet. (Address <http://www.sharp.co.jp/ecg/>)

LED Lamp Characteristics Diagrams

EG series

Forward Current Derating Curve

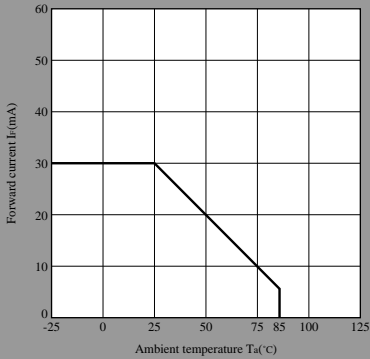

Forward Current vs. Forward Voltage(Note)

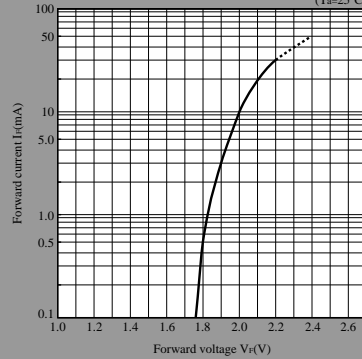

Luminous Intensity vs. Ambient Temperature(Note)

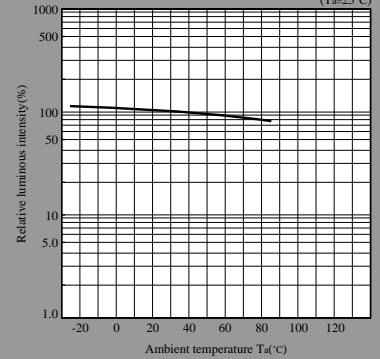

Peak Forward Current Derating Curve

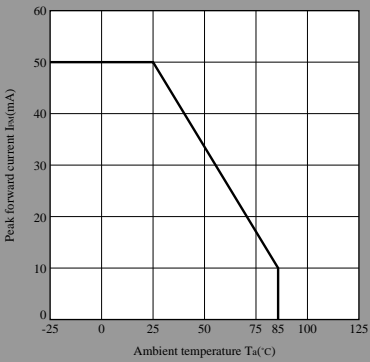

Luminous Intensity vs. Forward Current(Note)

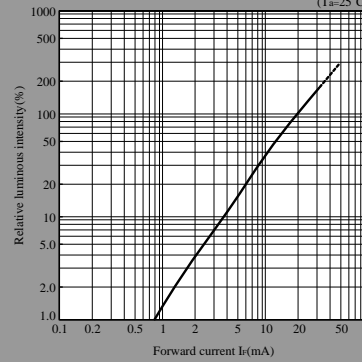

Duty Ratio vs. Peak Forward Current

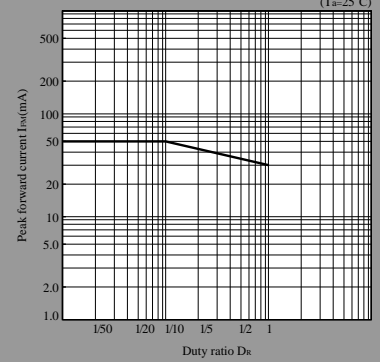

KG series

Forward Current Derating Curve

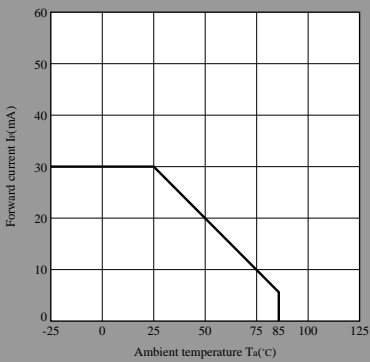

Forward Current vs. Forward Voltage(Note)

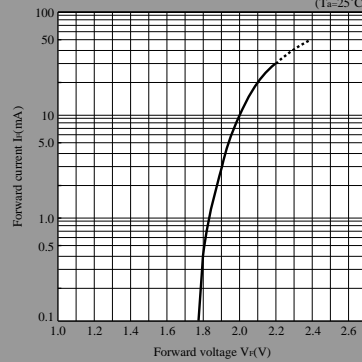

Luminous Intensity vs. Ambient Temperature(Note)

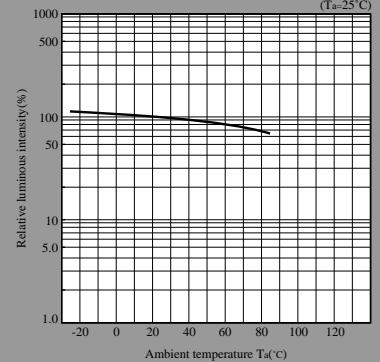

Peak Forward Current Derating Curve

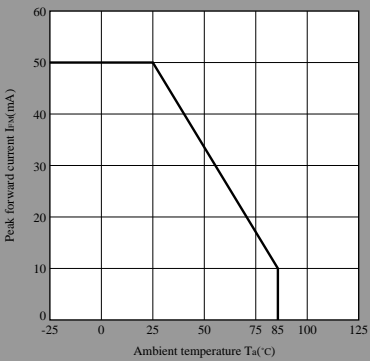

Luminous Intensity vs. Forward Current(Note)

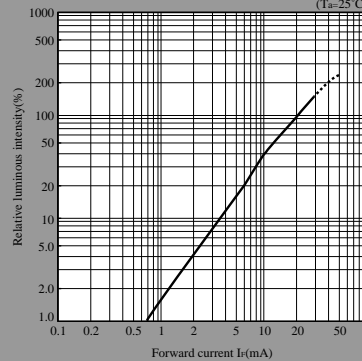

Duty Ratio vs. Peak Forward Current

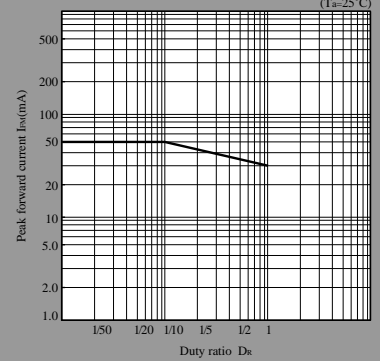

Note) Characteristics shown in diagrams are typical values. (not assurance value)

- (Notice) • In the absence of confirmation by device specification sheets, SHARP takes no responsibility for any defects that may occur in equipment using any SHARP devices shown in catalogs, data books, etc. Contact SHARP in order to obtain the latest device specification sheets before using any SHARP device.
 (Internet) • Data for sharp's optoelectronic/power device is provided for internet.(Address <http://www.sharp.co.jp/ecg/>)

TR series

Forward Current Derating Curve

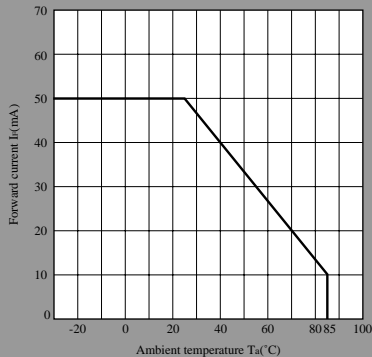

Forward Current vs. Forward Voltage(Note)

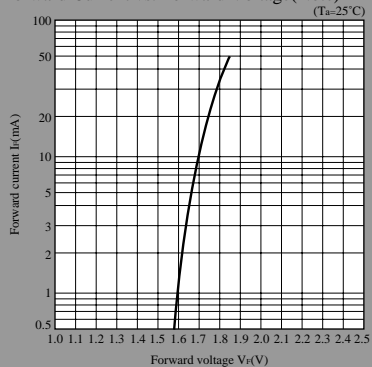

Luminous Intensity vs. Ambient Temperature(Note)

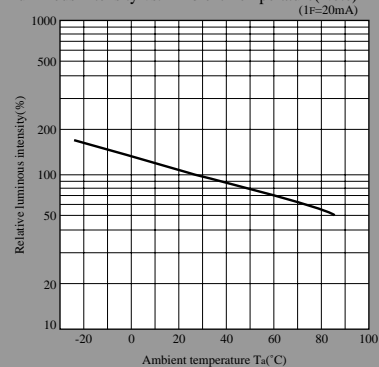

Peak Forward Current Derating Curve

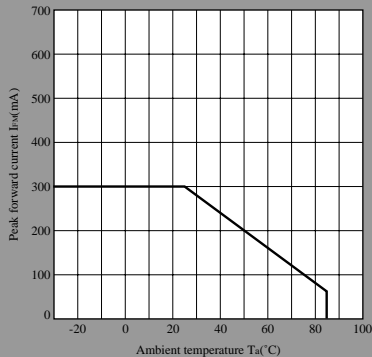

Luminous Intensity vs. Forward Current(Note)

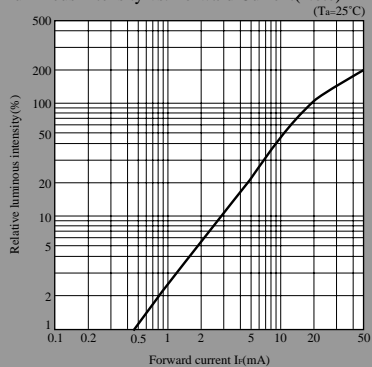

Duty Ratio vs. Peak Forward Current

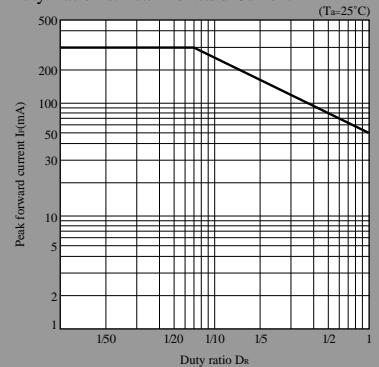

Note) Characteristics shown in diagrams are typical values. (not assurance value)