

0.4GHz to 2.7GHz High Linearity Upconverting Mixer

FEATURES

- High Output IP3: 27dBm at 0.9GHz
24.3dBm at 1.95GHz
- Low Noise Floor: -158dBm/Hz ($P_{OUT} = -5dBm$)
- High Conversion Gain: 1.4dB at 0.9GHz
- Noise Figure: 8.6dB
- Low LO-RF Leakage: -43dBm
- Single-Ended RF and LO Ports
- Low LO Drive Level: -1dBm
- Single 3.3V Supply
- 5mm × 5mm QFN24 Package
(Pin Compatible with LT5579)

APPLICATIONS

- GSM 900PCS/1800PCS and W-CDMA Infrastructure
- LTE and WiMAX Basestations
- Wireless Repeaters
- Public Safety Radios

DESCRIPTION

The LT[®]5578 mixer is a high performance upconverting mixer optimized for frequencies in the 0.4GHz to 2.7GHz range. The single-ended LO input and RF output ports simplify board layout and reduce system cost. The mixer needs only -1dBm of LO power and the balanced design results in low LO signal leakage to the RF output. At 1.95GHz operation, the LT5578 provides conversion gain of -0.7dB, high OIP3 of 24.3dBm and a low noise floor of -158dBm/Hz at a -5dBm RF output signal level.

The LT5578 offers a high performance alternative to passive mixers. Unlike passive mixers, which have conversion loss and require high LO drive levels, the LT5578 delivers conversion gain at significantly lower LO input levels and is less sensitive to LO power level variations. The lower LO drive level requirements, combined with the excellent LO leakage performance, translate into lower LO signal contamination of the output signal.

LT, LT, LTC, LTM, Linear Technology and the Linear logo are registered trademarks of Linear Technology Corporation. All other trademarks are the property of their respective owners.

TYPICAL APPLICATION

Frequency Upconversion in LTE Transmitter

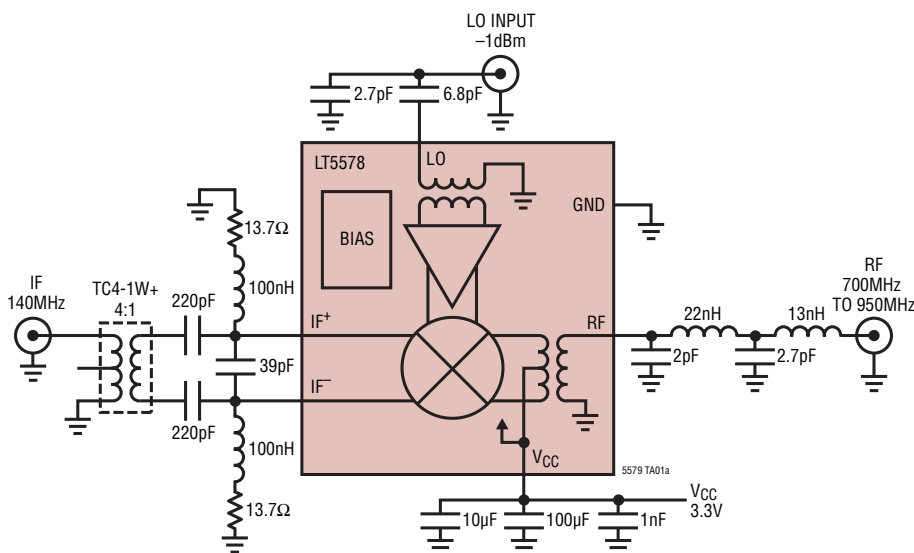

Gain, NF and OIP3 vs RF Output Frequency

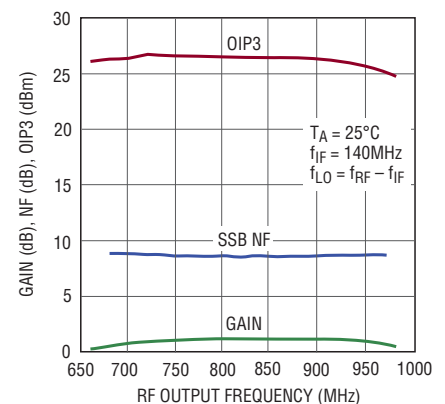

5578 TA01b

5578f

ABSOLUTE MAXIMUM RATINGS

(Note 1)

| | |
|---|----------------|
| Supply Voltage | 4V |
| LO Input Power | 10dBm |
| LO Input DC Current | 30mA |
| RF Output DC Current | 45mA |
| IF Input Power (Differential)..... | 18dBm |
| IF ⁺ , IF ⁻ DC Currents | 45mA |
| T _{JMAX} | 150°C |
| Operating Temperature Range..... | -40°C to 85°C |
| Storage Temperature Range..... | -65°C to 150°C |

PIN CONFIGURATION

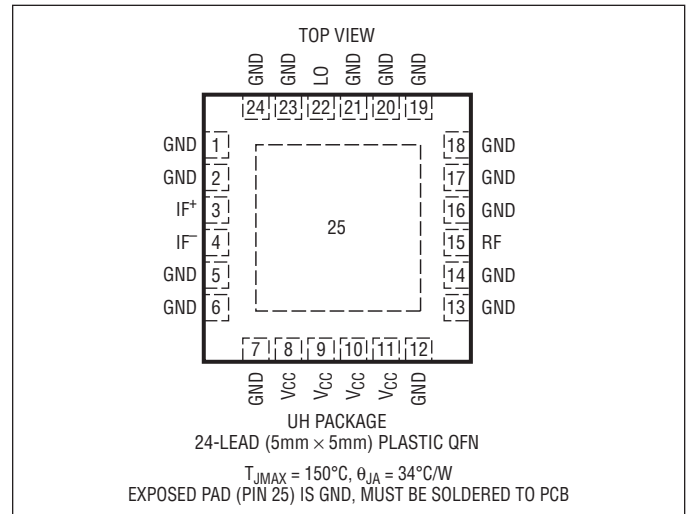

ORDER INFORMATION

| LEAD FREE FINISH | TAPE AND REEL | PART MARKING | PACKAGE DESCRIPTION | TEMPERATURE RANGE |
|------------------|-----------------|--------------|---------------------------------|-------------------|
| LT5578IUH#PBF | LT5578IUH#TRPBF | 5578 | 24-Lead (5mm × 5mm) Plastic QFN | -40°C to 85°C |

Consult LTC Marketing for parts specified with wider operating temperature ranges.

Consult LTC Marketing for information on non-standard lead based finish parts.

For more information on lead free part marking, go to: <http://www.linear.com/leadfree/>

For more information on tape and reel specifications, go to: <http://www.linear.com/tapeandreel/>

DC ELECTRICAL CHARACTERISTICS $V_{CC} = 3.3V$, $T_A = 25^\circ C$ (Note 3), unless otherwise noted.

| PARAMETER | CONDITIONS | MIN | TYP | MAX | UNITS |
|--|------------------------------------|-----|-----|-----|----------|
| Power Supply Requirements (V_{CC}) | | | | | |
| Supply Voltage | | 3.1 | 3.3 | 3.5 | V_{DC} |
| Supply Current | $V_{CC} = 3.3V$, $P_{LO} = -1dBm$ | | 152 | 170 | mA |
| | $V_{CC} = 3.5V$, $P_{LO} = -1dBm$ | | 159 | | mA |
| Input Common Mode Voltage (V_{CM}) | Internally Regulated | | 565 | | mV |

AC ELECTRICAL CHARACTERISTICS (Notes 2, 3)

| PARAMETER | CONDITIONS | MIN | TYP | MAX | UNITS |
|------------------------------------|--------------------------------|-----|-------------|-----|-------|
| IF Input Frequency Range (Note 4) | Requires Matching | | LF to 600 | | MHz |
| LO Input Frequency Range (Note 4) | Requires Matching Below 1.5GHz | | 400 to 3000 | | MHz |
| RF Output Frequency Range (Note 4) | Requires Matching | | 400 to 2700 | | MHz |

AC ELECTRICAL CHARACTERISTICS $V_{CC} = 3.3V$, $T_A = 25^\circ C$, Test circuits are shown in Figure 1. (Notes 2, 3)

| PARAMETER | CONDITIONS | MIN | TYP | MAX | UNITS |
|-----------------------|-----------------------------------|-----|---------|-----|-------|
| IF Input Return Loss | $Z_0 = 50\Omega$, External Match | | 15 | | dB |
| LO Input Return Loss | $Z_0 = 50\Omega$, External Match | | >9 | | dB |
| RF Output Return Loss | $Z_0 = 50\Omega$, External Match | | >10 | | dB |
| LO Input Power | | | -5 to 2 | | dBm |

$V_{CC} = 3.3V$, $T_A = 25^\circ C$, $P_{IF} = -5dBm$ (-5dBm/tone for 2-tone tests, $\Delta f = 1MHz$), $P_{LO} = -1dBm$, unless otherwise noted.
Low side LO for 900MHz. High side LO for 740MHz and 1950MHz. (Notes 2, 3, 4)

| PARAMETER | CONDITIONS | MIN | TYP | MAX | UNITS |
|---|--|-----|--------|-----|----------------|
| Conversion Gain | $f_{RF} = 740MHz$, $f_{IF} = 140MHz$ | | 0.8 | | dB |
| | $f_{RF} = 900MHz$, $f_{IF} = 140MHz$ | | 1.4 | | dB |
| | $f_{RF} = 1950MHz$, $f_{IF} = 240MHz$ | | -0.7 | | dB |
| Conversion Gain vs Temperature ($T_A = -40^\circ C$ to $85^\circ C$) | $f_{RF} = 740MHz$, $f_{IF} = 140MHz$ | | -0.020 | | dB/ $^\circ C$ |
| | $f_{RF} = 900MHz$, $f_{IF} = 140MHz$ | | -0.018 | | dB/ $^\circ C$ |
| | $f_{RF} = 1950MHz$, $f_{IF} = 240MHz$ | | -0.021 | | dB/ $^\circ C$ |
| Output 3rd Order Intercept | $f_{RF} = 740MHz$, $f_{IF} = 140MHz$ | | 26.5 | | dBm |
| | $f_{RF} = 900MHz$, $f_{IF} = 140MHz$ | | 27.0 | | dBm |
| | $f_{RF} = 1950MHz$, $f_{IF} = 240MHz$ | | 24.3 | | dBm |
| Output 2nd Order Intercept (LO $\pm 2IF$) | $f_{RF} = 740MHz$, $f_{IF} = 140MHz$ | | 62 | | dBm |
| | $f_{RF} = 900MHz$, $f_{IF} = 140MHz$ | | 52 | | dBm |
| | $f_{RF} = 1950MHz$, $f_{IF} = 240MHz$ | | 58 | | dBm |
| Single Sideband Noise Figure | $f_{RF} = 740MHz$, $f_{IF} = 140MHz$ | | 8.6 | | dB |
| | $f_{RF} = 900MHz$, $f_{IF} = 140MHz$ | | 8.6 | | dB |
| | $f_{RF} = 1950MHz$, $f_{IF} = 240MHz$ | | 10.5 | | dB |
| Output Noise: $P_{OUT} = -5dBm$ | $f_{RF} = 740MHz$, $f_{IF} = 140MHz$ | | -161 | | dBm/Hz |
| | $f_{RF} = 900MHz$, $f_{IF} = 140MHz$ | | -160.5 | | dBm/Hz |
| | $f_{RF} = 1950MHz$, $f_{IF} = 240MHz$ | | -158 | | dBm/Hz |
| Output Noise: $P_{OUT} = 0dBm$ | $f_{RF} = 740MHz$, $f_{IF} = 140MHz$ | | -158 | | dBm/Hz |
| | $f_{RF} = 900MHz$, $f_{IF} = 140MHz$ | | -157.5 | | dBm/Hz |
| | $f_{RF} = 1950MHz$, $f_{IF} = 240MHz$ | | -154 | | dBm/Hz |
| Output Noise: $P_{OUT} = 5dBm$ | $f_{RF} = 740MHz$, $f_{IF} = 140MHz$ | | -154 | | dBm/Hz |
| | $f_{RF} = 900MHz$, $f_{IF} = 140MHz$ | | -153 | | dBm/Hz |
| | $f_{RF} = 1950MHz$, $f_{IF} = 240MHz$ | | -149.5 | | dBm/Hz |
| Output 1dB Compression | $f_{RF} = 740MHz$, $f_{IF} = 140MHz$ | | 11.6 | | dBm |
| | $f_{RF} = 900MHz$, $f_{IF} = 140MHz$ | | 12 | | dBm |
| | $f_{RF} = 1950MHz$, $f_{IF} = 240MHz$ | | 10 | | dBm |
| IF to LO Isolation | $f_{RF} = 740MHz$, $f_{IF} = 140MHz$ | | 80 | | dB |
| | $f_{RF} = 900MHz$, $f_{IF} = 140MHz$ | | 75 | | dB |
| | $f_{RF} = 1950MHz$, $f_{IF} = 240MHz$ | | 60 | | dB |
| LO to IF Leakage | $f_{RF} = 740MHz$, $f_{IF} = 140MHz$ | | -31 | | dBm |
| | $f_{RF} = 900MHz$, $f_{IF} = 140MHz$ | | -40 | | dBm |
| | $f_{RF} = 1950MHz$, $f_{IF} = 240MHz$ | | -22 | | dBm |
| LO to RF Leakage | $f_{RF} = 740MHz$, $f_{IF} = 140MHz$ | | -43 | | dBm |
| | $f_{RF} = 900MHz$, $f_{IF} = 140MHz$ | | -43 | | dBm |
| | $f_{RF} = 1950MHz$, $f_{IF} = 240MHz$ | | -46 | | dBm |

Note 1: Stresses beyond those listed under Absolute Maximum Ratings may cause permanent damage to the device. Exposure to any Absolute Maximum Rating condition for extended periods may affect device reliability and lifetime.

Note 2: Each set of frequency conditions requires appropriate matching (see Figure 1).

Note 3: The LT5578 is guaranteed functional over the operating temperature range from $-40^\circ C$ to $85^\circ C$.

Note 4: SSB noise figure measurements performed with a small-signal noise source and bandpass filter on LO signal generator. No other IF signal applied.

TYPICAL DC PERFORMANCE CHARACTERISTICS (Test Circuit Shown in Figure 1)

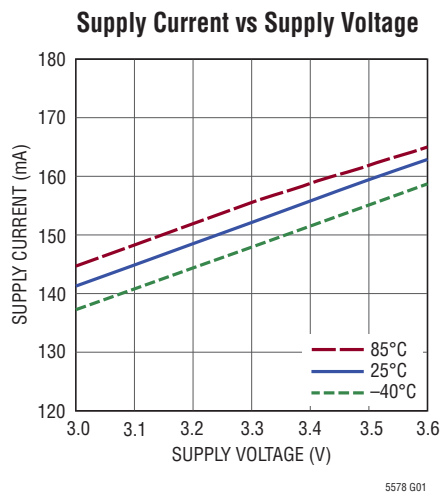

TYPICAL AC PERFORMANCE CHARACTERISTICS 900MHz Application: $V_{CC} = 3.3V$, $T_A = 25^\circ C$, $f_{IF} = 140MHz$, $P_{IF} = -5dBm$ (-5dBm/tone for 2-tone tests, $\Delta f = 1MHz$), low side LO, $P_{LO} = -1dBm$, output measured at 900MHz, unless otherwise noted. (Test circuit shown in Figure 1)

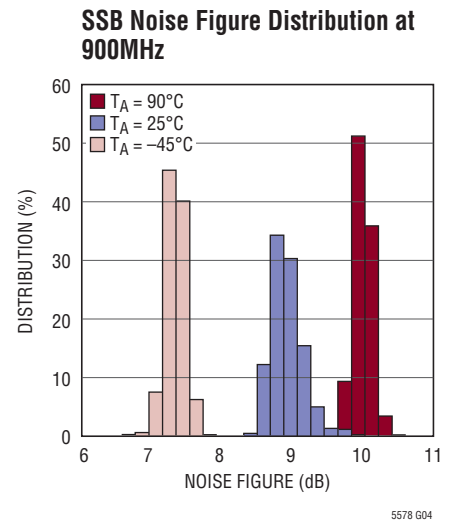
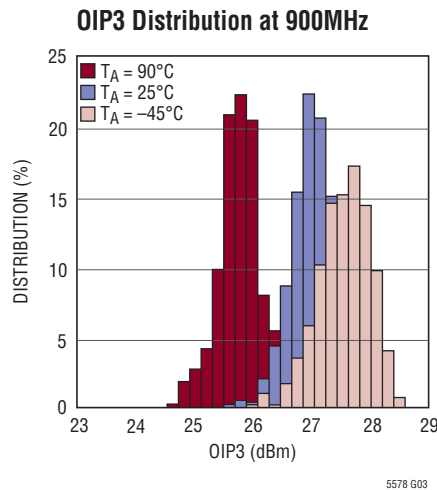
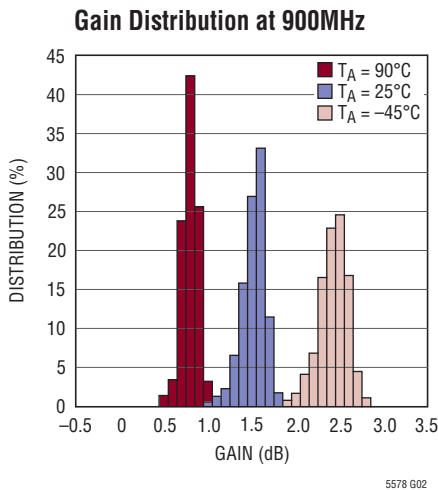

TYPICAL AC PERFORMANCE CHARACTERISTICS 740MHz Application:

$V_{CC} = 3.3V$, $T_A = 25^\circ C$, $f_{IF} = 140MHz$, $P_{IF} = -5dBm$ (-5dBm/tone for 2-tone tests, $\Delta f = 1MHz$), high side LO, $P_{LO} = -1dBm$, output measured at 740MHz, unless otherwise noted. (Test circuit shown in Figure 1)

Conversion Gain and OIP3 vs RF Output Frequency

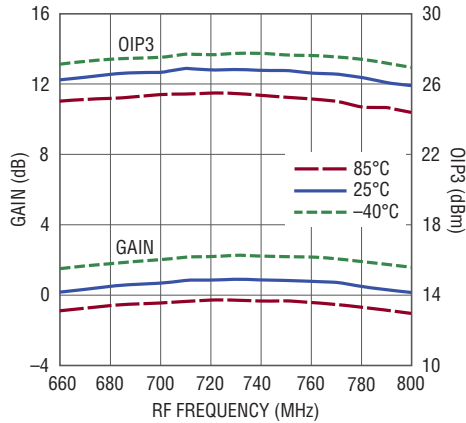

5578 G05

SSB Noise Figure vs RF Output Frequency

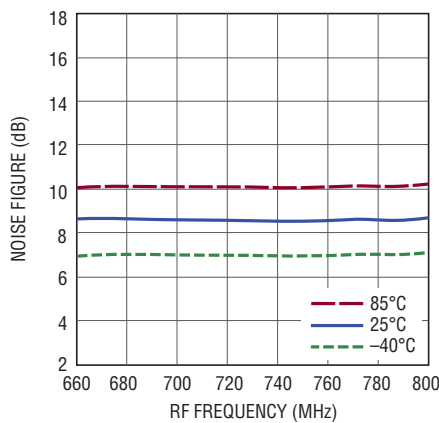

5578 G06

LO-RF Leakage vs RF Output Frequency

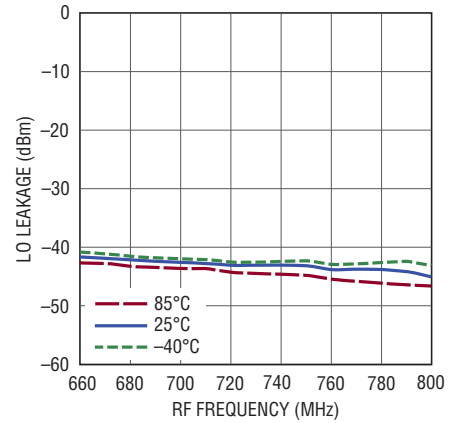

5578 G07

Conversion Gain and OIP3 vs LO Input Power

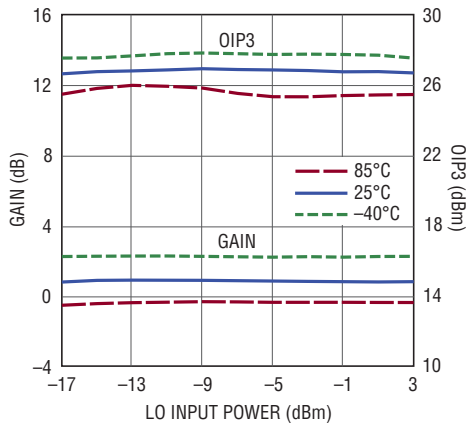

5578 G08

SSB Noise Figure vs LO Input Power

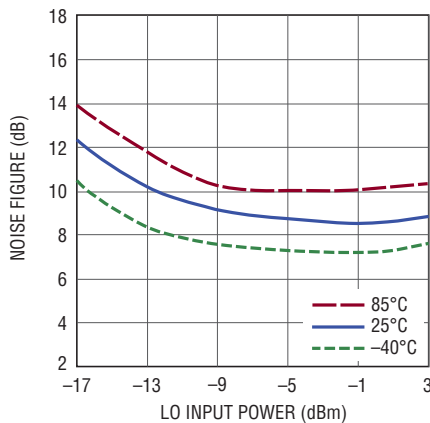

5578 G09

Conversion Gain and OIP3 vs Supply Voltage

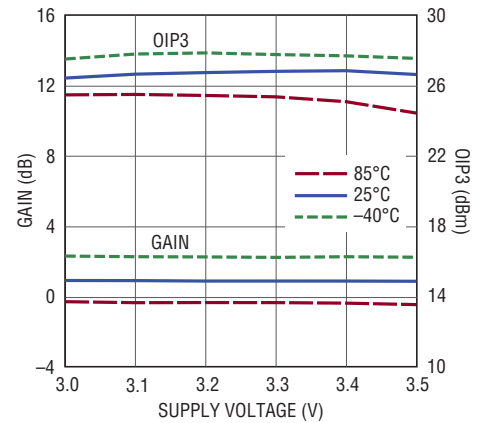

5578 G10

IM3 Level vs RF Output Power (2-Tone)

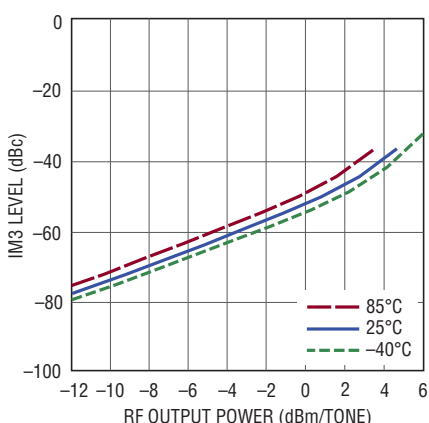

5578 G11

IM2 Level vs RF Output Power (1-Tone)

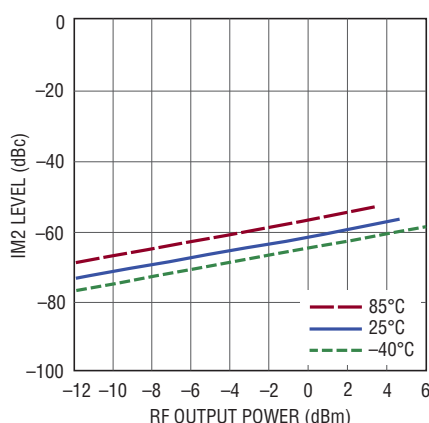

5578 G12

SSB Noise Figure vs Supply Voltage

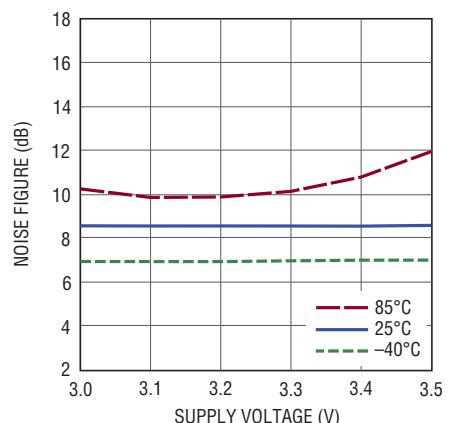

5578 G13

5578f

TYPICAL AC PERFORMANCE CHARACTERISTICS 900MHz Application:

$V_{CC} = 3.3V$, $T_A = 25^\circ C$, $f_{IF} = 140MHz$, $P_{IF} = -5dBm$ (-5dBm/tone for 2-tone tests, $\Delta f = 1MHz$), low side LO, $P_{LO} = -1dBm$, output measured at 900MHz, unless otherwise noted. (Test circuit shown in Figure 1)

Conversion Gain and OIP3 vs RF Output Frequency

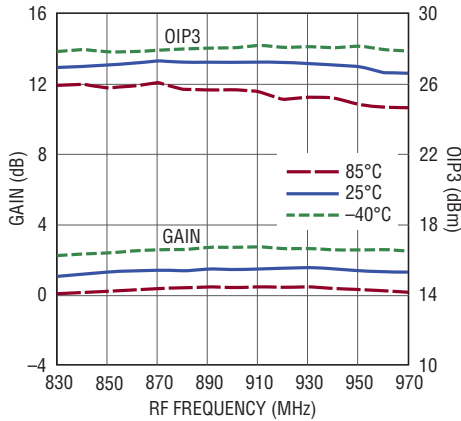

5578 G14

SSB Noise Figure vs RF Output Frequency

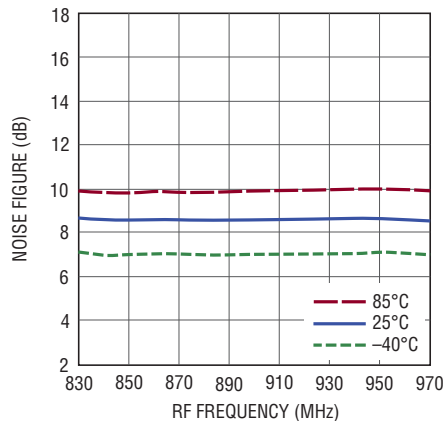

5578 G15

LO-RF Leakage vs RF Output Frequency

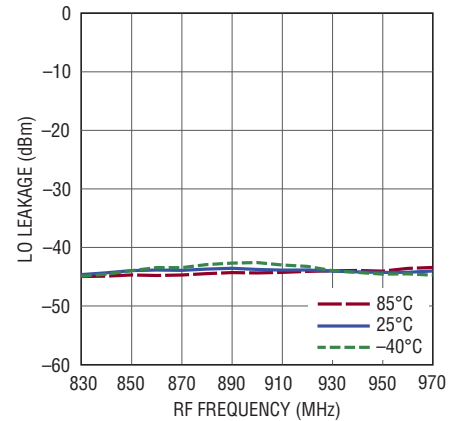

5578 G16

Conversion Gain and OIP3 vs LO Input Power

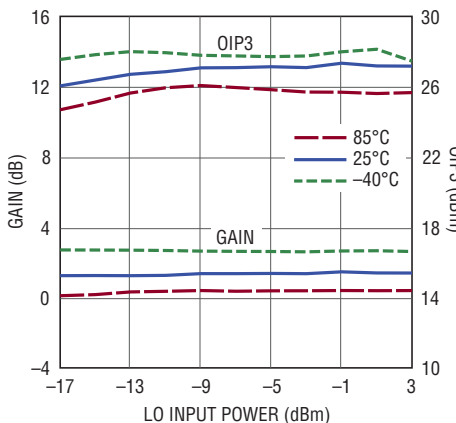

5578 G17

SSB Noise Figure vs LO Input Power

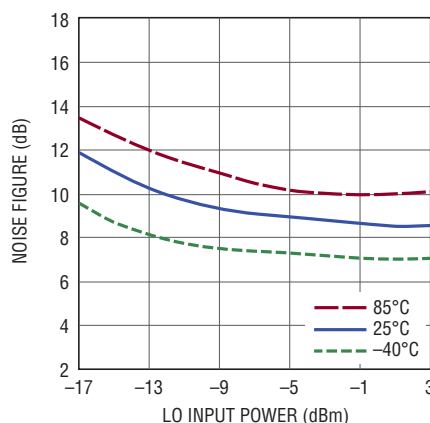

5578 G18

Conversion Gain and OIP3 vs Supply Voltage

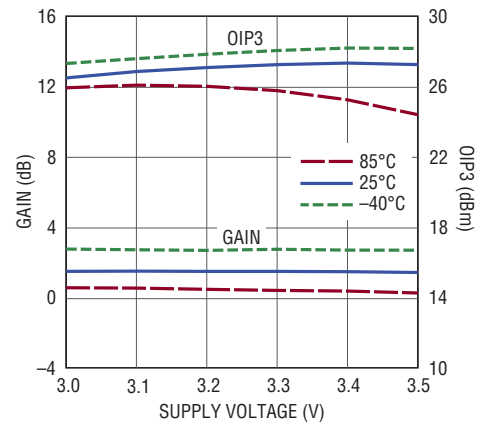

5578 G19

IM3 Level vs RF Output Power (2-Tone)

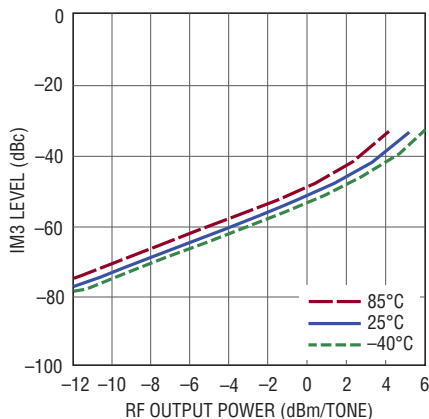

5578 G20

IM2 Level vs RF Output Power (1-Tone)

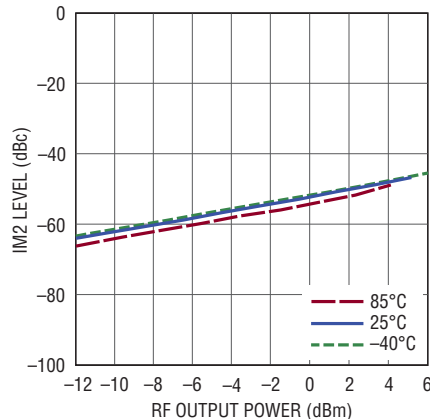

5578 G21

SSB Noise Figure vs Supply Voltage

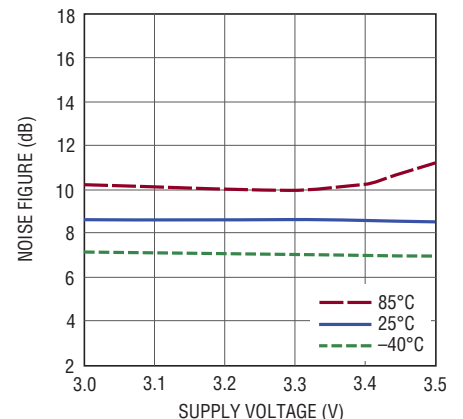

5578 G22
5578f

TYPICAL PERFORMANCE CHARACTERISTICS 1950MHz Application:

$V_{CC} = 3.3V$, $T_A = 25^\circ C$, $f_{IF} = 240MHz$, $P_{IF} = -5dBm$ (-5dBm/tone for 2-tone tests, $\Delta f = 1MHz$), high side LO, $P_{LO} = -1dBm$, output measured at 1950MHz, unless otherwise noted. (Test circuit shown in Figure 1)

Conversion Gain and OIP3 vs RF Output Frequency

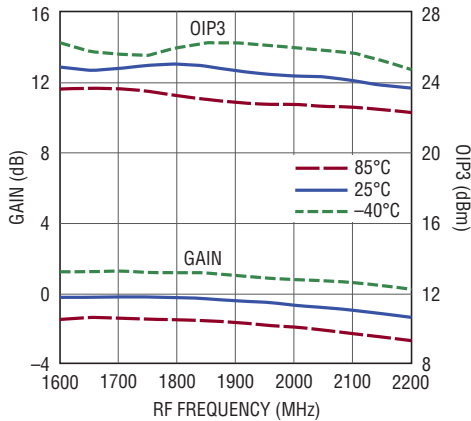

5578 G23

SSB Noise Figure vs RF Output Frequency

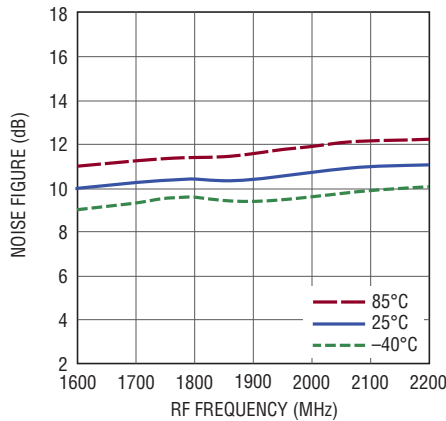

5578 G24

LO-RF Leakage vs RF Output Frequency

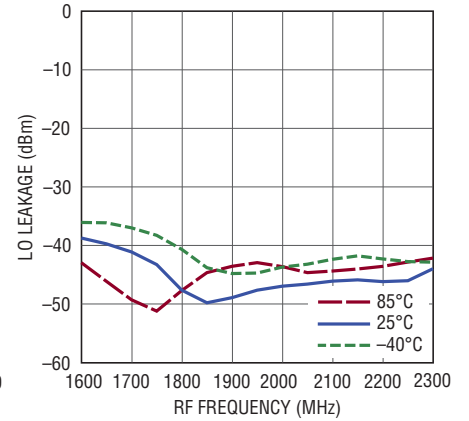

5578 G25

Conversion Gain and OIP3 vs LO Input Power

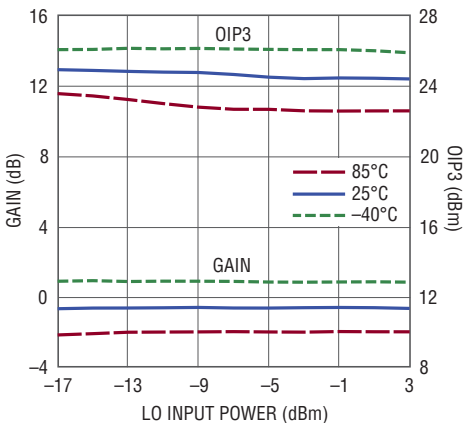

5578 G26

SSB Noise Figure vs LO Input Power

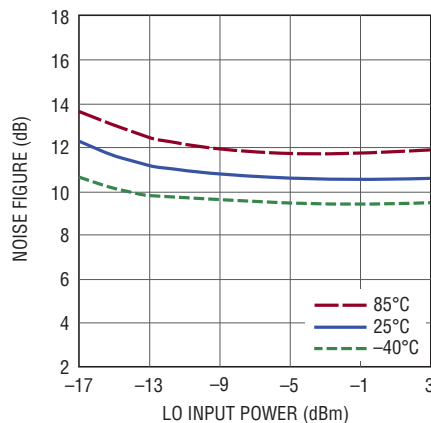

5578 G27

Conversion Gain and OIP3 vs Supply Voltage

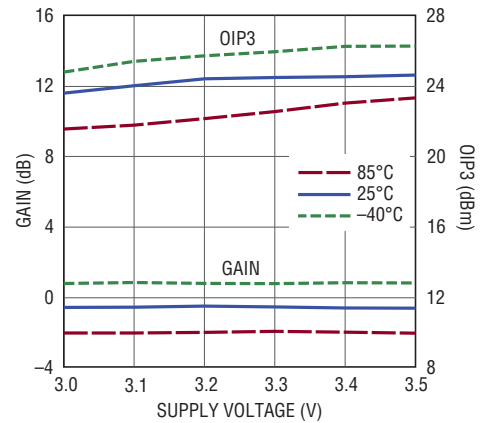

5578 G28

IM3 Level vs RF Output Power (2-Tone)

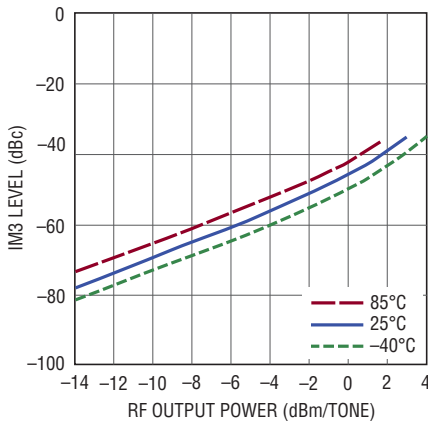

5578 G29

IM2 Level vs RF Output Power (1-Tone)

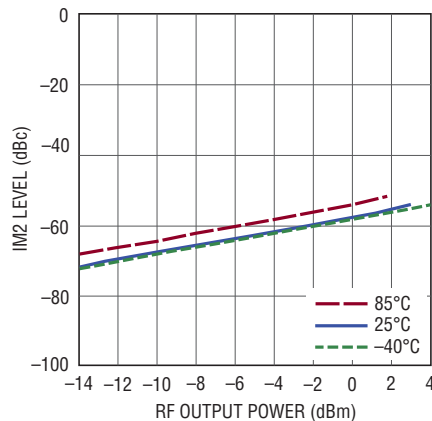

5578 G30

SSB Noise Figure vs Supply Voltage

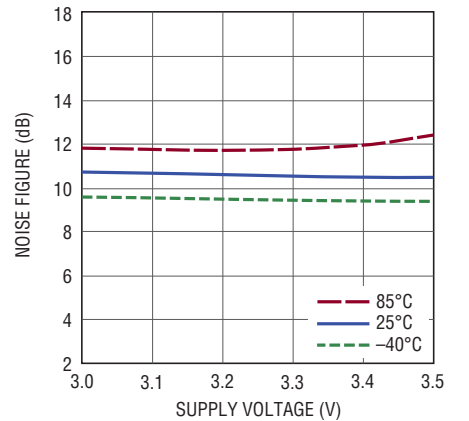

5578 G31

5578f

PIN FUNCTIONS

GND (Pins 1, 2, 5-7, 12-14, 16-21, 23, 24): Ground Connections. These pins are internally connected to the exposed pad and should be soldered to a low impedance RF ground on the printed circuit board.

IF⁺, IF⁻ (Pins 3, 4): Differential IF Input. The common mode voltage on these pins is set internally to 565mV. The DC current from each pin is determined by the value of an external resistor to ground. The maximum DC current through each pin is 45mA.

V_{CC} (Pins 8-11): Power Supply Pins for the IC. These pins are connected together internally. Typical current consumption is 152mA. These pins should be connected together on the circuit board with external bypass capacitors of 1000pF, 100pF and 10pF located as close to the pins as possible.

RF (Pin 15): Single-Ended RF Output. This pin is connected to an internal transformer winding. The opposite end of the winding is grounded internally. An impedance transformation may be required to match the output and a DC decoupling capacitor is required if the following stage has a DC bias voltage present.

LO (Pin 22): Single-Ended Local Oscillator Input. An internal series capacitor acts as a DC block to this pin.

Exposed Pad (Pin 25): PGND. Electrical and thermal ground connection for the entire IC. This pad must be soldered to a low impedance RF ground on the printed circuit board. This ground must also provide a path for thermal dissipation.

BLOCK DIAGRAM

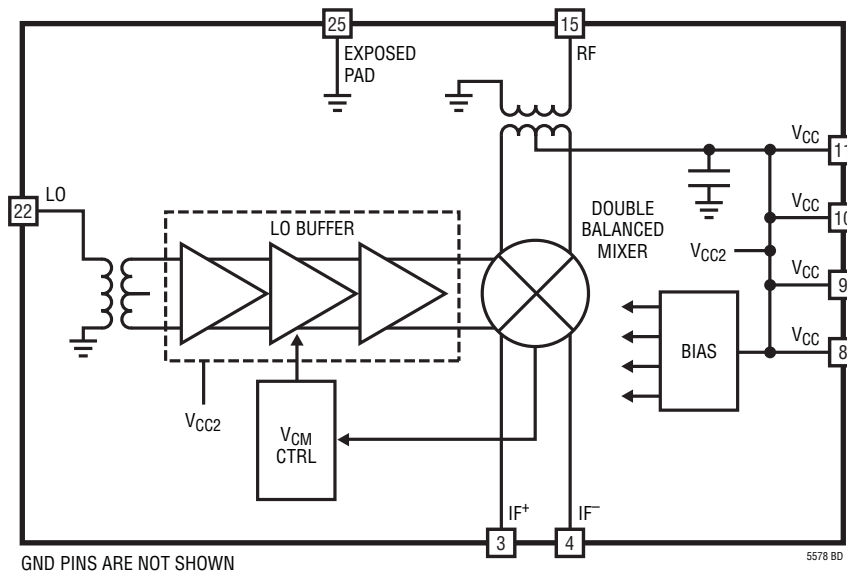

TEST CIRCUIT

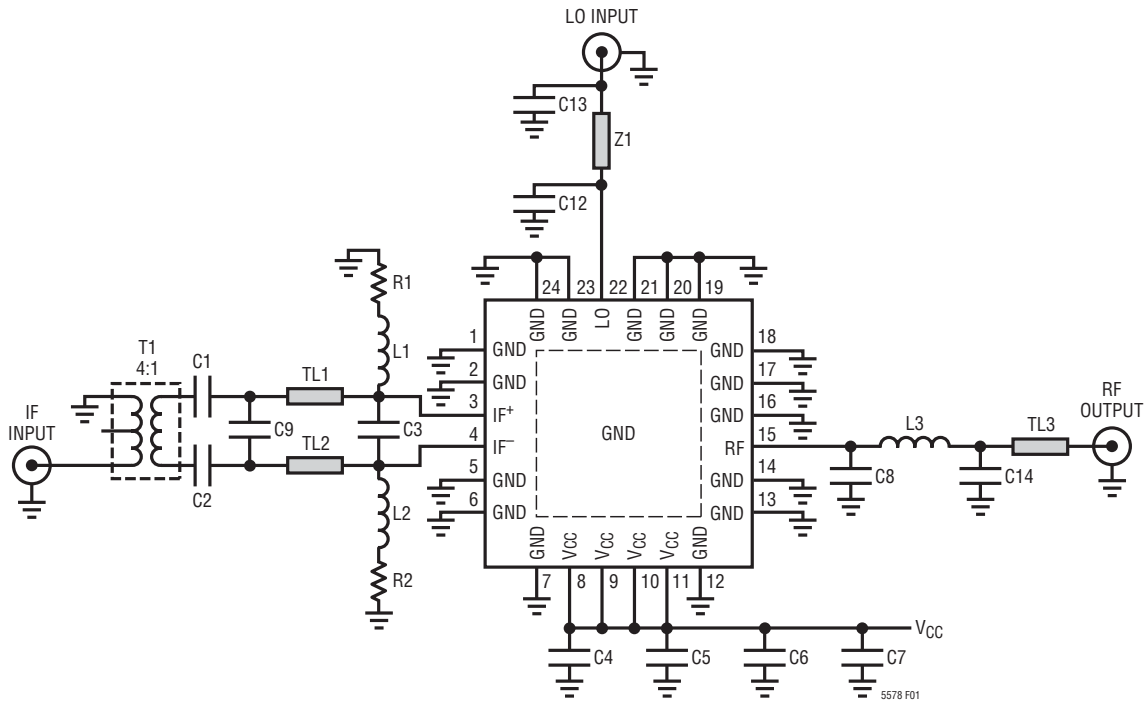

| REF DES | $f_{RF} = 740\text{MHz}$ $f_{IF} = 140\text{MHz}$ $f_{LO} = 880\text{MHz}$ | $f_{RF} = 900\text{MHz}$ $f_{IF} = 140\text{MHz}$ $f_{LO} = 760\text{MHz}$ | $f_{RF} = 1950\text{MHz}$ $f_{IF} = 240\text{MHz}$ $f_{LO} = 2190\text{MHz}$ | SIZE | COMMENTS |
|-----------|--|--|--|---------|---------------------------|
| C1, C2 | 220pF | 220pF | 82pF | 0402 | AVX |
| C3 | - | - | 4.7pF | 0402 | AVX |
| C4 | 100pF | 100pF | 100pF | 0402 | AVX |
| C5 | 10pF | 10pF | 10pF | 0402 | AVX |
| C6 | 1nF | 1nF | 1nF | 0402 | AVX |
| C7 | 1μF | 1μF | 1μF | 0603 | Taiyo Yuden LMK107BJ105MA |
| C8 | 3.3pF | 1.8pF | - | 0402 | AVX ACCU-P |
| C9 | 39pF | 39pF | 33pF | 0402 | AVX |
| C12 | - | - | - | 0402 | |
| C13 | - | 2.7pF | - | 0402 | |
| C14 | - | - | 1.2pF | 0402 | |
| L1, L2 | 100nH | 100nH | 100nH | 0603 | Coilcraft 0603CS |
| L3 | 18nH | 12nH | 1.8nH | 0402 | Toko LL1005-FHL |
| R1, R2 | 13.7, 0.1% | 13.7, 0.1% | 13.7, 0.1% | 0603 | IRC PFC-W0603LF-02-13R7-B |
| T1 | 4:1 | 4:1 | 4:1 | AT224-1 | Mini-Circuits TC4-1W+ |
| TL1, TL2* | - | - | 1.9mm | - | $Z_0 = 70\Omega$ |
| TL3 | 2.3mm | 2.3mm | 1.3mm | - | $Z_0 = 70\Omega$ |
| Z1 | 2.6pF | 6.8pF | 0Ω | 0402 | AVX/0Ω Jumper |

*Center-to-center spacing between C9 and C3. Center of C9 is 3.0mm from the edge of the package.

Figure 1. Test Circuit Schematic and Component Values

APPLICATIONS INFORMATION

The LT5578 uses a high performance LO buffer amplifier driving a double-balanced mixer core to achieve frequency conversion with high linearity. Internal baluns are used to provide single-ended LO input and RF output ports. The IF input is differential. The LT5578 is intended for operation in the 0.4GHz to 2.7GHz frequency range, though operation outside this range is possible with reduced performance.

IF Input Interface

The IF inputs are tied to the emitters of the double-balanced mixer transistors, as shown in Figure 2. These pins are internally biased to a common mode voltage of 565mV. The optimum DC current in the mixer core is approximately 40mA per side, and is set by the external resistors, R1 and R2. The inductors and resistors must be able to handle the anticipated current and power dissipation. For best LO leakage performance the board layout must be symmetrical and the input resistors should be well matched (0.1% tolerance is recommended).

The purpose of the inductors (L1 and L2) is to reduce the loading effects of R1 and R2. The impedances of L1 and L2 should be at least several times greater than the IF input impedance at the desired IF frequency. The self-resonant frequency of the inductors should also be at least several times the IF frequency. Note that the DC resistances of L1 and L2 will affect the DC current and should be accounted for in the selection of R1 and R2.

L1 and L2 should connect to the signal lines as close to the package as possible. This location will be at the lowest impedance point, which will minimize the sensitivity of the performance to the loading of the shunt L-R branches.

Capacitors C1 and C2 are used to cancel out the parasitic series inductance of the IF transformer. They also provide DC isolation between the IF ports to prevent unwanted interactions that can affect the LO to RF leakage performance.

The differential input resistance to the mixer is approximately 10Ω, as indicated in Table 1. The package and external inductances (TL1 and TL2) are used along with C9 to step the impedance up to about 12.5Ω. At lower frequencies additional series inductance may be required between the IF ports and C9. The position of C9 may vary with the IF frequency due to the different series inductance requirements. The 4:1 impedance ratio of transformer T1 completes the transformation to 50Ω. Table 1 lists the differential IF input impedances and reflection coefficients for several frequencies.

Table 1. IF Input Differential Impedance

| FREQUENCY (MHz) | IF INPUT IMPEDANCE | REFLECTION COEFFICIENT | |
|-----------------|--------------------|------------------------|-------|
| | | MAG | ANGLE |
| 70 | 10.0 + j1.1 | 0.666 | 177.4 |
| 140 | 10.2 + j1.5 | 0.661 | 176.5 |
| 170 | 8.7 + j1.8 | 0.705 | 175.7 |
| 190 | 8.7 + j2.0 | 0.705 | 175.2 |
| 240 | 8.7 + j2.5 | 0.705 | 174.0 |
| 380 | 8.7 + j3.9 | 0.704 | 170.9 |
| 450 | 8.7 + j4.5 | 0.705 | 169.3 |
| 750 | 9.6 + j7.6 | 0.683 | 162.0 |
| 1000 | 9.8 + j10.3 | 0.685 | 155.9 |

The purpose of capacitor C3 is to improve the LO-RF leakage in some applications. This relatively small-valued capacitor has little effect on the impedance match in most cases. This capacitor should typically be located close to the IC, however, there may be cases where re-positioning the capacitor will improve performance.

The measured return loss of the IF input is shown in Figure 3 for application frequencies of 70MHz, 140MHz and 240MHz. Component values are listed in Table 2. All of the applications use L1 = L2 = 100nH, R1 = R2 = 13.7Ω

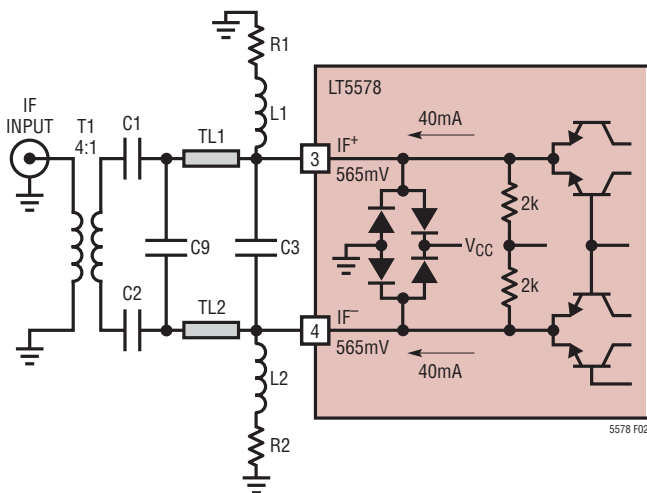

Figure 2. IF Input with External Matching

APPLICATIONS INFORMATION

and T1 = TC4-1W+. The 70MHz match was not used for 140MHz characterization because it requires the addition of two inductors.

Table 2. IF Input Component Values

| FREQUENCY (MHz) | C1, C2 (pF) | C9 (pF) | C3 (pF) | TL1, TL2 (nH) | MATCH BW (at 12dB RL) |
|-----------------|-------------|---------|---------|---------------|-----------------------|
| 70 | 560 | 82 | – | 3.3 | 50-215 |
| 140 | 220 | 39 | – | – | 98-187 |
| 240 | 82 | 33 | 4.7 | – | 175-295 |

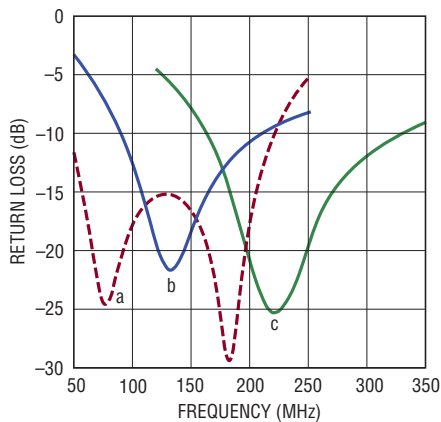

5578 F03

Figure 3. IF Input Return Loss with 70MHz (a), 140MHz (b) and 240MHz (c) Matching

LO Input Interface

The simplified schematic for the single-ended LO input port is shown in Figure 4. An internal transformer provides a broadband impedance match and performs single-ended to differential conversion. The primary winding is internally grounded, thus an external DC block may be necessary in some applications. The transformer secondary feeds the differential limiting amplifier stages that drive the mixer core.

The measured return loss of the LO input port is shown in Figure 5 for different application frequencies. The impedance match is acceptable from about 1.5GHz to beyond 3GHz, with a minimum return loss across this range of about 9dB. Below 1.5GHz, external components are used to tune the impedance match to the desired frequency.

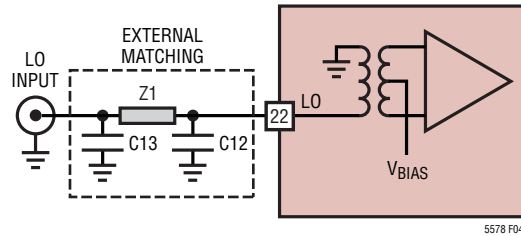

5578 F04

Figure 4. LO Input Circuit

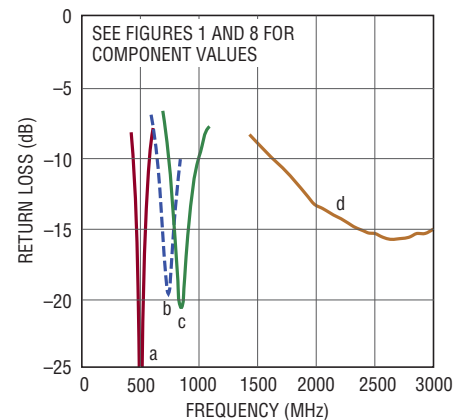

5578 F05

Figure 5. LO Input Return Loss with 520MHz (a), 760MHz (b), 880MHz (c) and >1.5GHz (d) Matching

Table 3 lists the input impedance and reflection coefficient vs frequency for the LO input for use in such cases.

Table 3. Single-Ended LO Input Impedance (at Pin 22, No External Match)

| FREQUENCY (MHz) | LO INPUT IMPEDANCE | REFLECTION COEFFICIENT | |
|-----------------|--------------------|------------------------|--------|
| | | MAG | ANGLE |
| 300 | 41.7 j20.3 | 0.747 | 142.8 |
| 600 | 95.0 j42.7 | 0.657 | 105.5 |
| 900 | 126 j84.2 | 0.558 | 67.6 |
| 1200 | 127 j239 | 0.456 | 27.6 |
| 1500 | 104 -j686 | 0.353 | -10.8 |
| 1800 | 74.0 -j188 | 0.247 | -48.3 |
| 2100 | 52.5 -j162 | 0.158 | -90.0 |
| 2400 | 42.3 -j459 | 0.097 | -152.0 |
| 2700 | 44.4 j249 | 0.111 | 127.5 |
| 3000 | 52.4 j161 | 0.159 | 90.6 |

5578f

APPLICATIONS INFORMATION

RF Output Interface

The RF output interface is shown in Figure 6. An internal RF transformer reduces the mixer core output impedance to simplify matching of the RF output pin. A center tap in the transformer provides the DC connection to the mixer core and the transformer provides DC isolation to the RF output. The RF pin is internally grounded through the secondary winding of the transformer, thus a DC voltage should not be applied to this pin.

While the LT5578 performs best at frequencies above 700MHz, the part can be used down to 400MHz. The low inductance of the internal transformer limits the performance at lower frequencies. The impedance data for the RF output, listed in Table 4, can be used to develop matching networks for different frequencies or load impedances. Figure 7 illustrates the output return loss performance for several applications. The component values and approximate matching bandwidths are listed in Table 5.

DC and RF Grounding

The LT5578 relies on the back side ground for both RF and thermal performance. The Exposed Pad must be soldered to the low impedance topside ground plane of

the board. As many vias as possible should connect the topside ground to other ground layers to aid in thermal dissipation and reduce inductance.

Table 4. Single-Ended RF Output Impedance (at Pin 15, No External Matching)

| FREQUENCY (MHz) | RF OUTPUT IMPEDANCE | REFLECTION COEFFICIENT | |
|-----------------|---------------------|------------------------|--------|
| | | MAG | ANGLE |
| 400 | 10.1 + j29.3 | 0.741 | 117.6 |
| 800 | 90.8 + j96.6 | 0.614 | 32.6 |
| 1200 | 69.7 – j66.6 | 0.507 | -44.4 |
| 1600 | 32.8 – j22.5 | 0.330 | -112.3 |
| 2000 | 32.3 – j5.4 | 0.225 | -159.3 |
| 2400 | 28.6 + j0.3 | 0.273 | 179.0 |
| 2800 | 22.5 + j4.4 | 0.384 | 167.3 |

Table 5. RF Output Component Values

| FREQUENCY (MHz) | C8 (pF) | L3 (nH) | C14 (pF) | MATCH BW (at 12dB RL) |
|-----------------|---------|---------|----------|-----------------------|
| 450 | 9.0 | 18 | – | 430-505 |
| 740 | 3.3 | 18 | – | 680-768 |
| 900 | 1.8 | 12 | – | 835-970 |
| 1950 | – | 1.8 | 1.2 | 1765-2305 |
| 2600 | – | 0Ω | 0.8 | 2150-2990 |

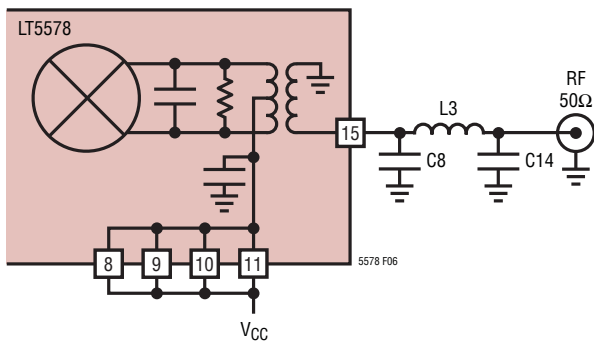

Figure 6. RF Output Circuit

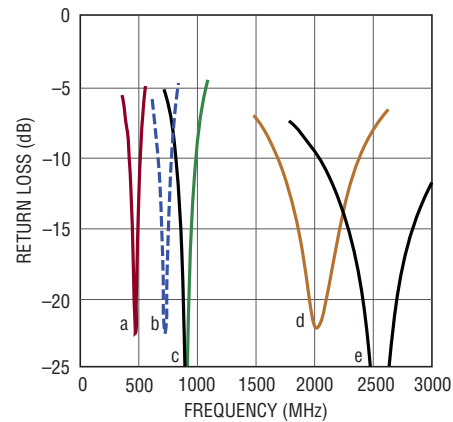

Figure 7. RF Output Return Loss with 450MHz (a), 740MHz (b), 900MHz (c), 1950MHz (d) and 2600MHz (e) Matching

TYPICAL APPLICATIONS

The following examples illustrate the implementation and performance of the LT5578 in some selected applications. These circuits were evaluated using the board layout shown in Figure 12.

450MHz Application

In this case, the LT5578 was evaluated for an application with an IF input at 70MHz, an RF output of 450MHz and a high side LO. The LO port is tuned for high side LO injection at 520MHz. The matching networks for the three ports are shown in Figure 8.

At the IF input, the 560pF capacitors are used mainly as DC blocks, but also help tune out the parasitic inductance of the transformer. The 82pF differential capacitor and 3.3nH chip inductors provide an impedance transformation between the IF input pins and the transformer. The relatively low input frequency requires the use of chip inductors instead of the short transmission lines that are shown in Figure 2. The measured IF port return loss is included in Figure 3.

The RF port impedance match is realized with a shunt 12pF capacitor and a series 18nH inductor. The return loss with this configuration is better than 12dB from about 430MHz to 505MHz and is plotted in Figure 7.

To tune the LO port, a series 6.8pF and shunt 4.7pF capacitor are used as shown. This combination provides a 10dB, or better, return loss from 435MHz to 580MHz as shown in Figure 5. The series capacitor also provides DC decoupling for the internal transformer at the LO input.

Figure 9 shows measured conversion gain, noise figure and OIP3 as a function of RF output frequency. At 450MHz, the gain is -2.1dB with a NF of 9.3dB and an OIP3 of 23.8dBm.

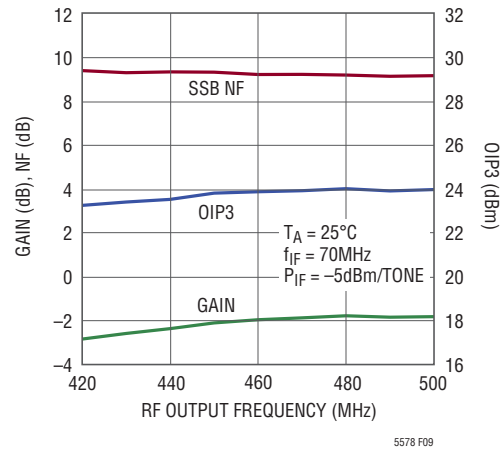

Figure 9. Gain, Noise Figure and OIP3 vs RF Frequency in the 450MHz Application

2600MHz Application

For this application, the impedance match of the RF port is optimized at 2600MHz and has a good return loss over the range of 2200MHz to 2900MHz. The component values are listed in Table 5 and typical output return loss is shown in Figure 7. The IF input is matched at 240MHz as described in Table 2. The LO port requires no external matching for this band as its return loss is good for frequencies above 1.5GHz.

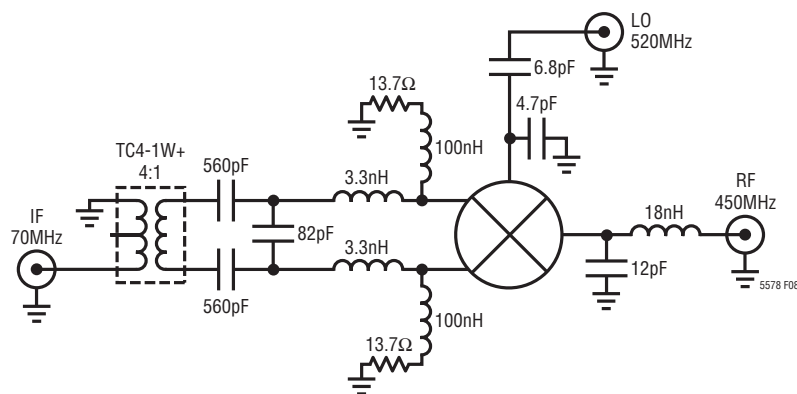

Figure 8. Schematic for 450MHz RF Application with 70MHz IF and 520MHz LO

TYPICAL APPLICATIONS

The measured room temperature performance is plotted in Figure 10 for both low side and high side LO drive. At 2600MHz, the gain is approximately -2.8dB with a noise figure of 11.2dB and OIP3 of about 22.2dBm. Low side LO yields slightly better overall performance than high side LO.

700 to 950 MHz Output Matching

The application shown on page 1 has a wider bandwidth than the 740MHz and 900MHz configurations. Using two additional components at the RF output allows the band-

width to be extended to cover the range from 700MHz to 950MHz. Figure 11 compares the broadband return loss to the typical 740MHz and 900MHz return loss performance.

The swept gain, noise figure and OIP3 results are plotted on page 1 for an IF of 140MHz and a low side LO. The conversion gain is greater than 0.7dB across the band with OIP3 better than 25.5dBm. The single side-band noise figure is less than 8.8dB across the band.

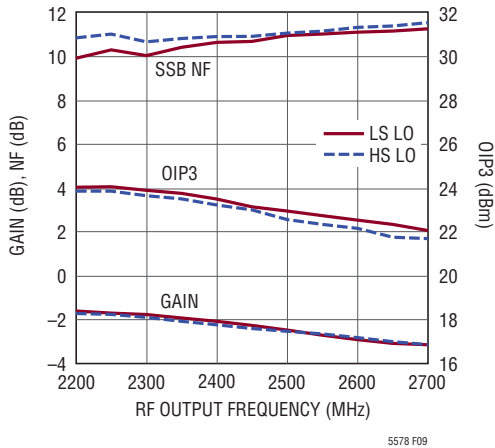

Figure 10. Gain, Noise Figure and OIP3 vs RF Frequency for the 2600MHz Application

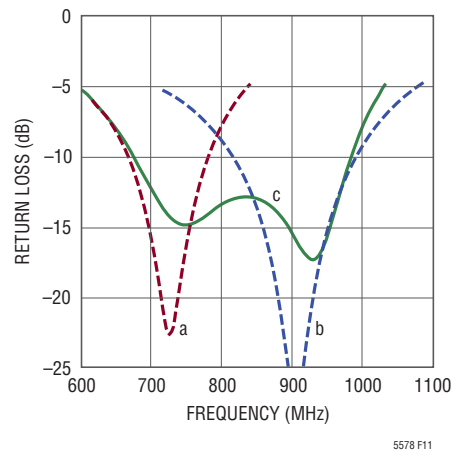

Figure 11. Return Loss Comparison: 740MHz (a), 900MHz (b) and 700MHz to 950MHz (c)

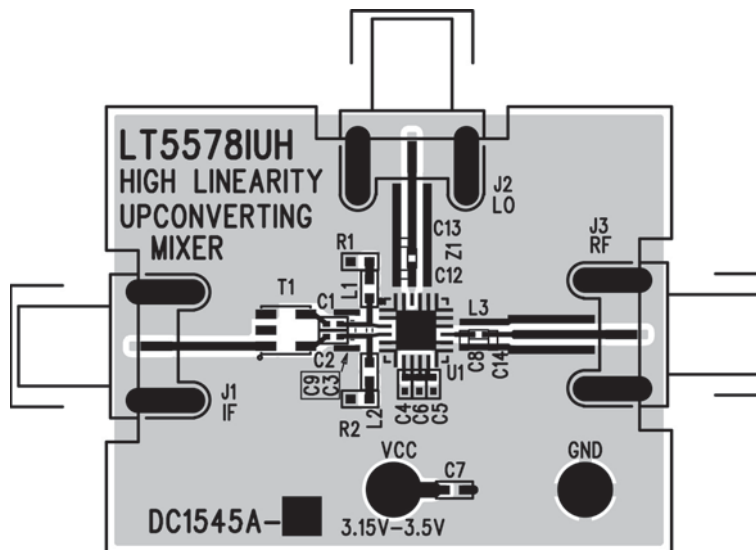
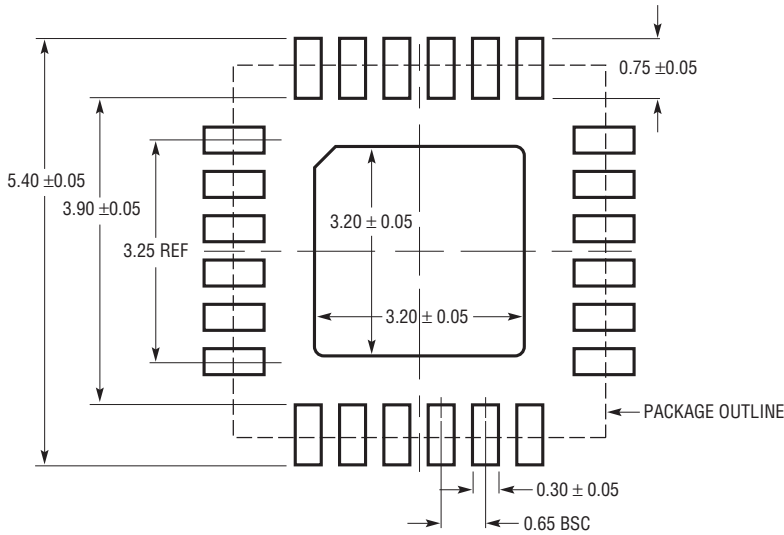

Figure 12. LT5578 Evaluation Board (DC1545A)

PACKAGE DESCRIPTION

UH Package
24-Lead Plastic QFN (5mm × 5mm)
 (Reference LTC DWG # 05-08-1747 Rev A)



RECOMMENDED SOLDER PAD LAYOUT
 APPLY SOLDER MASK TO AREAS THAT ARE NOT SOLDERED

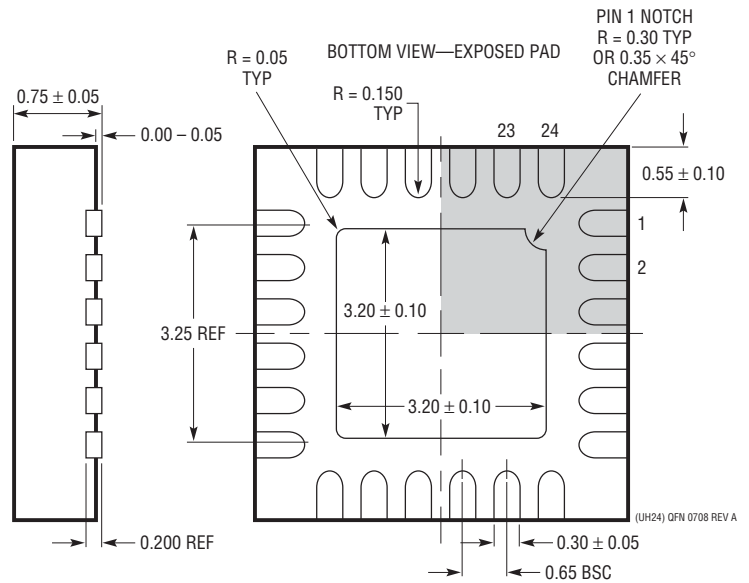
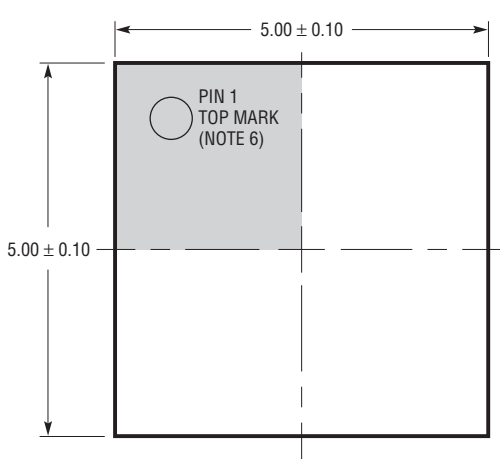

- NOTE:
1. DRAWING IS NOT A JEDEC PACKAGE OUTLINE
 2. DRAWING NOT TO SCALE
 3. ALL DIMENSIONS ARE IN MILLIMETERS
 4. DIMENSIONS OF EXPOSED PAD ON BOTTOM OF PACKAGE DO NOT INCLUDE MOLD FLASH. MOLD FLASH, IF PRESENT, SHALL NOT EXCEED 0.20mm ON ANY SIDE
 5. EXPOSED PAD SHALL BE SOLDER PLATED
 6. SHADED AREA IS ONLY A REFERENCE FOR PIN 1 LOCATION ON THE TOP AND BOTTOM OF PACKAGE

RELATED PARTS

| PART NUMBER | DESCRIPTION | COMMENTS |
|---------------------------|---|--|
| Infrastructure | | |
| LT5514 | Ultralow Distortion, IF Amplifier/ADC Driver with Digitally Controlled Gain | 850MHz Bandwidth, 47dBm OIP3 at 100MHz, 10.5dB to 33dB Gain Control Range |
| LT5517 | 40MHz to 900MHz Quadrature Demodulator | 21dBm IIP3, Integrated LO Quadrature Generator |
| LT5518 | 1.5GHz to 2.4GHz High Linearity Direct Quadrature Modulator | 22.8dBm OIP3 at 2GHz, -158.2dBm/Hz Noise Floor, 50Ω Single-Ended RF and LO Ports, 4-Channel W-CDMA ACPR = -64dBc at 2.14GHz |
| LT5519 | 0.7GHz to 1.4GHz High Linearity Upconverting Mixer | 17.1dBm IIP3 at 1GHz, Integrated RF Output Transformer with 50Ω Matching, Single-Ended LO and RF Ports Operation |
| LT5520 | 1.3GHz to 2.3GHz High Linearity Upconverting Mixer | 15.9dBm IIP3 at 1.9GHz, Integrated RF Output Transformer with 50Ω Matching, Single-Ended LO and RF Ports Operation |
| LT5521 | 10MHz to 3700MHz High Linearity Upconverting Mixer | 24.2dBm IIP3 at 1.95GHz, NF = 12.5dB, 3.15V to 5.25V Supply, Single-Ended LO Port Operation |
| LT5522 | 400MHz to 2.7GHz High Signal Level Downconverting Mixer | 4.5V to 5.25V Supply, 25dBm IIP3 at 900MHz, NF = 12.5dB, 50Ω Single-Ended RF and LO Ports |
| LT5526 | High Linearity, Low Power Downconverting Mixer | 3V to 5.3V Supply, 16.5dBm IIP3, 100kHz to 2GHz RF, NF = 11dB, I _{CC} = 28mA, -65dBm LO-RF Leakage |
| LT5527 | 400MHz to 3.7GHz High Signal Level Downconverting Mixer | IIP3 = 23.5dBm and NF = 12.5dBm at 1900MHz, 4.5V to 5.25V Supply, I _{CC} = 78mA, Conversion Gain = 2dB |
| LT5528 | 1.5GHz to 2.4GHz High Linearity Direct Quadrature Modulator | 21.8dBm OIP3 at 2GHz, -159.3dBm/Hz Noise Floor, 50Ω, 0.5V _{DC} Baseband Interface, 4-Channel W-CDMA ACPR = -66dBc at 2.14GHz |
| LT5557 | 400MHz to 3.8GHz 3.3V Downconverting Mixer | IIP3 = 23.5dBm at 3.6GHz, NF = 15.4dB, Conversion Gain = 1.7dB, 3.3V Supply at 82mA, Single-Ended RF and LO Inputs |
| LT5558 | 600MHz to 1100MHz High Linearity Direct Quadrature Modulator | 22.4dBm OIP3 at 900MHz, -158dBm/Hz Noise Floor, 3kΩ, 2.1V _{DC} Baseband Interface, 3-Ch CDMA2000 ACPR = -70.4dBc at 900MHz |
| LT5560 | Ultra-Low Power Active Mixer | 10mA Supply Current, 10dBm IIP3, 10dB NF, Usable as Up- or Down-Converter. |
| LT5568 | 700MHz to 1050MHz High Linearity Direct Quadrature Modulator | 22.9dBm OIP3 at 850MHz, -160.3dBm/Hz Noise Floor, 50Ω, 0.5V _{DC} Baseband Interface, 3-Ch CDMA2000 ACPR = -71.4dBc at 850MHz |
| LT5572 | 1.5GHz to 2.5GHz High Linearity Direct Quadrature Modulator | 21.6dBm OIP3 at 2GHz, -158.6dBm/Hz Noise Floor, High-Ohmic 0.5V _{DC} Baseband Interface, 4-Ch W-CDMA ACPR = -67.7dBc at 2.14GHz |
| LT5575 | 700MHz to 2.7GHz Direct Conversion I/Q Demodulator | Integrated Baluns, 28dBm IIP3, 13dBm P1dB, 0.03dB I/Q Amplitude Match, 0.4° Phase Match |
| LT5579 | 1.5GHz to 3.8GHz High Linearity Upconverting Mixer | 27.3dBm OIP3 at 2.14GHz, NF = 9.9dB, 3.3V Supply, Single-Ended LO and RF Ports |
| RF Power Detectors | | |
| LTC®5505 | RF Power Detectors with >40dB Dynamic Range | 300MHz to 3GHz, Temperature Compensated, 2.7V to 6V Supply |
| LTC5507 | 100kHz to 1000MHz RF Power Detector | 100kHz to 1GHz, Temperature Compensated, 2.7V to 6V Supply |
| LTC5508 | 300MHz to 7GHz RF Power Detector | 44dB Dynamic Range, Temperature Compensated, SC70 Package |
| LTC5509 | 300MHz to 3GHz RF Power Detector | 36dB Dynamic Range, Low Power Consumption, SC70 Package |
| LTC5530 | 300MHz to 7GHz Precision RF Power Detector | Precision V _{OUT} Offset Control, Shutdown, Adjustable Gain |
| LTC5531 | 300MHz to 7GHz Precision RF Power Detector | Precision V _{OUT} Offset Control, Shutdown, Adjustable Offset |
| LTC5532 | 300MHz to 7GHz Precision RF Power Detector | Precision V _{OUT} Offset Control, Adjustable Gain and Offset |
| LT5534 | 50MHz to 3GHz Log RF Power Detector with 60dB Dynamic Range | ±1dB Output Variation over Temperature, 38ns Response Time, Log Linear Response |
| LTC5536 | Precision 600MHz to 7GHz RF Power Detector with Fast Comparator Output | 25ns Response Time, Comparator Reference Input, Latch Enable Input, -26dBm to +12dBm Input Range |
| LT5537 | Wide Dynamic Range Log RF/IF Detector | Low Frequency to 1GHz, 83dB Log Linear Dynamic Range |
| LT5570 | 2.7GHz Mean-Squared Detector | ±0.5dB Accuracy Over Temperature and >50dB Dynamic Range, Fast 500ns Rise Time |
| LT5581 | 6GHz Low Power RMS Detector | 40dB Dynamic Range, ±1dB Accuracy Over Temperature, 1.5mA Supply Current |