

# 18V, 10A Synchronous Step-Down Silent Switcher 2

## FEATURES

- **Silent Switcher®2 Architecture**
  - **Ultralow EMI Emissions On Any PCB**
  - **Eliminates PCB Layout Sensitivity**
  - **Internal Bypass Capacitors Reduce Radiated EMI**
  - **Optional Spread Spectrum Modulation**
- **High Efficiency at High Frequency**
  - **Up to 96% Efficiency at 1MHz, 12V<sub>IN</sub> to 3.3V<sub>OUT</sub>**
  - **Up to 95% Efficiency at 2MHz, 12V<sub>IN</sub> to 3.3V<sub>OUT</sub>**
- **Wide Input Voltage Range: 2.8V to 18V**
- **10A Output Current**
- **External Compensation: Fast Transient Response and Current Sharing**
- **Low Quiescent Current Burst Mode® Operation**
  - 240µA I<sub>Q</sub> Regulating 12V<sub>IN</sub> to 1.2V<sub>OUT</sub>
  - Output Ripple < 10mV<sub>P-P</sub>
- **Fast Minimum Switch On-Time: 25ns**
- **Low Dropout Under All Conditions: 50mV at 1A**
- **Forced Continuous Mode**
- **Adjustable and Synchronizable: 200kHz to 3MHz**
- **Output Soft-Start and Power Good**
- **Small 24-Lead 4mm × 4mm LQFN Package**

## APPLICATIONS

- Server Power Applications
- General Purpose Step-Down

All registered trademarks and trademarks are the property of their respective owners. Protected by U.S. patents 8823345.

## DESCRIPTION

The **LT®8642S** synchronous step-down regulator features second generation Silent Switcher architecture designed to minimize EMI emissions while delivering high efficiency at high switching frequencies. This includes the integration of bypass capacitors to optimize all the fast current loops inside and make it easy to achieve advertised EMI performance by eliminating layout sensitivity. This performance makes the LT8642S ideal for noise sensitive applications and environments.

The fast, clean, low-overshoot switching edges enable high efficiency operation even at high switching frequencies, leading to a small overall solution size. Peak current mode control with a 25ns minimum on-time allows high step down ratios even at high switching frequencies. External compensation via the V<sub>C</sub> pin allows for fast transient response at high switching frequencies. The V<sub>C</sub> pin also enables current sharing and a CLKOUT pin enables synchronizing other regulators to the LT8642S.

Burst Mode operation enables low standby current consumption, forced continuous mode can control frequency harmonics across the entire output load range, or spread spectrum operation can further reduce EMI emissions. Soft-start and tracking functionality is accessed via the SS pin, and an accurate input voltage UVLO threshold can be set using the EN/UV pin.

## TYPICAL APPLICATION

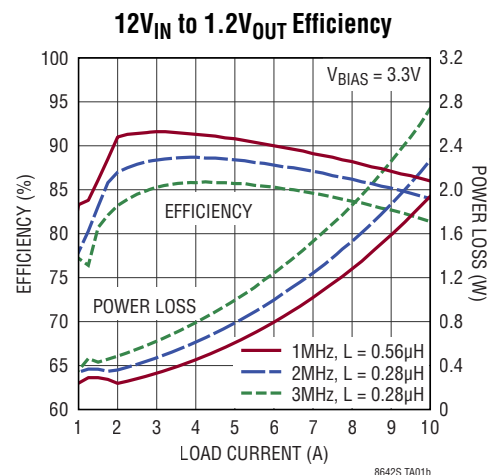
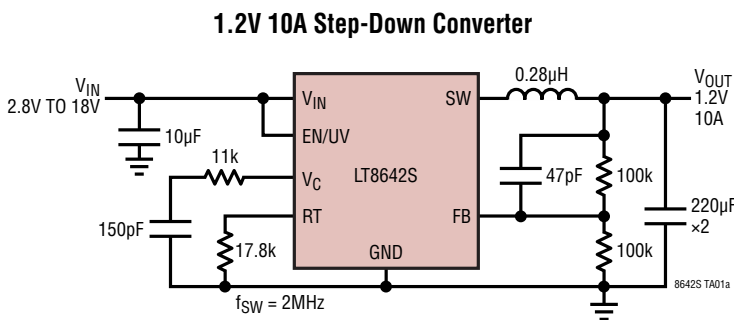

# LT8642S

## ABSOLUTE MAXIMUM RATINGS

(Note 1)

$V_{IN}$ , EN/UV, PG, BIAS .....	18V
FB, SS .....	4V
SYNC/MODE Voltage .....	6V
Operating Junction Temperature Range (Note 2)	
LT8642SE .....	-40°C to 125°C
LT8642SI .....	-40°C to 125°C
Storage Temperature Range .....	-65°C to 150°C
Maximum Reflow (Package Body) Temperature ...	260°C

## PIN CONFIGURATION

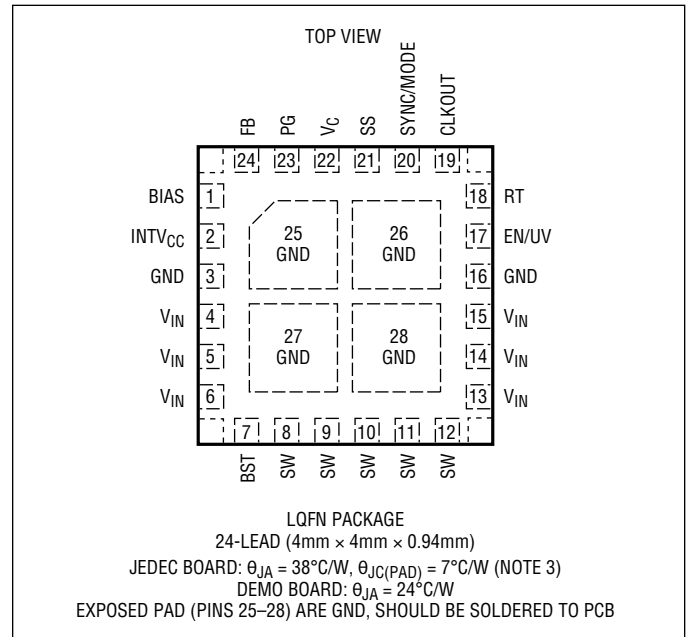

## ORDER INFORMATION <http://www.linear.com/product/LT8642S#orderinfo>

PART NUMBER	PART MARKING*	FINISH CODE	PAD FINISH	PACKAGE** TYPE	MSL RATING	TEMPERATURE RANGE
LT8642SEV#PBF	8642S	e4	Au (RoHS)	LQFN (Laminate Package with QFN Footprint)	3	-40°C to 125°C
LT8642SIV#PBF						-40°C to 125°C

- Consult Marketing for parts specified with wider operating temperature ranges. \*Device temperature grade is identified by a label on the shipping container.
- Pad finish code is per IPC/JEDEC J-STD-609.

- Terminal Finish Part Marking: [www.linear.com/leadfree](http://www.linear.com/leadfree)
- Recommended PCB Assembly and Manufacturing Procedures: [www.linear.com/umodule/pcbassembly](http://www.linear.com/umodule/pcbassembly)
- Package and Tray Drawings: [www.linear.com/packaging](http://www.linear.com/packaging)

Parts ending with PBF are RoHS and WEEE compliant. \*\*The LT8642S package has the same dimensions as a standard 4mm × 4mm QFN package.

## ELECTRICAL CHARACTERISTICS

The ● denotes the specifications which apply over the full operating temperature range, otherwise specifications are at  $T_A = 25^{\circ}\text{C}$ .

PARAMETER	CONDITIONS	MIN	TYP	MAX	UNITS
Minimum Input Voltage	●		2.5	2.8	V
$V_{IN}$ Quiescent Current in Shutdown	$V_{EN/UV} = 0\text{V}$ , $V_{IN} = 12\text{V}$		0.75	3	$\mu\text{A}$
$V_{IN}$ Quiescent Current in Sleep	$V_{EN/UV} = 2\text{V}$ , $V_{FB} > 0.597\text{V}$ , $V_{SYNC} = 0\text{V}$ , $V_{BIAS} = 0\text{V}$ , $V_{IN} = 12\text{V}$	●	230	290	$\mu\text{A}$
Feedback Reference Voltage	$V_{IN} = 6\text{V}$ , $V_C = 1.25\text{V}$	●	0.594	0.597	V
	$V_{IN} = 6\text{V}$ , $V_C = 1.25\text{V}$	●	0.586	0.597	V
Feedback Voltage Line Regulation	$V_{IN} = 4.0\text{V}$ to 18V	●	0.004	0.02	%/V
Feedback Pin Input Current	$V_{FB} = 0.6\text{V}$		-20	20	nA
Error Amplifier Transconductance	$V_C = 1.25\text{V}$		1.4	1.7	mS
Error Amp Gain			340		

Rev 0

**ELECTRICAL CHARACTERISTICS** The ● denotes the specifications which apply over the full operating temperature range, otherwise specifications are at T<sub>A</sub> = 25°C.

PARAMETER	CONDITIONS		MIN	TYP	MAX	UNITS
V <sub>C</sub> Source Current	V <sub>FB</sub> = 0.4V, V <sub>C</sub> = 1.25V			360		μA
V <sub>C</sub> Sink Current	V <sub>FB</sub> = 0.8V, V <sub>C</sub> = 1.25V			360		μA
V <sub>C</sub> Pin to Switch Current Gain				8.5		A/V
V <sub>C</sub> Clamp Voltage				2.6		V
BIAS Pin Current Consumption	V <sub>BIAS</sub> = 3.3V, f <sub>SW</sub> = 2MHz			20		mA
Minimum On-Time	I <sub>LOAD</sub> = 3A, SYNC = 2V	●		20	35	ns
Minimum Off-Time				80	110	ns
Oscillator Frequency	R <sub>T</sub> = 221k	●	175	210	245	kHz
	R <sub>T</sub> = 60.4k	●	655	700	745	
	R <sub>T</sub> = 18.2k	●	1.875	1.95	2.025	
Top Power NMOS On-Resistance				17.5		mΩ
Top Power NMOS Current Limit		●	14.5	18	21.5	A
Bottom Power NMOS On-Resistance	V <sub>INTVCC</sub> = 3.4V			8		mΩ
Bottom Power NMOS Current Limit	V <sub>INTVCC</sub> = 3.4V		10.5	13.5	16	A
SW Leakage Current	V <sub>IN</sub> = 18V, V <sub>SW</sub> = 0V, 18V		-15		15	μA
EN/UV Pin Threshold	EN/UV Rising	●	0.93	0.99	1.05	V
EN/UV Pin Hysteresis				40		mV
EN/UV Pin Current	V <sub>EN/UV</sub> = 2V		-20		20	nA
PG Upper Threshold Offset from V <sub>FB</sub>	V <sub>FB</sub> Rising	●	5	8	11	%
PG Lower Threshold Offset from V <sub>FB</sub>	V <sub>FB</sub> Falling	●	-5.5	-8.5	-11.5	%
PG Hysteresis				0.4		%
PG Leakage	V <sub>PG</sub> = 3.3V		-40		40	nA
PG Pull-Down Resistance	V <sub>PG</sub> = 0.1V	●		650	2000	Ω
SYNC/MODE Threshold	SYNC/MODE DC and Clock Low Level Voltage	●	0.7			V
	SYNC/MODE Clock High Level Voltage	●			1.4	V
	SYNC/MODE DC High Level Voltage	●	2.2		2.9	V
Spread Spectrum Modulation Frequency Range	R <sub>T</sub> = 60.4k, V <sub>SYNC</sub> = 3.3V			22		%
Spread Spectrum Modulation Frequency	V <sub>SYNC</sub> = 3.3V			3		kHz
SS Source Current		●	1.2	1.9	2.6	μA
SS Pull-Down Resistance	Fault Condition, SS = 0.1V			220		Ω

**Note 1:** Stresses beyond those listed under Absolute Maximum Ratings may cause permanent damage to the device. Exposure to any Absolute Maximum Rating condition for extended periods may affect device reliability and lifetime.

**Note 2:** The LT8642SE is guaranteed to meet performance specifications from 0°C to 125°C junction temperature. Specifications over the -40°C to 125°C operating junction temperature range are assured by design, characterization, and correlation with statistical process controls. The LT8642SI is guaranteed over the full -40°C to 125°C operating junction temperature range. The junction temperature (T<sub>J</sub>, in °C) is calculated from the ambient temperature (T<sub>A</sub> in °C) and power dissipation (PD, in Watts) according to the formula:

$$T_J = T_A + (PD \cdot \theta_{JA})$$

where  $\theta_{JA}$  (in °C/W) is the package thermal impedance.

**Note 3:**  $\theta$  values determined per JEDEC 51-7, 51-12. See the Applications Information section for information on improving the thermal resistance and for actual temperature measurements of a demo board in typical operating conditions.

**Note 4:** This IC includes overtemperature protection that is intended to protect the device during overload conditions. Junction temperature will exceed 150°C when overtemperature protection is active. Continuous operation above the specified maximum operating junction temperature will reduce lifetime.

TYPICAL PERFORMANCE CHARACTERISTICS

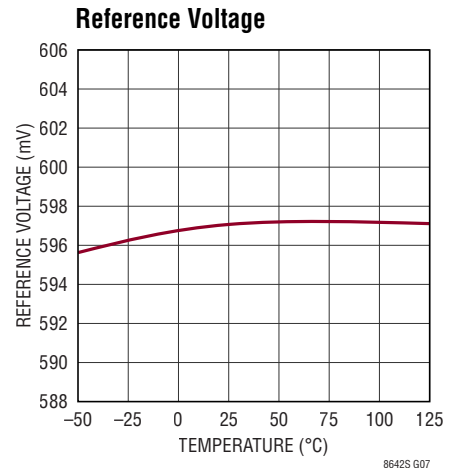
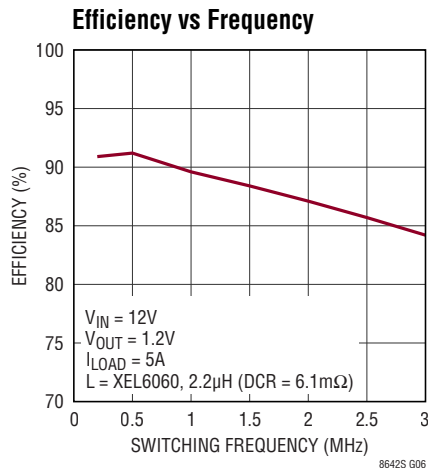
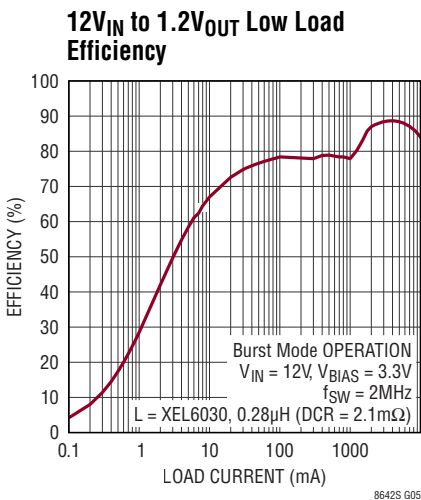
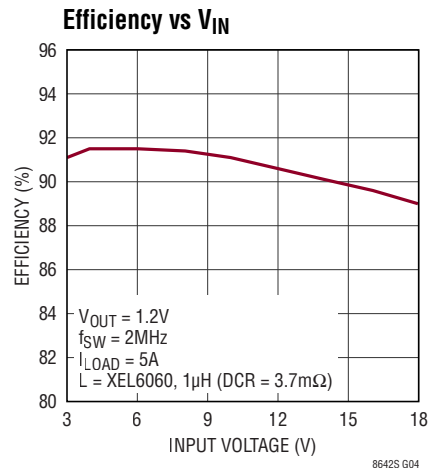
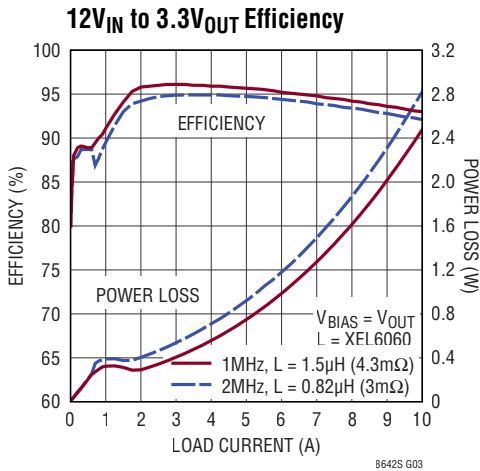
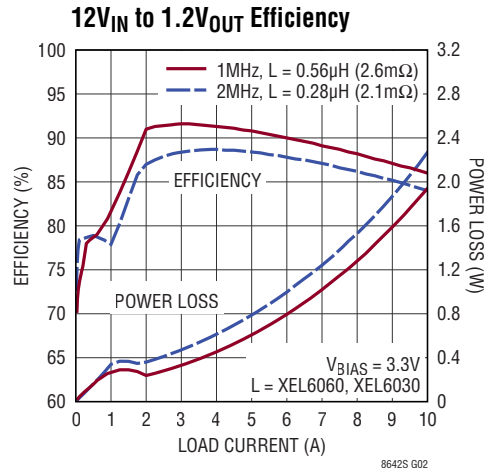
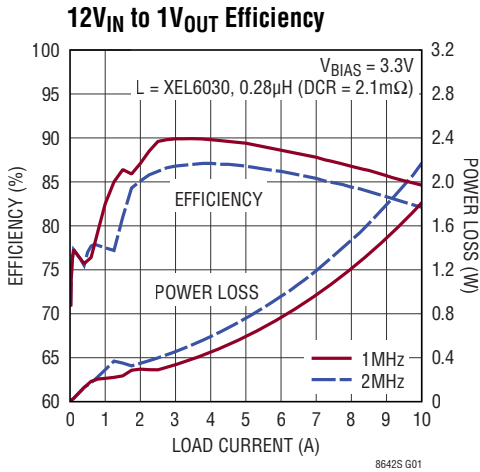

# TYPICAL PERFORMANCE CHARACTERISTICS

**EN Pin Thresholds**

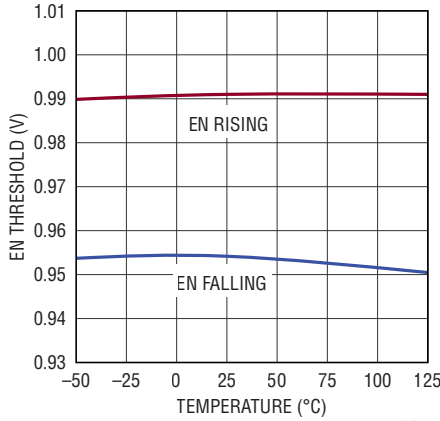

**Load Regulation**

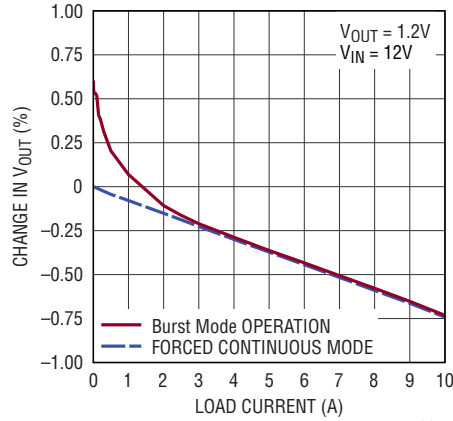

**Line Regulation**

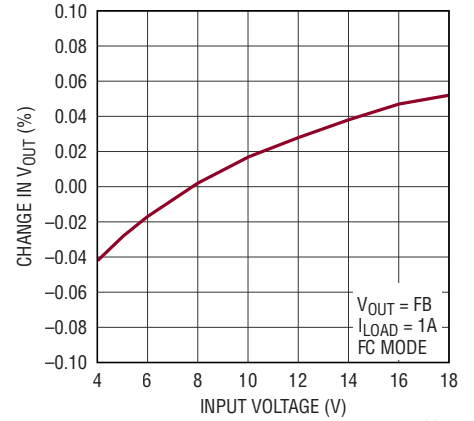

**No-Load Supply Current**

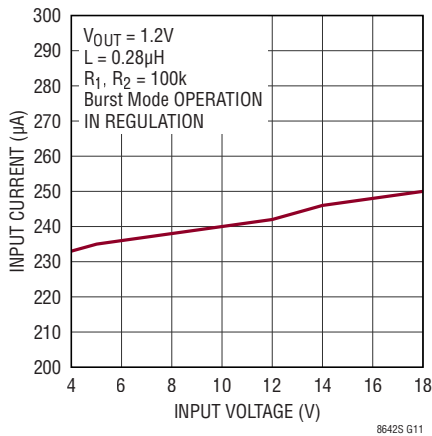

**Top FET Current Limit vs Duty Cycle**

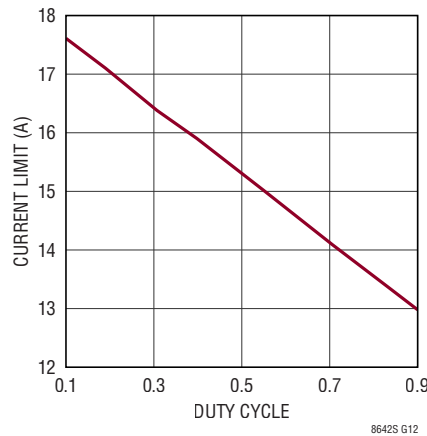

**Top FET Current Limit**

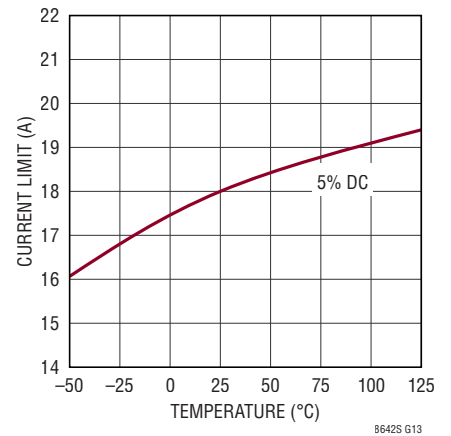

**Switch  $R_{DS(ON)}$  vs Temperature**

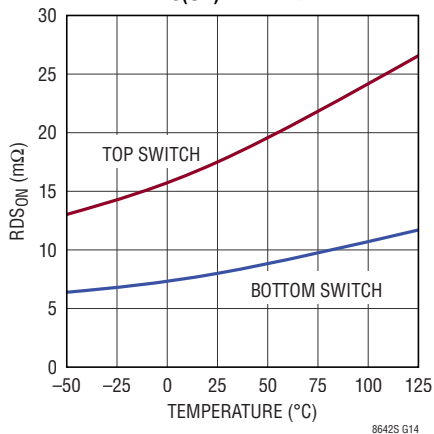

**Dropout Voltage**

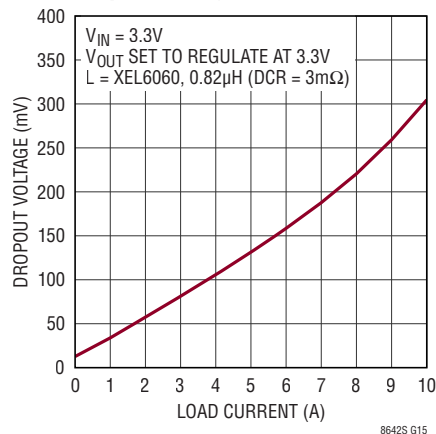

## TYPICAL PERFORMANCE CHARACTERISTICS

### Minimum On-Time

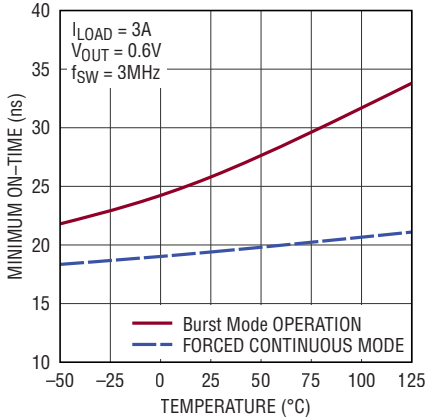

8642S G16

### Switching Frequency

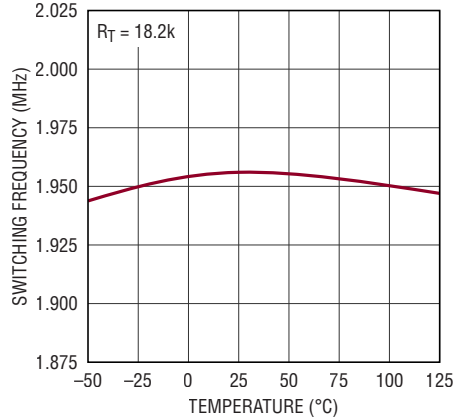

8642S G17

### Burst Frequency

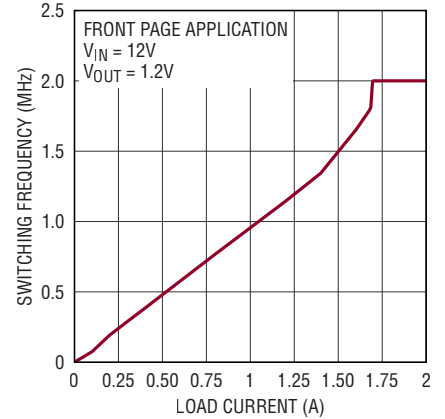

8642S G18

### Soft-Start Tracking

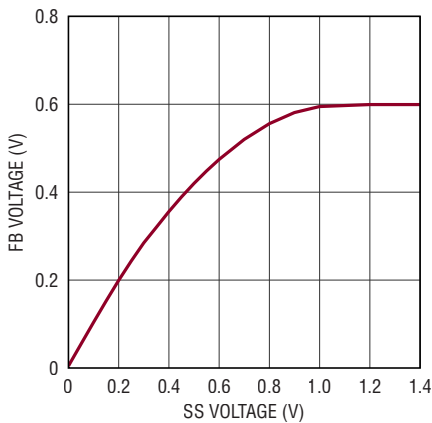

8642S G19

### Soft-Start Current

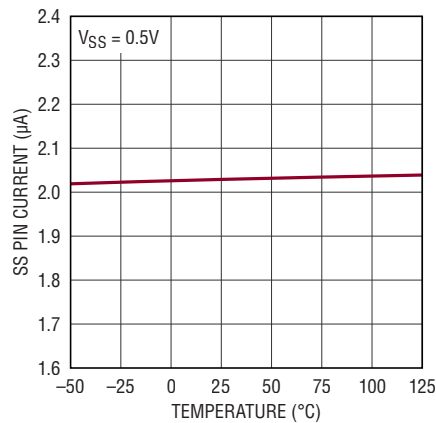

8642S G20

### Error Amp Output Current

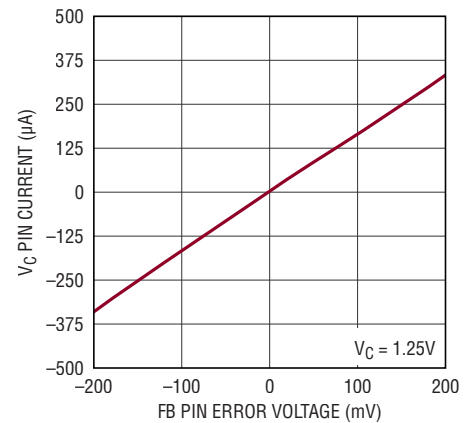

8642S G21

### PG High Thresholds

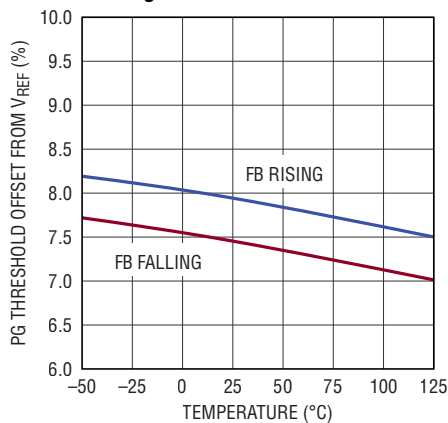

8642S G22

### PG Low Thresholds

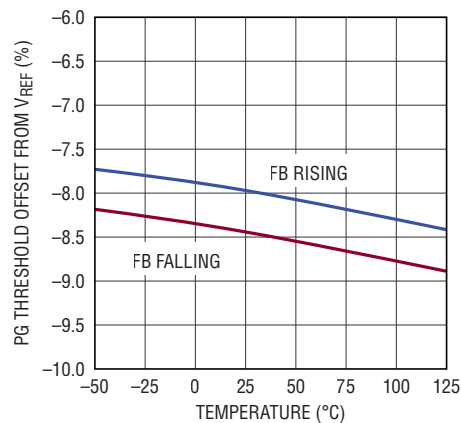

8642S G23

# TYPICAL PERFORMANCE CHARACTERISTICS

**RT Programmed Switching Frequency**

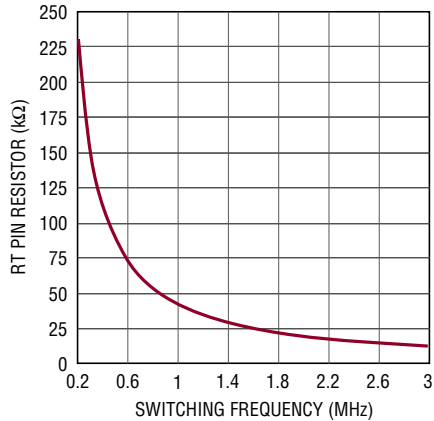

8642S G24

**Minimum Input Voltage**

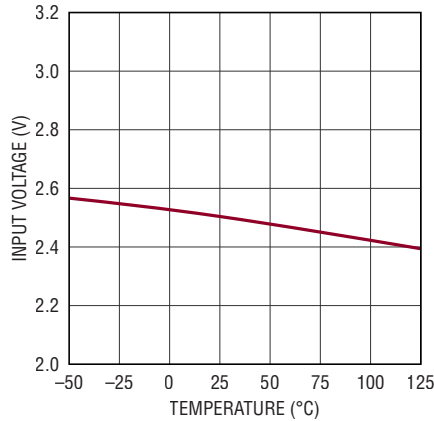

8642S G25

**Bias Pin Current vs  $V_{IN}$**

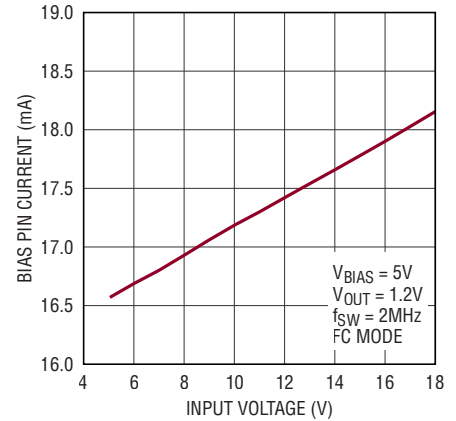

8642S G26

**Bias Pin Current vs Frequency**

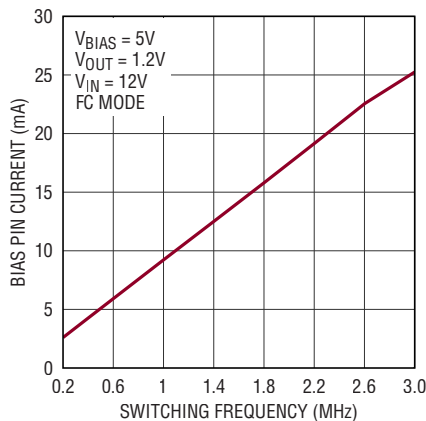

8642S G27

**Case Temperature Rise**

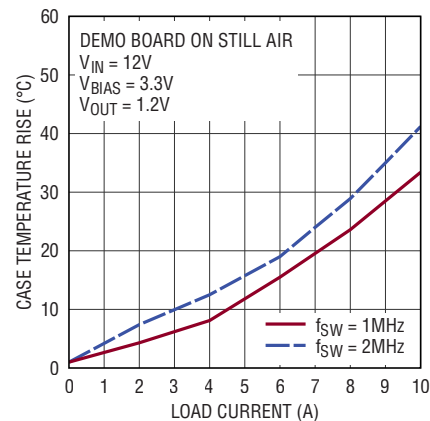

8642S G28

**Switching Rising Edge**

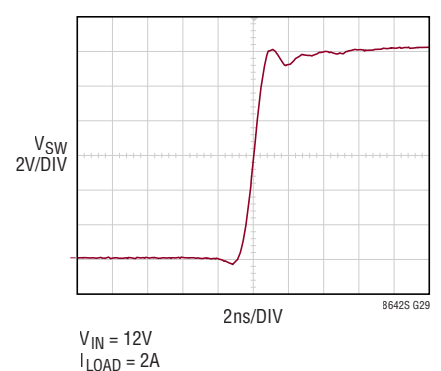

8642S G29

**CLKOUT Waveforms**

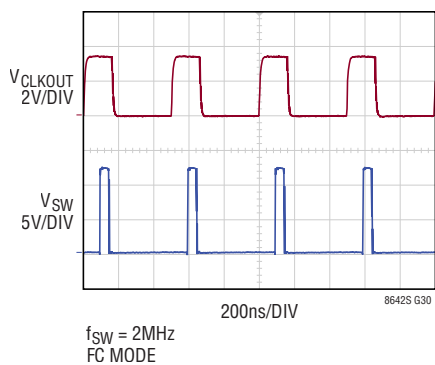

8642S G30

**Switching Waveforms, Full Frequency Continuous Operation**

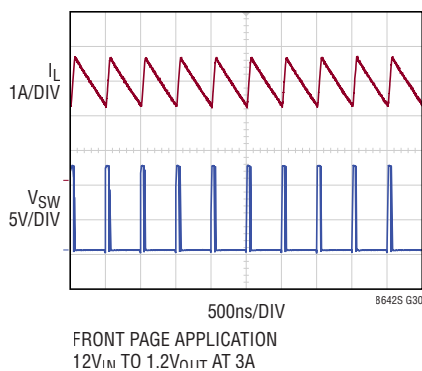

8642S G30

**Switching Waveforms, Burst Mode Operation**

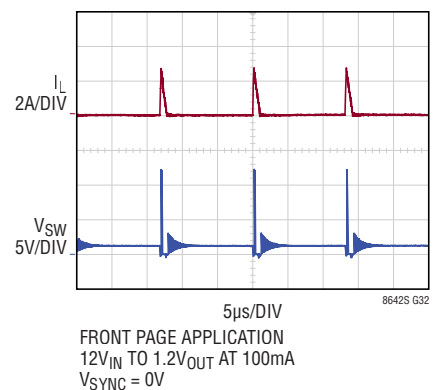

8642S G32

## TYPICAL PERFORMANCE CHARACTERISTICS

**Transient Response; Load Current Stepped from 2A to 7A**

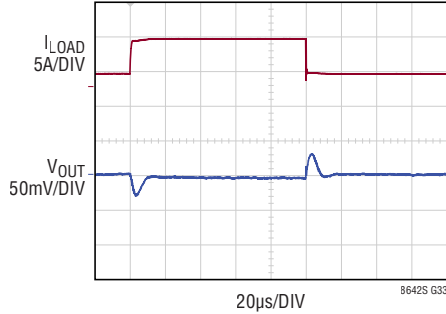

FRONT PAGE APPLICATION  
 2A TO 7A TRANSIENT  
 $V_{IN} = 12V$ ,  $V_{OUT} = 1.2V$ ,  $f_{SW} = 2MHz$   
 $C_C = 150pF$ ,  $R_C = 11k$   
 $C_{OUT} = 2 \times 220\mu F$ ,  $C_{LEAD} = 47pF$

**Transient Response; Load Current Stepped from 100mA to 5.1A**

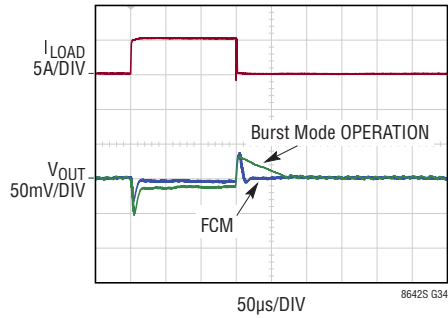

FRONT PAGE APPLICATION  
 100mA TO 5.1A TRANSIENT  
 $V_{IN} = 12V$ ,  $V_{OUT} = 1.2V$ ,  $f_{SW} = 2MHz$   
 $C_C = 150pF$ ,  $R_C = 11k$   
 $C_{OUT} = 2 \times 220\mu F$ ,  $C_{LEAD} = 47pF$

**Start-Up Dropout Performance**

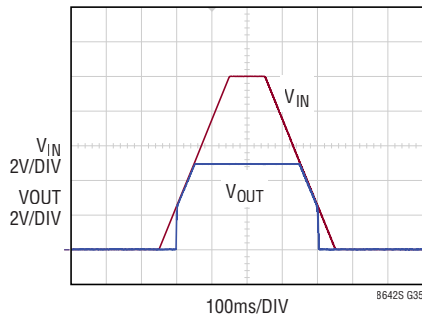

1Ω LOAD  
 (5A IN REGULATION)

**Start-Up Dropout Performance**

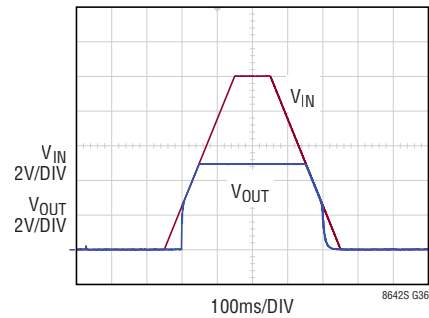

20Ω LOAD  
 (250mA IN REGULATION)



# TYPICAL PERFORMANCE CHARACTERISTICS

## Conducted EMI Performance

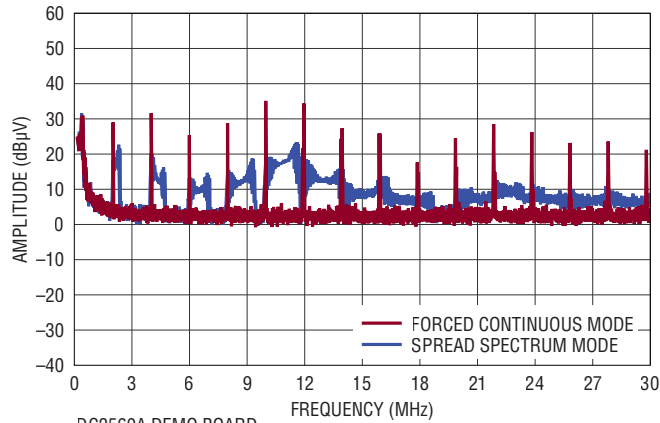

DC2560A DEMO BOARD  
(WITH EMI FILTER INSTALLED)  
12V INPUT TO 1.2V OUTPUT AT 10A,  $f_{SW} = 2\text{MHz}$

8642S G37

## Radiated EMI Performance (CISPR32 Radiated Emission Test with Class B Limits)

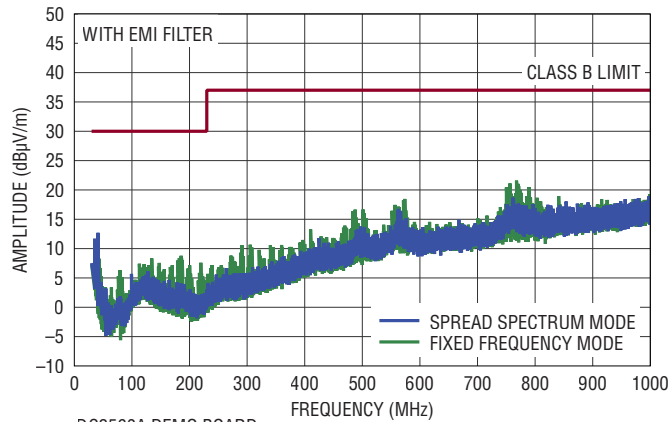

DC2560A DEMO BOARD  
12V INPUT TO 1.2V OUTPUT AT 10A,  $f_{SW} = 2\text{MHz}$

8642S G38

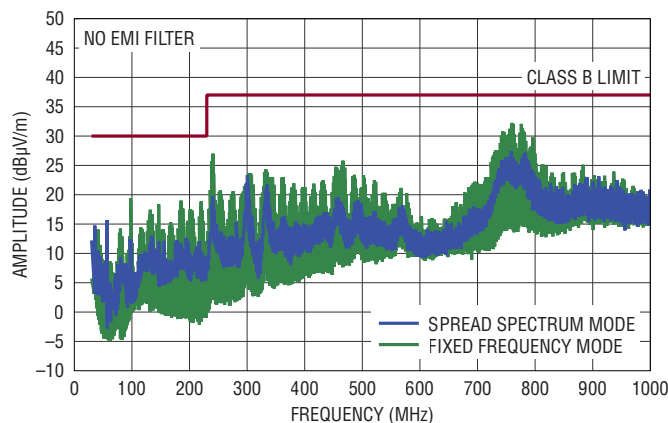

DC2560A DEMO BOARD  
12V INPUT TO 1.2V OUTPUT AT 10A,  $f_{SW} = 2\text{MHz}$

8642S G39

## PIN FUNCTIONS

**BIAS (Pin 1):** The internal regulator will draw current from BIAS instead of  $V_{IN}$  when BIAS is tied to a voltage higher than 3.1V. For output voltages of 3.3V and above this pin should be tied to  $V_{OUT}$ . If this pin is tied to a supply other than  $V_{OUT}$  use a  $1\mu\text{F}$  local bypass capacitor on this pin. If no supply is available, tie to GND. However, especially for high input or high frequency applications, BIAS should be tied to output or external supply of 3.3V or above.

**INTV<sub>CC</sub> (Pin 2):** Internal 3.4V Regulator Bypass Pin. The internal power drivers and control circuits are powered from this voltage. Do not load the INTV<sub>CC</sub> pin with external circuitry. INTV<sub>CC</sub> current will be supplied from BIAS if  $\text{BIAS} > 3.1\text{V}$ , otherwise current will be drawn from  $V_{IN}$ . Voltage on INTV<sub>CC</sub> will vary between 2.8V and 3.4V when BIAS is between 3.0V and 3.6V. This pin should be floated.

**GND (Pins 3, 16, Exposed Pad Pins 25–28):** Ground. Place the negative terminal of the input capacitor as close to the GND pins as possible. The exposed pads should be soldered to the PCB for good thermal performance. If necessary due to manufacturing limitations Pins 25 to 28 may be left disconnected, however thermal performance will be degraded.

**$V_{IN}$  (Pins 4, 5, 6, 13, 14, 15):** The  $V_{IN}$  pins supply current to the LT8642S internal circuitry and to the internal topside power switch. These pins must be tied together and be locally bypassed with a capacitor of  $4.7\mu\text{F}$  or more. Be sure to place the positive terminal of the input capacitor as close as possible to the  $V_{IN}$  pins, and the negative capacitor terminal as close as possible to the GND pins.

**BST (Pin 7):** This pin is used to provide a drive voltage, higher than the input voltage, to the topside power switch. This pin should be floated.

**SW (Pins 8–12):** The SW pins are the outputs of the internal power switches. Tie these pins together and connect them to the inductor. This node should be kept small on the PCB for good performance and low EMI.

**EN/UV (Pin 17):** The LT8642S is shut down when this pin is low and active when this pin is high. The hysteresis threshold voltage is 0.99V going up and 0.95V going down. Tie to  $V_{IN}$  if the shutdown feature is not used. An

external resistor divider from  $V_{IN}$  can be used to program a  $V_{IN}$  threshold below which the LT8642S will shut down.

**RT (Pin 18):** A resistor is tied between RT and ground to set the switching frequency.

**CLKOUT (Pin 19):** In forced continuous mode, spread spectrum, and synchronization modes, the CLKOUT pin will provide a  $\sim 200\text{ns}$  wide pulse at the switch frequency. The low and high levels of the CLKOUT pin are ground and INTV<sub>CC</sub> respectively, and the drive strength of the CLKOUT pin is several hundred ohms. In Burst Mode operation, the CLKOUT pin will be low. Float this pin if the CLKOUT function is not used.

**SYNC/MODE (Pin 20):** For the LT8642S, this pin programs four different operating modes: (1) Burst Mode operation. Tie this pin to ground for Burst Mode operation at low output loads—this will result in low quiescent current. (2) Forced Continuous mode (FCM). This mode offers fast transient response and full frequency operation over a wide load range. Float this pin for FCM. When floating, pin leakage currents should be  $< 1\mu\text{A}$ . See Block Diagram for internal pull-up and pull-down resistance. (3) Spread spectrum mode. Tie this pin high to INTV<sub>CC</sub> (or  $> 3\text{V}$ ) for forced continuous mode with spread-spectrum modulation. (4) Synchronization mode. Drive this pin with a clock source to synchronize to an external frequency. During synchronization the part will operate in forced continuous mode.

**SS (Pin 21):** Output Tracking and Soft-Start Pin. This pin allows user control of output voltage ramp rate during start-up. A SS voltage below 1V forces the LT8642S to regulate the FB pin to a function of the SS pin voltage. See plot in the Typical Performance Characteristics section. When SS is above 1V, the tracking function is disabled and the internal reference resumes control of the error amplifier. An internal  $1.9\mu\text{A}$  pull-up current from INTV<sub>CC</sub> on this pin allows a capacitor to program output voltage slew rate. This pin is pulled to ground with an internal  $200\Omega$  MOSFET during shutdown and fault conditions; use a series resistor if driving from a low impedance output. This pin may be left floating if the soft-start feature is not being used.

## PIN FUNCTIONS

**V<sub>C</sub> (Pin 22):** The V<sub>C</sub> pin is the output of the internal error amplifier. The voltage on this pin controls the peak switch current. Tie an RC network from this pin to ground to compensate the control loop.

**PG (Pin 23):** The PG pin is the open-drain output of an internal comparator. PG remains low until the FB pin is within ±8% of the final regulation voltage, and there are no fault conditions. PG is also pulled low when EN/UV is below 1V, INTV<sub>CC</sub> has fallen too low, V<sub>IN</sub> is too low, or thermal shutdown. PG is valid when V<sub>IN</sub> is above 2.8V.

**FB (Pin 24):** The LT8642S regulates the FB pin to 0.597V. Connect the feedback resistor divider tap to this pin. Also, connect a phase lead capacitor between FB and V<sub>OUT</sub>. Typically, this capacitor is 4.7pF to 47pF.

**Corner Pins:** These pins are for mechanical support only and can be tied anywhere on the PCB, typically ground.

## BLOCK DIAGRAM

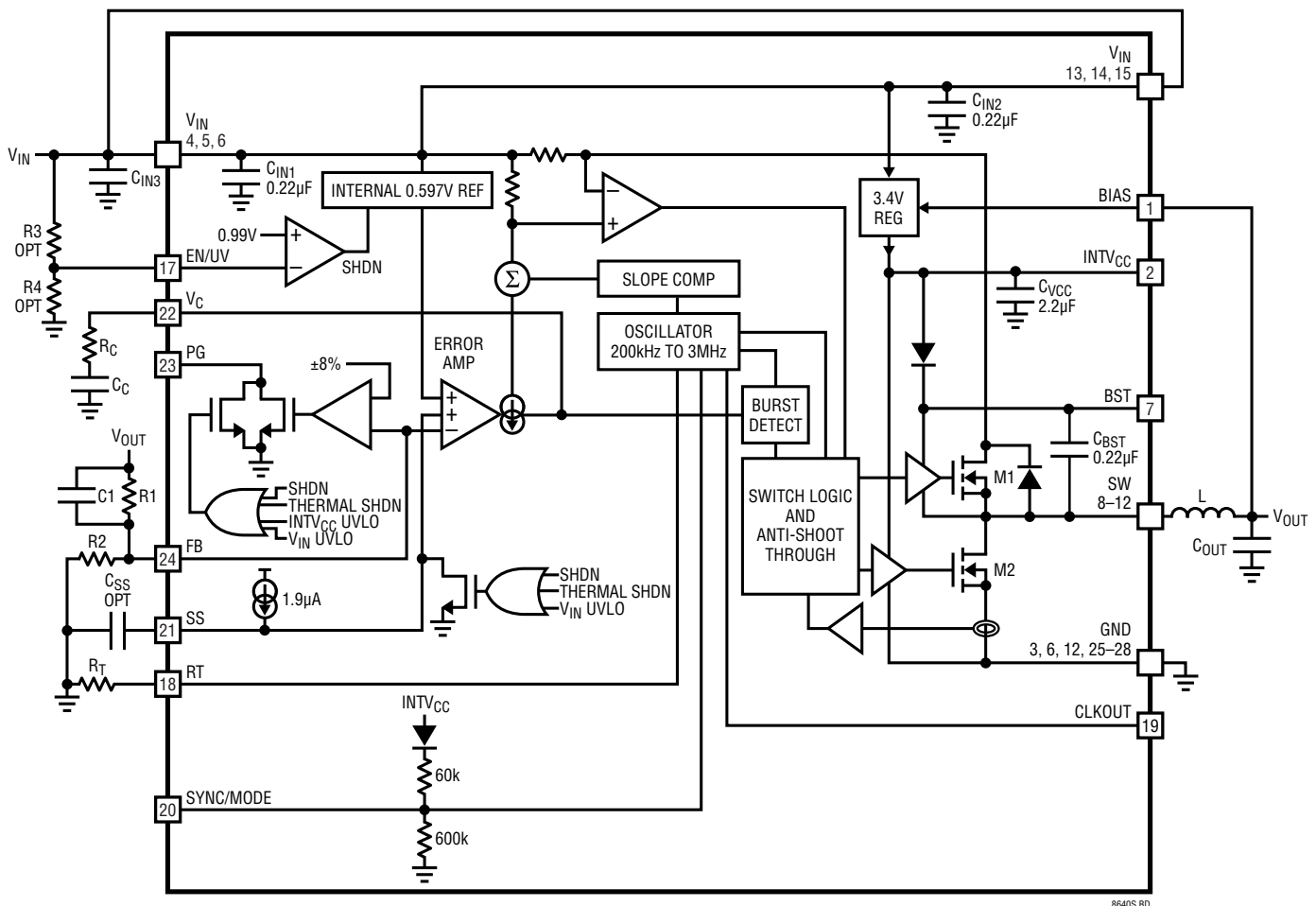

## OPERATION

The LT8642S is a monolithic, constant frequency, current mode step-down DC/DC converter. An oscillator, with frequency set using a resistor on the RT pin, turns on the internal top power switch at the beginning of each clock cycle. Current in the inductor then increases until the top switch current comparator trips and turns off the top power switch. The peak inductor current at which the top switch turns off is controlled by the voltage on the  $V_C$  pin. The error amplifier servos the  $V_C$  node by comparing the voltage on the  $V_{FB}$  pin with an internal 0.597V reference. When the load current increases it causes a reduction in the feedback voltage relative to the reference leading the error amplifier to raise the  $V_C$  voltage until the average inductor current matches the new load current. When the top power switch turns off, the synchronous power switch turns on until the next clock cycle begins or inductor current falls to zero. If overload conditions result in more than 13.5A flowing through the bottom switch, the next clock cycle will be delayed until switch current returns to a safe level.

The “S” in LT8642S refers to the second generation silent switcher technology. This technology allows fast switching edges for high efficiency at high switching frequencies, while simultaneously achieving good EMI performance. This includes the integration of ceramic capacitors into the package for  $V_{IN}$ , BST, and INTV<sub>CC</sub> (see Block Diagram). These caps keep all the fast AC current loops small, which improves EMI performance.

If the EN/UV pin is low, the LT8642S is shut down and draws 1 $\mu$ A from the input. When the EN/UV pin is above 0.99V, the switching regulator will become active.

To optimize efficiency at light loads, the LT8642S operates in Burst Mode operation in light load situations. Between bursts, all circuitry associated with controlling the output switch is shut down, reducing the input supply current to 230 $\mu$ A. In a typical application, 240 $\mu$ A will be consumed from the input supply when regulating with no load. The SYNC/MODE pin is tied low to use Burst Mode operation and can be floated to use forced continuous mode (FCM). If a clock is applied to the SYNC/MODE pin, the part will synchronize to an external clock frequency and operate in FCM.

The LT8642S can operate in forced continuous mode (FCM) for fast transient response and full frequency operation over a wide load range. When in FCM the oscillator operates continuously and positive SW transitions are aligned to the clock. Negative inductor current is allowed. The LT8642S can sink current from the output and return this charge to the input in this mode, improving load step transient response.

To improve EMI, the LT8642S can operate in spread spectrum mode. This feature varies the clock with a triangular frequency modulation of +20%. For example, if the LT8642S's frequency is programmed to switch at 2MHz, spread spectrum mode will modulate the oscillator between 2MHz and 2.4MHz. The SYNC/MODE pin should be tied high to INTV<sub>CC</sub> (or >3V) to enable spread spectrum modulation with forced continuous mode.

To improve efficiency across all loads, supply current to internal circuitry can be sourced from the BIAS pin when biased at 3.3V or above. Else, the internal circuitry will draw current from  $V_{IN}$ . The BIAS pin should be connected to  $V_{OUT}$  if the LT8642S output is programmed at 3.3V or above.

The  $V_C$  pin allows the loop compensation of the switching regulator to be optimized based on the programmed switching frequency, allowing for a fast transient response. The  $V_C$  pin also enables current sharing and a CLKOUT pin enables synchronizing other regulators to the LT8642S.

Comparators monitoring the FB pin voltage will pull the PG pin low if the output voltage varies more than  $\pm 8\%$  (typical) from the set point, or if a fault condition is present.

The oscillator reduces the LT8642S's operating frequency when the voltage at the FB pin is low. This frequency foldback helps to control the inductor current when the output voltage is lower than the programmed value which occurs during start-up or overcurrent conditions. When a clock is applied to the SYNC/MODE pin, the SYNC/MODE pin is floated, or held DC high, the frequency foldback is disabled and the switching frequency will slow down only during overcurrent conditions.

## APPLICATIONS INFORMATION

### Low EMI PCB Layout

The LT8642S is specifically designed to minimize EMI emissions and also to maximize efficiency when switching at high frequencies. For optimal performance the LT8642S should use multiple  $V_{IN}$  bypass capacitors.

Two small  $<1\mu\text{F}$  capacitors can be placed as close as possible to the LT8642S, one capacitor on each side of the device ( $C_{OPT1}$ ,  $C_{OPT2}$ ). A third capacitor with a larger value,  $4.7\mu\text{F}$  or higher, should be placed near  $C_{OPT1}$  or  $C_{OPT2}$ .

See Figure 1 for a recommended PCB layout.

For more detail and PCB design files refer to the Demo Board guide for the LT8642S.

Note that large, switched currents flow in the LT8642S  $V_{IN}$  and GND pins and the input capacitors. The loops formed by the input capacitors should be as small as possible by placing the capacitors adjacent to the  $V_{IN}$  and GND pins. Capacitors with small case size such as 0402 or 0603 are optimal due to lowest parasitic inductance.

The input capacitors, along with the inductor and output capacitors, should be placed on the same side of the circuit board, and their connections should be made on that layer. Place a local, unbroken ground plane under the application circuit on the layer closest to the surface layer. The SW and BOOST nodes should be as small as possible. Finally, keep the FB and RT nodes small so that the ground traces will shield them from the SW and BOOST nodes.

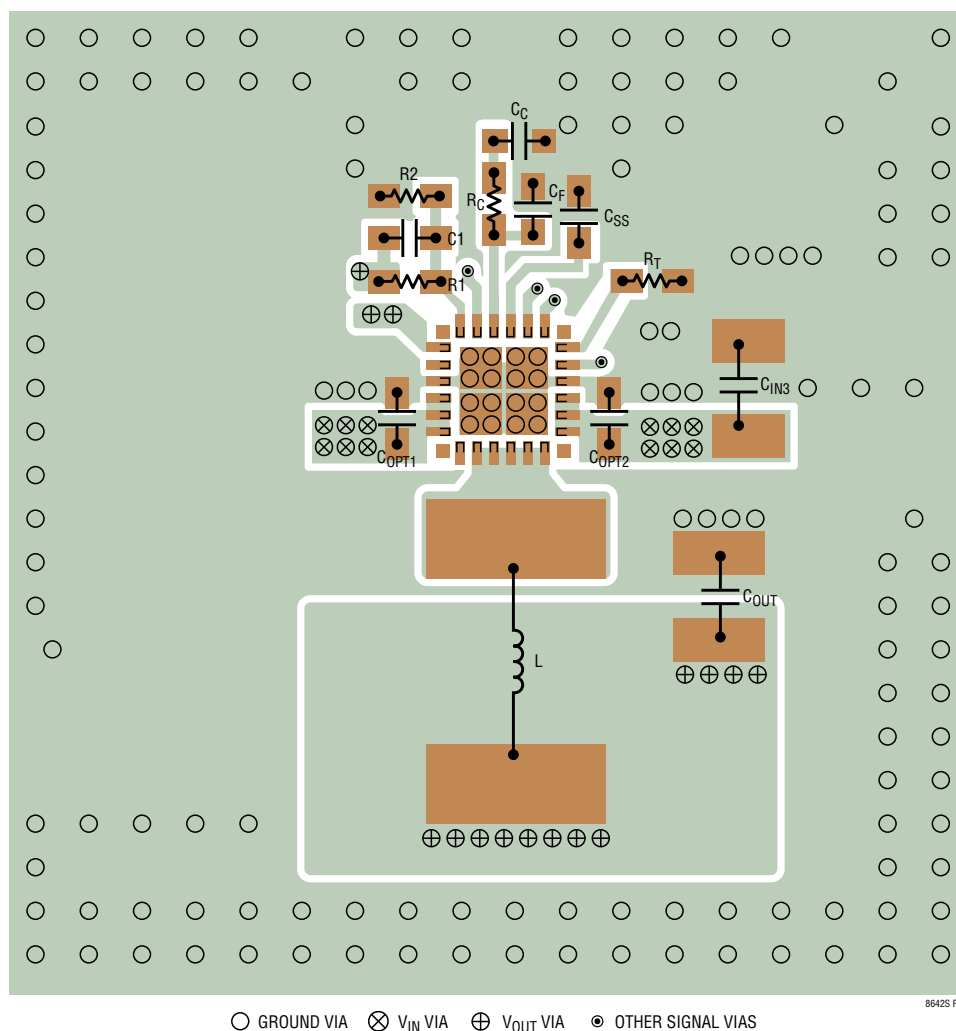

Figure 1. Recommended PCB Layout for the LT8642S

## APPLICATIONS INFORMATION

The exposed pads on the bottom of the package should be soldered to the PCB to reduce thermal resistance to ambient. To keep thermal resistance low, extend the ground plane from GND as much as possible, and add thermal vias to additional ground planes within the circuit board and on the bottom side.

### Burst Mode Operation

To enhance efficiency at light loads, the LT8642S operates in low ripple Burst Mode operation, which keeps the output capacitor charged to the desired output voltage while minimizing the input quiescent current and minimizing output voltage ripple. In Burst Mode operation the LT8642S delivers single small pulses of current to the output capacitor followed by sleep periods where the output power is supplied by the output capacitor. While in sleep mode the LT8642S consumes 230 $\mu$ A.

As the output load decreases, the frequency of single current pulses decreases (see Figure 2) and the percentage of time the LT8642S is in sleep mode increases, resulting in much higher light load efficiency than for typical converters. By maximizing the time between pulses, the converter quiescent current approaches 240 $\mu$ A for a typical application when there is no output load. Note that the current in the feedback resistor divider appears to the output as load current.

While in Burst Mode operation the current limit of the top switch is approximately 2A (as shown in Figure 3), resulting in low output voltage ripple. Increasing the output capacitance will decrease output ripple proportionally. As load ramps upward from zero the switching frequency will increase but only up to the switching frequency programmed by the resistor at the RT pin as shown in Figure 2.

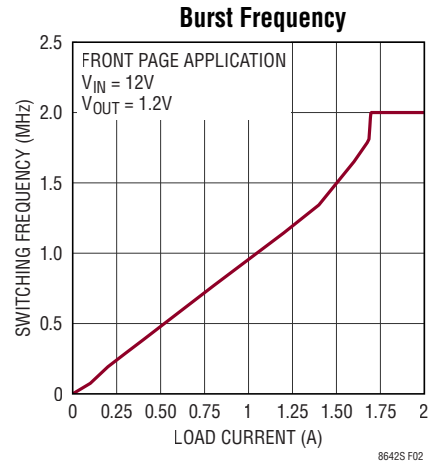

**Figure 2. SW Frequency vs Load Information in Burst Mode Operation**

The output load at which the LT8642S reaches the programmed frequency varies based on input voltage, output voltage and inductor choice. To select low ripple Burst Mode operation, tie the SYNC/MODE pin below 0.4V (this can be ground or a logic low output).

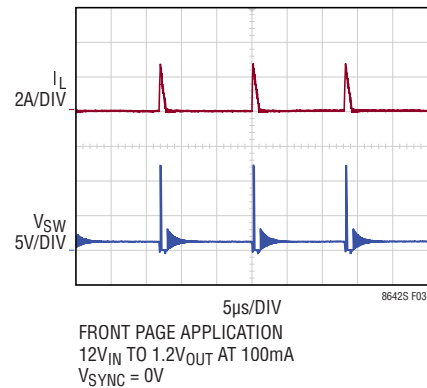

**Figure 3. Burst Mode Operation**

## APPLICATIONS INFORMATION

### Forced Continuous Mode

The LT8642S can operate in forced continuous mode (FCM) for fast transient response and full frequency operation over a wide load range. When in FCM, the oscillator operates continuously and positive SW transitions are aligned to the clock. Negative inductor current is allowed at light loads or under large transient conditions. The LT8642S can sink current from the output and return this charge to the input in this mode, improving load step transient response (see Figure 4). At light loads, FCM operation is less efficient than Burst Mode operation, but may be desirable in applications where it is necessary to keep switching harmonics out of the signal band. FCM must be used if the output is required to sink current. To enable FCM, float the SYNC/MODE pin. Leakage current on this pin should be  $<1\mu\text{A}$ . See Block Diagram for internal pull-up and pull-down resistance.

FCM is disabled if the  $V_{\text{IN}}$  pin is held above 17.5V or if the FB pin is held greater than 7% above the feedback reference voltage. FCM is also disabled during soft-start until the soft-start capacitor is fully charged ( $\sim 2\text{V}$ ). When FCM is disabled in these ways, negative inductor current is not allowed and the LT8642S operates in pulse-skipping mode.

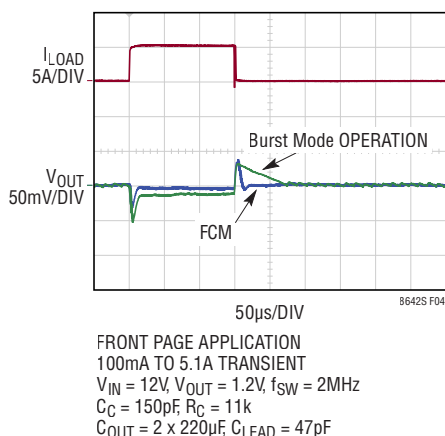

**Figure 4. Load Step Transient Response with and without Forced Continuous Mode**

### Spread Spectrum Mode

The LT8642S features spread spectrum operation to further reduce EMI emissions. To enable spread spectrum operation, the SYNC/MODE pin should be tied high to  $\text{INTV}_{\text{CC}}$  (or  $>3\text{V}$ ). In this mode, triangular frequency modulation is used to vary the switching frequency between the value programmed by RT to approximately 20% higher than that value. The modulation frequency is approximately 3kHz. For example, when the LT8642S is programmed to 2MHz, the frequency will vary from 2MHz to 2.4MHz at a 3kHz rate. When spread spectrum operation is selected, Burst Mode operation is disabled, and the part will run in forced continuous mode.

### Synchronization

To synchronize the LT8642S oscillator to an external frequency, connect a square wave to the SYNC/MODE pin. The square wave amplitude should have valleys that are below 0.4V and peaks above 1.5V (up to 6V), with a minimum on-time and off-time of 50ns.

The LT8642S will not enter Burst Mode operation at low output loads while synchronized to an external clock, but instead will run forced continuous mode to maintain regulation. The LT8642S may be synchronized over a 200kHz to 3MHz range. The RT resistor should be chosen to set the LT8642S switching frequency equal to or below the lowest synchronization input. For example, if the synchronization signal will be 500kHz and higher, the RT should be selected for 500kHz. The slope compensation is set by the RT value, while the minimum slope compensation required to avoid subharmonic oscillations is established by the inductor size, input voltage and output voltage. Since the synchronization frequency will not change the slopes of the inductor current waveform, if the inductor is large enough to avoid subharmonic oscillations at the frequency set by RT, then the slope compensation will be sufficient for all synchronization frequencies.

## APPLICATIONS INFORMATION

### FB Resistor Network

The output voltage is programmed with a resistor divider between the output and the FB pin. Choose the resistor values according to:

$$R1 = R2 \left( \frac{V_{OUT}}{0.597V} - 1 \right) \quad (1)$$

Reference designators refer to the Block Diagram. 1% resistors are recommended to maintain output voltage accuracy.

When using large FB resistors, a 4.7pF to 47pF phase-lead capacitor should be connected from  $V_{OUT}$  to FB.

### Setting the Switching Frequency

The LT8642S uses a constant frequency PWM architecture that can be programmed to switch from 200kHz to 3MHz by using a resistor tied from the RT pin to ground. A table showing the necessary  $R_T$  value for a desired switching frequency is in Table 1.

The  $R_T$  resistor required for a desired switching frequency can be calculated using:

$$R_T = \frac{46.5}{f_{SW}} - 5.2 \quad (2)$$

where  $R_T$  is in  $k\Omega$  and  $f_{SW}$  is the desired switching frequency in MHz.

**Table 1. SW Frequency vs  $R_T$  Value**

$f_{SW}$ (MHz)	$R_T$ ( $k\Omega$ )
0.2	232
0.3	150
0.4	110
0.5	88.7
0.6	71.5
0.7	60.4
0.8	52.3
1.0	41.2
1.2	33.2
1.4	28.0
1.6	23.7
1.8	20.5
2.0	17.8
2.2	15.8
3.0	10.7

### Operating Frequency Selection and Trade-Offs

Selection of the operating frequency is a trade-off between efficiency, component size, and input voltage range. The advantage of high frequency operation is that smaller inductor and capacitor values may be used. The disadvantages are lower efficiency and a smaller input voltage range.

The highest switching frequency ( $f_{SW(MAX)}$ ) for a given application can be calculated as follows:

$$f_{SW(MAX)} = \frac{V_{OUT} + V_{SW(BOT)}}{t_{ON(MIN)} (V_{IN} - V_{SW(TOP)} + V_{SW(BOT)})} \quad (3)$$

where  $V_{IN}$  is the typical input voltage,  $V_{OUT}$  is the output voltage,  $V_{SW(TOP)}$  and  $V_{SW(BOT)}$  are the internal switch drops (~0.2V, ~0.1V, respectively at maximum load) and  $t_{ON(MIN)}$  is the minimum top switch on-time (see the Electrical Characteristics). This equation shows that a slower switching frequency is necessary to accommodate a high  $V_{IN}/V_{OUT}$  ratio.



## APPLICATIONS INFORMATION

For transient operation,  $V_{IN}$  may go as high as the absolute maximum rating of 18V regardless of the  $R_T$  value, however the LT8642S will reduce switching frequency as necessary to maintain control of inductor current to assure safe operation.

The LT8642S is capable of a maximum duty cycle of approximately 99%, and the  $V_{IN}$ -to- $V_{OUT}$  dropout is limited by the  $R_{DS(ON)}$  of the top switch. In this mode the LT8642S skips switch cycles, resulting in a lower switching frequency than programmed by  $R_T$ .

For applications that cannot allow deviation from the programmed switching frequency at low  $V_{IN}/V_{OUT}$  ratios use the following formula to set switching frequency:

$$V_{IN(MIN)} = \frac{V_{OUT} + V_{SW(BOT)}}{1 - f_{SW} \cdot t_{OFF(MIN)}} - V_{SW(BOT)} + V_{SW(TOP)} \quad (4)$$

where  $V_{IN(MIN)}$  is the minimum input voltage without skipped cycles,  $V_{OUT}$  is the output voltage,  $V_{SW(TOP)}$  and  $V_{SW(BOT)}$  are the internal switch drops ( $\sim 0.2V$ ,  $\sim 0.1V$ , respectively at maximum load),  $f_{SW}$  is the switching frequency (set by  $R_T$ ), and  $t_{OFF(MIN)}$  is the minimum switch off-time. Note that higher switching frequency will increase the minimum input voltage below which cycles will be dropped to achieve higher duty cycle.

### Inductor Selection and Maximum Output Current

The LT8642S is designed to minimize solution size by allowing the inductor to be chosen based on the output load requirements of the application. During overload or short-circuit conditions the LT8642S safely tolerates operation with a saturated inductor through the use of a high speed peak-current mode architecture.

A good first choice for the inductor value is:

$$L = \left( \frac{V_{OUT} + V_{SW(BOT)}}{f_{SW}} \right) \cdot 0.5 \quad (5)$$

where  $f_{SW}$  is the switching frequency in MHz,  $V_{OUT}$  is the output voltage,  $V_{SW(BOT)}$  is the bottom switch drop ( $\sim 0.1V$ ) and  $L$  is the inductor value in  $\mu H$ .

To avoid overheating and poor efficiency, an inductor must be chosen with an RMS current rating that is greater than the maximum expected output load of the application. In addition, the saturation current (typically labeled  $I_{SAT}$ ) rating of the inductor must be higher than the load current plus 1/2 of in inductor ripple current:

$$I_{L(PEAK)} = I_{LOAD(MAX)} + \frac{1}{2} \Delta I_L \quad (6)$$

where  $\Delta I_L$  is the inductor ripple current as calculated in Equation 8 and  $I_{LOAD(MAX)}$  is the maximum output load for a given application.

As a quick example, an application requiring 3A output should use an inductor with an RMS rating of greater than 3A and an  $I_{SAT}$  of greater than 4A. During long duration overload or short-circuit conditions, the inductor RMS rating requirement is greater to avoid overheating of the inductor. To keep the efficiency high, the series resistance (DCR) should be less than  $0.01\Omega$ , and the core material should be intended for high frequency applications.

The LT8642S limits the peak switch current in order to protect the switches and the system from overload faults. The top switch current limit ( $I_{LIM}$ ) is 18A at low duty cycles and decreases linearly to 13.5A at  $DC = 0.8$ . The inductor value must then be sufficient to supply the desired maximum output current ( $I_{OUT(MAX)}$ ), which is a function of the switch current limit ( $I_{LIM}$ ) and the ripple current.

$$I_{OUT(MAX)} = I_{LIM} - \frac{\Delta I_L}{2} \quad (7)$$

The peak-to-peak ripple current in the inductor can be calculated as follows:

$$\Delta I_L = \frac{V_{OUT}}{L \cdot f_{SW}} \cdot \left( 1 - \frac{V_{OUT}}{V_{IN(MAX)}} \right) \quad (8)$$

where  $f_{SW}$  is the switching frequency of the LT8642S, and  $L$  is the value of the inductor. Therefore, the maximum output current that the LT8642S will deliver depends on

## APPLICATIONS INFORMATION

the switch current limit, the inductor value, and the input and output voltages. The inductor value may have to be increased if the inductor ripple current does not allow sufficient maximum output current ( $I_{OUT(MAX)}$ ) given the switching frequency, and maximum input voltage used in the desired application.

The optimum inductor for a given application may differ from the one indicated by this design guide. A larger value inductor provides a higher maximum load current and reduces the output voltage ripple. For applications requiring smaller load currents, the value of the inductor may be lower and the LT8642S may operate with higher ripple current. This allows use of a physically smaller inductor, or one with a lower DCR resulting in higher efficiency. Be aware that low inductance may result in discontinuous mode operation, which further reduces maximum load current.

For more information about maximum output current and discontinuous operation, see Linear Technology's Application Note 44.

For duty cycles greater than 50% ( $V_{OUT}/V_{IN} > 0.5$ ), a minimum inductance is required to avoid sub-harmonic oscillation. See Application Note 19.

### Input Capacitors

The  $V_{IN}$  of the LT8642S should be bypassed with at least three ceramic capacitors for best performance. Two small ceramic capacitors of  $<1\mu\text{F}$  can be placed close to the part; one on each side of the device ( $C_{OPT1}$ ,  $C_{OPT2}$ ). These capacitors should be 0402 or 0603 in size. For automotive applications requiring 2 series input capacitors, two small 0402 or 0603 may be placed at each side of the LT8642S near the  $V_{IN}$  and GND pins.

A third, larger ceramic capacitor of  $4.7\mu\text{F}$  or larger should be placed close to  $C_{OPT1}$  or  $C_{OPT2}$ . See layout section for more detail. X7R or X5R capacitors are recommended for best performance across temperature and input voltage variations.

Note that larger input capacitance is required when a lower switching frequency is used. If the input power source has high impedance, or there is significant inductance due to long wires or cables, additional bulk capacitance may be necessary. This can be provided with a low performance electrolytic capacitor.

A ceramic input capacitor combined with trace or cable inductance forms a high quality (under damped) tank circuit. If the LT8642S circuit is plugged into a live supply, the input voltage can ring to twice its nominal value, possibly exceeding the LT8642S's voltage rating. This situation is easily avoided (see Linear Technology Application Note 88).

### Output Capacitor and Output Ripple

The output capacitor has two essential functions. Along with the inductor, it filters the square wave generated by the LT8642S to produce the DC output. In this role it determines the output ripple, thus low impedance at the switching frequency is important. The second function is to store energy in order to satisfy transient loads and stabilize the LT8642S's control loop. Ceramic capacitors have very low equivalent series resistance (ESR) and provide the best ripple performance. For good starting values, see the Typical Applications section.

Use X5R or X7R types. This choice will provide low output ripple and good transient response. Transient performance can be improved with a higher value output capacitor and the addition of a feedforward capacitor placed between  $V_{OUT}$  and FB. Increasing the output capacitance will also decrease the output voltage ripple. A lower value of output capacitor can be used to save space and cost but transient performance will suffer and may cause loop instability. See the Typical Applications in this data sheet for suggested capacitor values.

When choosing a capacitor, special attention should be given to the data sheet to calculate the effective capacitance under the relevant operating conditions of voltage bias and temperature. A physically larger capacitor or one with a higher voltage rating may be required.

## APPLICATIONS INFORMATION

### Ceramic Capacitors

Ceramic capacitors are small, robust and have very low ESR. However, ceramic capacitors can cause problems when used with the LT8642S due to their piezoelectric nature. When in Burst Mode operation, the LT8642S's switching frequency depends on the load current, and at very light loads the LT8642S can excite the ceramic capacitor at audio frequencies, generating audible noise. Since the LT8642S operates at a lower current limit during Burst Mode operation, the noise is typically very quiet to a casual ear. If this is unacceptable, use a high performance tantalum or electrolytic capacitor at the output. Low noise ceramic capacitors are also available.

A final precaution regarding ceramic capacitors concerns the maximum input voltage rating of the LT8642S. As previously mentioned, a ceramic input capacitor combined with trace or cable inductance forms a high quality (under-damped) tank circuit. If the LT8642S circuit is plugged into a live supply, the input voltage can ring to twice its nominal value, possibly exceeding the LT8642S's rating. This situation is easily avoided (see Linear Technology Application Note 88).

### Enable Pin

The LT8642S is in shutdown when the EN pin is low and active when the pin is high. The rising threshold of the EN comparator is 0.99V, with 40mV of hysteresis. The EN pin can be tied to  $V_{IN}$  if the shutdown feature is not used, or tied to a logic level if shutdown control is required.

Adding a resistor divider from  $V_{IN}$  to EN programs the LT8642S to regulate the output only when  $V_{IN}$  is above a desired voltage (see the Block Diagram). Typically, this threshold,  $V_{IN(EN)}$ , is used in situations where the input supply is current limited, or has a relatively high source resistance. A switching regulator draws constant power from the source, so source current increases as source voltage drops. This looks like a negative resistance load to the source and can cause the source to current limit or latch low under low source voltage conditions. The  $V_{IN(EN)}$  threshold prevents the regulator from operating at source voltages where the problems might occur. This threshold

can be adjusted by setting the values R3 and R4 such that they satisfy the following equation:

$$V_{IN(EN)} = \left( \frac{R3}{R4} + 1 \right) \cdot 0.99V \quad (9)$$

where the LT8642S will remain off until  $V_{IN}$  is above  $V_{IN(EN)}$ . Due to the comparator's hysteresis, switching will not stop until the input falls slightly below  $V_{IN(EN)}$ .

When operating in Burst Mode operation for light load currents, the current through the  $V_{IN(EN)}$  resistor network can easily be greater than the supply current consumed by the LT8642S. Therefore, the  $V_{IN(EN)}$  resistors should be large to minimize their effect on efficiency at low loads.

### INTV<sub>CC</sub> Regulator

An internal low dropout (LDO) regulator produces the 3.4V supply from  $V_{IN}$  that powers the drivers and the internal bias circuitry. The INTV<sub>CC</sub> can supply enough current for the LT8642S's circuitry. To improve efficiency the internal LDO can also draw current from the BIAS pin when the BIAS pin is at 3.1V or higher. Typically the BIAS pin can be tied to the output of the LT8642S, or can be tied to an external supply of 3.3V or above. If BIAS is connected to a supply other than  $V_{OUT}$ , be sure to bypass with a local ceramic capacitor. If the BIAS pin is below 3.0V, the internal LDO will consume current from  $V_{IN}$ . Applications with high input voltage and high switching frequency where the internal LDO pulls current from  $V_{IN}$  will increase die temperature because of the higher power dissipation across the LDO. Do not connect an external load to the INTV<sub>CC</sub> pin.

### Frequency Compensation

Loop compensation determines the stability and transient performance, and is provided by the components tied to the  $V_C$  pin. Generally, a capacitor ( $C_C$ ) and a resistor ( $R_C$ ) in series to ground are used. Designing the compensation network is a bit complicated and the best values depend on the application. A practical approach is to start with one of the circuits in this data sheet that is similar to your application and tune the compensation network to optimize the performance. Simulation can help

## APPLICATIONS INFORMATION

in this process. Stability should then be checked across all operating conditions, including load current, input voltage and temperature. The LT1375 data sheet contains a more thorough discussion of loop compensation and describes how to test the stability using a transient load.

Figure 5 shows an equivalent circuit for the LT8642S control loop. The error amplifier is a transconductance amplifier with finite output impedance. The power section, consisting of the modulator, power switches, and inductor, is modeled as a transconductance amplifier generating an output current proportional to the voltage at the  $V_C$  pin. Note that the output capacitor integrates this current, and that the capacitor on the  $V_C$  pin ( $C_C$ ) integrates the error amplifier output current, resulting in two poles in the loop. A zero is required and comes from a resistor  $R_C$  in series with  $C_C$ . This simple model works well as long as the value of the inductor is not too high and the loop crossover frequency is much lower than the switching frequency. A phase lead capacitor ( $C_{PL}$ ) across the feedback divider can be used to improve the transient response and is required to cancel the parasitic pole caused by the feedback node to ground capacitance.

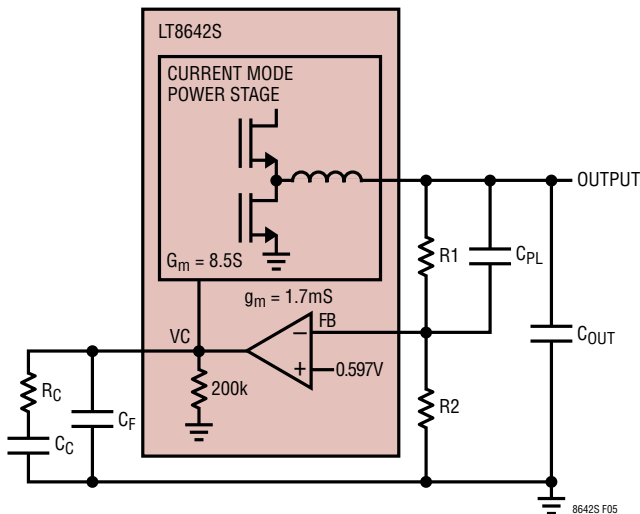

Figure 5. Model for Loop Response

Table 2 provides a guideline for the compensation values of several typical applications. Slight tweaks to these values may be required depending on the specific application. All applications were using  $C_{OUT} = 220\mu\text{F} \times 2$ ,  $C_{PL} = 47\text{pF}$ , and  $R1 = 100\text{k}$ .

Table 2. Compensation Values

$V_{OUT}$	$f_{sw}$	$C_C$	$R_C$
1.0V	1MHz	470pF	7.68k
1.0V	2MHz	330pF	10.2k
1.2V	1MHz	680pF	10.2k
1.2V	2MHz	150pF	11k
3.3V	1MHz	220pF	6.98k
3.3V	2MHz	150pF	9.31k

### Output Voltage Tracking and Soft-Start

The LT8642S allows the user to program its output voltage ramp rate by means of the SS pin. An internal  $1.9\mu\text{A}$  pulls up the SS pin to  $INTV_{CC}$ . Putting an external capacitor on SS enables soft starting the output to prevent current surge on the input supply. During the soft-start ramp the output voltage will proportionally track the SS pin voltage. For output tracking applications, SS can be externally driven by another voltage source. From 0V to 1V, the SS voltage will override the internal 0.597V reference input to the error amplifier, thus regulating the FB pin voltage to a function of the SS pin. See plot in Typical Performance Characteristics section. When SS is above 1V, tracking is disabled and the feedback voltage will regulate to the internal reference voltage. The SS pin may be left floating if the function is not needed.

An active pull-down circuit is connected to the SS pin which will discharge the external soft-start capacitor in the case of fault conditions and restart the ramp when the faults are cleared. Fault conditions that clear the soft-start capacitor are the EN/UV pin transitioning low,  $V_{IN}$  voltage falling too low, or thermal shutdown.

## APPLICATIONS INFORMATION

### Output Power Good

When the LT8642S's output voltage is within the  $\pm 8\%$  window of the regulation point, the output voltage is considered good and the open-drain PG pin goes high impedance and is typically pulled high with an external resistor. Otherwise, the internal pull-down device will pull the PG pin low. To prevent glitching both the upper and lower thresholds include 0.4% of hysteresis. PG is valid when  $V_{IN}$  is above 2.8V.

The PG pin is also actively pulled low during several fault conditions: EN/UV pin is below 0.99V,  $INTV_{CC}$  has fallen too low,  $V_{IN}$  is too low, or thermal shutdown.

### Paralleling

To increase the possible output current, two LT8642Ss can be connected in parallel to the same output. To do this, the  $V_C$  and FB pins are connected together, and each LT8642S's SW node is connected to the common output through its own inductor. The CLKOUT pin of one LT8642S should be connected to the SYNC/MODE pin of the second LT8642S to have both devices operate in the same mode. During FCM, Spread Spectrum, and Synchronization modes, both devices will operate at the same frequency and phase. Figure 6 shows an application where two LT8642Ss are paralleled to get one output capable of up to 20A.

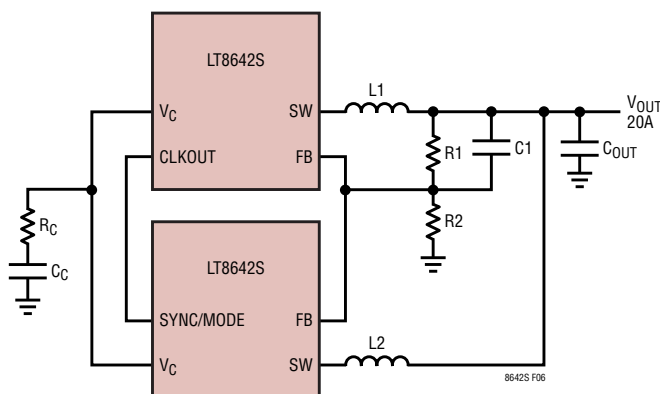

Figure 6. Paralleling Two LT8642Ss

### Shorted and Reversed Input Protection

The LT8642S will tolerate a shorted output. Several features are used for protection during output short-circuit and brownout conditions. The first is the switching frequency will be folded back while the output is lower than the set point to maintain inductor current control. Second, the bottom switch current is monitored such that if inductor current is beyond safe levels switching of the top switch will be delayed until such time as the inductor current falls to safe levels.

Frequency foldback behavior depends on the state of the SYNC pin: If the SYNC pin is low the switching frequency will slow while the output voltage is lower than the programmed level. If the SYNC pin is connected to a clock source, floated or tied high, the LT8642S will stay at the programmed frequency without foldback and only slow switching if the inductor current exceeds safe levels.

There is another situation to consider in systems where the output will be held high when the input to the LT8642S is absent. This may occur in battery charging applications or in battery-backup systems where a battery or some other supply is diode ORed with the LT8642S's output. If the  $V_{IN}$  pin is allowed to float and the EN pin is held high (either by a logic signal or because it is tied to  $V_{IN}$ ), then the LT8642S's internal circuitry will pull its quiescent current through its SW pin. This is acceptable if the system can tolerate current draw in this state. If the EN pin is grounded the SW pin current will drop to near  $1\mu A$ . However, if the  $V_{IN}$  pin is grounded while the output is held high, regardless of EN, parasitic body diodes inside the LT8642S can pull current from the output through the SW pin and the  $V_{IN}$  pin. Figure 7 shows a connection of the  $V_{IN}$  and EN/UV pins that will allow the LT8642S to run only when the input voltage is present and that protects against a shorted or reversed input.

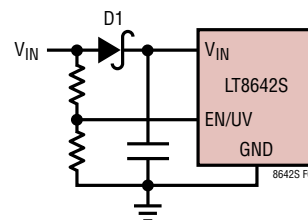

Figure 7. Reverse  $V_{IN}$  Protection

## APPLICATIONS INFORMATION

### Thermal Considerations

For higher ambient temperatures, care should be taken in the layout of the PCB to ensure good heat sinking of the LT8642S. The ground pins on the bottom of the package should be soldered to a ground plane. This ground should be tied to large copper layers below with thermal vias; these layers will spread heat dissipated by the LT8642S. Placing additional vias can reduce thermal resistance further. The maximum load current should be derated as the ambient temperature approaches the maximum junction rating. Power dissipation within the LT8642S can be estimated by calculating the total power loss from an efficiency measurement and subtracting the inductor loss. The die temperature is calculated by multiplying the LT8642S power dissipation by the thermal resistance from junction to ambient.

The internal overtemperature protection monitors the junction temperature of the LT8642S. If the junction temperature reaches approximately 165°C, the LT8642S will stop switching and indicate a fault condition until the temperature drops about 5°C cooler.

Temperature rise of the LT8642S is worst when operating at high load, high  $V_{IN}$ , and high switching frequency. If the case temperature is too high for a given application, then either  $V_{IN}$ , switching frequency, or load current can be decreased to reduce the temperature to an acceptable level. Figure 8 shows examples of how case temperature rise can be managed by reducing switching frequency or load.

The LT8642S's top switch current limit decreases with higher duty cycle operation for slope compensation. This also limits the output current the LT8642S can deliver for a given application. See curve in Typical Performance Characteristics.

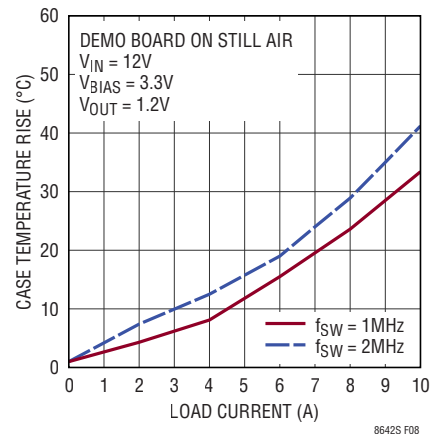

**Figure 8. Case Temperature Rise**

TYPICAL APPLICATIONS

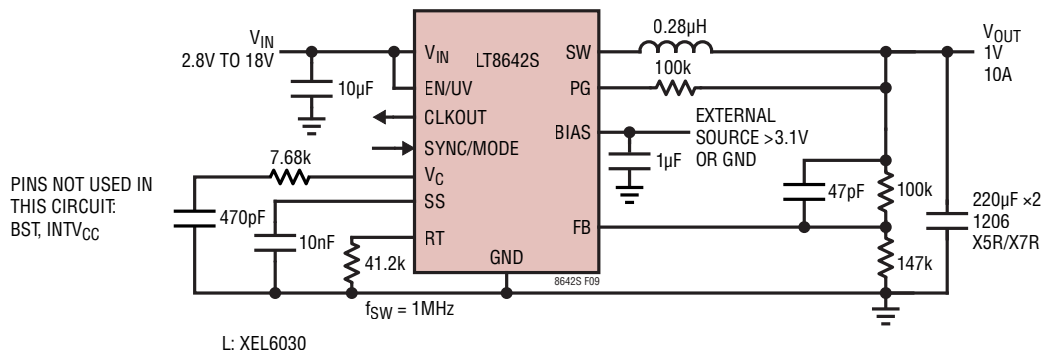

Figure 9. 1V 10A Step-Down Converter with Soft-Start and Power Good

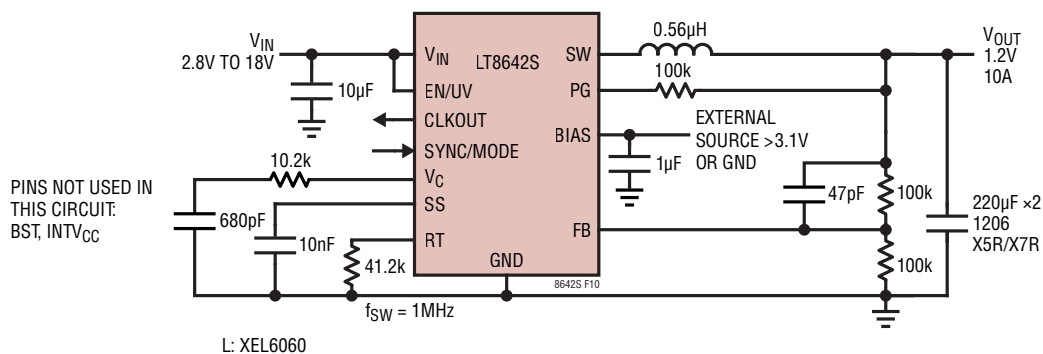

Figure 10. 1.2V, 10A Step-Down Converter with Soft-Start and Power Good

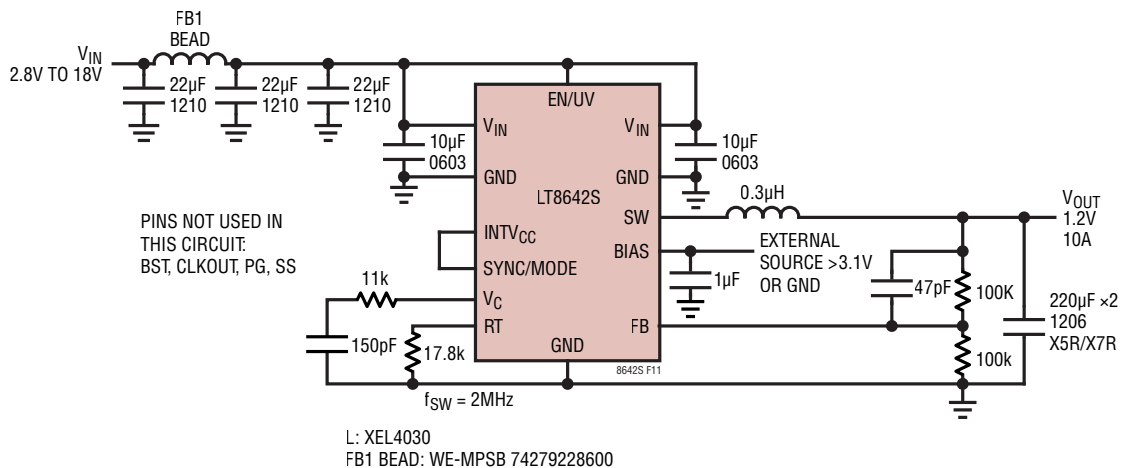

Figure 11. Ultralow EMI 2MHz 1.2V, 10A Step-Down Converter with Spread Spectrum

## TYPICAL APPLICATIONS

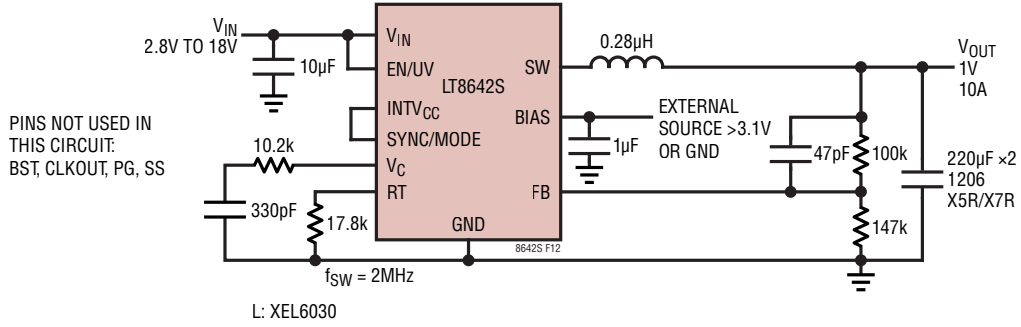

Figure 12. 2MHz 1V, 10A Step-Down Converter with Spread Spectrum

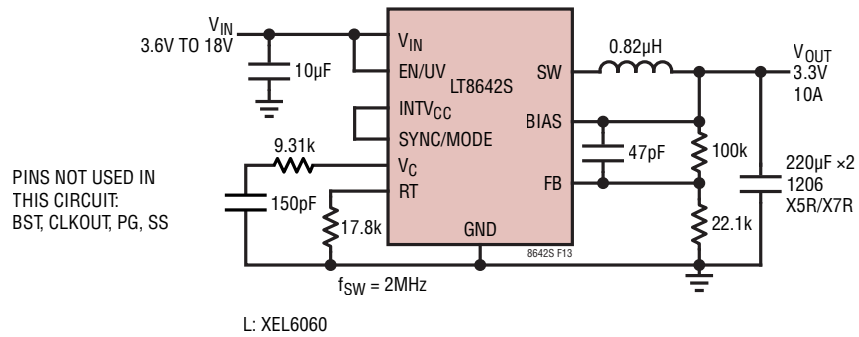

Figure 13. 2MHz 3.3V, 10A Step-Down Converter with Spread Spectrum



# PACKAGE DESCRIPTION

Please refer to <http://www.linear.com/product/LT8642S#packaging> for the most recent package drawings.

**LQFN Package**  
**24-Lead (4mm x 4mm x 0.94mm)**  
 (Reference LTC DWG # 05-08-1511 Rev C)

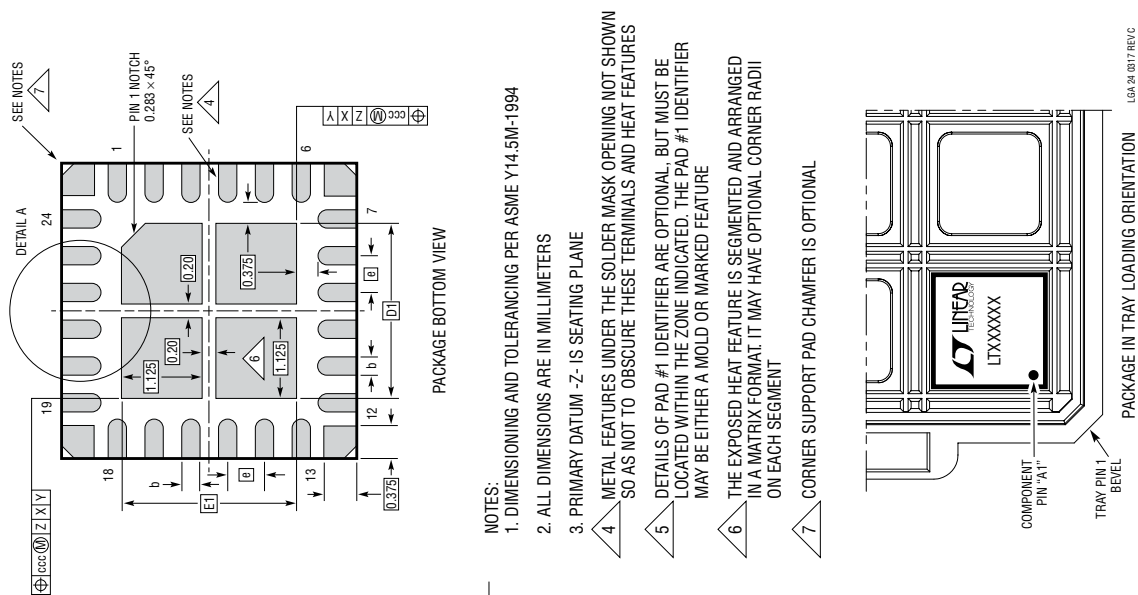

- NOTES:**
1. DIMENSIONING AND TOLERANCING PER ASME Y14.5M-1994
  2. ALL DIMENSIONS ARE IN MILLIMETERS
  3. PRIMARY DATUM - Z - IS SEATING PLANE
  4. METAL FEATURES UNDER THE SOLDER MASK OPENING NOT SHOWN SO AS NOT TO OBSCURE THESE TERMINALS AND HEAT FEATURES
  5. DETAILS OF PAD #1 IDENTIFIER ARE OPTIONAL, BUT MUST BE LOCATED WITHIN THE ZONE INDICATED. THE PAD #1 IDENTIFIER MAY BE EITHER A MOLD OR MARKED FEATURE
  6. THE EXPOSED HEAT FEATURE IS SEGMENTED AND ARRANGED IN A MATRIX FORMAT. IT MAY HAVE OPTIONAL CORNER RADII ON EACH SEGMENT
  7. CORNER SUPPORT PAD CHAMFER IS OPTIONAL

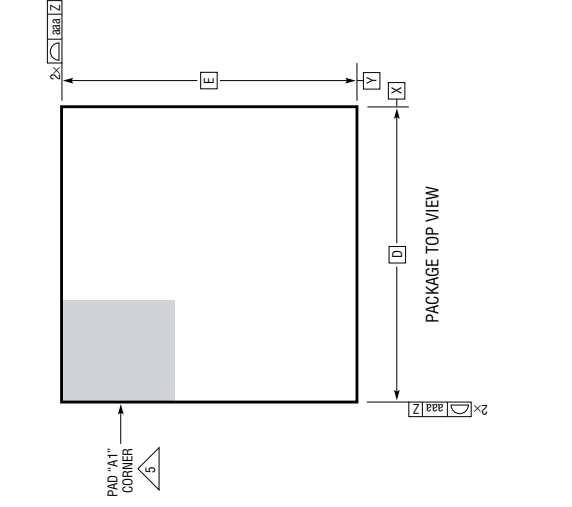
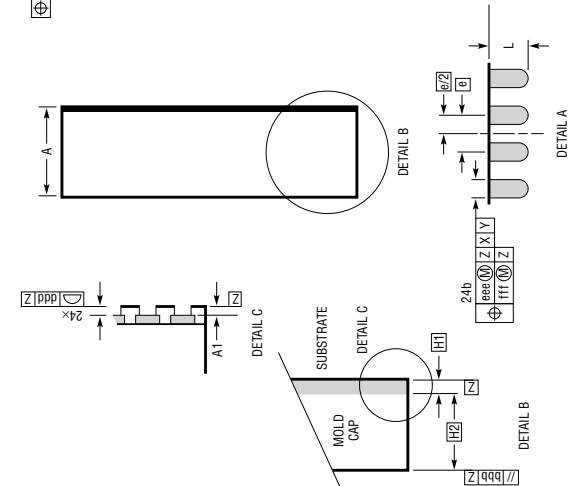
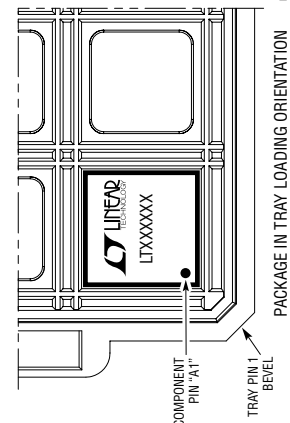

DIMENSIONS				
SYMBOL	MIN	NOM	MAX	NOTES
A	0.85	0.94	1.03	
A1	0.01	0.02	0.03	
L	0.30	0.40	0.50	
b	0.22	0.25	0.28	
D		4.00		
E		4.00		
D1		2.45		
E1		2.45		
e		0.50		
H1		0.24		
H2		0.70		
aaa			0.10	
bbb			0.10	
ccc			0.10	
ddd			0.10	
eee			0.15	
fff			0.08	

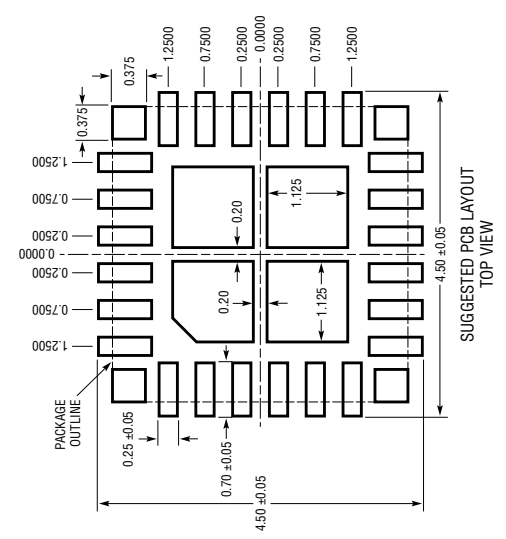

Information furnished by Analog Devices is believed to be accurate and reliable. However, no responsibility is assumed by Analog Devices for its use, nor for any infringements of patents or other rights of third parties that may result from its use. Specifications subject to change without notice. No license is granted by implication or otherwise under any patent or patent rights of Analog Devices.

## TYPICAL APPLICATIONS

### 3.3V, 10A Step-Down Converter

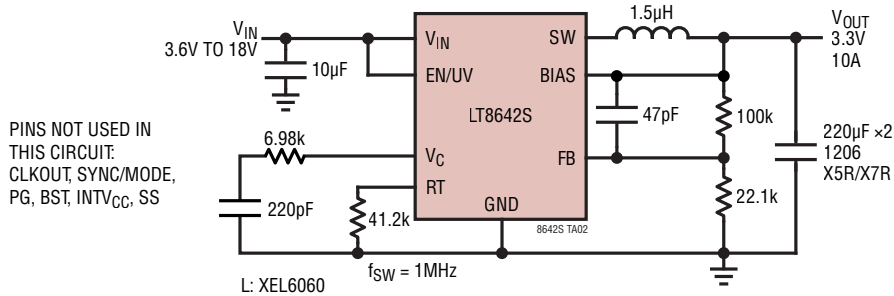

## RELATED PARTS

PART	DESCRIPTION	COMMENTS
LT8650S	42V, Dual 4A, 95% Efficiency, 2.2MHz Synchronous MicroPower Step-Down DC/DC Converter with I <sub>Q</sub> = 6.2µA	V <sub>IN(MIN)</sub> = 3V, V <sub>IN(MAX)</sub> = 42V, V <sub>OUT(MIN)</sub> = 0.8V, I <sub>Q</sub> = 6.2µA, I <sub>SD</sub> < 1µA, 4mm × 6mm LQFN-32
LT8640S/ LT8643S	42V, 6A Synchronous Step-Down Silent Switcher 2 with I <sub>Q</sub> = 2.5µA	V <sub>IN(MIN)</sub> = 3.4V, V <sub>IN(MAX)</sub> = 42V, V <sub>OUT(MIN)</sub> = 0.97V, I <sub>Q</sub> = 2.5µA, I <sub>SD</sub> < 1µA, 4mm × 4mm LQFN-24
LT8603	42V, Triple Output 95% Efficiency, 2.2MHz Synchronous MicroPower Step-Down with DC/DC Converter with Boost Controller	V <sub>IN(MIN)</sub> = 3V, V <sub>IN(MAX)</sub> = 42V, V <sub>OUT(MIN)</sub> = 0.8V, I <sub>Q</sub> = 28µA, I <sub>SD</sub> < 1µA, 6mm × 6mm QFN-40
LT8602	42V, Quad Output (2.5A + 1.5A + 1.5A + 1.5A) 95% Efficiency, 2.2MHz Synchronous MicroPower Step-Down DC/DC Converter with I <sub>Q</sub> = 25µA	V <sub>IN(MIN)</sub> = 3V, V <sub>IN(MAX)</sub> = 42V, V <sub>OUT(MIN)</sub> = 0.8V, I <sub>Q</sub> = 25µA, I <sub>SD</sub> < 1µA, 6mm × 6mm QFN-40
LT8645S/ LT8646S	65V, 8A, Synchronous Step-Down Silent Switcher 2 with I <sub>Q</sub> = 2.5µA	V <sub>IN(MIN)</sub> = 3.4V, V <sub>IN(MAX)</sub> = 65V, V <sub>OUT(MIN)</sub> = 0.97V, I <sub>Q</sub> = 2.5µA, I <sub>SD</sub> < 1µA, 6mm × 4mm LQFN-32
LT8640/ LT8640-1	42V, 5A, 96% Efficiency, 3MHz Synchronous MicroPower Step-Down DC/DC Converter with I <sub>Q</sub> = 2.5µA	V <sub>IN(MIN)</sub> = 3.4V, V <sub>IN(MAX)</sub> = 42V, V <sub>OUT(MIN)</sub> = 0.99V, I <sub>Q</sub> = 2.5µA, I <sub>SD</sub> < 1µA, 3mm × 4mm QFN-18
LT8641	65V, 3.5A, 95% Efficiency, 3MHz Synchronous MicroPower Step-Down DC/DC Converter with I <sub>Q</sub> = 2.5µA	V <sub>IN(MIN)</sub> = 3V, V <sub>IN(MAX)</sub> = 65V, V <sub>OUT(MIN)</sub> = 0.81V, I <sub>Q</sub> = 2.5µA, I <sub>SD</sub> < 1µA, 3mm × 4mm QFN-18
LT8609/ LT8609A	42V, 2A, 94% Efficiency, 2.2MHz Synchronous MicroPower Step-Down DC/DC Converter with I <sub>Q</sub> = 2.5µA	V <sub>IN(MIN)</sub> = 3V, V <sub>IN(MAX)</sub> = 42V, V <sub>OUT(MIN)</sub> = 0.8V, I <sub>Q</sub> = 2.5µA, I <sub>SD</sub> < 1µA, MSOP-10E
LT8610A/ LT8610AB	42V, 3.5A, 96% Efficiency, 2.2MHz Synchronous MicroPower Step-Down DC/DC Converter with I <sub>Q</sub> = 2.5µA	V <sub>IN(MIN)</sub> = 3.4V, V <sub>IN(MAX)</sub> = 42V, V <sub>OUT(MIN)</sub> = 0.97V, I <sub>Q</sub> = 2.5µA, I <sub>SD</sub> < 1µA, MSOP-16E
LT8611	42V, 2.5A, 96% Efficiency, 2.2MHz Synchronous MicroPower Step-Down DC/DC Converter with I <sub>Q</sub> = 2.5µA and Input/Output Current Limit/Monitor	V <sub>IN(MIN)</sub> = 3.4V, V <sub>IN(MAX)</sub> = 42V, V <sub>OUT(MIN)</sub> = 0.97V, I <sub>Q</sub> = 2.5µA, I <sub>SD</sub> < 1µA, 3mm × 5mm QFN-24
LT8616	42V, Dual 2.5A + 1.5A, 95% Efficiency, 2.2MHz Synchronous MicroPower Step-Down DC/DC Converter with I <sub>Q</sub> = 5µA	V <sub>IN(MIN)</sub> = 3.4V, V <sub>IN(MAX)</sub> = 42V, V <sub>OUT(MIN)</sub> = 0.8V, I <sub>Q</sub> = 5µA, I <sub>SD</sub> < 1µA, TSSOP-28E, 3mm × 6mm QFN-28
LT8620	65V, 2.5A, 94% Efficiency, 2.2MHz Synchronous MicroPower Step-Down DC/DC Converter with I <sub>Q</sub> = 2.5µA	V <sub>IN(MIN)</sub> = 3.4V, V <sub>IN(MAX)</sub> = 65V, V <sub>OUT(MIN)</sub> = 0.97V, I <sub>Q</sub> = 2.5µA, I <sub>SD</sub> < 1µA, MSOP-16E, 3mm × 5mm QFN-24
LT8614	42V, 4A, 96% Efficiency, 2.2MHz Synchronous Silent Switcher Step-Down DC/DC Converter with I <sub>Q</sub> = 2.5µA	V <sub>IN(MIN)</sub> = 3.4V, V <sub>IN(MAX)</sub> = 42V, V <sub>OUT(MIN)</sub> = 0.97V, I <sub>Q</sub> = 2.5µA, I <sub>SD</sub> < 1µA, 3mm × 4mm QFN-18
LT8612	42V, 6A, 96% Efficiency, 2.2MHz Synchronous MicroPower Step-Down DC/DC Converter with I <sub>Q</sub> = 2.5µA	V <sub>IN(MIN)</sub> = 3.4V, V <sub>IN(MAX)</sub> = 42V, V <sub>OUT(MIN)</sub> = 0.97V, I <sub>Q</sub> = 3.0µA, I <sub>SD</sub> < 1µA, 3mm × 6mm QFN-28