

**All information is subject to change without notice. Please read bottom notes.****FEATURES**

- (1) 10.4" VGA color display with High Luminance (400cd/m<sup>2</sup>)
- (2) Wide Viewing Angle ( Vertical : 100°, Horizontal : 120° )
- (3) Built in Long Life Lamps (Typ. : 50,000 h)
- (4) Mechanical compatible with LTM10C210 (10.4" VGA)
- (5) RoHS compatible

**TENTATIVE****RoHS compatible****MECHANICAL SPECIFICATIONS**

Item	Specifications
Dimensional Outline (typ.)	265.0 (W) x 188.8 (H) x 11.4 (D) (typ.) mm
Number of Pixels	640 (W) x 480 (H) pixels
Active Area	211.2 (W) x 158.4 (H) mm
Pixel Pitch	0.33 (W) x 0.33 (H)
Weight (approximately)	610g
Backlight	Sidelight ( 2 CCFLs )

**ABSOLUTE MAXIMUM RATINGS**

Item	Min.	Max.	Unit	
Supply Voltage	(V <sub>DD</sub> )	-0.3	6.5	V
	(V <sub>FL</sub> )	0	2.0	kV(rms)
FL Driving Frequency	(f <sub>FL</sub> )	---	100	kHz
Input Signal Voltage	(V <sub>IN</sub> )	-0.3	V <sub>DD</sub> +0.3	V
Operating Temperature		0	50	°C
Storage Temperature		-20	60	°C
Storage Humidity (Max. wet bulb temperature = 39°C)		10	90	%(RH)

**ELECTRICAL SPECIFICATION (Ta=25°C) (RECOMMENDED OPERATION CONDITION)**

Item	Min.	Typ.	Max.	Unit	Remarks	
Supply Voltage	(V <sub>DD</sub> )	4.75	5.0	5.25	V	
	(V <sub>FL</sub> )	---	480	---	V(rms)	
FL Start Voltage	(V <sub>SFL</sub> )	1500	---	---	V(rms)	Ta=0°C
High Level Input Voltage	(V <sub>IH</sub> )	3.5	---	V <sub>DD</sub>	V	
Low Level Input Voltage	(V <sub>IL</sub> )	0	---	1.5	V	
Current Consumption	(I <sub>DD</sub> ) <sup>*1</sup>	---	150	---	mA	
	(I <sub>FL</sub> ) <sup>*2</sup>	3.0	---	6.5	mA(rms)	
Power Consumption <sup>*1 *2</sup>		---	6.5	---	W	I <sub>FL</sub> =6.0mA(rms)

\*1 : 8 color bars pattern

\*2 : Except the efficiency of FL inverter

**OPTICAL SPECIFICATION (Ta=25°C)**

Item	Min.	Typ.	Max.	Unit	Remarks
Contrast Ratio	(CR)	100	250	---	---
Viewing Angle (CR ≥ 10)	(Upper+Lower)	---	100	---	°
	(Left+Right)	---	120	---	°
Response Time	(T <sub>ON</sub> )	---	15	50	ms
	(T <sub>OFF</sub> )	---	25	50	ms
Luminance	(L)	---	400	---	cd/m <sup>2</sup>
Lamp Life Time (MTBF) <sup>*3 *4</sup>			50,000		h

\*3 : Conditions ; Ta=25°C, I<sub>FL</sub>=6.0mA(rms), continuous lighting

\*4 : Definitions of failure ; 1) Lcd luminance becomes half of the minimum value. 2) Lamp doesn't light normally.

\*The information contained herein is presented only as a guide for the applications of our products. No responsibility is assumed by Toshiba Matsushita Display Technology or other rights of the third parties which may result from its use. No license is granted by implication or otherwise under any patent or patent rights of Toshiba Matsushita Display Technology or others.

\*The information contained herein may be changed without prior notice. It is therefore advisable to contact Toshiba Matsushita Display Technology before proceeding with the design of equipment incorporating this product.

**DIMENSIONAL OUTLINE**

**TENTATIVE**

Unit : mm

Standard tolerance : ±0.5

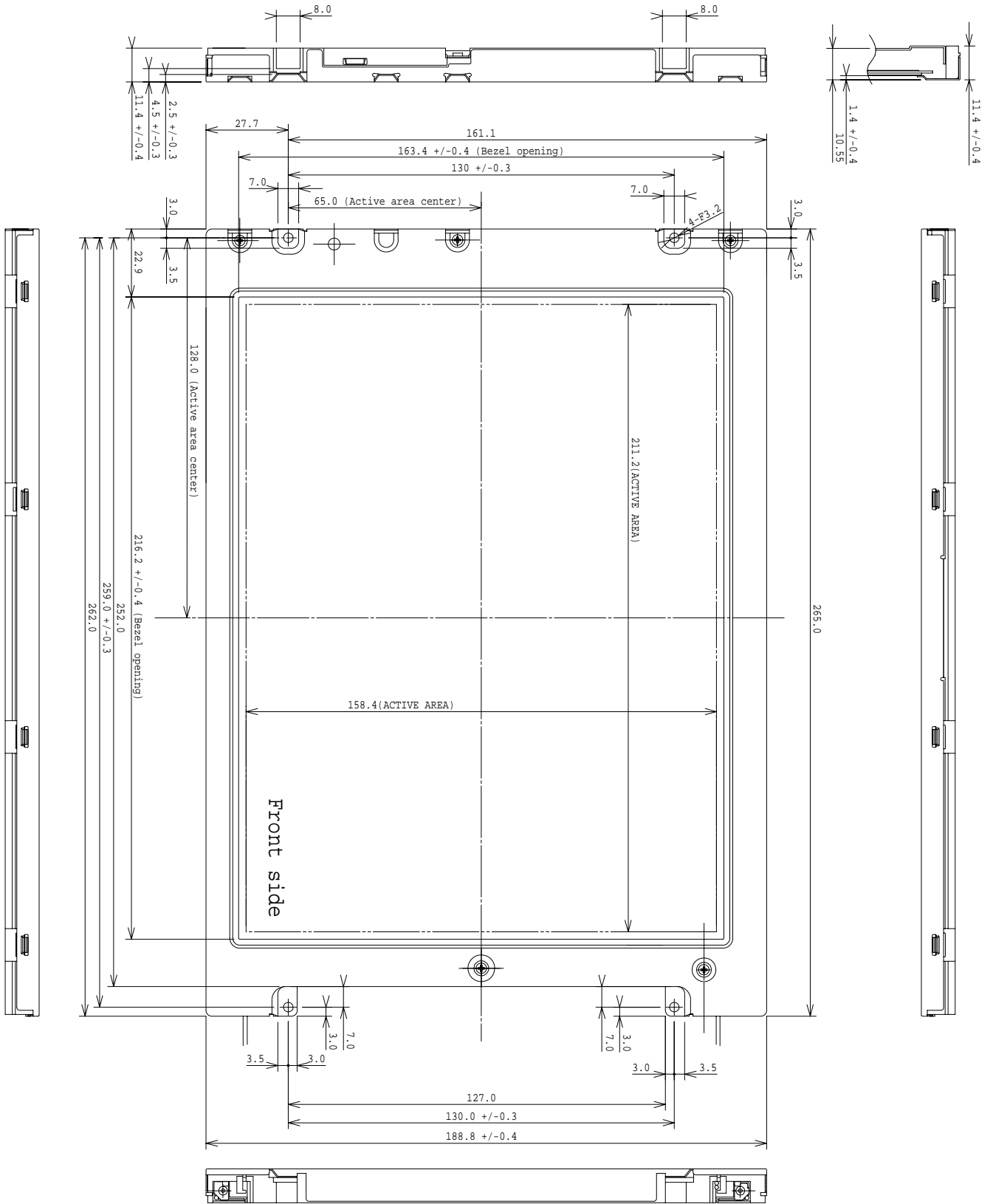

## DIMENSIONAL OUTLINE

**TENTATIVE**

Unit : mm

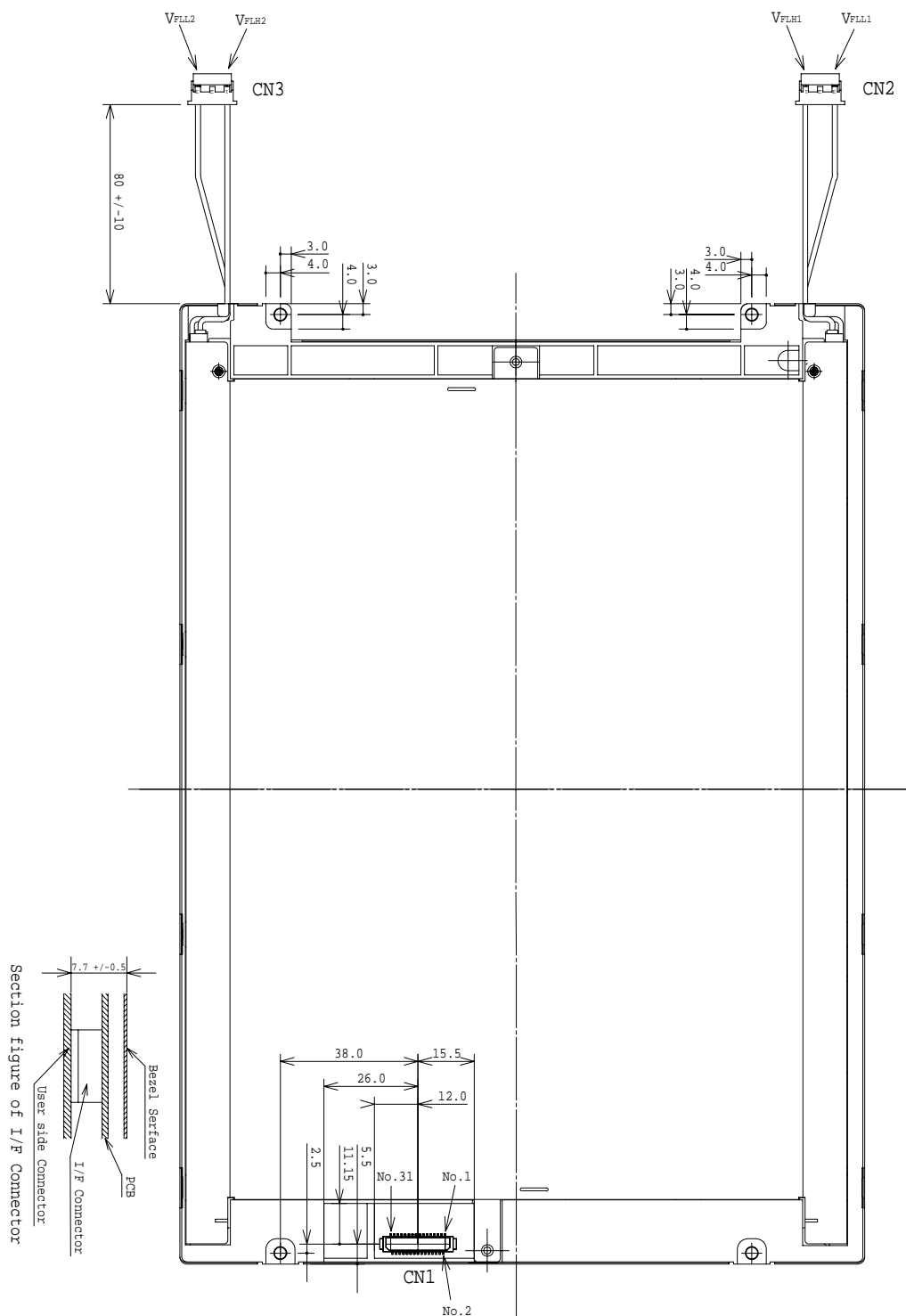
Standard tolerance :  $\pm 0.5$ 

Note) The different points between LTA104A261F and LTM10C210 are below.

- 1) The lamp unit of LTM10C210 can not use for LTA104A261F.
- 2) The depth of LTA104A261F is thinner than LTM10C210.
- 3) The rear structure is changed.

The Metal rear shield is added and the Plastic frame design is different from LTM10C210.

There are slight differences. (Refer to page.3 rear dimensional outline in detail.)

- 4) The absolute maximum Supply Voltage ( $V_{DD}$ ) of LTA104A261F is lower than LTM10C210.  
(Refer to page.1 Absolute Maximum ratings.)

**BLOCK DIAGRAM**

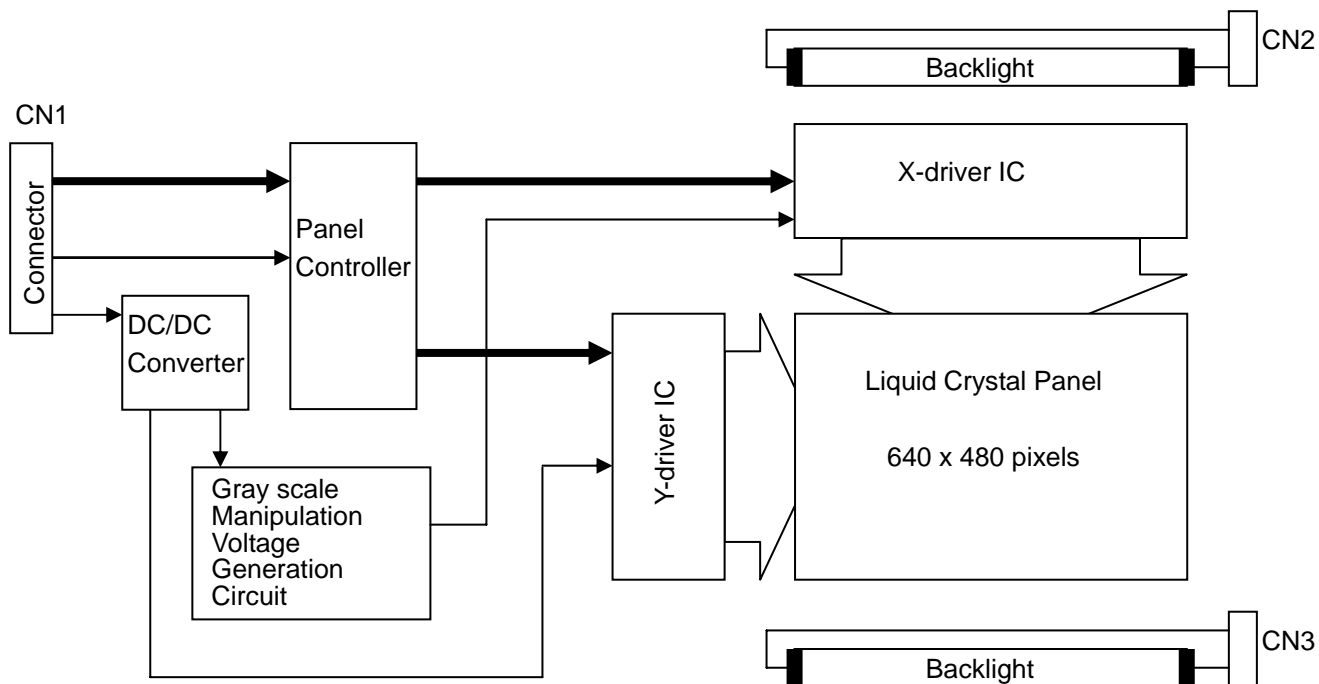

**SEQUENCE OF POWER SUPPLIES AND SIGNALS**

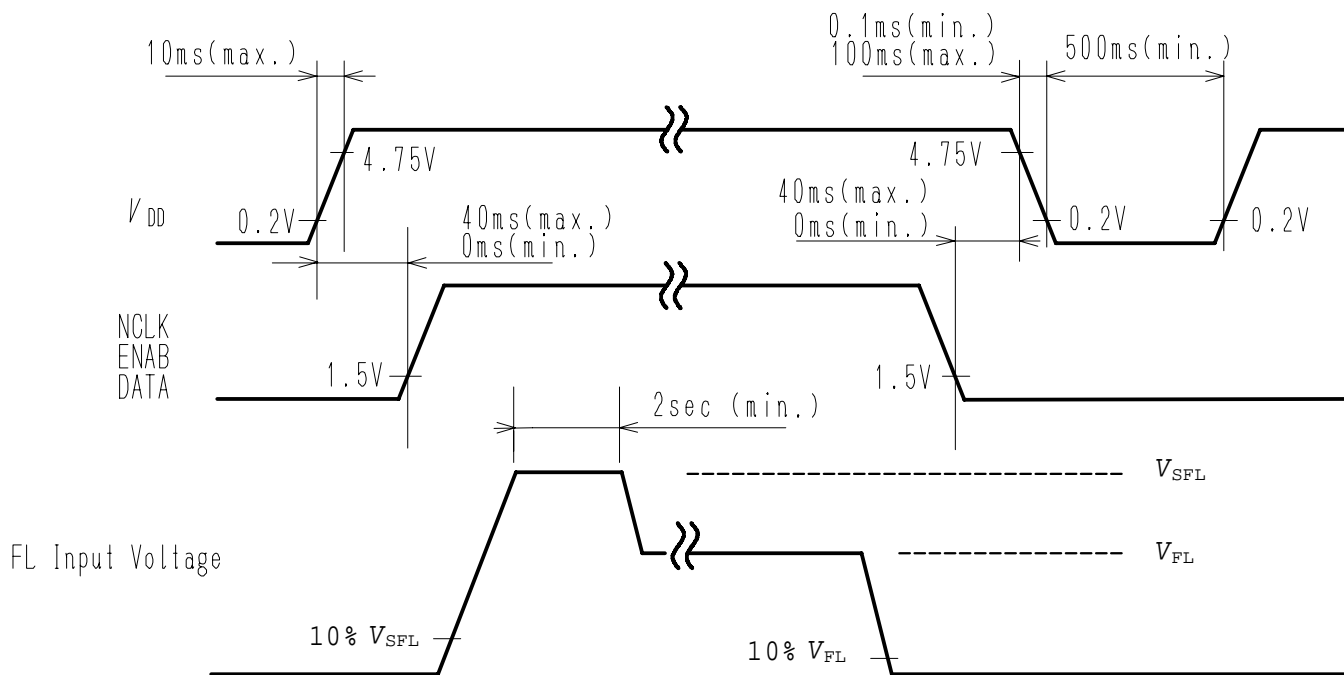

TIMING CHART

(1) Vertical Timing

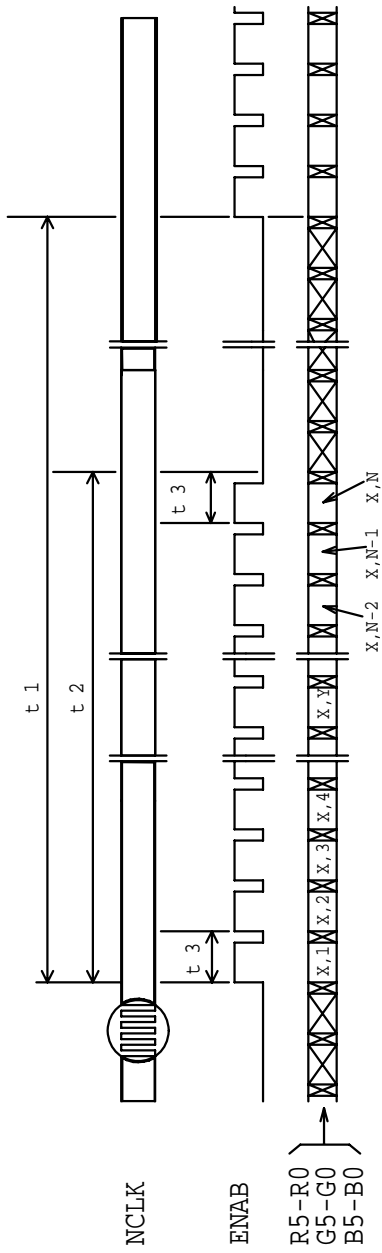

(2) Horizontal Timing

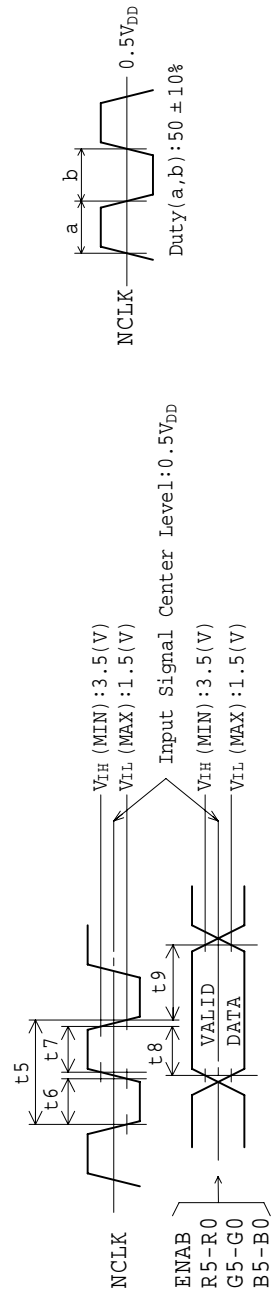
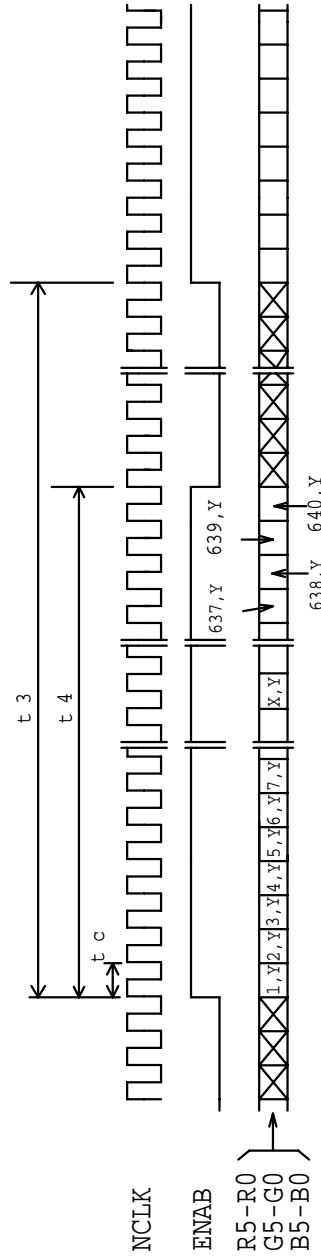

TIMING SPECIFICATION <sup>1) 2) 3) 4) 5) 6)</sup>

Item	Symbol	Min.	Typ.	Max.	Unit	Remarks
Frame Period	$t_1$	$249+N/2 \times t_3$	$525 \times t_3$ 16.68	$525 \times t_3$ 17.85	---	
Vertical Display Term	$t_2$	$480 \times t_3$	$480 \times t_3$	$480 \times t_3$	---	$t_2=N \times t_3$
One Line Scanning Time	$t_3$	$684 \times t_5$ 31.5	$800 \times t_5$ 31.78	$860 \times t_5$ ---	$\mu\text{s}$	
Horizontal Display Term	$t_4$	$640 \times t_5$	$640 \times t_5$	$640 \times t_5$	---	
Clock Period	$t_5$	35.0	39.72	---	ns	
Clock "L" Time	$t_6$	10.0	---	---	ns	
Clock "H" Time	$t_7$	7.0	---	---	ns	
Set Up Time	$t_8$	5.0	---	---	ns	
Hold Time	$t_9$	10.0	---	---	ns	

- Note 1) When ENAB is fixed to "H" level or "L" level after NCLK input, the panel is displayed as black. However, it may be occurred a flicker on the display.
- Note 2) When NCLK is fixed to "H" level or "L" level, the panel becomes white stage after several seconds.
- Note 3) Do not change  $t_1$  and  $t_3$  values in the operation. When  $t_1$  or  $t_3$  is changed, the panel is displayed as black.
- Note 4) Please adjust LCD operating signal timing and FL driving frequency, to optimize the display quality. There is a possibility that flicker is observed by the interference of LCD operating signal timing and FL driving condition (especially driving frequency).
- Note 5) When the vertical display period (N) is shorter than 480 lines, the actual display area is shifted to the center. Non-display areas become dark as follows.

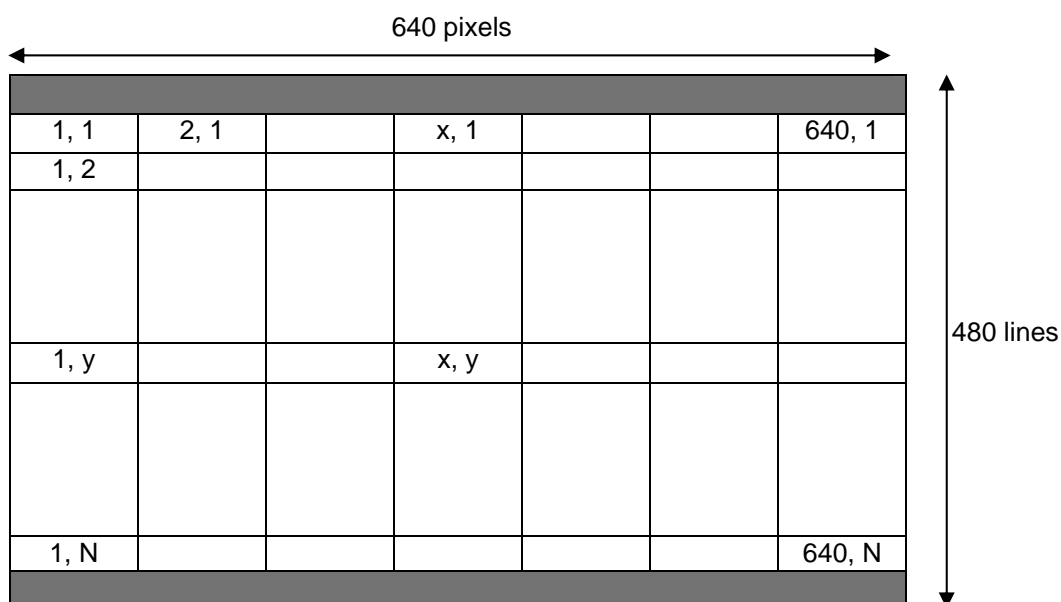

- Note 6) The following conditions should be met.
- NCLK count of each Horizontal Scanning Time should be always the same.
  - V-Blanking period should be "n" x "Horizontal Scanning Time". (n=integer)
  - Frame period should be always the same.

## CONNECTOR PIN ASSIGNMENT FOR INTERFACE

### CN1 INPUT SIGNAL

Connector : DF9B-31P-1V / HIROSE ELECTRIC CO., LTD.

Mating Connector : DF9\*-31S-1V / HIROSE ELECTRIC CO., LTD. ( \* : option mark)

Terminal No.	Symbol	Function
1	GND	
2	NCLK	SAMPLING CLOCK
3	GND	
4	R0	RED DISPLAY DATA (LSB)
5	R1	RED DISPLAY DATA
6	R2	RED DISPLAY DATA
7	GND	
8	R3	RED DISPLAY DATA
9	R4	RED DISPLAY DATA
10	R5	RED DISPLAY DATA (MSB)
11	GND	
12	G0	GREEN DISPLAY DATA (LSB)
13	G1	GREEN DISPLAY DATA
14	G2	GREEN DISPLAY DATA
15	GND	
16	G3	GREEN DISPLAY DATA
17	G4	GREEN DISPLAY DATA
18	G5	GREEN DISPLAY DATA (MSB)
19	GND	
20	ENAB	COMPOUND SYNCHRONIZATION SIGNAL
21	GND	
22	B0	BLUE DISPLAY DATA (LSB)
23	B1	BLUE DISPLAY DATA
24	B2	BLUE DISPLAY DATA
25	GND	
26	B3	BLUE DISPLAY DATA
27	B4	BLUE DISPLAY DATA
28	B5	BLUE DISPLAY DATA (MSB)
29	GND	
30	V <sub>DD</sub>	+5V POWER SUPPLY
31	V <sub>DD</sub>	+5V POWER SUPPLY

### CN2 CCFL POWER SOURCE

Connector : BHR-03VS-1 / JAPAN SOLDERLESS TERMINAL MFG CO., LTD.

Mating Connector : SM02(8.0)B-BHS-1 / JAPAN SOLDERLESS TERMINAL MFG CO., LTD.

Terminal No.	Symbol	Function
1	V <sub>FLH1</sub>	CCFL Power Supply ( high voltage)
2	NC <sup>1)</sup>	Non Connection (open)
3	V <sub>FLL1</sub>	CCFL Power Supply (low voltage)

### CN3 CCFL POWER SOURCE

Connector : BHR-03VS-1 / JAPAN SOLDERLESS TERMINAL MFG CO., LTD.

Mating Connector : SM02(8.0)B-BHS-1 / JAPAN SOLDERLESS TERMINAL MFG CO., LTD.

Terminal No.	Symbol	Function
1	V <sub>FLH2</sub>	CCFL Power Supply ( high voltage)
2	NC <sup>1)</sup>	Non Connection (open)
3	V <sub>FLL2</sub>	CCFL Power Supply (low voltage)

Note 1) NC terminal should be open.

## 256k (k=1024) COLORS COMBINATION TABLE

	Display	R5 R4 R3 R2 R1 R0	G5 G4 G3 G2 G1 G0	B5 B4 B3 B2 B1 B0	Gray Scale Level
Basic Color	Black	L L L L L L	L L L L L L	L L L L L L	---
	Blue	L L L L L L	L L L L L L	H H H H H H	---
	Green	L L L L L L	H H H H H H	L L L L L L	---
	Light Blue	L L L L L L	H H H H H H	H H H H H H	---
	Red	H H H H H H	L L L L L L	L L L L L L	---
	Purple	H H H H H H	L L L L L L	H H H H H H	---
	Yellow	H H H H H H	H H H H H H	L L L L L L	---
	White	H H H H H H	H H H H H H	H H H H H H	---
Gray Scale of Red	Black	L L L L L L	L L L L L L	L L L L L L	L0
	Dark ↑ ↓ Light	L L L L L H	L L L L L L	L L L L L L	L1
		L L L L H L	L L L L L L	L L L L L L	L2
		: : :	: : :	: : :	L3... L60
		H H H H L H	L L L L L L	L L L L L L	L61
		H H H H H L	L L L L L L	L L L L L L	L62
	Red	H H H H H H	L L L L L L	L L L L L L	Red L63
	Gray Scale of Green	Black	L L L L L L	L L L L L L	L L L L L L
Dark ↑ ↓ Light		L L L L L L	L L L L L H	L L L L L L	L1
		L L L L L L	L L L L H L	L L L L L L	L2
		: : :	: : :	: : :	L3... L60
		L L L L L L	H H H H L H	L L L L L L	L61
		L L L L L L	H H H H H L	L L L L L L	L62
Green		L L L L L L	H H H H H H	L L L L L L	Green L63
Gray Scale of Blue		Black	L L L L L L	L L L L L L	L L L L L L
	Dark ↑ ↓ Light	L L L L L L	L L L L L H	L L L L L H	L1
		L L L L L L	L L L L L L	L L L L H L	L2
		: : :	: : :	: : :	L3... L60
		L L L L L L	L L L L L L	H H H H L H	L61
		L L L L L L	L L L L L L	H H H H H L	L62
	Blue	L L L L L L	L L L L L L	H H H H H H	Blue L63
	Gray Scale of White & Black	Black	L L L L L L	L L L L L L	L L L L L L
Dark ↑ ↓ Light		L L L L L H	L L L L L H	L L L L L H	L1
		L L L L H L	L L L L H L	L L L L H L	L2
		: : :	: : :	: : :	L3... L60
		H H H H L H	H H H H L H	H H H H L H	L61
		H H H H H L	H H H H H L	H H H H H L	L62
White		H H H H H H	H H H H H H	H H H H H H	White L63





LCD module is generally designed with precise parts to achieve light weighted thin mechanical dimensions.

In using our Modules, make certain that you fully understand and put into practice the warnings and safety precautions detailed in Engineering Information No.EE-N001,"CAUTIONS AND INSTRUCTIONS FOR TOSHIBA LCD MODULES".

Refer to individual specifications and TECHNICAL DATA sheets (hereinafter called "TD") for more detailed technical information.

### 1) SPECIAL PURPOSES

A) Toshiba Matsushita Display Technology's Standard LCD Modules have not been customized for operation in extreme environments or for use in applications where performance failures could be life-threatening or otherwise catastrophic.

B) Since Toshiba Matsushita Display Technology's Standard LCD Modules have not been designed for operation in extreme environments, they must never be used in devices that will be exposed to abnormally high levels of vibration or shock which exceed Toshiba Matsushita Display Technology's published specification limits.

C) In addition, since Toshiba Matsushita Display Technology Standard LCD Modules have not been designed for use in applications where performance failures could be life-threatening or catastrophic, they must never be installed in aircraft navigation control systems (such as, but not limited to Traffic Collision Avoidance System and Air Traffic Indicator), in military defense or weapons systems, in critical industrial process-control systems (e.g., those involved in the production of nuclear energy), or in critical medical device or patient life-support systems.

### 2) DISASSEMBLING OR MODIFICATION

DO NOT DISASSEMBLE OR MODIFY the module. It may damage sensitive parts inside LCD module, and may cause scratches or dust on the display.

Toshiba Matsushita Display Technology does not warrant the module, if customer disassembled or modified it.

### 3) BREAKAGE OF LCD PANEL

DO NOT INGEST liquid crystal material, DO NOT INHALE this material, and DO NOT CONTACT the material with skin, if LCD panel is broken and liquid crystal material spills out.

If liquid crystal material comes into mouth or eyes, rinse mouth or eyes out with water immediately.

If this material contact with skin or cloths, wash it off immediately with alcohol and rinse thoroughly with water.

### 4) GLASS OF LCD PANEL

BE CAREFUL WITH CHIPS OF GLASS that may cause injuring fingers or skin, when the glass is broken.

### 5) ELECTRIC SHOCK

DISCONNECT POWER SUPPLY before handling LCD module.

DO NOT TOUCH the parts inside LCD module and the fluorescent lamp's connector or cables in order to prevent electric shock, because high voltage is supplied to these parts from the inverter unit while power supply is turned on.

### 6) ABSOLUTE MAXIMUM RATINGS AND POWER PROTECTION CIRCUIT

DO NOT EXCEED the absolute maximum rating values under the worst probable conditions caused by the supply voltage variation, input voltage variation, variation in parts' constants, environmental temperature, etc., otherwise LCD module may be damaged.

Employ protection circuit for power supply, whenever the specification or TD specifies it.

Suitable protection circuit should be applied for each system design.

### 7) RECOMMENDED OPERATION CONDITIONS

The performance and quality of the LCD panel are warranted only when the LCD panel is used within "the recommended operation conditions". Toshiba Matsushita Display Technology Co., Ltd. never warrants the performance and quality of the LCD panel when you use the LCD panel over "the recommended operation conditions", although within "the absolute maximum rating".

To use the LCD panel over "the recommended operation conditions" may have bad influence on the characteristics and reliability of the LCD panel and may shorten the life of the LCD panel.

Therefore, when designing the whole set, not to be over "the recommended operation conditions", you should fully take care of supply voltage change, characteristic of connection parts, surge of input-and-output line, and surrounding temperature.

### 8) DISPOSAL

When dispose LCD module, obey to the applicable environmental regulations.