

# AVNET EMBEDDED SPECIFICATION.

## Datasheet Toshiba LTA121C33SF

All information is subject to change without notice. Please read bottom notes.

**FEATURES**

- (1) 12.1 SVGA color display with High Luminance
- (2) Built in Long Life Lamps(MTTF:60,000 h)  
( Condition/  $T_a$ :25°C,  $I_{FL}$ :6mA(rms)(continuing lighting),  $f_{FL}$ :50kHz )
- (3) Replaceable structure of lamp units and Mounting compatible with LTD121C30S series
- (4) Wide viewing angle and wide operating temperature.

**TENTATIVE****RoHS compatible****MECHANICAL SPECIFICATIONS**

Item	Specifications
Dimensional Outline (typ.)	278.3 (W) x 209.0 (H) x 11.0max (D) mm
Number of Pixels	800 (W) x 600 (H) pixels
Active Area	246.0 (W) x 184.5 (H) mm
Pixel Pitch	0.3075 (W) x 0.3075 (H)
Weight (approximately)	680g
Backlight	Sidelight ( 2 CCFLs )

**ABSOLUTE MAXIMUM RATINGS**

Item	Min.	Max.	Unit	
Supply Voltage	( $V_{DD}$ )	-0.3	4.0	V
	( $V_{FL}$ )	0	2.0	kV(rms)
FL Driving Frequency	( $f_{FL}$ )	---	100	KHz
Input Signal Voltage	( $V_{IN}$ )	-0.3	$V_{DD}+0.3$	V
Operating Temperature *1		-20	70	°C
Storage Temperature		-30	80	°C
Storage Humidity (Max. wet bulb temperature = 39°C)		10	90	%(RH)

\*1: Wet bulb temperature should be 39°C Max., and no condensation of water.

**ELECTRICAL SPECIFICATION ( $T_a=25^\circ\text{C}$ ) (RECOMMENDED OPERATION CONDITION)**

Item	Min.	Typ.	Max.	Unit	Remarks	
Supply Voltage	( $V_{DD}$ )	3.0	3.3	3.6	V	
	( $V_{FL}$ )	---	(520)	---	V(rms)	
FL Start Voltage	( $V_{SFL}$ )	1200	---	1900	V(rms)	$T_a=0^\circ\text{C}$
Differential Input Voltage	( $V_{ID}$ )	100	---	600	mV	
Common Mode Input Voltage	( $V_{CM}$ )	1.0	---	2.0	V	
Current Consumption	( $I_{DD}$ ) <sup>*3</sup>	---	210	---	mA	
	( $I_{FL}$ ) <sup>*4</sup>	4.0	---	6.5	mA(rms)	
Power Consumption <sup>*1 *2</sup>	---	(6.9)	---	W	$I_{FL}=6.0\text{mA(rms)}$	

\*2: The surface temperature caused by self heat radiation of cell itself is specified on this item.

\*3: 8 color bars pattern \*4: Except the efficiency of FL inverter

**OPTICAL SPECIFICATION ( $T_a=25^\circ\text{C}$ )**

Item	Min.	Typ.	Max.	Unit	Remarks
Contrast Ratio	(CR)	250	500	---	---
Viewing Angle (CR ≥ 10)	(Upper+Lower)	---	100	---	°
	(Left+Right)	---	120	---	°
Response Time	( $t_{ON}$ )	---	8	---	ms
	( $t_{OFF}$ )	---	17	---	ms
Luminance	(L)	320	400	---	cd/m <sup>2</sup> $I_{FL}=6.0\text{mA(rms)}$
Lamp Life Time (MTBF) <sup>*5 *6</sup>		60,000			h

\*5 : Conditions ;  $T_a=25^\circ\text{C}$ ,  $I_{FL}=6.0\text{mA(rms)}$ , continuous lighting

\*6 : Definitions of failure ; 1) Lcd luminance becomes half of the minimum value. 2) Lamp doesn't light normally.

\*The information contained herein is presented only as a guide for the applications of our products. No responsibility is assumed by Toshiba Mobile Display Co., Ltd or other rights of the third parties which may result from its use. No license is granted by implication or otherwise under any patent or patent rights of Toshiba Mobile Display Co., Ltd or others.

\*The information contained herein may be changed without prior notice. It is therefore advisable to contact Toshiba Mobile Display Co., Ltd before proceeding with the design of equipment incorporating this product.

DIMENSIONAL OUTLINE

**TENTATIVE**

Unit : mm

Standard tolerance : 0.5

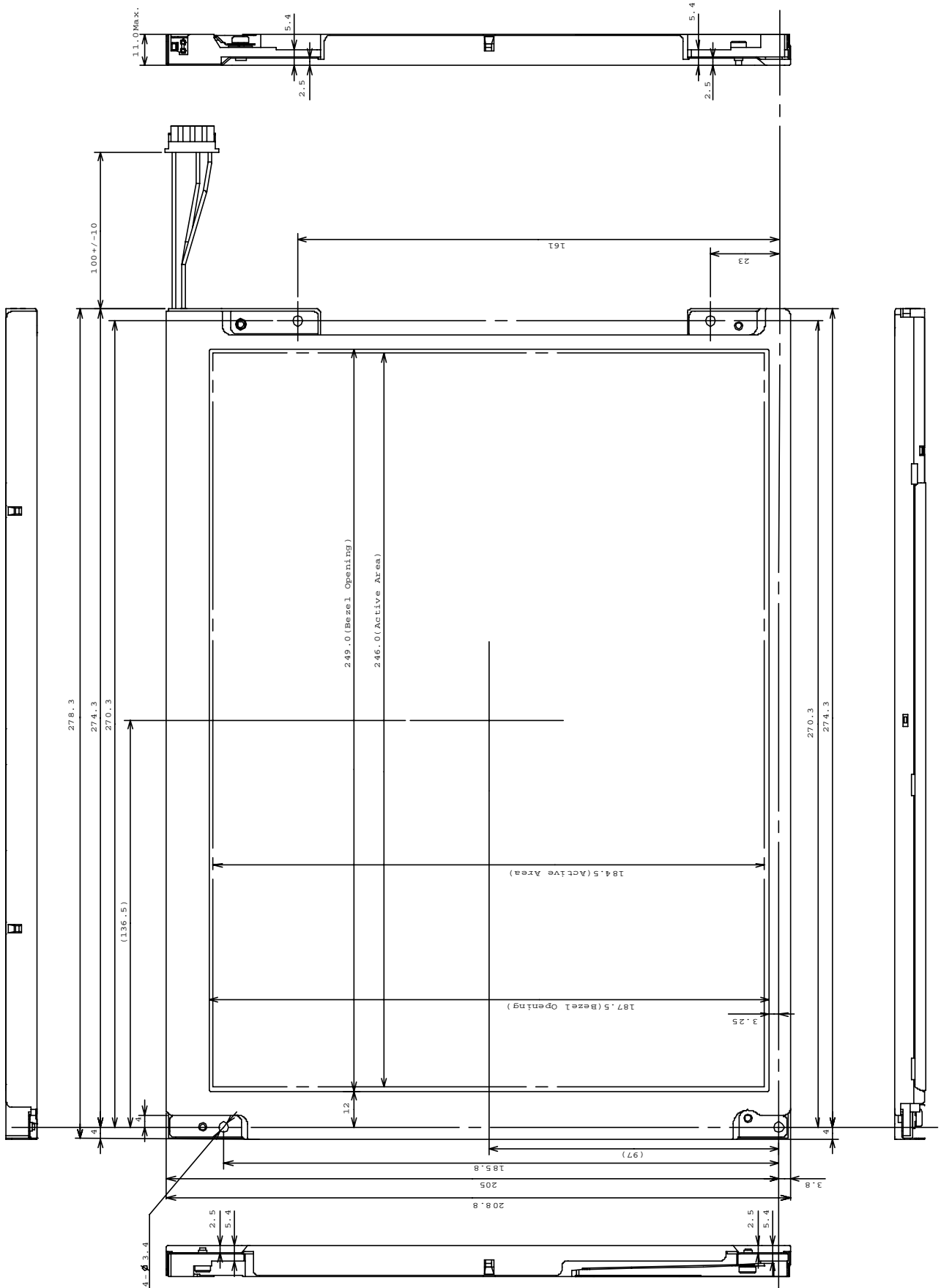

## DIMENSIONAL OUTLINE

**TENTATIVE**

Unit : mm

Standard tolerance : 0.5

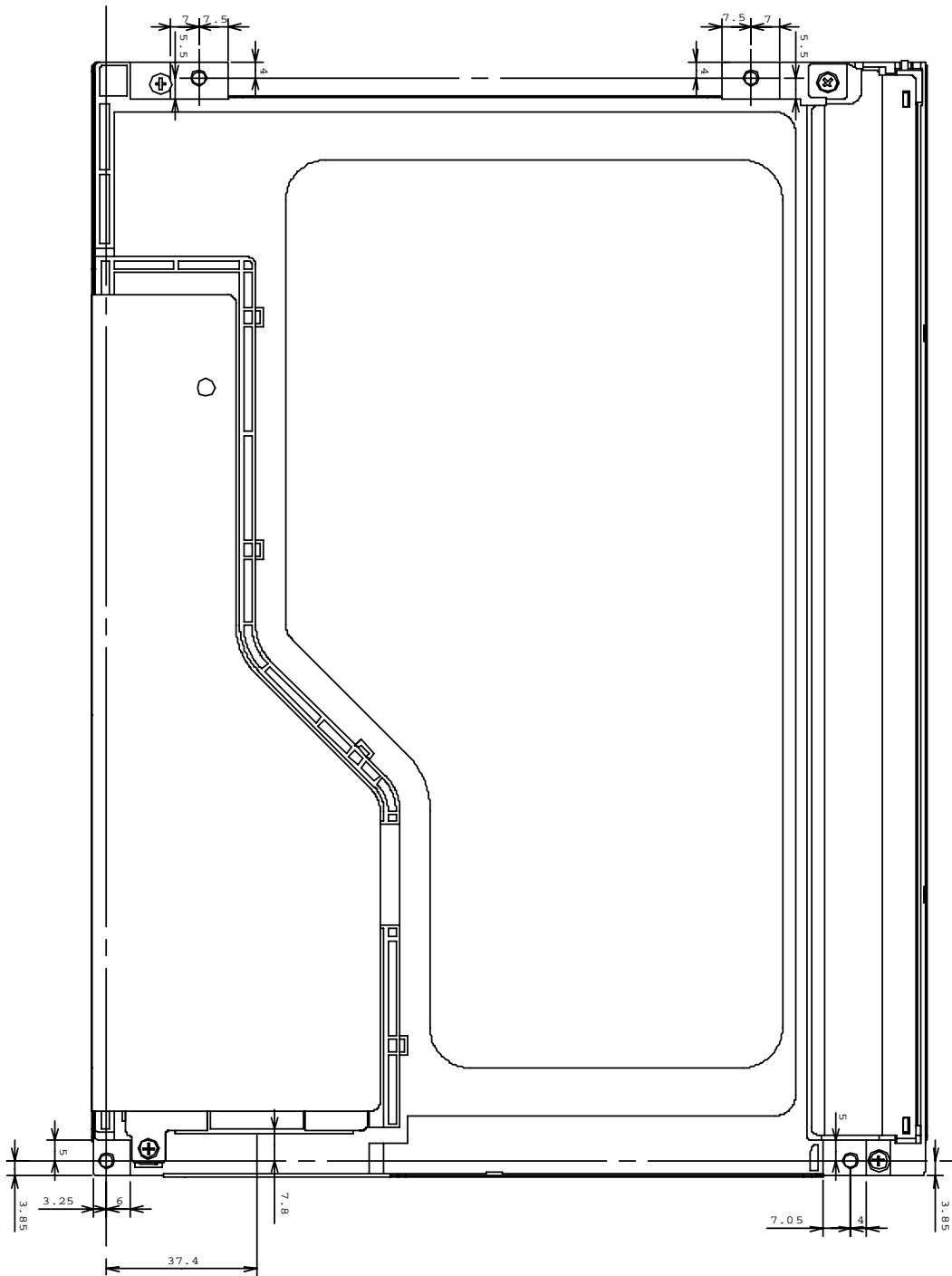

Note) The different point between LTA121C33SF and LTD121C33S is the below.

- 1) LTA121C33SF lamp unit outline is different from LTD121C33S.
- 2) LTA121C33SF Operating temperature are wider than LTD121C33S.
- 3) LTA121C33SF rear design is different from LTD121C33S.



**TIMING CHART**

<H-Sync/V-Sync+DE Mode>

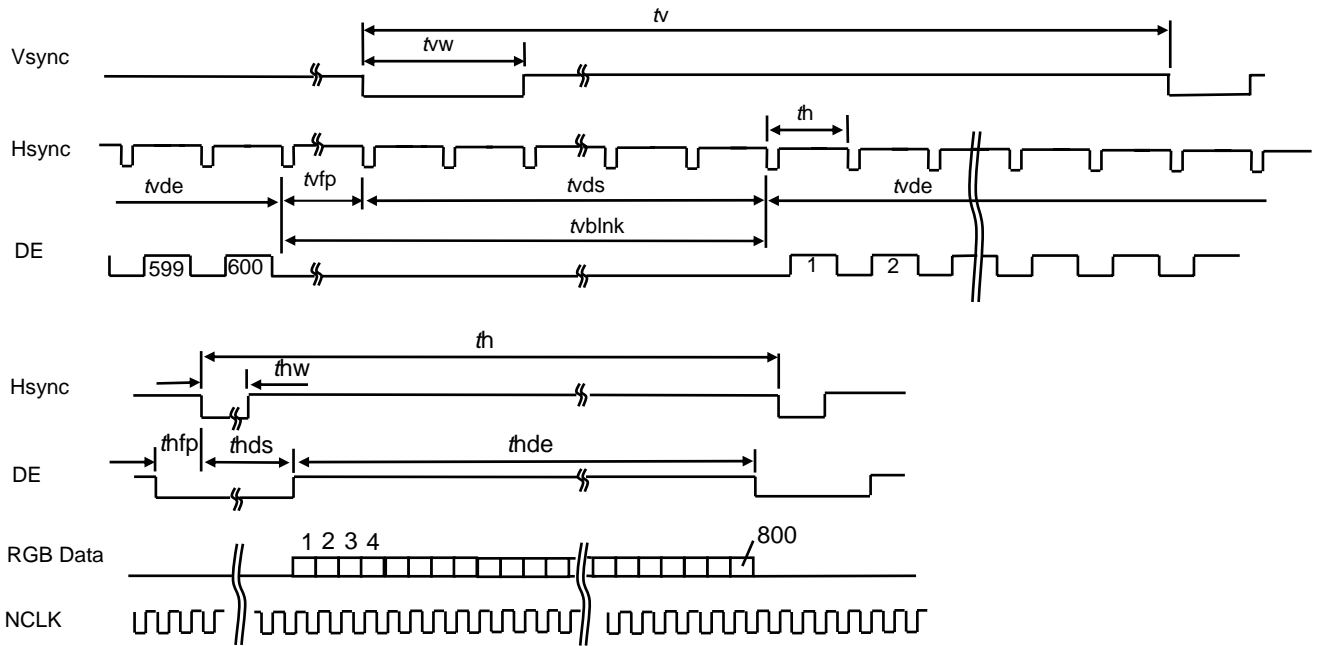

<DE-Only Mode>

(1) Vertical Timing

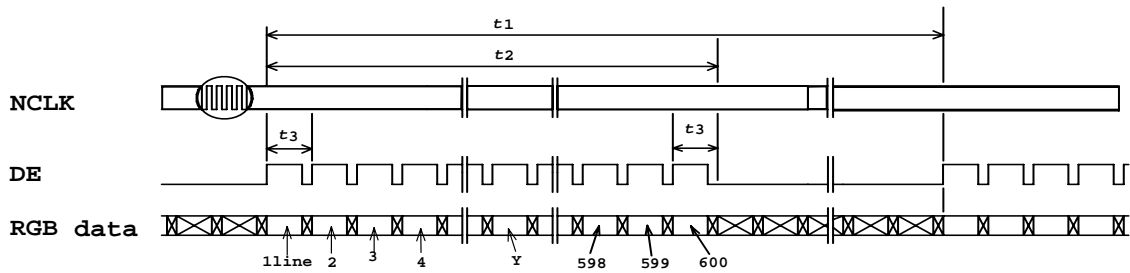

(2) Horizontal Timing

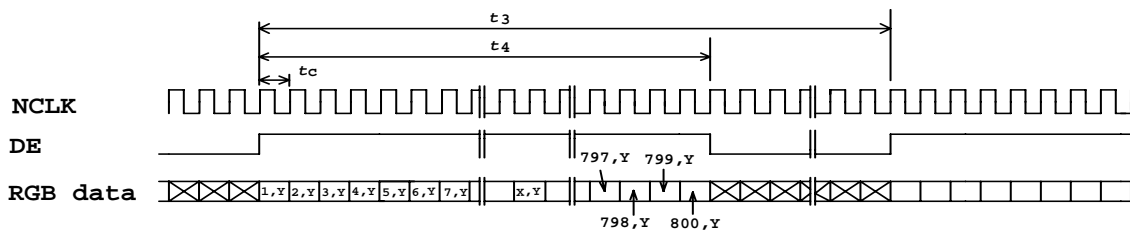

**TIMING SPECIFICATION** <sup>1) 2) 3) 4) 5) 6) 7)</sup>

## &lt;H-Sync/V-Sync+DE Mode&gt;

Item	Symbol	min.	typ.	Max.	unit
Frame Period	<i>tv</i>	608	625	628	<i>th</i>
		---	17.78	17.86	ms
Vertical blanking Term	<i>tvblnk</i>	8	25	28	<i>th</i>
V-sync Pulse Width	<i>twv</i>	2	---	---	<i>th</i>
Vertical Front Porch	<i>tvfp</i>	2	---	---	<i>th</i>
Vertical Data Sync Period	<i>tvds</i>	6	---	---	<i>th</i>
Vertical Display Term	<i>tvde</i>	600	600	600	<i>th</i>
Horizontal Period	<i>th</i>	850	1024	1056	<i>tc</i>
		26.4	28.44	---	us
H-sync Pulse Width	<i>thw</i>	8	---	---	<i>tc</i>
Horizontal Front Porch	<i>thfp</i>	8	---	---	<i>tc</i>
Horizontal Data Sync Period	<i>thds</i>	16	---	---	<i>tc</i>
Horizontal Display Term	<i>thde</i>	800	800	800	<i>tc</i>
Clock Period	<i>tc</i>	25.0	27.8	---	ns

## &lt; DE-Only Mode&gt;

Item	Symbol	Min.	Typ.	Max.	Unit
Frame Period	<i>t1</i>	608	625 x <i>t3</i>	628 x <i>t3</i>	---
		---	17.78	17.86	ms
Vertical Display Term	<i>t2</i>	600 x <i>t3</i>	600 x <i>t3</i>	600 x <i>t3</i>	---
One Line Scanning Time	<i>t3</i>	850 x <i>tc</i>	1024 x <i>tc</i>	1056 x <i>tc</i>	---
		26.4	28.44	---	us
Horizontal Display Term	<i>t4</i>	800 x <i>tc</i>	800 x <i>tc</i>	800 x <i>tc</i>	---
Clock Period	<i>tc</i>	25.0	27.78	---	ns

Note 1) Refer to "Timing Chart" and LVDS (THC63LVDF84A) specifications by THine Electronics, Inc.

Note 2) If NCLK is fixed to "H" or "L" level for certain period while DE is supplied, the panel may be damaged.

Note 3) If DE is fixed to "H" or "L" level for certain period while NCLK is supplied, the panel displays black with some flicker.

Note 4) Please adjust LCD operating signal timing and FL driving frequency, to optimize the display quality.

There is a possibility that flicker is observed by the interference of LCD operating signal timing and FL driving condition (especially driving frequency), even if the condition satisfies above timing specifications.

Note 5) Do not make *tv*, *th* and *tvds* fluctuate.

Note 6) In case of using the long frame period, the deterioration of display quality, noise etc. may be occurred.

Note 7) NCLK count of each Horizontal Scanning Time should be always the same.

V-Blanking period should be "*n*" X "Horizontal Scanning Time". (*n*: integer)

Frame period should be always the same.

## CONNECTOR PIN ASSIGNMENT FOR INTERFACE

### CN1 INPUT SIGNAL

Connector : 20268-020-12F / I-PEX CO., LTD.

Mating Connector : 20230-020B-F or 20230-T20-F or 20230-W20B-F / I-PEX CO., LTD.

DF19G-20S-1F(FPC), DF19G-20S-1C(Cable) / HIROSE ELECTRIC CO., LTD.

Terminal No.	Symbol	Function
1	VDD	Power Supply : +3.3V
2	VDD	Power Supply : +3.3V
3	VSS	GND
4	VSS	GND
5	RxIN0-	Negative LVDS differential data input (R0-R5, G0)
6	RxIN0+	Positive LVDS differential data input (R0-R5, G0)
7	VSS	GND
8	RxIN1-	Negative LVDS differential data input (G1-G5, B0-B1)
9	RxIN1+	Positive LVDS differential data input (G1-G5, B0-B1)
10	VSS	GND
11	RxIN2-	Negative LVDS differential data input (B2-B5, HS, VS, DE)
12	RxIN2+	Positive LVDS differential data input (B2-B5, HS, VS, DE)
13	VSS	GND
14	CLK-	Clock Signal(-)
15	CLK+	Clock Signal(+)
16	VSS	GND
17	U/D	Vertical Reverse("L" level or Open : Normal, "H" level : Reverse)
18	L/R	Horizontal Reverse("L" level or Open : Normal, "H" level : Reverse)
19	NC	NC
20	VSS	GND

Note 1) Please connect GND pin to ground. Don't use it as no-connect nor connection with high impedance.

### CN2 CCFL POWER SOURCE

Connector : BHR-04VS-1 / JAPAN SOLDERLESS TERMINAL MFG CO., LTD.

Mating Connector<sup>3)</sup> : SM04(4.0)B-BHS-1 / JAPAN SOLDERLESS TERMINAL MFG CO., LTD.

Terminal No.	Symbol	Function
1	VFLH1	CCFL Power Supply ( high voltage)
2	VFLH2	CCFL Power Supply ( high voltage)
3	NC <sup>2)</sup>	Non Connection (open)
4	VFLL	CCFL Power Supply (low voltage)

Note 2) NC terminal should be open.

Note 3) Take away terminal No.3 of the mating connector. If does not take away, it may cause smoke burn of electrical parts by high voltage.



**RECOMMENDED TRANSMITTER (THC63LVDF63A, THC63LVDM63A by Thine Electronics, Inc.)  
TO LTA121C33SF INTERFACE ASSIGNMENT**

**Case1: 6bit Transmitter**

THC63LVDF63A, THC63LVDM63A				LTA121C33SF Interface (CN1)		
Input Terminal No.		Input Signal (Graphics controller output signal)		Output Signal Symbol		
Symbol	Terminal	Symbol	Function		Terminal	Symbol
TA0	44	R0	Red Pixels Display Data (LSB)	TA- TA+	No.5 No.6	RxIN0- RxIN0+
TA1	45	R1	Red Pixels Display Data			
TA2	47	R2	Red Pixels Display Data			
TA3	48	R3	Red Pixels Display Data			
TA4	1	R4	Red Pixels Display Data			
TA5	3	R5	Red Pixels Display Data (MSB)			
TA6	4	G0	Green Pixels Display Data (LSB)	TB- TB+	No.8 No.9	RxIN1- RxIN1+
TB0	6	G1	Green Pixels Display Data			
TB1	7	G2	Green Pixels Display Data			
TB2	9	G3	Green Pixels Display Data			
TB3	10	G4	Green Pixels Display Data			
TB4	12	G5	Green Pixels Display Data (MSB)			
TB5	13	B0	Blue Pixels Display Data (LSB)	TC- TC+	No.11 No.12	RxIN2- RxIN2+
TB6	15	B1	Blue Pixels Display Data			
TC0	16	B2	Blue Pixels Display Data			
TC1	18	B3	Blue Pixels Display Data			
TC2	19	B4	Blue Pixels Display Data			
TC3	20	B5	Blue Pixels Display Data (MSB)			
TC4	22	HSYNC	H-Sync	TCLK- TCLK+	No.14 No.15	CLK- CLK+
TC5	23	VSYNC	V-Sync			
TC6	25	DE	Compound Synchronization Signal			
CLK IN	26	NCLK	Data Sampling Clock			

Note 1) Please connect NC pin to nothing. Don't connect it to ground nor to other signal input.

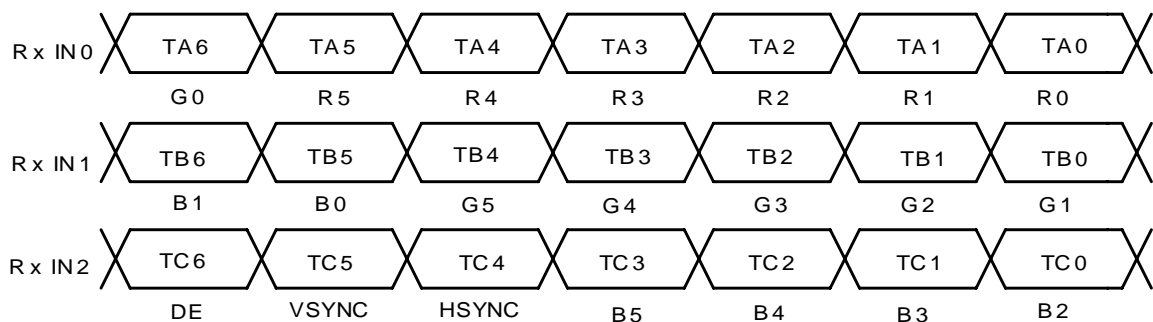

**RECOMMENDED TRANSMITTER (THC63LVDM83D, THC63LVDM83R by THine Electronics, Inc.)  
TO LTA121C33SF INTERFACE ASSIGNMENT**

**Case2: 8bit Transmitter**

THC63LVDM83D,THC63LVDM83R				LTA121C33SF Interface (CN1)		
Input Terminal No.		Input Signal (Graphics controller output signal)		Output Signal Symbol		
Symbol	Terminal	Symbol	Function		Terminal	Symbol
TA0	51	R0	Red Pixels Display Data (LSB)	TA- TA+	No.5 No.6	RxIN0- RxIN0+
TA1	52	R1	Red Pixels Display Data			
TA2	54	R2	Red Pixels Display Data			
TA3	55	R3	Red Pixels Display Data			
TA4	56	R4	Red Pixels Display Data			
TA5	3	R5	Red Pixels Display Data (MSB)			
TA6	4	G0	Green Pixels Display Data(LSB)	TB- TB+	No.8 No.9	RxIN1- RxIN1+
TB0	6	G1	Green Pixels Display Data			
TB1	7	G2	Green Pixels Display Data			
TB2	11	G3	Green Pixels Display Data			
TB3	12	G4	Green Pixels Display Data			
TB4	14	G5	Green Pixels Display Data(MSB)			
TB5	15	B0	Blue Pixels Display Data (LSB)	TC- TC+	No.11 No.12	RxIN2- RxIN2+
TB6	19	B1	Blue Pixels Display Data			
TC0	20	B2	Blue Pixels Display Data			
TC1	22	B3	Blue Pixels Display Data			
TC2	23	B4	Blue Pixels Display Data			
TC3	24	B5	Blue Pixels Display Data (MSB)			
TC4	27	HSYNC	H-Sync	TD- TD+		
TC5	28	VSYNC	V-Sync			
TC6	30	DE	Compound Synchronization Signal			
TD0	50	NC <sup>*1</sup>	Non Connection (open)			
TD1	2	NC <sup>*1</sup>	Non Connection (open)	TCLK- TCLK+	No.14 No.15	CLK- CLK+
TD2	8	NC <sup>*1</sup>	Non Connection (open)			
TD3	10	NC <sup>*1</sup>	Non Connection (open)			
TD4	16	NC <sup>*1</sup>	Non Connection (open)			
TD5	18	NC <sup>*1</sup>	Non Connection (open)			
TD6	25	NC <sup>*1</sup>	Non Connection (open)			
CLK IN	31	NCLK	Data Sampling Clock			

Note 1) Please connect NC pin to nothing. Don't connect it to ground nor to other signal input.

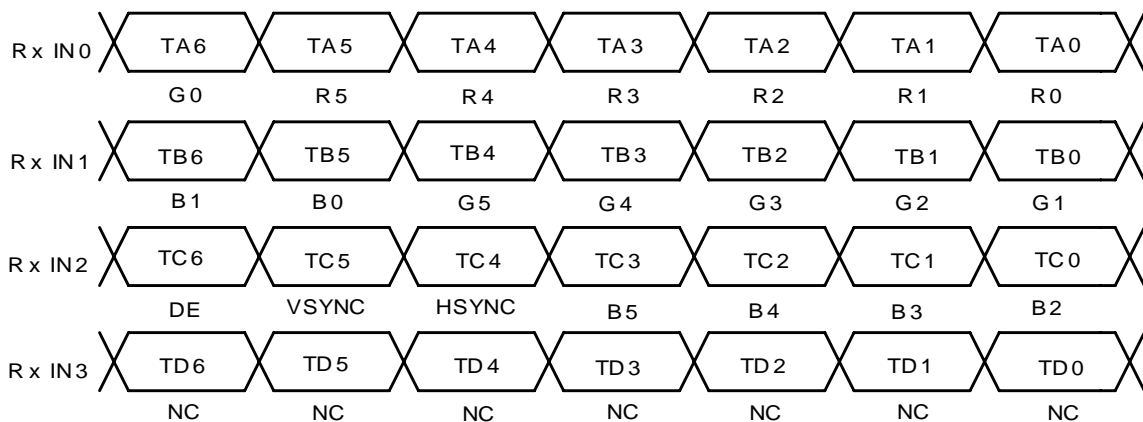

256k (k=1024) COLORS COMBINATION TABLE

	Display	R5 R4 R3 R2 R1 R0	G5 G4 G3 G2 G1 G0	B5 B4 B3 B2 B1 B0	Gray Scale Level
Basic Color	Black	L L L L L L	L L L L L L	L L L L L L	---
	Blue	L L L L L L	L L L L L L	H H H H H H	---
	Green	L L L L L L	H H H H H H	L L L L L L	---
	Light Blue	L L L L L L	H H H H H H	H H H H H H	---
	Red	H H H H H H	L L L L L L	L L L L L L	---
	Purple	H H H H H H	L L L L L L	H H H H H H	---
	Yellow	H H H H H H	H H H H H H	L L L L L L	---
	White	H H H H H H	H H H H H H	H H H H H H	---
Gray Scale of Red	Black	L L L L L L	L L L L L L	L L L L L L	L 0
	Dark ↑ ↓ Light	L L L L L H	L L L L L L	L L L L L L	L 1
		L L L L H L	L L L L L L	L L L L L L	L 2
		: :	:	:	L3...
		: :	:	:	L60
		H H H H L H	L L L L L L	L L L L L L	L61
	H H H H H L	L L L L L L	L L L L L L	L62	
Red	H H H H H H	L L L L L L	L L L L L L	Red L63	
Gray Scale of Green	Black	L L L L L L	L L L L L L	L L L L L L	L 0
	Dark ↑ ↓ Light	L L L L L L	L L L L L H	L L L L L L	L 1
		L L L L L L	L L L L H L	L L L L L L	L 2
		: :	:	:	L3...
		: :	:	:	L60
		L L L L L L	H H H H L H	L L L L L L	L61
	L L L L L L	H H H H H L	L L L L L L	L62	
Green	L L L L L L	H H H H H H	L L L L L L	Green L63	
Gray Scale of Blue	Black	L L L L L L	L L L L L L	L L L L L L	L 0
	Dark ↑ ↓ Light	L L L L L L	L L L L L L	L L L L L H	L 1
		L L L L L L	L L L L L L	L L L L H L	L 2
		: :	:	:	L3...
		: :	:	:	L60
		L L L L L L	L L L L L L	H H H H L H	L61
	L L L L L L	L L L L L L	H H H H H L	L62	
Blue	L L L L L L	L L L L L L	H H H H H H	Blue L63	
Gray Scale of White & Black	Black	L L L L L L	L L L L L L	L L L L L L	L 0
	Dark ↑ ↓ Light	L L L L L H	L L L L L H	L L L L L H	L 1
		L L L L H L	L L L L H L	L L L L H L	L 2
		: :	:	:	L3...
		: :	:	:	L60
		H H H H L H	H H H H L H	H H H H L H	L61
	H H H H H L	H H H H H L	H H H H H L	L62	
White	H H H H H H	H H H H H H	H H H H H H	White L63	

**FOR SAFETY**

LCD module is generally designed with precise parts to achieve light weighted thin mechanical dimensions.

In using our Modules, make certain that you fully understand and put into practice the warnings and safety precautions detailed in Engineering Information No.EE-N001,"CAUTIONS AND INSTRUCTIONS FOR TOSHIBA LCD MODULES".

Refer to individual specifications and TECHNICAL DATA sheets (hereinafter called "TD") for more detailed technical information.

**1) SPECIAL PURPOSES**

A) Toshiba Mobile Display Co., Ltd 's Standard LCD Modules have not been customized for operation in extreme environments or for use in applications where performance failures could be life-threatening or otherwise catastrophic.

B) Since Toshiba Mobile Display Co., Ltd 's Standard LCD Modules have not been designed for operation in extreme environments, they must never be used in devices that will be exposed to abnormally high levels of vibration or shock which exceed Toshiba Mobile Display Co., Ltd 's published specification limits.

C) In addition, since Toshiba Mobile Display Co., Ltd Standard LCD Modules have not been designed for use in applications where performance failures could be life-threatening or catastrophic, they must never be installed in aircraft navigation control systems (such as, but not limited to Traffic Collision Avoidance System and Air Traffic Indicator), in military defense or weapons systems, in critical industrial process-control systems (e.g., those involved in the production of nuclear energy), or in critical medical device or patient life-support systems.

**2) DISASSEMBLING OR MODIFICATION**

DO NOT DISASSEMBLE OR MODIFY the module. It may damage sensitive parts inside LCD module, and may cause scratches or dust on the display.

Toshiba Mobile Display Co., Ltd does not warrant the module, if customer disassembled or modified it.

**3) BREAKAGE OF LCD PANEL**

DO NOT INGEST liquid crystal material, DO NOT INHALE this material, and DO NOT CONTACT the material with skin, if LCD panel is broken and liquid crystal material spills out.

If liquid crystal material comes into mouth or eyes, rinse mouth or eyes out with water immediately.

If this material contact with skin or cloths, wash it off immediately with alcohol and rinse thoroughly with water.

**4) GLASS OF LCD PANEL**

BE CAREFUL WITH CHIPS OF GLASS that may cause injuring fingers or skin, when the glass is broken.

**5) ELECTRIC SHOCK**

DISCONNECT POWER SUPPLY before handling LCD module.

DO NOT TOUCH the parts inside LCD module and the fluorescent lamp's connector or cables in order to prevent electric shock, because high voltage is supplied to these parts from the inverter unit while power supply is turned on.

**6) ABSOLUTE MAXIMUM RATINGS AND POWER PROTECTION CIRCUIT**

DO NOT EXCEED the absolute maximum rating values under the worst probable conditions caused by the supply voltage variation, input voltage variation, variation in parts' constants, environmental temperature, etc., otherwise LCD module may be damaged.

Employ protection circuit for power supply, whenever the specification or TD specifies it.

Suitable protection circuit should be applied for each system design.

**7) RECOMMENDED OPERATION CONDITIONS**

The performance and quality of the LCD panel are warranted only when the LCD panel is used within "the recommended operation conditions". Toshiba Mobile Display Co., Ltd. never warrants the performance and quality of the LCD panel when you use the LCD panel over "the recommended operation conditions", although within "the absolute maximum rating".

To use the LCD panel over "the recommended operation conditions" may have bad influence on the characteristics and reliability of the LCD panel and may shorten the life of the LCD panel.

Therefore, when designing the whole set, not to be over "the recommended operation conditions", you should fully take care of supply voltage change, characteristic of connection parts, surge of input-and-output line, and surrounding temperature.

**8) DISPOSAL**

When dispose LCD module, obey to the applicable environmental regulations.

## AVNET EMBEDDED OFFICES.

### DENMARK

Trident  
Avnet Nortec A/S  
Banemarksvej 50B, 1  
2605 Broendby  
Phone: +45 3678 6250  
Fax: +45 3678 6255  
trident-denmark@avnet-embedded.eu

### FINLAND

Trident  
Avnet Nortec Oy  
Tiilenpolttajankuja 3 A B  
1720 Vantaa  
Phone: +358 207 499260  
Fax: +358 942 597446  
trident-finland@avnet-embedded.eu

### FRANCE

Axess Technology  
Avnet EMG France SA  
Immeuble 154, Parc Chene 2  
5, allée du General Benoist  
69000 Bron  
Phone: +33 4 72 81 02 30  
Fax: +33 4 72 81 02 34  
axess-bron@avnet-embedded.eu

Axess Technology  
Avnet EMG France SA  
4, rue de la Couture  
Bâtiment Milan, BP 20209  
94518 Rungis Cedex  
Phone: +33 1 49 78 88 88  
Fax: +33 1 49 78 88 89  
axess-rungis@avnet-embedded.eu

Axess Technology  
Avnet EMG France SA  
ZA la Hallerais le Semiramis  
35770 Vern sur Seiche  
Phone: +33 2 99 77 37 02  
Fax: +33 2 99 77 33 38  
axess-rennes@avnet-embedded.eu

### GERMANY (AUSTRIA, CZECH REPUBLIC, HUNGARY, POLAND, SWITZERLAND)

Avnet Embedded  
Avnet EMG GmbH  
Gruber Straße 60c  
85586 Poing  
Phone: +49 8121 775 500  
Fax: +49 8121 775 550  
poing@avnet-embedded.eu

Avnet Embedded  
Avnet EMG GmbH  
Lötscher Weg 66  
41334 Nettetal  
Phone: +49 8121 775 500  
Fax: +49 8121 775 550  
nettetal@avnet-embedded.eu

### ITALY

Avnet Embedded  
Avnet EMG Italy SRL  
Via Manzoni, 44  
20095 Cusano Milanino  
Phone: +39 02 66092 1  
Fax: +39 02 66092 498  
milano@avnet-embedded.eu

### NETHERLANDS (BELGIUM, LUXEMBOURG)

Avnet Embedded  
Avnet B.V.  
Takkebijsters 2  
4802 BL Breda  
Phone: +31 76 5722400  
Fax: +31 76 5722404  
benelux@avnet-embedded.eu

### SPAIN

Avnet Embedded  
Avnet Iberia SA  
C/Chile, 10 - Edificio Madrid 92  
28290 Las Matas (Madrid)  
Phone: +34 91 372 7142  
Fax: +34 91 636 9788  
madrid@avnet-embedded.eu

### SWEDEN (NORWAY)

Trident  
Avnet Nortec AB  
Esplanaden 3 D  
172 67 Sundbyberg  
Phone: +46 8 564 725 50  
Fax: +46 8 760 01 10  
trident-sweden@avnet-embedded.eu

### UNITED KINGDOM (IRELAND)

TDC  
Avnet EMG Ltd.  
Pilgrims Court, 15/17 West Street  
Reigate, Surrey, RH2 9BL  
Phone: +44 1737 227888  
Fax: +44 1737 243872  
tdc@avnet-embedded.eu

Trident  
Avnet EMG Ltd.  
Pilgrims Court, 15/17 West Street  
Reigate, Surrey, RH2 9BL  
Phone: +44 1737 227800  
Fax: +44 1737 244698  
trident-uk@avnet-embedded.eu

All trademarks and logos are the property of their respective owners. This document provides a brief overview only and is not intended to be complete or binding offer. Product information, including information related to a product's specifications, uses or conformance with legal or other requirements, is obtained by Avnet from its suppliers or other sources deemed reliable and is provided by Avnet on an „As Is“ basis. Avnet makes no representation as to the accuracy or completeness of the product information and Avnet disclaims all representations, warranties and liabilities under any theory with respect to the product information, including any implied warranties of merchantability, fitness for a particular purpose, title and/or non-refrangement. All product information is subject to change without notice.

### LOCAL AVNET EMBEDDED BUSINESSES:

**axess**  
technology

An Avnet Embedded Business

**tdc**

An Avnet Embedded Business

**trident**

An Avnet Embedded Business