

Customer : General

DATE : Jan. 07. 2011

SAMSUNG TFT-LCD

MODEL : LTA320AN01-W

The Information Described in this Specification is Preliminary and can be changed without prior notice

NOTE :

Samsung Electronics Co . , LTD.

Revision History ----- (3)

General Description ----- (4)

General Information ----- (4)

1. Absolute Maximum Ratings ----- (5)

2. Optical Characteristics ----- (6)

3. Electrical Characteristics ----- (9)

 3.1 TFT LCD Module

 3.2 Back Light Unit

4. Block Diagram ----- (11)

5. Input Terminal Pin Assignment ----- (12)

 5.1 Input Signal & Power

 5.2 Inverter Input Pin Configuration

 5.3 Inverter Input Power Sequence & Specification

 5.4 LVDS Interface

 5.5 Input Signals, Basic Display Colors and Gray Scale of Each Color

6. Interface Timing ----- (18)

 6.1 Timing Parameters (DE only mode)

 6.2 Timing Diagrams of interface Signal (DE only mode)

 6.3 Power ON/OFF Sequence

7. Outline Dimension ----- (21)

8. Packing ----- (23)

9. Marking & Others ----- (24)

10. General Precaution ----- (25)

 10.1 Handling

 10.2 Storage

 10.3 Operation

 10.4 Operation Condition Guide

 10.5 Others

*** Revision History**

Date	Rev. No	Page	Summary
Jan. 07 2011	000	-	First Issued

Description

LTA320AN01 is a color active matrix liquid crystal display (LCD) that uses amorphous silicon TFT (Thin Film Transistor) as switching components. This model is composed of a TFT LCD panel, a driver circuit and a back light unit. The resolution of a 32.0" is 1366 x 768 and this model can display up to 16.7 million colors with wide viewing angle of 89° or higher in all directions. This panel is intended to support applications to provide an excellent performance for Flat Panel Display such as Home-alone Multimedia TFT-LCD TV, Display terminals for AV application products, and High Definition TV (HDTV).

Features

- RoHS compliance (Pb-free)
- High contrast ratio, high aperture ratio, fast response time
- PVA mode
- Wide viewing angle ($\pm 89^\circ$)
- WXGA (1366 x 768 pixels) resolution (16:9)
- Low Power consumption
- 4 CCFTs (Cold Cathode Fluorescent Tube)
- LVDS (Low Voltage Differential Signaling) interface

General Information

Items	Specification	Unit	Note
Module Size	760(H _{TYP}) x 450(V _{TYP})	mm	±1.0mm
	56.7(D _{MAX})		
Weight	5600(Max)	g	
Pixel Pitch	0.51075(H) x 0.17025(V) * 3	mm	
Active Display Area	697.6845(H) x 392.256(V)	mm	
Surface Treatment	Haze 5.5%, Hard-coating (3H)		
Display Colors	8 bit- 16.7M	colors	
Number of Pixels	1366 x 768	pixel	
Pixel Arrangement	RGB Horizontal stripe		
Display Mode	Normally Black		
Luminance of White	450	cd/m ²	Typ.

1. Absolute Maximum Ratings

If the condition exceeds maximum ratings, it can cause malfunction or unrecoverable damage to the device.

Item	Symbol	Min.	Max.	Unit	Note
Power Supply Voltage	V_{DD}	VDD-1	13	V	(1)
Storage temperature	T_{STG}	-20	65	°C	(2)
Operating Temperature	T_{OPR}	0	50	°C	(2)
Panel surface temperature	T_{SUR}	0	65	°C	(3)
Shock (non - operating)	S_{NOP}	-	50	G	(4)
Vibration (non - operating)	V_{NOP}	-	1.5	G	(5)

Note (1) $T_a = 25 \pm 2 \text{ }^\circ\text{C}$

(2) Temperature and relative humidity range are shown in the figure below.

a. 93.8 % RH Max. ($T_a \leq 40 \text{ }^\circ\text{C}$)

b. Maximum wet-bulb temperature at $40 \text{ }^\circ\text{C}$ or less. ($T_a \leq 40 \text{ }^\circ\text{C}$)

c. No condensation

(3) Polarizer will not be damaged in this range, even though abnormal visual problems occur in T_{SUR} range.

(4) 11ms, sine wave, one time for $\pm X, \pm Y, \pm Z$ axis

(5) 10-300 Hz, Sweep rate 10min, 30min for X,Y,Z axis

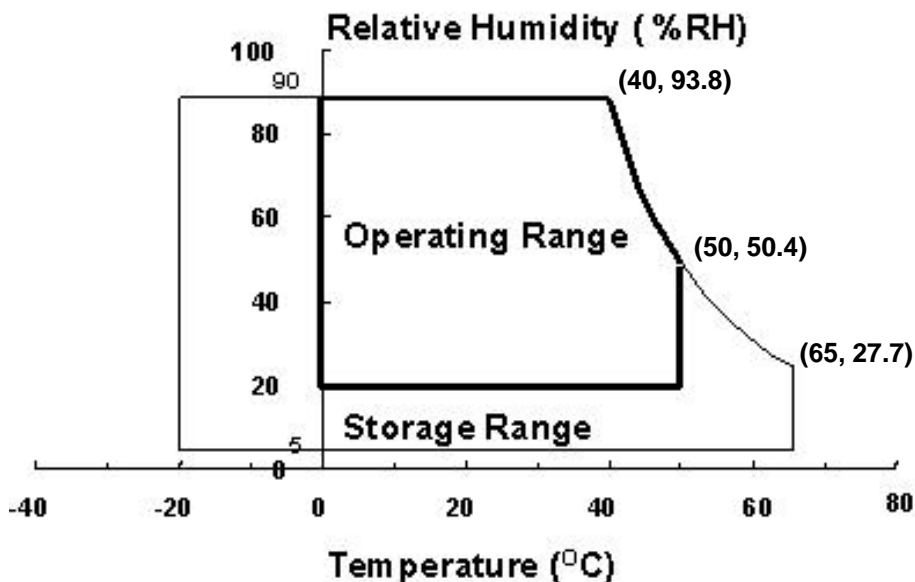

Fig. Temperature and Relative humidity range

2. Optical Characteristics

Samsung Secret

The optical characteristics should be measured in a dark room or equivalent.

Measuring equipment : TOPCON BM-7, SPECTRORADIOMETER SR-3

($T_a = 25 \pm 2^\circ\text{C}$, $V_{DD}=12\text{V}$, $f_v=60\text{Hz}$, $f_{DCLK}=148.5\text{MHz}$, $\text{Dim} = 100\%$)

Item	Symbol	Condition	Min.	Typ.	Max.	Unit	Note	
Contrast Ratio (Center of screen)	C/R	Normal $\theta_{L,R}=0$ $\theta_{U,D}=0$	*2500	5000	-		(3) SR-3A	
Response Time	Rising		Tr	-	15	70	msec	(5) RD-80S
	Falling		Tf	-	8	18		
	G-to-G [AVE]		Tg	-	20	-		
Luminance of White (Center of screen)	Y_L		380	450	-	cd/m ²	(6) SR-3A	
Color Chromaticity (CIE 1931)	Red	Rx	Viewing Angle	TYP. -0.03	TYP. +0.03		(7),(8) SR-3A	
		Ry						
	Green	Gx						
		Gy						
	Blue	Bx						
		By						
	White	Wx						
		Wy						
Color Gamut	-		-	72	-	%	(7) SR-3A	
Color Temperature	-		-	10000	-	K	(7) SR-3A	
Gamma	γ		-	2.2	-			
Viewing Angle	Hor.	θ_L	C/R \geq 10	79	89	-	Degree	(8) EZ-Contrast
		θ_R						
	Ver.	θ_U						
		θ_D						
Brightness Uniformity (9 Points)	B_{uni}		-	-	25	%	(4) SR-3	

* marked Items Value does not Specification above when "White stain" occurs at Center Point [Point ⑤ of Note 2.]

Note (1) Test Equipment Setup

The measurement should be executed in a stable, windless and dark room between 40min and 60min after lighting the back light at the given temperature for stabilization of the back light. This should be measured in the center of screen.

Single lamp current @ $V_{dim} = 100\%$

Environment condition : $T_a = 25 \pm 2^\circ\text{C}$

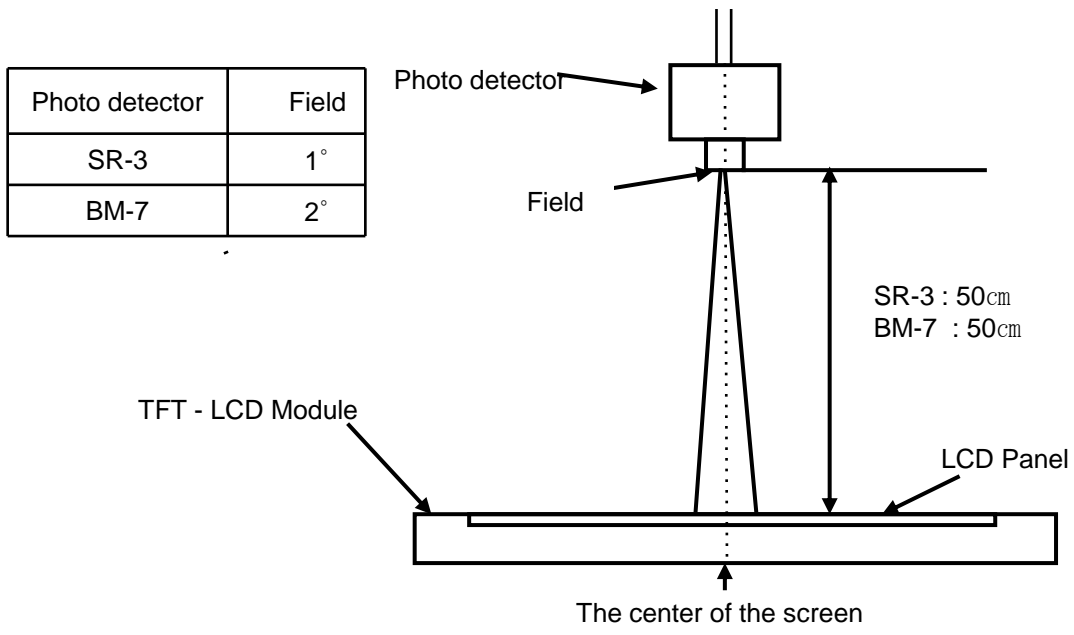

Note (2) Definition of test point

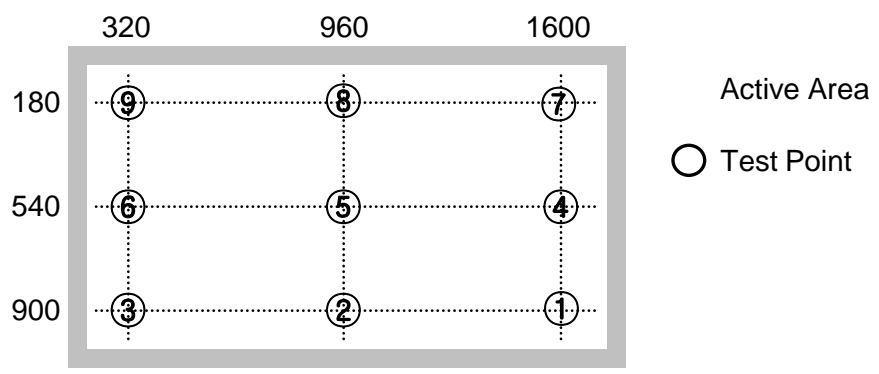

Note (3) Definition of Contrast Ratio (C/R)

: Ratio of gray max (Gmax) & gray min (Gmin) at the center point ⑤ of the panel

$$C/R = \frac{G_{max}}{G_{min}}$$

Gmax : Luminance with all pixels white
 Gmin : Luminance with all pixels black

Note (4) Definition of 9 points brightness uniformity

$$B_{uni} = 100 * \frac{(B_{max} - B_{min})}{B_{max}}$$

B_{max} : Maximum brightness
 B_{min} : Minimum brightness

Note (5) Definition of Response time : Sum of Tr, Tf

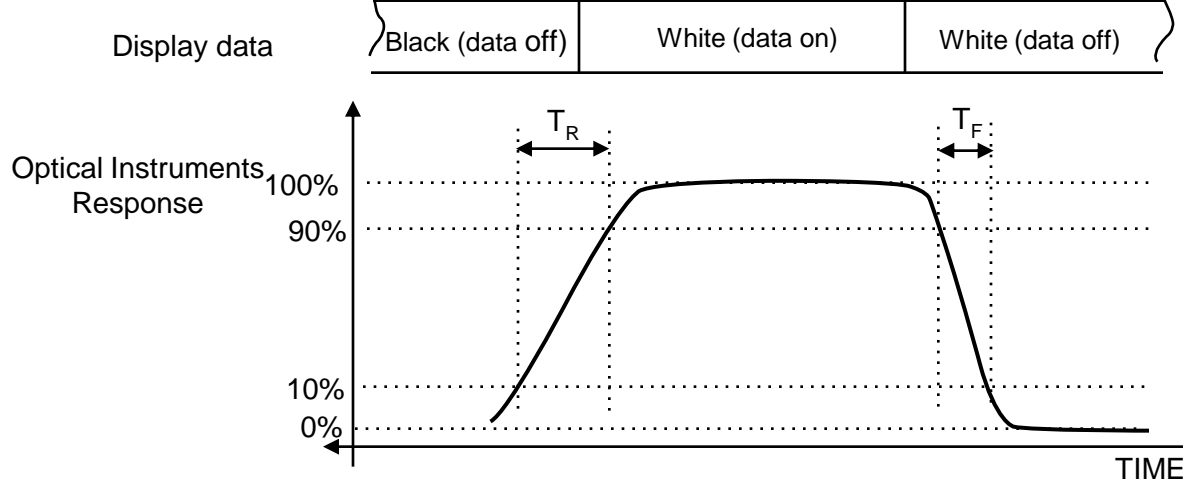

Note (6) Definition of Luminance of White : Luminance of white at center point ⑤

Note (7) Definition of Color Chromaticity (CIE 1931)
 Color coordinate of Red, Green, Blue & White at center point ⑤

Note (8) Definition of Viewing Angle
 : Viewing angle range (C/R ≥ 10)

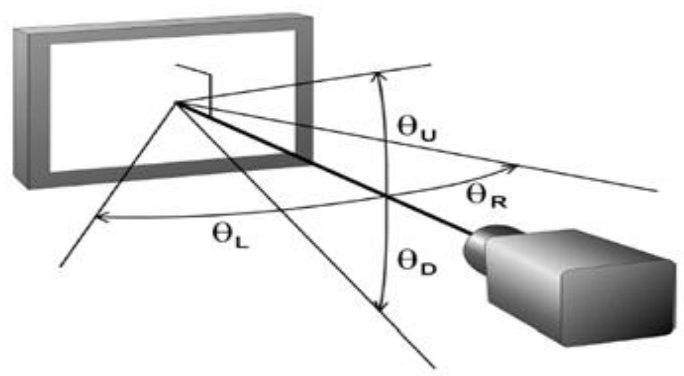

3. Electrical Characteristics

3.1 TFT LCD Module

The connector for display data & timing signal should be connected.

Ta = 25°C ± 2 °C

Item	Symbol	Min.	Typ.	Max.	Unit	Note
Voltage of Power Supply	V _{DD}	11	12	13	V	(1)
Current of Power Supply	(a) Black	-	354	-	mA	(2),(3)
	(b) White	-	366	500		
	(c) Mosaic	-	361	-		
	(4) Max Pattern (V-Stripe)	-	556	700		
Vsync Frequency	f _V	47	60	63	Hz	
Hsync Frequency	f _H	45	48.6	53	kHz	
Main Frequency	f _{DCLK}	65	80	86	MHz	
Rush Current	I _{RUSH}	-	-	5	A	(4)

Note (1) The ripple voltage should be controlled under 10% of V_{DD}.

(2) f_v=60Hz, f_{dCLK} = 148.5MHz, V_{DD} = 12.0V, DC Current.

(3) Power dissipation check pattern (LCD Module only)

a) Black Pattern



b) White Pattern



c) Mosaic

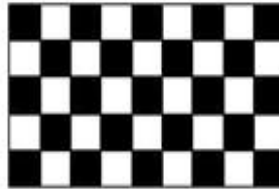

d) Max. Pattern(V-Stripe)

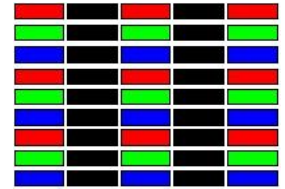

(4) Measurement Conditions

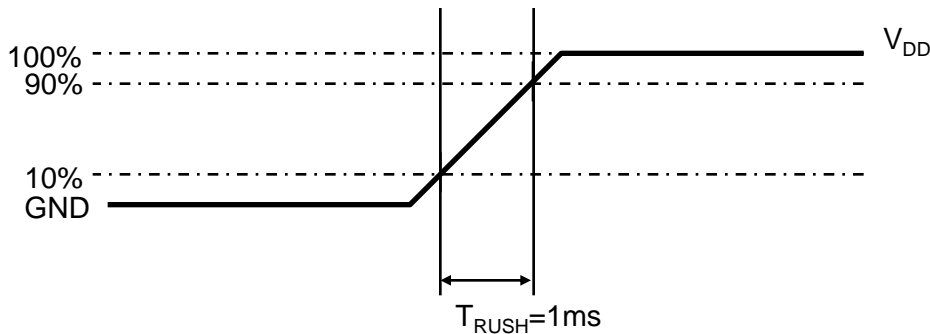

Rush Current I_{RUSH} can be measured when T_{RUSH} is 1ms

3.2 Back Light Unit

The back light unit contains 4 CCFTs (Cold Cathode Fluorescent Tube).
 The characteristics of lamps are shown in the following tables.

Ta=25 ± 2°C

Item	Symbol	Min.	Typ.	Max.	Unit	Note
Operating Life Time	Hr	50,000	-	-	Hour	(1)
Lamp Current	Lc	9.0	-	14.5	mA	-

Note (1) It is defined as the time to take until the brightness reduces to 50% of its original value.

[Operating condition : Ta = 25±2°C, I_L = 14 mArms(typ.), For single lamp only.]

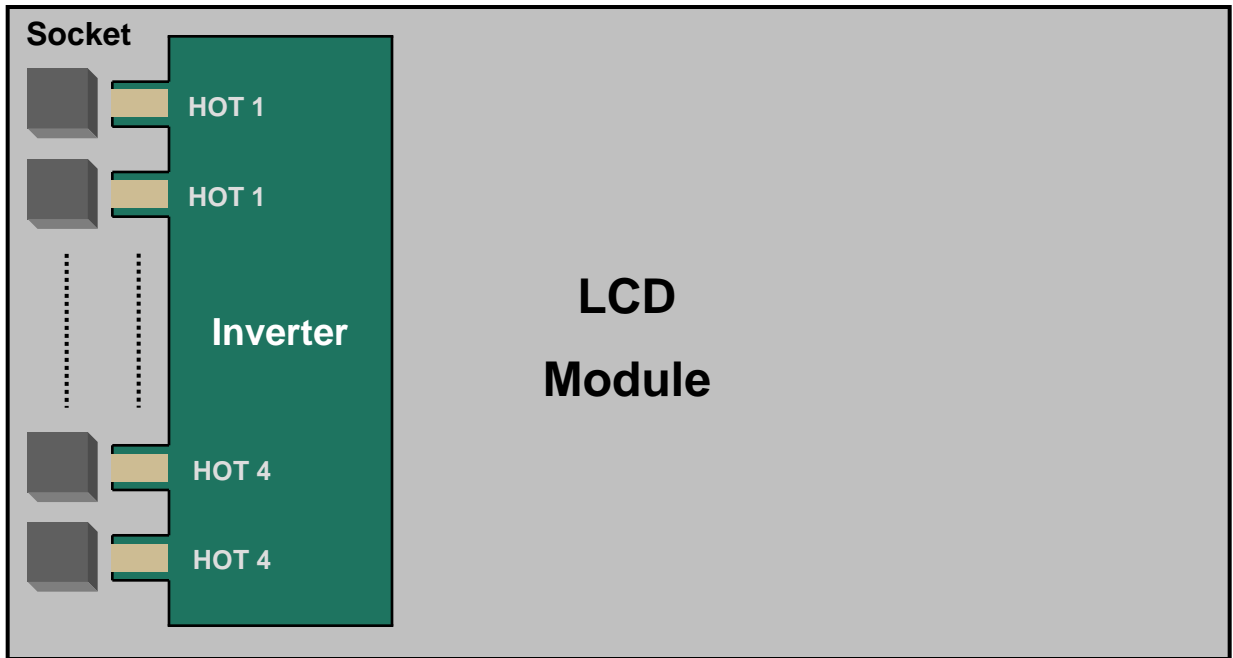

4. Block Diagram

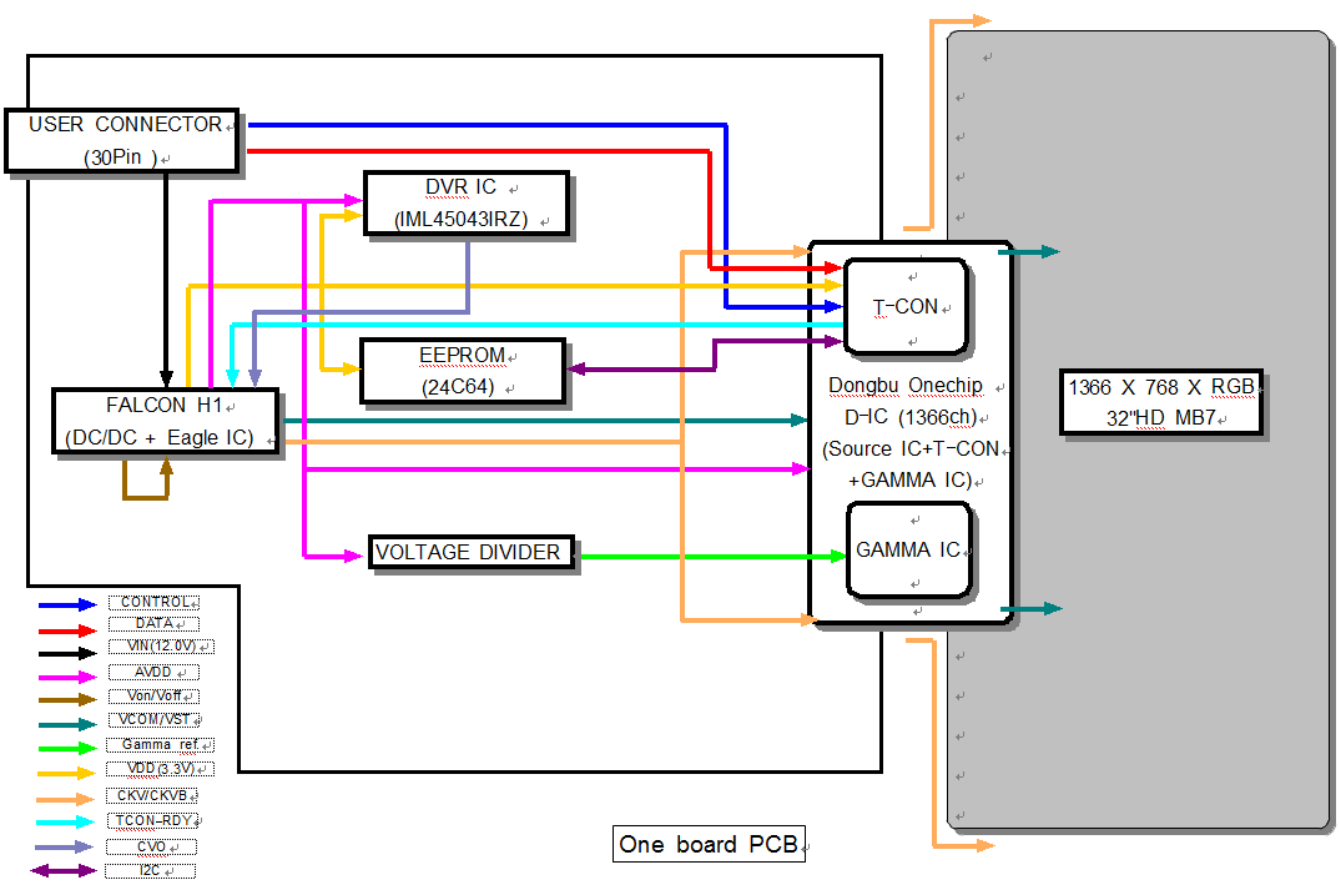

5. Input Terminal Pin Assignment

5.1. Input Signal & Power

Connector : 196260-30041 (P-TWO Industries)

PIN No.	Signal	Description	PIN No.	Signal	Description
1	HVS	SEC Internal use Only	16	GND	GND
2	SCL_I	I2C Clock	17	LV3_NI	Even LVDS Signal -
3	SDA_I	I2C Data	18	LV3_PI	Even LVDS Signal +
4	GND	GND	19	GND	GND
5	LV0_NI	LVDS Signal -	20	N.C.	No Connection
6	LV0_PI	LVDS Signal +	21	LVDS_SEL	LVDS Selection
7	GND	GND	22	WPN	Bus Release
8	LV1_NI	LVDS Signal -	23	GND	GND
9	LV1_PI	LVDS Signal +	24	GND	GND
10	GND	GND	25	N.C.	No Connection
11	LV2_NI	LVDS Signal -	26	Power	V _{DD}
12	LV2_PI	LVDS Signal +	27	Power	V _{DD}
13	GND	GND	28	Power	V _{DD}
14	LVCLK_NI	LVDS Clock -	29	Power	V _{DD}
15	LVCLK_PI	LVDS Clock +	30	Power	V _{DD}

■ Option Pin Description

These pins are CMOS interface.

Please use within the range of the following restriction.

V_{IH} : 2.4V(min) / 3.5V(max)

V_{IL} : 0.0V(min) / 0.4V(max)

■SCL : Pull up 22Ω/ 4.7kΩ

■SDA : Pull up 22Ω/ 4.7kΩ

Note(1) Pin number starts from Right side

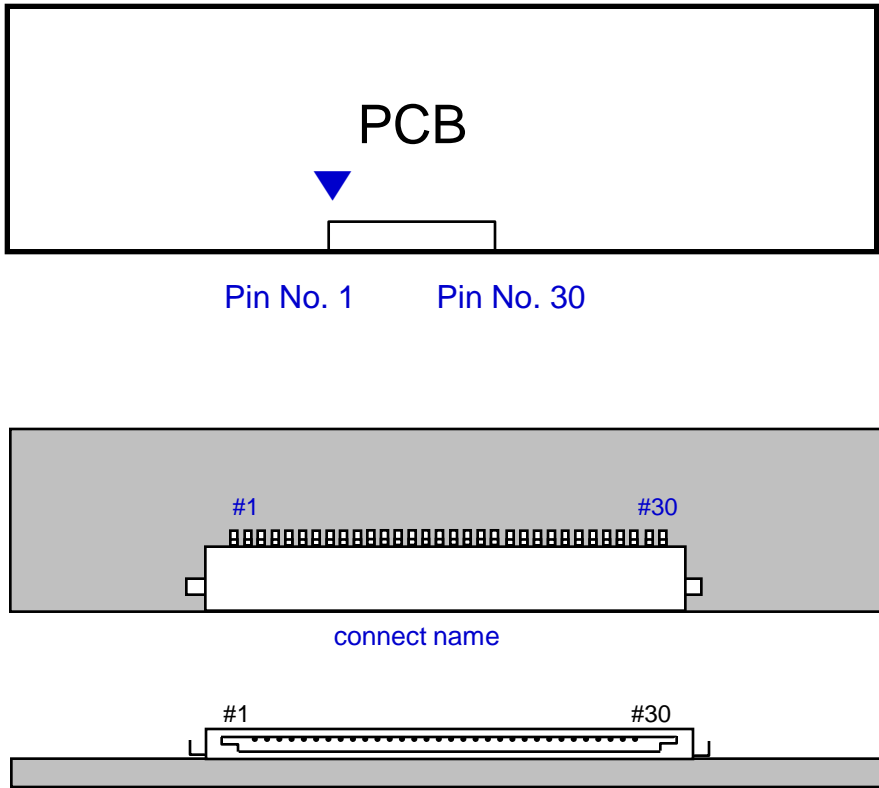

Fig. Connector diagram

- a. All GND pins should be connected together and also be connected to the LCD's metal chassis.
- b. All power input pins should be connected together.
- c. All NC pins should be separated from other signal or power.

5.2. Inverter Input Pin Configuration

Connector : 20022WR-14AML

Pin No.	Pin Configuration(FUNCTION)
1	24V
2	24V
3	24V
4	24V
5	24V
6	GND
7	GND
8	GND
9	GND
10	GND
11	Inverter Operation Status Output
12	Inverter On/Off Control Signal
13	No Connection
14	External Dimming Control Signal

5.3. Inverter Input Power Sequence

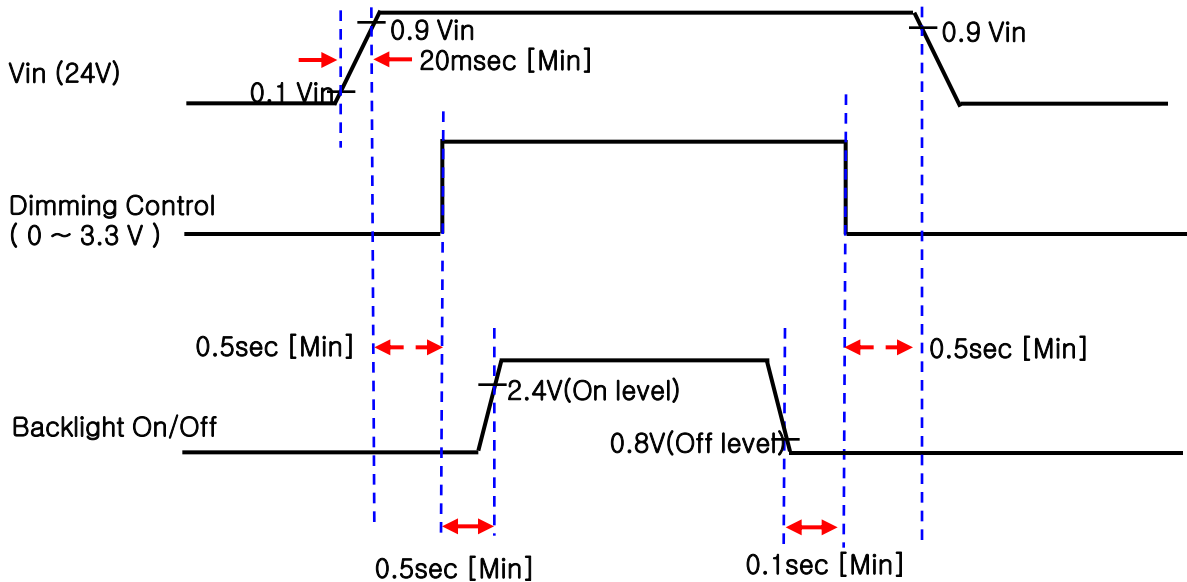

5.4. Inverter Input Power Sequence & Specification

Samsung Secret

Items	Symbol	Conditions	Specifications			Unit	Note
			Min.	Typ.	Max.		
Input Voltage	V _{in}	-	21.6	24.0	26.4	V	T _a =25±3°C
Input Current	I _{in}	V _{in} =24V EX_DIM=100%	-	3.00	3.30	A	-
Lamp Current	I _o	V _{in} =24V EX_DIM=100%	11.0	12.0	13.0	mArms	-
Operating Frequency	F _o	V _{in} =24V EX_DIM=100%	55.5	57.5	59.5	kHz	-
Backlight On/Off	ENA	ON	2.4	-	5.25	V	-
		OFF	-0.3	-	0.8		
Dimming Duty Output	D _{max}	V _{in} =24V EX_DIM=100%	100	-	-	%	Note 1
	D _{min}		15	20	25		-
	D _{min}		10	-	-		Note 2
Open Lamp Voltage	V _{open}	V _{in} =24V EX_DIM=100%	2510	-	-	V _{rms}	Note 3
Striking Time	T _{st}	V _{in} =24V EX_DIM=100%	1.0	1.5	2.0	sec	-
EX_DIM Frequency	F _{EX_DIM}	V _{in} =24.0V	120	150	180	Hz	-
PWM Signal Amplitude	V _{ex_dim}	High (On)	2.4	-	5.25	V	-
		Low (Off)	-0.3	-	0.4		

※ All data was approved after running 120minutes with LCM.

Note1. Duty Measurement [Duty(%) = T_{on} / T x 100]

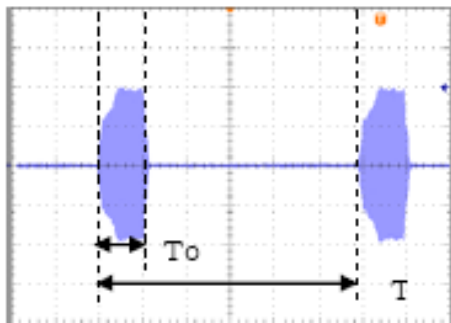

Note 2. There are not shut down and flicker at 10% @ 150Hz.

There is not shut down at 5% @ 75Hz.

Note 3. Measurement Method : Check V_s on BLU Remaining all Lamps.

5.5 LVDS Interface

Samsung Secret

	LVDS pin	Odd Data	Even Data
TxOUT/RxIN0	TxIN/RxOUT0	R0	R0
	TxIN/RxOUT1	R1	R1
	TxIN/RxOUT2	R2	R2
	TxIN/RxOUT3	R3	R3
	TxIN/RxOUT4	R4	R4
	TxIN/RxOUT6	R5	R5
	TxIN/RxOUT7	G0	G0
TxOUT/RxIN1	TxIN/RxOUT8	G1	G1
	TxIN/RxOUT9	G2	G2
	TxIN/RxOUT12	G3	G3
	TxIN/RxOUT13	G4	G4
	TxIN/RxOUT14	G5	G5
	TxIN/RxOUT15	B0	B0
	TxIN/RxOUT18	B1	B1
TxOUT/RxIN2	TxIN/RxOUT19	B2	B2
	TxIN/RxOUT20	B3	B3
	TxIN/RxOUT21	B4	B4
	TxIN/RxOUT22	B5	B5
	TxIN/RxOUT24	HSYNC	HSYNC
	TxIN/RxOUT25	VSYNC	VSYNC
	TxIN/RxOUT26	DEN	DEN
TxOUT/RxIN3	TxIN/RxOUT28	R6	R6
	TxIN/RxOUT29	R7	R7
	TxIN/RxOUT30	G6	G6
	TxIN/RxOUT31	G7	G7
	TxIN/RxOUT32	B6	B6
	TxIN/RxOUT33	B7	B7
	TxIN/RxOUT34	RESERVED	RESERVED

5.6 Input Signals, Basic Display Colors and Gray Scale of Each Color

COLOR	DISPLAY (8bit)	DATA SIGNAL																					GRAY SCALE LEVEL			
		RED							GREEN							BLUE										
		R0	R1	R2	R3	R4	R5	R6	R7	G0	G1	G2	G3	G4	G5	G6	G7	B0	B1	B2	B3	B4		B5	B6	B7
BASIC COLOR	BLACK	0	0	0	0	0	0	0	0	0	0	0	0	0	0	0	0	0	0	0	0	0	0	0	-	
	BLUE	0	0	0	0	0	0	0	0	0	0	0	0	0	0	0	0	1	1	1	1	1	1	1	1	-
	GREEN	0	0	0	0	0	0	0	0	1	1	1	1	1	1	1	1	0	0	0	0	0	0	0	0	-
	CYAN	0	0	0	0	0	0	0	0	1	1	1	1	1	1	1	1	1	1	1	1	1	1	1	1	-
	RED	1	1	1	1	1	1	1	1	0	0	0	0	0	0	0	0	0	0	0	0	0	0	0	0	-
	MAGENTA	1	1	1	1	1	1	1	1	0	0	0	0	0	0	0	0	1	1	1	1	1	1	1	1	-
	YELLOW	1	1	1	1	1	1	1	1	1	1	1	1	1	1	1	1	0	0	0	0	0	0	0	0	-
	WHITE	1	1	1	1	1	1	1	1	1	1	1	1	1	1	1	1	1	1	1	1	1	1	1	1	-
GRAY SCALE OF RED	BLACK	0	0	0	0	0	0	0	0	0	0	0	0	0	0	0	0	0	0	0	0	0	0	0	R0	
	DARK ↑	1	0	0	0	0	0	0	0	0	0	0	0	0	0	0	0	0	0	0	0	0	0	0	R1	
		0	1	0	0	0	0	0	0	0	0	0	0	0	0	0	0	0	0	0	0	0	0	0	R2	
		:	:	:	:	:	:	:	:	:	:	:	:	:	:	:	:	:	:	:	:	:	:	:	:	R3~R252
	LIGHT ↓	:	:	:	:	:	:	:	:	:	:	:	:	:	:	:	:	:	:	:	:	:	:	:	:	
		1	0	1	1	1	1	1	1	0	0	0	0	0	0	0	0	0	0	0	0	0	0	0	R253	
		0	1	1	1	1	1	1	1	0	0	0	0	0	0	0	0	0	0	0	0	0	0	0	R254	
RED	1	1	1	1	1	1	1	1	0	0	0	0	0	0	0	0	0	0	0	0	0	0	0	R255		
GRAY SCALE OF GREEN	BLACK	0	0	0	0	0	0	0	0	0	0	0	0	0	0	0	0	0	0	0	0	0	0	0	G0	
	DARK ↑	0	0	0	0	0	0	0	0	1	0	0	0	0	0	0	0	0	0	0	0	0	0	0	G1	
		0	0	0	0	0	0	0	0	0	1	0	0	0	0	0	0	0	0	0	0	0	0	0	G2	
		:	:	:	:	:	:	:	:	:	:	:	:	:	:	:	:	:	:	:	:	:	:	:	:	G3~G252
	LIGHT ↓	:	:	:	:	:	:	:	:	:	:	:	:	:	:	:	:	:	:	:	:	:	:	:	:	
		0	0	0	0	0	0	0	0	1	0	1	1	1	1	1	1	0	0	0	0	0	0	0	G253	
		0	0	0	0	0	0	0	0	0	1	1	1	1	1	1	1	0	0	0	0	0	0	0	G254	
GREEN	0	0	0	0	0	0	0	0	1	1	1	1	1	1	1	1	0	0	0	0	0	0	0	G255		
GRAY SCALE OF BLUE	BLACK	0	0	0	0	0	0	0	0	0	0	0	0	0	0	0	0	0	0	0	0	0	0	0	B0	
	DARK ↑	0	0	0	0	0	0	0	0	0	0	0	0	0	0	0	0	1	0	0	0	0	0	0	B1	
		0	0	0	0	0	0	0	0	0	0	0	0	0	0	0	0	0	1	0	0	0	0	0	B2	
		:	:	:	:	:	:	:	:	:	:	:	:	:	:	:	:	:	:	:	:	:	:	:	:	B3~B252
	LIGHT ↓	:	:	:	:	:	:	:	:	:	:	:	:	:	:	:	:	:	:	:	:	:	:	:	:	
		0	0	0	0	0	0	0	0	0	0	0	0	0	0	0	0	1	0	1	1	1	1	1	B253	
		0	0	0	0	0	0	0	0	0	0	0	0	0	0	0	0	0	1	1	1	1	1	1	B254	
BLUE	0	0	0	0	0	0	0	0	0	0	0	0	0	0	0	0	1	1	1	1	1	1	1	B255		

Note) Definition of Gray :

Rn : Red Gray, Gn : Green Gray, Bn : Blue Gray (n = Gray level)

Input Signal : 0 = Low level voltage, 1 = High level voltage

6. Interface Timing

6.1 Timing Parameters (DE only mode)

SIGNAL	ITEM	SYMBOL	MIN.	TYP.	MAX.	Unit	NOTE
Clock	Frequency	$1/T_C$	65	80	86	MHz	-
Hsync		F_H	45	48.6	53	KHz	-
Vsync		F_V	47	60	63	Hz	-
Vertical Display Term	Active Display Period	T_{VD}	768	768	768	lines	-
	Vertical Total	T_{VB}	775	810	1300	Lines	-
Horizontal Display Term	Active Display Period	T_{HD}	1366	1366	1366	clocks	-
	Horizontal Total	T_H	1450	1648	2000	clocks	-

Note) This product is DE only mode. The input of Hsync & Vsync signal does not have an effect on normal operation.

- (1) Test Point : TTL control signal and CLK at LVDS Tx input terminal in system
- (2) Internal $V_{DD} = 3.3V$

6.2 Timing diagrams of interface signal (DE only mode)

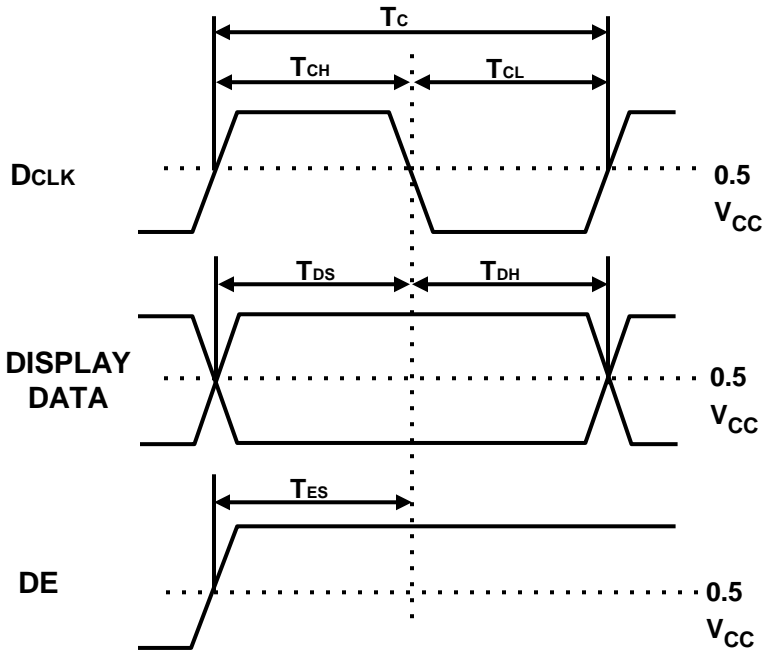
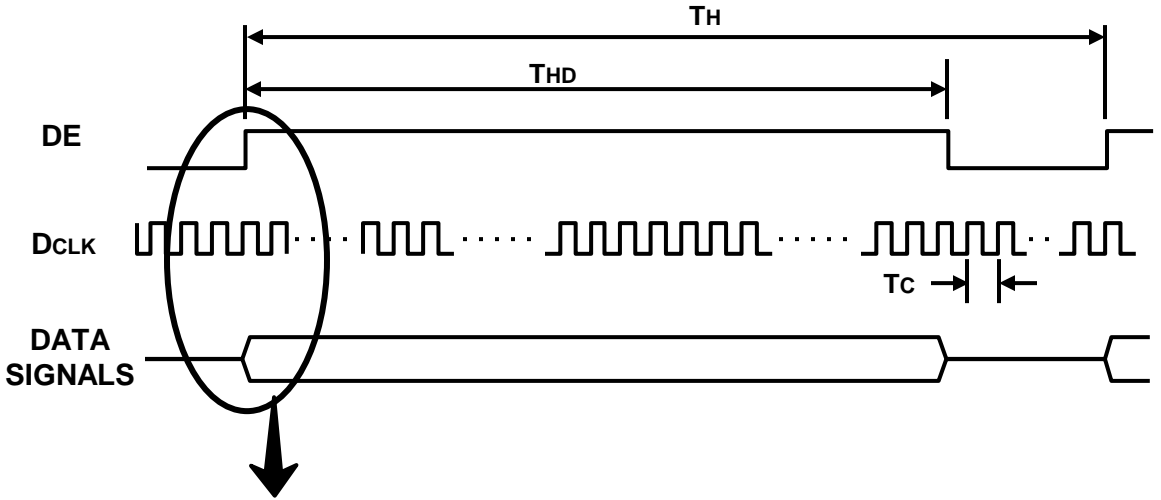
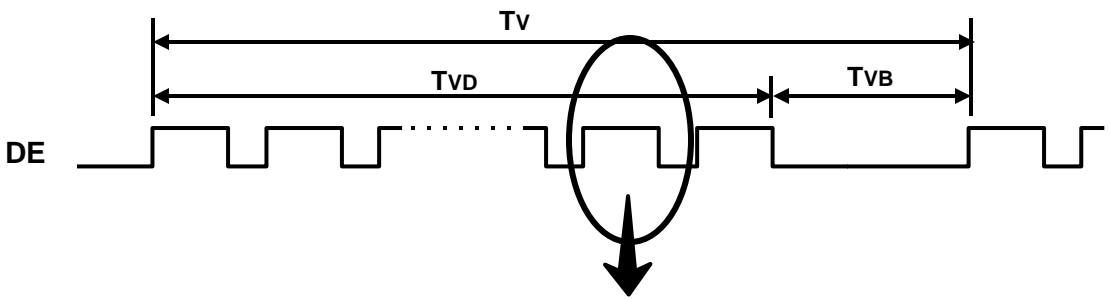

6.3 Power ON/OFF Sequence

To prevent a latch-up or DC operation of the LCD Module, the power on/off sequence should be as the diagram below.

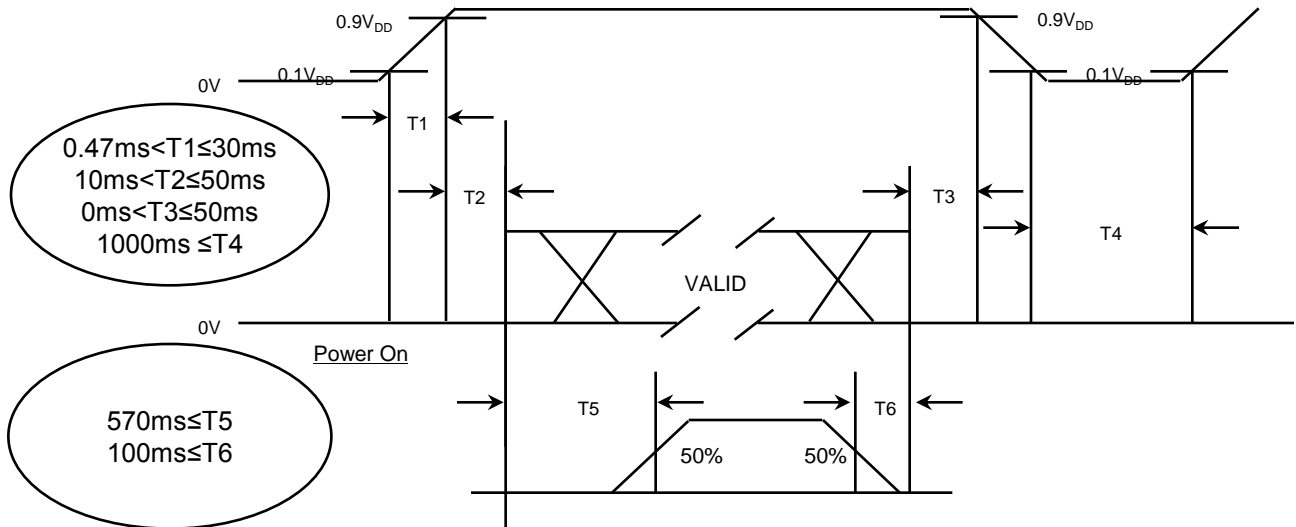

T1: V_{DD} rising time from 10% to 90%

T2: The Time from V_{DD} to data at power On.

T3: The time from valid data off to V_{DD} off at power off.

T4: V_{DD} off time for TV SET restart

T5: The time from valid data to B/L enable at power ON.

T6: The time from valid data off to B/L disable at power off.

- The supply voltage of the external system for the Module input should be the same as the definition of V_{DD} .
- Apply the lamp voltage within the LCD operation range. When the back light turns on before the LCD operation or the LCD turns off before the back light turns off, the display may momentarily show abnormal screen.
- In case of $V_{DD} =$ off level, please keep the level of input signals low or keep a high impedance.
- T4 should be measured after the Module has been fully discharged between power off and on period.
- Interface signal should not be kept at high impedance when the power is on.

7. Outline Dimension

b. Rear View

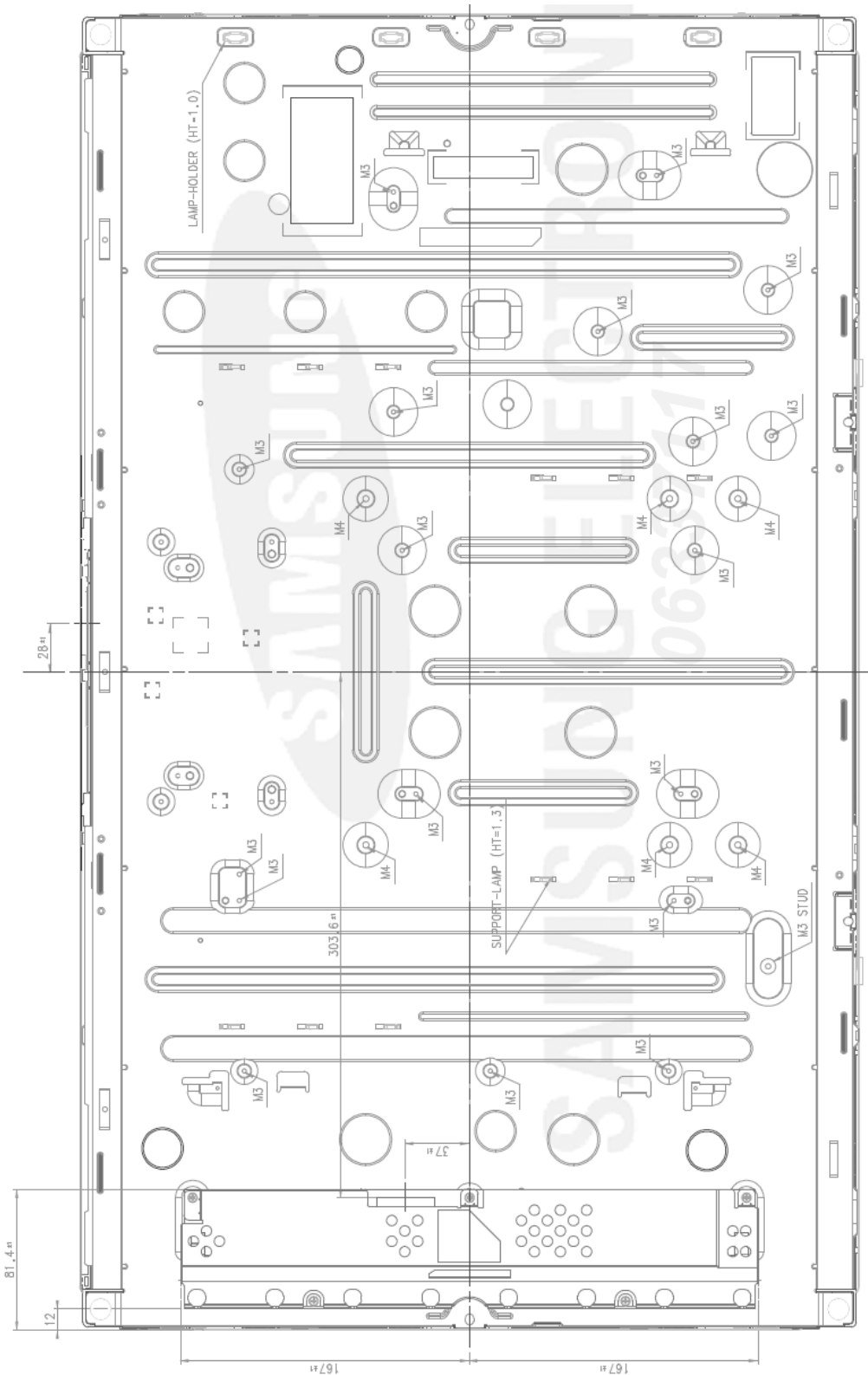

8. PACKING

Samsung Secret

※ Applied to Tangjeong

8.1 CARTON (Internal Package)

(1) Packing Form

Corrugated fiberboard box and corrugated cardboard as shock absorber

(2) Packing Method

Packing Box

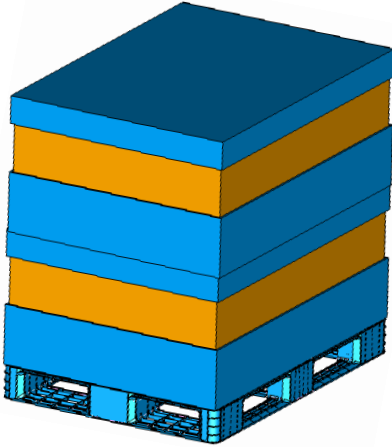

Module(26EA)

Pallet

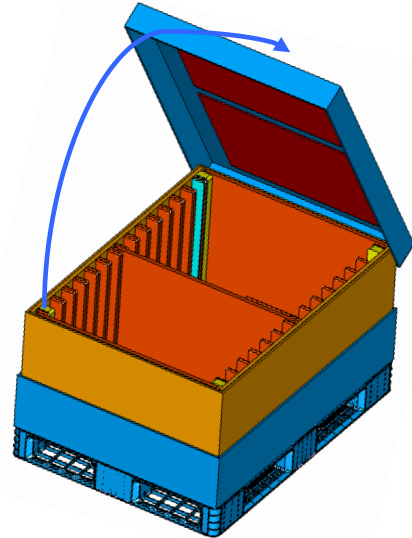

→ Direction be able to Open

8.2 Packing Specification

Item	Specification	Remark
LCD Packing	26 ea / (Packing Box)	1. 156Kg/LCD(26ea) 2. 30kg/Packing Box(2set) 3. Packing Box Material : Paper
Desiccant (Drier)	2ea/LCD	10g/ea, Cobalt-dichloride-free
Pallet	1 Box / Pallet	Pallet weight : 8kg
Packing Direction	Vertical	-
Total Pallet Size	H x V x height	1150mm x 850mm x 1125mm
Total Pallet Weight	194.52kg	Pallet(8kg) + Module(26 x 6 = 156kg) + Packing BOX(15 x 2 = 30kg) + Desiccant(0.02kg x 26 = 0.52kg)

9. MARKING & OTHERS

A nameplate bearing followed by is affixed to a shipped product at the specified location on each product.

- (1) Parts number :
- (2) Revision: One letters
- (3) Lot number : X X X X XXX XX X

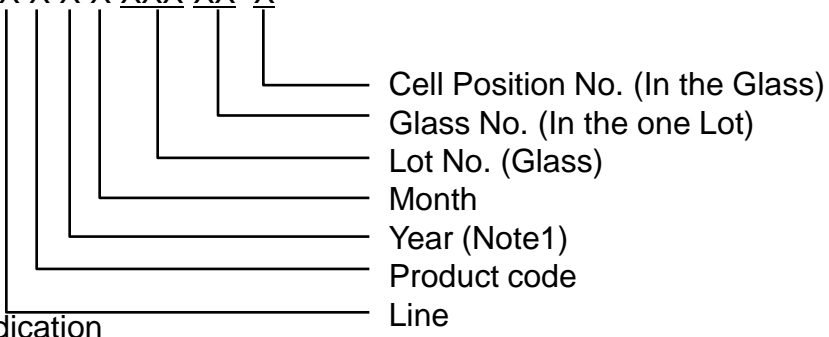

(4) Nameplate Indication

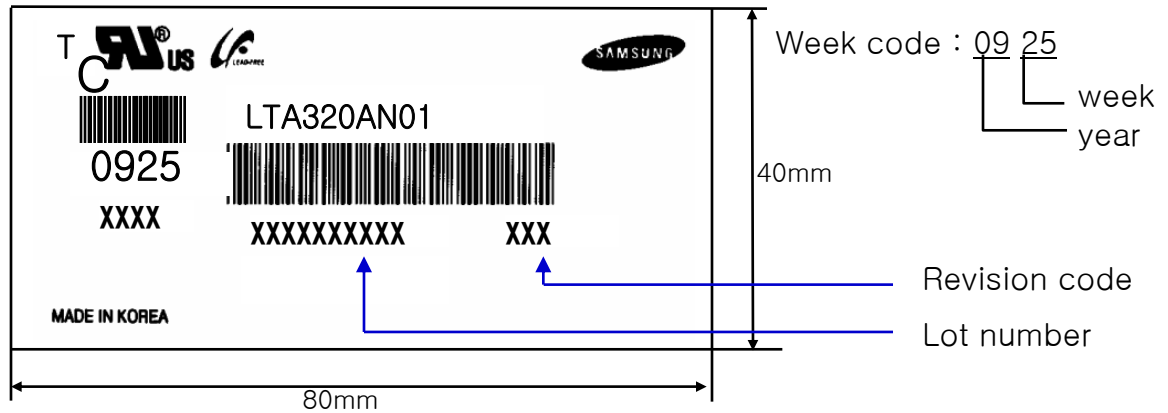

(5) Packing box attach

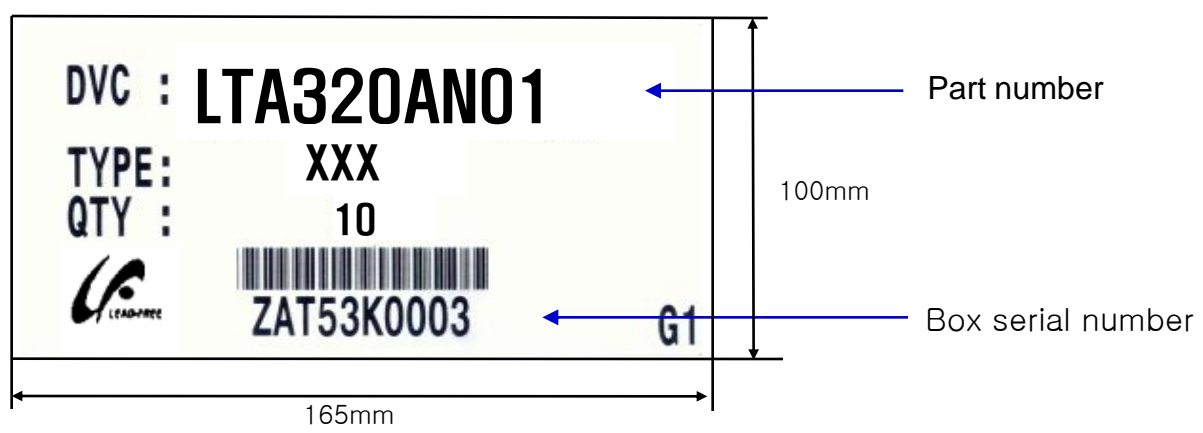

(6) Others

- 1. After service part
Lamps cannot be replaced because of the narrow bezel structure.

10. General Precautions

10.1 Handling

- (a) When the Module is assembled, it should be attached to the system firmly using all mounting holes. Be careful not to twist and bend the Module.
- (b) Because the inverter use high voltage, it should be disconnected from power before it is assembled or disassembled.
- (c) Refrain from strong mechanical shock and / or any force to the Module.
In addition to damage, this may cause improper operation or damage to the Module and CCFT back light.
- (d) Note that polarizers are very fragile and could be damage easily.
Do not press or scratch the surface harder than a HB pencil lead.
- (e) Wipe off water droplets or oil immediately. If you leave the droplets for a long time, staining or discoloration may occur.
- (f) If the surface of the polarizer is dirty, clean it using absorbent cotton or soft cloth.
- (g) Desirable cleaners are water, IPA(Isopropyl Alcohol) or Hexane.
Do not use Ketone type materials(ex. Acetone), Ethyl alcohol, Toluene, Ethyl acid or Methyl chloride. It might permanent damage to the polarizer due to chemical reaction.
- (h) If the liquid crystal material leaks from the panel, it should be kept away from the eyes or mouth . In case of contact with hands, legs or clothes, it must be washed away with soap thoroughly.
- (i) Protect the Module from static, or the CMOS Gate Array IC would be damaged.
- (j) Use finger-stalls with soft gloves in order to keep display clean during the incoming inspection and assembly process.
- (k) Do not disassemble the Module.
- (l) Do not pull or fold the lamp wire.
- (m) Do not adjust the variable resistor located on the Module.
- (n) Protection film for polarizer on the Module should be slowly peeled off just before use so that the electrostatic charge can be minimized.
- (o) Pins of I/F connector should not be touched directly with bare hands.

10.2 Storage

- (a) Do not leave the Module in high temperature, and high humidity for a long time. It is highly recommended to store the Module with temperature from 0 to 35 °C and relative humidity of less than 70%.
- (b) Do not store the TFT-LCD Module in direct sunlight.
- (c) The Module should be stored in a dark place. It is prohibited to apply sunlight or fluorescent light in storing.

10.3 Operation

- (a) No Connection or disconnect the Module in the "Power On" condition.
- (b) Power supply should always be turned on/off by the "Power on/off sequence"
- (c) Module has high frequency circuits. Sufficient suppression to the electromagnetic interference should be done by system manufacturers. Grounding and shielding methods may be important to minimize the interference.
- (d) The cable between the back light connector and its inverter power supply should be connected directly with a minimized length. A longer cable between the back light and the inverter may cause lower luminance of lamp(CCFT) and may require higher startup voltage(Vs).

10.4 Operation Condition Guide

- (a) The LCD product should be operated under normal conditions.
Normal condition is defined as below;
 - Temperature : 20 ± 15 °C
 - Humidity : 55 ± 20 %
 - Display pattern : continually changing pattern (Not stationary)
- (b) If the product will be used in extreme conditions such as high temperature, humidity, display patterns or operation time etc., It is strongly recommended to contact SEC for Application engineering advice. Otherwise, its reliability and function may not be guaranteed. Extreme conditions are commonly found at Airports, Transit Stations, Banks, Stock market, and Controlling systems.

- (a) Ultra-violet ray filter is necessary for outdoor operation.
- (b) Avoid condensation of water. It may result in improper operation or disconnection of electrode.
- (c) Do not exceed the absolute maximum rating value. (supply voltage variation, input voltage variation, variation in part contents and environmental temperature, and so on)
Otherwise the Module may be damaged.
- (d) If the Module keeps displaying the same pattern for a long period of time, the image may be "sticked" to the screen.
To avoid image sticking, it is recommended to use a screen saver.
- (e) This Module has its circuitry PCB's on the rear side and should be handled carefully in order not to be stressed.
- (f) Please contact SEC in advance when you display the same pattern for a long time.