



ELECTRONICS

Customer :

DATE : 18.Aug.2006

**SAMSUNG TFT-LCD**  
**MODEL : LTA520HT-LH3**

Any Modification of Specification is not allowed without SEC's Permission.

NOTE :

<b>Customer's Approval</b>	
SIGNATURE	DATE

APPROVAED BY <i>Kyungwon Ko</i>	DATE 18.Aug.2006
PREPARED BY <i>Jeong-Geun Han</i>	DATE 18.Aug.2006

Product Planning Group3, LCD Business  
 Samsung Electronics Co., LTD.

## Contents

Revision History	(3)
General Description	(4)
General Information	(4)
1. Absolute Maximum Ratings	(5)
2. Optical Characteristics	(7)
3. Electrical Characteristics	(10)
3.1 TFT LCD Module	
3.2 Back Light Unit	
3.3 Inverter Input & Specification	
4. Block Diagram	(13)
5. Input Terminal Pin Assignment	(14)
5.1 Input Signal & Power	
5.2 Inverter Input Pin Configuration	
5.3 Inverter Input Power Sequence	
5.4 LVDS Interface	
5.5 Input Signals, Basic Display Colors and Gray Scale of Each Color	
6. Interface Timing	(19)
6.1 Timing Parameters (DE only mode)	
6.2 Timing Diagrams of interface Signal (DE only mode)	
6.3 Power ON/OFF Sequence	
7. Outline Dimension	(22)
8. Packing	(24)
9. Marking & Others	(25)
10. General Precaution	(26)
10.1 Handling	
10.2 Storage	
10.3 Operation	
10.4 Operation Condition Guide	
10.5 Others	

**\* Revision History**

Date	Rev. No	Page	Summary
Aug 18, 2006	000	all	First issued

## General Description

### Description

LTA520HT-LH3 is a color active matrix liquid crystal display (LCD) that uses amorphous silicon TFT(Thin Film Transistor) as switching components. This model is composed of a TFT LCD panel, a driver circuit and a back light unit. The resolution of a 52.0" is 1920 x 1080 and this model can display up to 1.07 billion colors with wide viewing angle of 89° or higher in all directions. This panel is intended to support applications to provide a excellent performance for Flat Panel Display such as Home-alone Multimedia TFT-LCD TV, Display terminals for AV application products, and High Definition TV (HDTV).

### Features

- RoHS compliance (Pb-free)
- High contrast ratio, high aperture ratio, fast response time
- SPVA(Super Patterned Vertical Align) mode
- Wide viewing angle ( $\pm 178^\circ$ )
- High speed response
- Wide UXGA (1920 x 1080 pixels) resolution (16:9)
- Low Power consumption
- Direct Type 28 CCFTs(Cold Cathode Fluorescent Tube)
- DE(Data Enable) mode
- LVDS (Low Voltage Differential Signaling) interface (2pixel/clock)

## General Information

Items	Specification	Unit	Note
Module Size	1236.0(H <sub>TYP</sub> ) x 719.2(V <sub>TYP</sub> )	mm	± 1.0mm
	58.5(D <sub>MAX</sub> )		
Weight	23,000(Max.)	g	
Pixel Pitch	0.6(H) x 0.2(W)*3	mm	
Active Display Area	1152.0(H) x 648.0(V)	mm	
Surface Treatment	Haze 44% , Hard-coating (3H)		
Display Colors	10 bit – 1.07B	colors	
Number of Pixels	1920 x 1080	pixel	
Pixel Arrangement	RGB vertical stripe		
Display Mode	Normally Black		
Luminance of White	500 (Typ.)	cd/m <sup>2</sup>	

# 1. Absolute Maximum Ratings

If the condition exceeds maximum ratings, it can cause malfunction or unrecoverable damage to the device.

Item	Symbol	Min.	Max.	Unit	Note
Power Supply Voltage	V <sub>DD</sub>	GND-1	13.0	V	(1)
Storage temperature	T <sub>STG</sub>	-20	60		(2)
Glass surface temperature (Operation)	Center	T <sub>OPR</sub>	0	50	(2),(5)
	T. Uniformity	T	-	10	
Shock ( non - operating )	S <sub>nop</sub>	-	30	G	(3)
Vibration ( non - operating )	V <sub>nop</sub>	-	1.5	G	(4)

Note (1) Ta= 25 ± 2 °C

(2) Temperature and relative humidity range are shown in the figure below.

- a. 90 % RH Max. (Ta = 39 °C)
- b. Relative Humidity is 90% or less. (Ta > 39 °C)
- c. No condensation

(3) 11ms, sine wave, one time for ±X, ±Y, ±Z axis

(4) 10-300 Hz, Sweep rate 10min, 30min for X,Y,Z axis

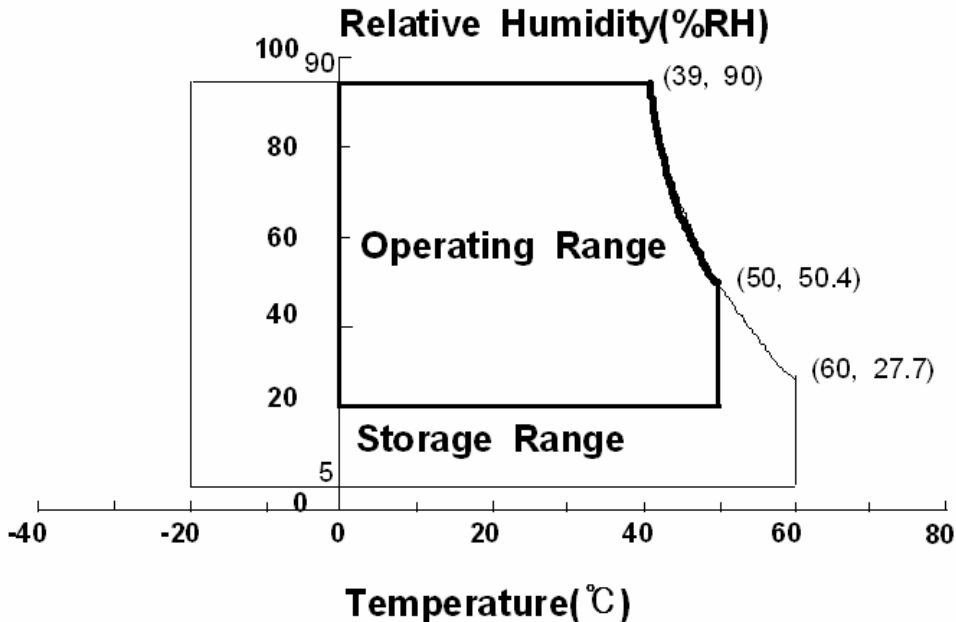
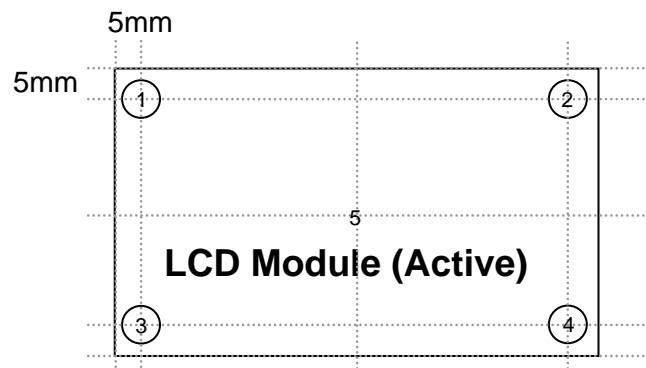

Fig. Temperature and Relative humidity range

(5) Definition of test point



T should be less than 10 (  $T = |T_{\text{OPR}} - T_{\text{MAX}}|$  )

$T_{\text{OPR}}$  : Temperature of the center of the glass surface (Test point 5)

$T_1 \sim T_4$  : Temperature of each edge of the glass surface

$T_{\text{MAX}}$  : The highest temperature of the glass surface

## 2. Optical Characteristics

The optical characteristics should be measured in a dark room or equivalent.

Measuring equipment : TOPCON BM-5A, BM-7, Photo Research PR650

( $T_a = 25 \pm 2^\circ\text{C}$ ,  $V_{DD}=12.0\text{V}$ ,  $f_v=60\text{Hz}$ ,  $f_{DCLK}=148.5\text{MHz}$ ,  $I_L = 6.0\text{mA}$ )

Item	Symbol	Condition	Min.	Typ.	Max.	Unit	Note	
Contrast Ratio (Center of screen)	C/R	Normal $\theta_{L,R}=0$ $\theta_{U,D}=0$  Viewing Angle	800	1000	-		(3) BM-5A	
Response Time	Rising		Tr	-	10	18	msec	(5) BM-7
	Falling		Tf	-	6	7		
	G-to-G		Tg	-	8	-		
Luminance of White (Center of screen)	$Y_L$			400	500	-	cd/m <sup>2</sup>	(6) BM-5A
Color Chromaticity (CIE 1931)	Red		Rx	TYP. -0.03	0.667	TYP. +0.03		(7),(8) PR650
			Ry		0.315			
	Green		Gx		0.200			
			Gy		0.650			
	Blue		Bx		0.142			
		By	0.080					
	White	Wx	0.282					
		Wy	0.294					
Color Gamut	-		-	90	-	%	(7) PR650	
Color Temperature	-		-	10000	-	K	(7) PR650	
Viewing Angle	Hor.	$\theta_L$	C/R 10	75	89	-	Degree	(8) BM-5A
		$\theta_R$		75	89	-		
	Ver.	$\theta_U$		75	89	-		
		$\theta_D$		75	89	-		
Brightness Uniformity (9 Points)	$B_{uni}$		-	-	25	%	(4) BM-5A	

### Note (1) Test Equipment Setup

The measurement should be executed in a stable, windless and dark room between 40min and 60min after lighting the back light at the given temperature for stabilization of the back light. This should be measured in the center of screen.

Single lamp current : 6.0mA

Environment condition :  $T_a = 25 \pm 2^\circ\text{C}$

Photo detector	Field
BM-5A	2 °
BM-7	2 ° / 1 °
PR650	1 °

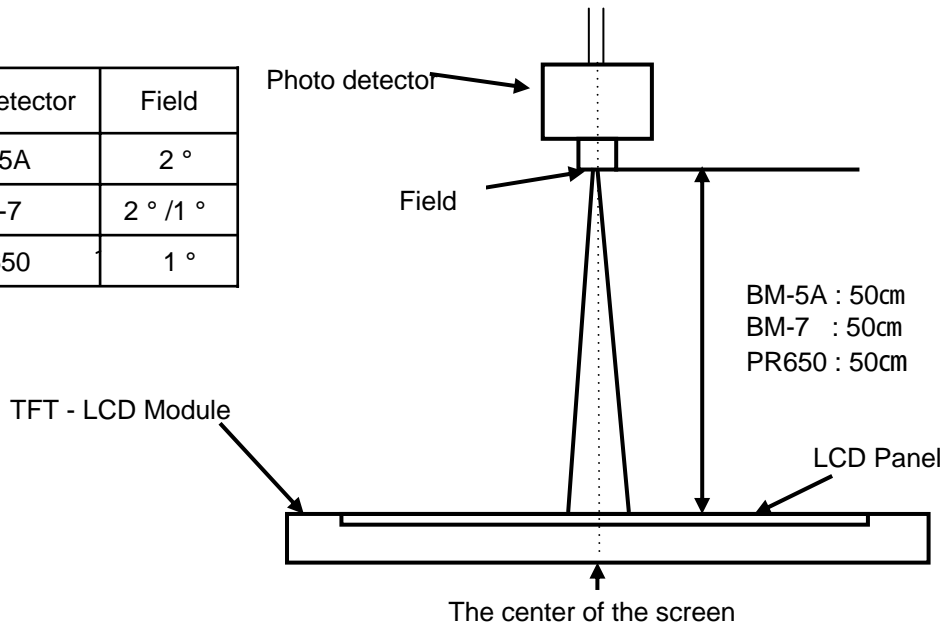

Note (2) Definition of test point

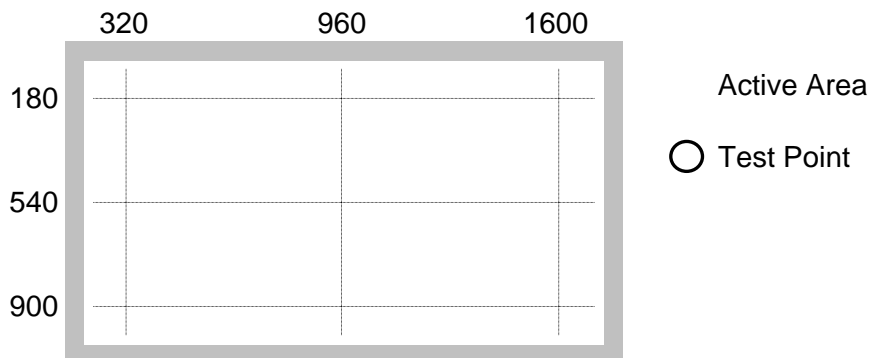

Note (3) Definition of Contrast Ratio (C/R)

: Ratio of gray max (Gmax) & gray min (Gmin) at the center point of the panel

$$C/R = \frac{G_{\max}}{G_{\min}}$$

Gmax : Luminance with all pixels white

Gmin : Luminance with all pixels black



Note (4) Definition of 9 points brightness uniformity

$$B_{uni} = 100 * \frac{(B_{max} - B_{min})}{B_{max}}$$

Bmax : Maximum brightness

Bmin : Minimum brightness

Note (5) Definition of Response time : Sum of Tr, Tf

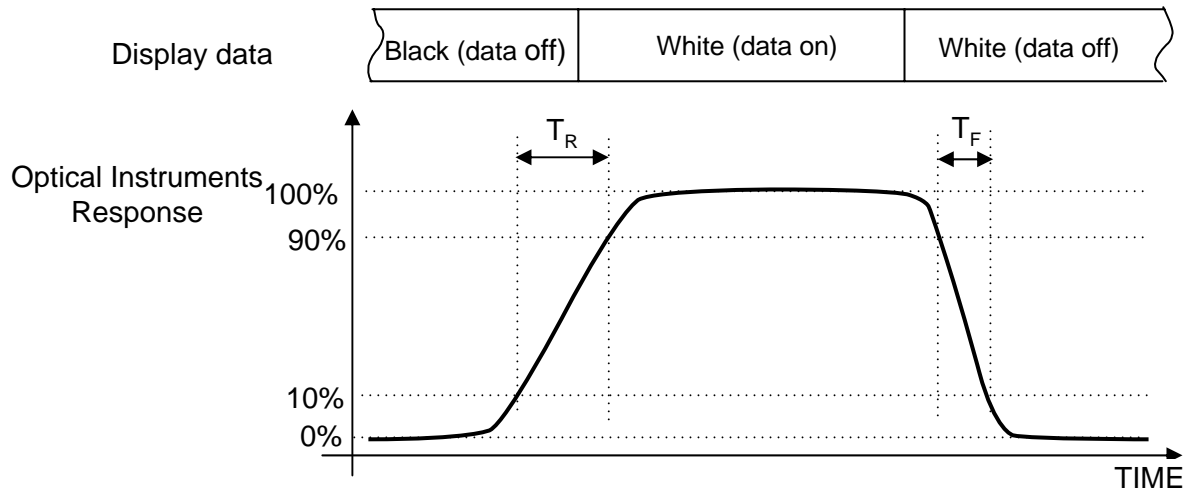

Note (6) Definition of Luminance of White : Luminance of white at center point

Note (7) Definition of Color Chromaticity (CIE 1931)

Color coordinate of Red, Green, Blue & White at center point

Note (8) Definition of Viewing Angle

: Viewing angle range (C/R 10)

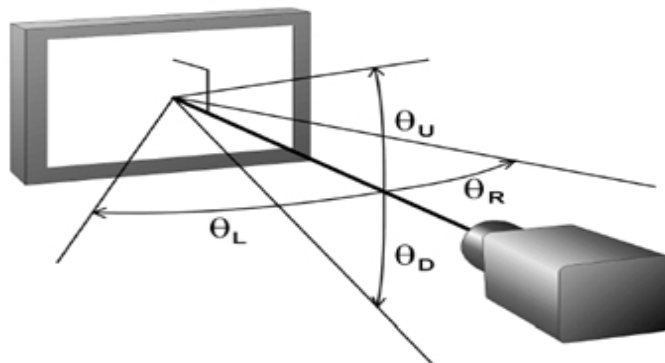

### 3. Electrical Characteristics

#### 3.1 TFT LCD Module

The connector for display data & timing signal should be connected.

$T_a = 25^\circ\text{C} \pm 2^\circ\text{C}$

Item	Symbol	Min.	Typ.	Max.	Unit	Note
Voltage of Power Supply	$V_{DD}$	11	12	13	V	(1)
Current of Power Supply	(a) Black	-	1000	-	mA	(2),(3)
	(b) White	-	1300	-	mA	
	(c) N-Pattern	-	1200	1400	mA	
Vsync Frequency	$f_V$	48.0	60.0	62.0	Hz	
Hsync Frequency	$f_H$	50.0	67.5	75.0	kHz	
Main Frequency	$f_{DCLK}$	130.0	148.5	155.0	MHz	
Rush Current	$I_{RUSH}$	-	-	5	A	(4)

Note (1) The ripple voltage should be controlled under 10% of  $V_{DD}$ .

(2)  $f_V=60\text{Hz}$ ,  $f_{DCLK} = 148.5\text{MHz}$ ,  $V_{DD} = 12.0\text{V}$ , DC Current.

(3) Power dissipation check pattern (LCD Module only)

a) Black Pattern

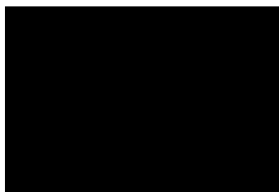

b) White Pattern



c) N-Pattern

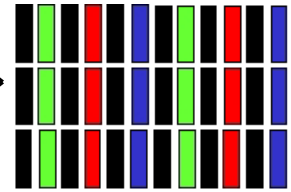
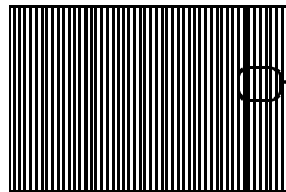

#### (4) Measurement Conditions

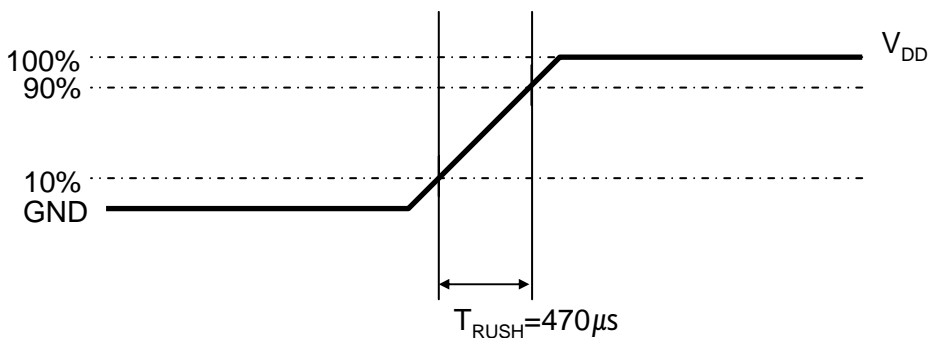

Rush Current  $I_{RUSH}$  can be measured when  $T_{RUSH}$  is  $470\mu s$ .

### 3.2 Back Light Unit

The back light unit contains 28 direct-lighting type CCFTs ( Cold Cathode Fluorescent Tube ). The characteristics of lamps are shown in the following tables.

Ta=25 ± 2°C

Item	Symbol	Min.	Typ.	Max.	Unit	Note
Lamp Current	$I_L$	4.0	6.0	7.0	mArms	
Lamp Voltage	$V_L$	-	1620	-	Vrms	
Operating Life Time	Hr	30,000	-	-	Hour	(1)

Note (1) It is defined as the time to take until the brightness reduces to 50% of its original value.

[Operating condition : Ta = 25±2 , IL = 6.0mArms(typ.), For single lamp only. ]

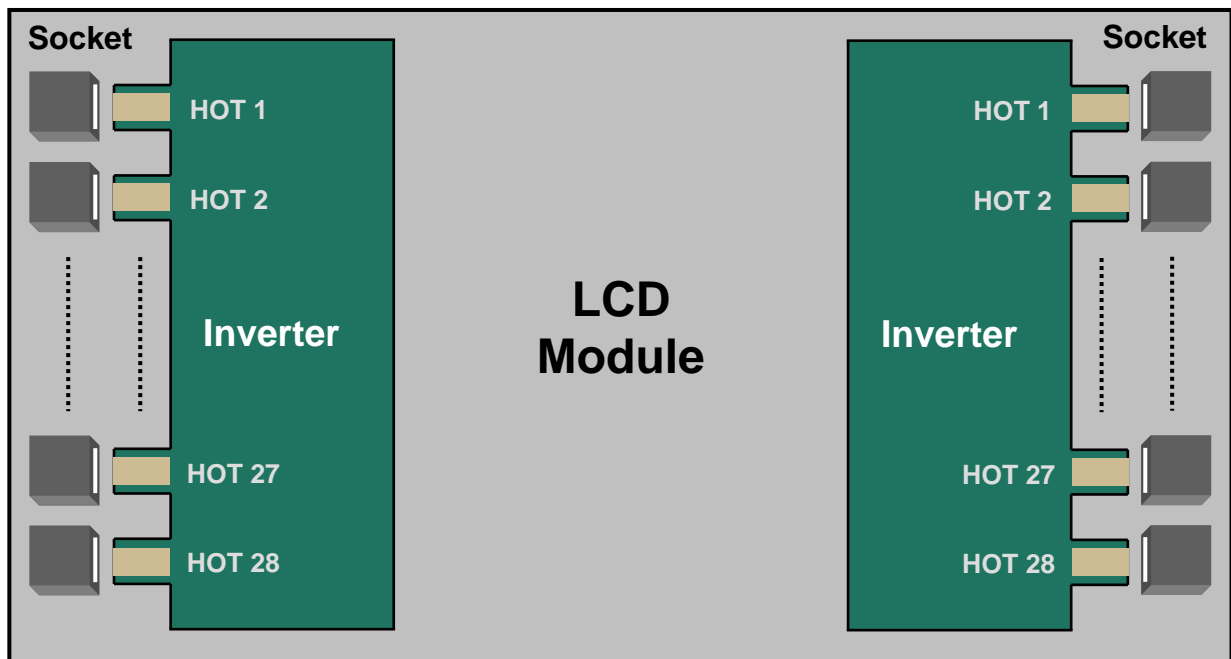

### 3.3 Inverter Input Condition & Specification

Items	Symbol	Conditions	Specifications			Unit	Note
			Min.	Typ.	Max.		
Input Voltage	V <sub>in</sub>	-	23	24	25	V	Ta=25±2 °C
Input Current	I <sub>RUSH</sub>	V <sub>in</sub> =24.0V V <sub>dim</sub> =3.3V	-	-	15	A	Initial Turn-on
Lamp Current	I <sub>O</sub>	V <sub>dim</sub> =3.3 V	5.5	6.0	6.5	mArms	-
Frequency	F <sub>LAMP</sub>	V <sub>in</sub> =24.0 V	46.0	48.5	51.0	kHz	-
Backlight On/Off	ON	V <sub>in</sub> =24.0 V	2.4	-	5.25	V	-
	OFF	V <sub>in</sub> =24.0 V	-0.3	-	0.8		
Dimming Control	V <sub>DIM</sub>	Max Lum	-	-	3.3	V	-
		Min. Lum	0.0	-	-		

#### 4. Block Diagram

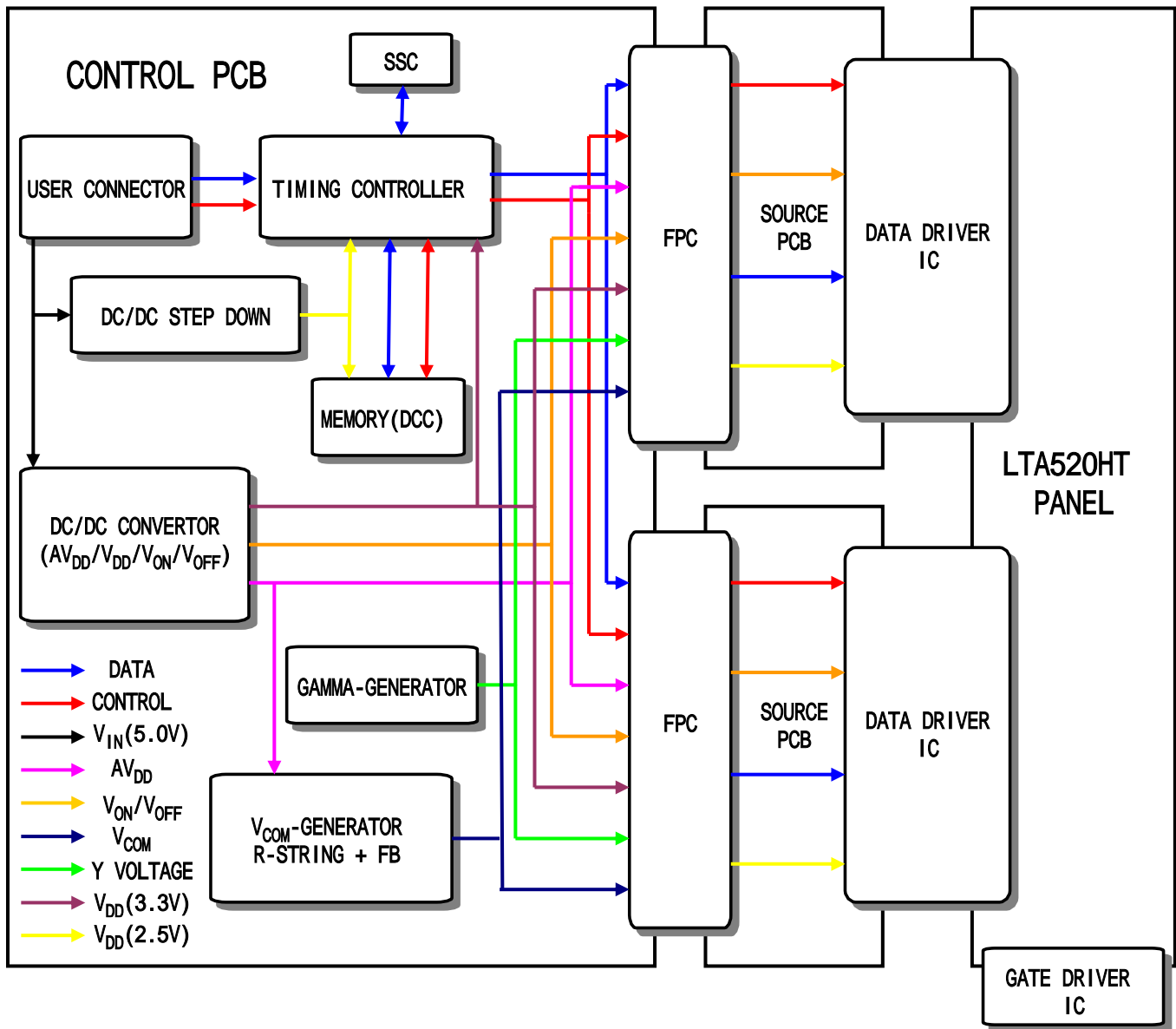

## 5. Input Terminal Pin Assignment

### 5.1. Input Signal & Power

Connector : FI-RE51S-HF (JAE)

Pin	Symbol	Description	Pin	Symbol	Description
1	Power	DC 12V	26	RE[0]P	Even LVDS Signal +
2	Power	DC 12V	27	RE[0]P	Even LVDS Signal -
3	Power	DC 12V	28	RE[0]P	Even LVDS Signal +
4	Power	DC 12V	29	RE[0]P	Even LVDS Signal -
5	Power	DC 12V	30	RE[0]P	Even LVDS Signal +
6	GND	GND	31	GND	GND
7	GND	GND	32	ROCLK-	Even LVDS Signal -
8	GND	GND	33	ROCLK+	Even LVDS Signal +
9	GND	GND	34	GND	GND
10	RO[0]N	Odd LVDS Signal -	35	RO[3]N	Even LVDS Signal -
11	RO[0]P	Odd LVDS Signal +	36	RO[3]P	Even LVDS Signal +
12	RO[1]N	Odd LVDS Signal -	37	RO[4]N	Even LVDS Signal -
13	RO[1]P	Odd LVDS Signal +	38	RO[4]P	Even LVDS Signal +
14	RO[2]N	Odd LVDS Signal -	39	GND	GND
15	RO[2]P	Odd LVDS Signal +	40	NC	NC
16	GND	GND	41	NC	NC
17	ROCLK-	Odd LVDS Signal -	42	NC	NC
18	ROCLK+	Odd LVDS Signal +	43	NC	NC
19	GND	GND	44	NC	NC
20	RO[3]N	Odd LVDS Signal -	45	NC	NC
21	RO[3]P	Odd LVDS Signal +	46	NC	NC
22	RO[4]N	Odd LVDS Signal -	47	NC	NC
23	RO[4]P	Odd LVDS Signal +	48	NC	NC
24	GND	GND	49	NC	NC
25	RE[0]N	Even LVDS Signal -	50	NC	NC
			51	NC	NC

Note(1) Pin number starts from Right side

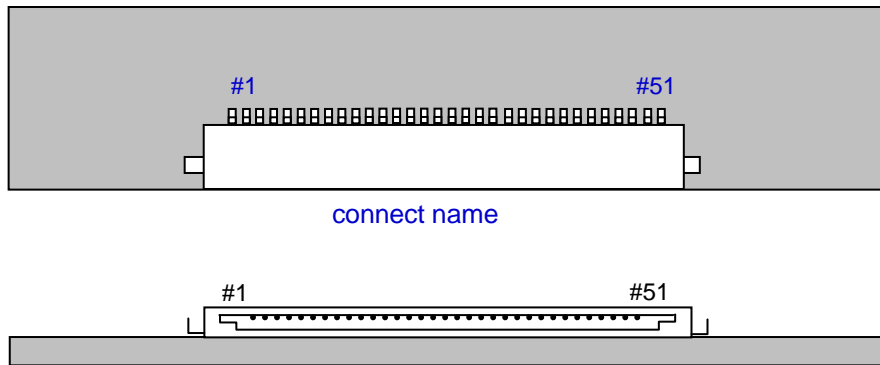
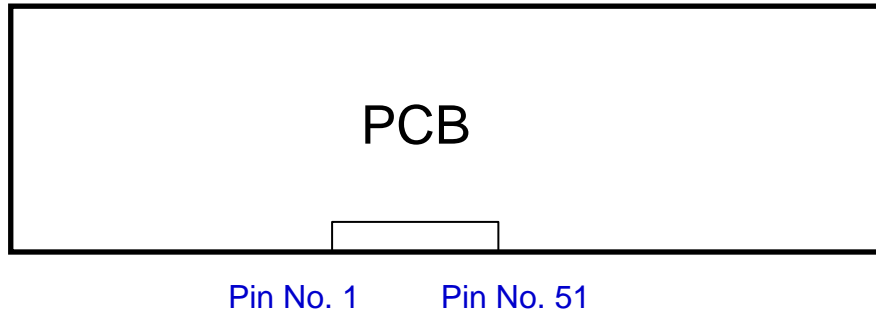

**Fig. Connector diagram**

- a. All GND pins should be connected together and also be connected to the LCD's metal chassis.
- b. All power input pins should be connected together.
- c. All NC pins should be separated from other signal or power.

### 5.2. Inverter Input Pin Configuration

Connector : S14B-PHA-SM-TB(LF) (JST)

Pin No.	Pin Configuration(FUNCTION)
1	24 V
2	24 V
3	24 V
4	24 V
5	24 V
6	GND
7	GND
8	GND
9	GND
10	GND
11	No Connection * ERROR DETECTION (NORMAL : GND / ABNORMAL : 5V)
12	Backlight On /Off [ON: 2.4 - 5.25 V, OFF: -0.3 - 0.8 V]
13	Dimming Control [0V:Min, 3.3V:Max]
14	No Connection

### 5.3. Inverter Input Power Sequence

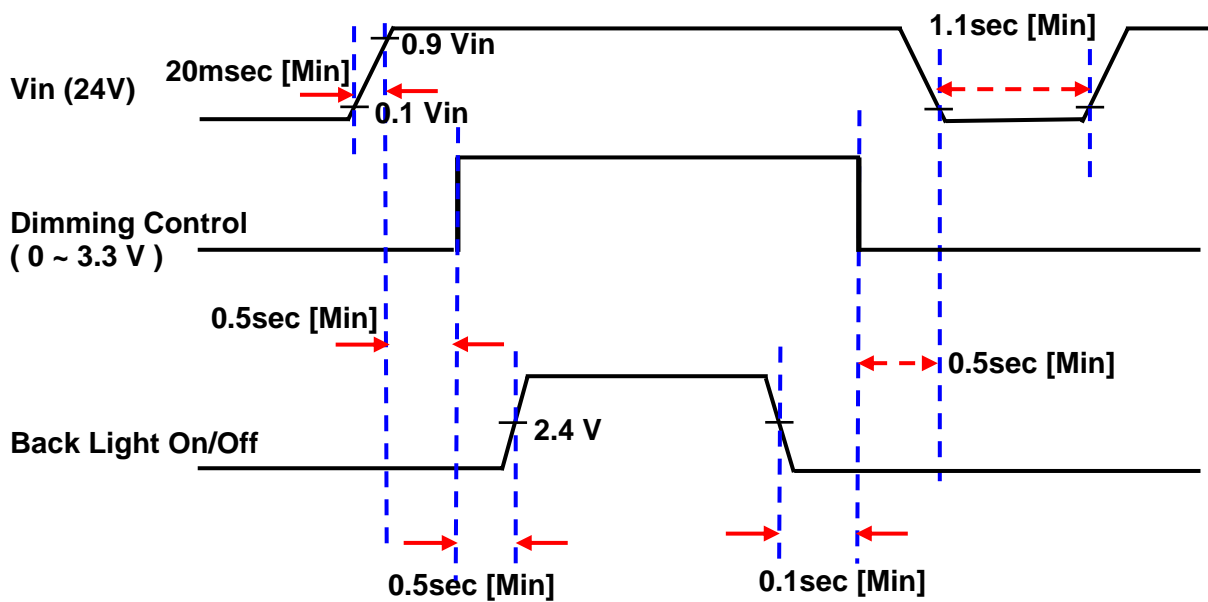



### 5.3 LVDS Interface

- LVDS Receiver : Tcon (merged)
- Data Format (JEIDA)

	LVDS pin	JEIDA -DATA
TxOUT/RxIN0	TxIN/RxOUT0	R4
	TxIN/RxOUT1	R5
	TxIN/RxOUT2	R6
	TxIN/RxOUT3	R7
	TxIN/RxOUT4	R8
	TxIN/RxOUT6	R9
	TxIN/RxOUT7	G4
TxOUT/RxIN1	TxIN/RxOUT8	G5
	TxIN/RxOUT9	G6
	TxIN/RxOUT12	G7
	TxIN/RxOUT13	G8
	TxIN/RxOUT14	G9
	TxIN/RxOUT15	B4
	TxIN/RxOUT18	B5
TxOUT/RxIN2	TxIN/RxOUT19	B6
	TxIN/RxOUT20	B7
	TxIN/RxOUT21	B8
	TxIN/RxOUT22	B9
	TxIN/RxOUT24	HSYNC
	TxIN/RxOUT25	VSYNC
	TxIN/RxOUT26	DEN
TxOUT/RxIN3	TxIN/RxOUT27	R2
	TxIN/RxOUT5	R3
	TxIN/RxOUT10	G2
	TxIN/RxOUT11	G3
	TxIN/RxOUT16	B2
	TxIN/RxOUT17	B3
	TxIN/RxOUT23	RESERVED
TxOUT/RxIN4	TxIN/RxOUT28	R0
	TxIN/RxOUT29	R1
	TxIN/RxOUT30	G0
	TxIN/RxOUT31	G1
	TxIN/RxOUT32	B0
	TxIN/RxOUT33	B1
	TxIN/RxOUT34	RESERVED

### 5.5 Input Signals, Basic Display Colors and Gray Scale of Each Color

COLOR	DISPLAY (8bit)	DATA SIGNAL																												GRAY SCALE LEVEL	
		RED									GREEN									BLUE											
		R0	R1	R2	R3	R4	R5	R6	R7	R8	R9	G0	G1	G2	G3	G4	G5	G6	G7	G8	G9	B0	B1	B2	B3	B4	B5	B6	B7		B8
BASIC COLOR	BLACK	0	0	0	0	0	0	0	0	0	0	0	0	0	0	0	0	0	0	0	0	0	0	0	0	0	0	0	0	0	-
	BLUE	0	0	0	0	0	0	0	0	0	0	0	0	0	0	0	0	0	0	0	0	1	1	1	1	1	1	1	1	1	-
	GREEN	0	0	0	0	0	0	0	0	0	0	1	1	1	1	1	1	1	1	1	1	0	0	0	0	0	0	0	0	0	-
	CYAN	0	0	0	0	0	0	0	0	0	0	1	1	1	1	1	1	1	1	1	1	1	1	1	1	1	1	1	1	1	-
	RED	1	1	1	1	1	1	1	1	1	1	0	0	0	0	0	0	0	0	0	0	0	0	0	0	0	0	0	0	0	-
	MAGENTA	1	1	1	1	1	1	1	1	1	1	0	0	0	0	0	0	0	0	0	0	1	1	1	1	1	1	1	1	1	-
	YELLOW	1	1	1	1	1	1	1	1	1	1	1	1	1	1	1	1	1	1	1	1	0	0	0	0	0	0	0	0	0	-
	WHITE	1	1	1	1	1	1	1	1	1	1	1	1	1	1	1	1	1	1	1	1	1	1	1	1	1	1	1	1	1	-
GRAY SCALE OF RED	BLACK	0	0	0	0	0	0	0	0	0	0	0	0	0	0	0	0	0	0	0	0	0	0	0	0	0	0	0	0	R0	
	DARK	1	0	0	0	0	0	0	0	0	0	0	0	0	0	0	0	0	0	0	0	0	0	0	0	0	0	0	0	R1	
		0	1	0	0	0	0	0	0	0	0	0	0	0	0	0	0	0	0	0	0	0	0	0	0	0	0	0	0	R2	
		:	:	:	:	:	:	:	:	:	:	:	:	:	:	:	:	:	:	:	:	:	:	:	:	:	:	:	:	R3~ R1020	
		:	:	:	:	:	:	:	:	:	:	:	:	:	:	:	:	:	:	:	:	:	:	:	:	:	:	:	:	:	
	LIGHT	1	0	1	1	1	1	1	1	1	1	0	0	0	0	0	0	0	0	0	0	0	0	0	0	0	0	0	0	R1021	
		0	1	1	1	1	1	1	1	1	1	0	0	0	0	0	0	0	0	0	0	0	0	0	0	0	0	0	0	R1022	
	RED	1	1	1	1	1	1	1	1	1	1	0	0	0	0	0	0	0	0	0	0	0	0	0	0	0	0	0	0	R1023	
GRAY SCALE OF GREEN	BLACK	0	0	0	0	0	0	0	0	0	0	0	0	0	0	0	0	0	0	0	0	0	0	0	0	0	0	0	0	G0	
	DARK	0	0	0	0	0	0	0	0	0	0	1	0	0	0	0	0	0	0	0	0	0	0	0	0	0	0	0	0	G1	
		0	0	0	0	0	0	0	0	0	0	0	1	0	0	0	0	0	0	0	0	0	0	0	0	0	0	0	0	G2	
		:	:	:	:	:	:	:	:	:	:	:	:	:	:	:	:	:	:	:	:	:	:	:	:	:	:	:	:	G3~ G1020	
		:	:	:	:	:	:	:	:	:	:	:	:	:	:	:	:	:	:	:	:	:	:	:	:	:	:	:	:	:	
	LIGHT	0	0	0	0	0	0	0	0	0	0	1	0	1	1	1	1	1	1	1	1	1	0	0	0	0	0	0	0	G1021	
		0	0	0	0	0	0	0	0	0	0	0	1	1	1	1	1	1	1	1	1	1	0	0	0	0	0	0	0	G1022	
	GREEN	0	0	0	0	0	0	0	0	0	0	1	1	1	1	1	1	1	1	1	1	1	0	0	0	0	0	0	0	G1023	
GRAY SCALE OF BLUE	BLACK	0	0	0	0	0	0	0	0	0	0	0	0	0	0	0	0	0	0	0	0	0	0	0	0	0	0	0	0	B0	
	DARK	0	0	0	0	0	0	0	0	0	0	0	0	0	0	0	0	0	0	0	0	0	0	0	0	0	0	0	0	B1	
		0	0	0	0	0	0	0	0	0	0	0	0	0	0	0	0	0	0	0	0	0	0	0	0	0	0	0	0	B2	
		:	:	:	:	:	:	:	:	:	:	:	:	:	:	:	:	:	:	:	:	:	:	:	:	:	:	:	:	B3~ B1020	
		:	:	:	:	:	:	:	:	:	:	:	:	:	:	:	:	:	:	:	:	:	:	:	:	:	:	:	:	:	
	LIGHT	0	0	0	0	0	0	0	0	0	0	0	0	0	0	0	0	0	0	0	0	0	0	0	0	0	0	0	B1021		
		0	0	0	0	0	0	0	0	0	0	0	0	0	0	0	0	0	0	0	0	0	0	0	0	0	0	0	0	B1022	
	BLUE	0	0	0	0	0	0	0	0	0	0	0	0	0	0	0	0	0	0	0	0	0	0	0	0	0	0	0	0	B1023	

Note) Definition of Gray :  
 Rn : Red Gray, Gn : Green Gray, Bn : Blue Gray (n = Gray level)  
 Input Signal : 0 = Low level voltage, 1 = High level voltage

## 6. Interface Timing

### 6.1 Timing Parameters ( DE only mode )

SIGNAL	ITEM	SYMBOL	MIN.	TYP.	MAX.	Unit	NOTE
Clock	Frequency	$1/T_C$	130.0	148.5	155.0	MHz	-
Hsync		$F_H$	50.0	67.5	75.0	KHz	-
Vsync		$F_V$	48.0	60.0	62.0	Hz	-
Vertical Display Term	Active Display Period	$T_{VD}$	-	1080	-	lines	-
	Vertical Total	$T_{VB}$	1100	1125	1480	lines	-
Horizontal Display Term	Active Display Period	$T_{HD}$	-	1920	-	clocks	-
	Horizontal Total	$T_H$	2150	2300	2450	clocks	-

Note) This product is DE only mode. The input of Hsync & Vsync signal does not have an effect on normal operation.

- (1) Test Point : TTL control signal and CLK at LVDS Tx input terminal in system
- (2) Internal  $V_{DD} = 3.3V$

## 6.2 Timing diagrams of interface signal ( DE only mode )

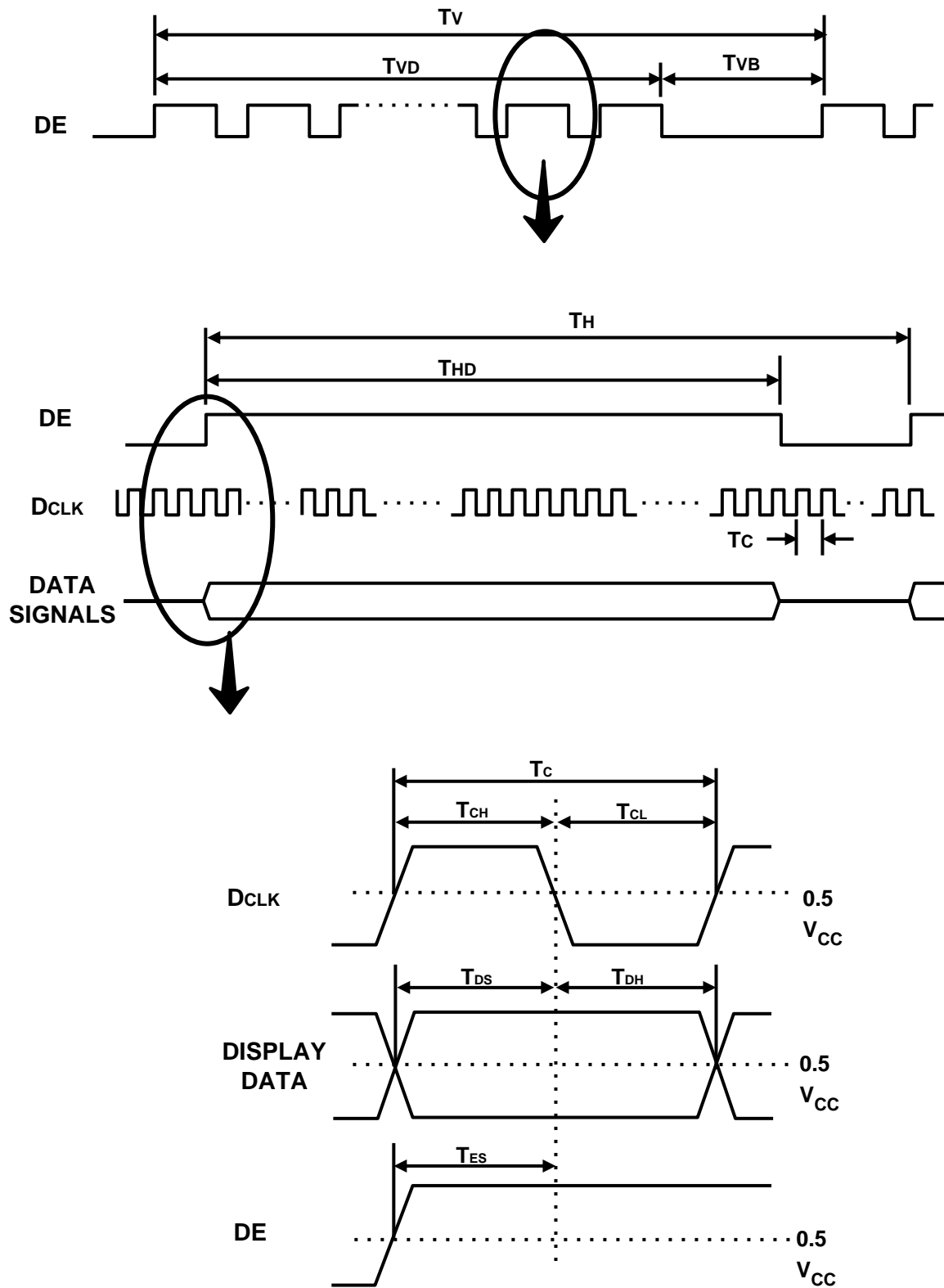

### 6.3 Power ON/OFF Sequence

To prevent a latch-up or DC operation of the LCD Module, the power on/off sequence should be as the diagram below.

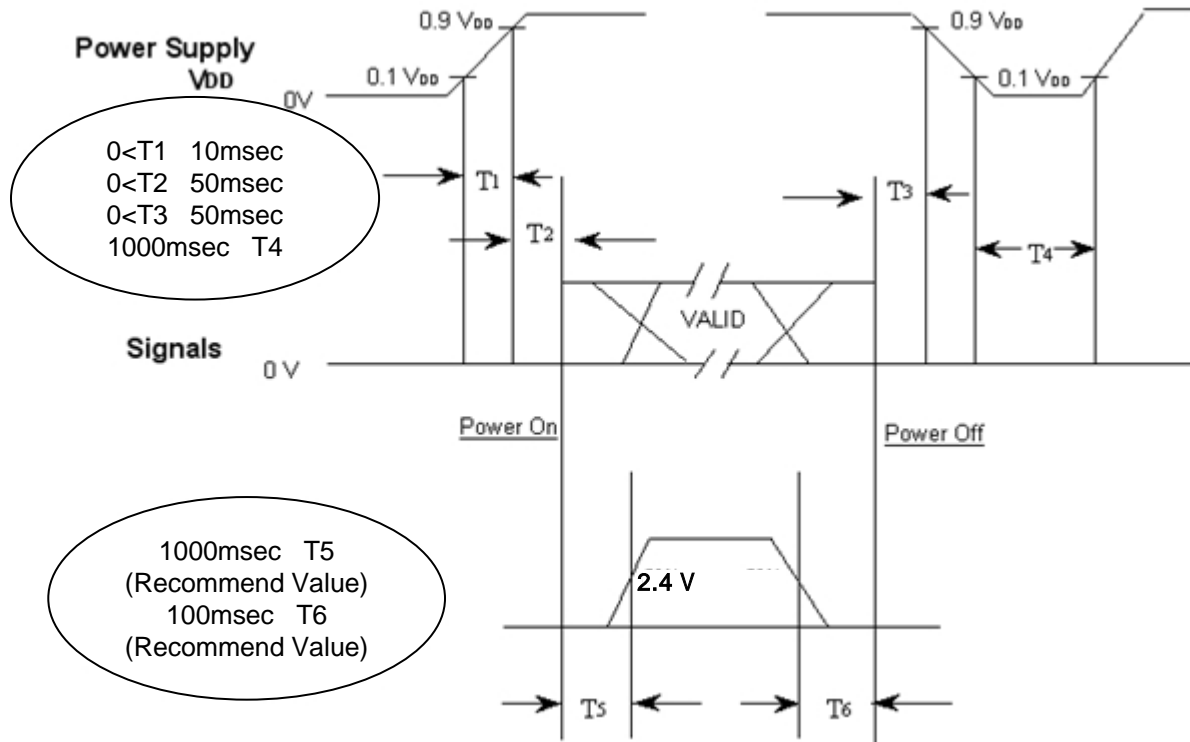

- T1 :  $V_{DD}$  rising time from 10% to 90%
- T2 : The time from  $V_{DD}$  to valid data at power ON.
- T3 : The time from valid data off to  $V_{DD}$  off at power Off.
- T4 :  $V_{DD}$  off time for Windows restart
- T5 : The time from valid data to B/L enable at power ON.
- T6 : The time from valid data off to B/L disable at power Off.

- The supply voltage of the external system for the Module input should be the same as the definition of  $V_{DD}$ .
- Apply the lamp voltage within the LCD operation range. When the back light turns on before the LCD operation or the LCD turns off before the back light turns off, the display may momentarily show abnormal screen.
- In case of  $V_{DD}$  = off level, please keep the level of input signals low or keep a high impedance.
- T4 should be measured after the Module has been fully discharged between power off and on period.
- Interface signal should not be kept at high impedance when the power is on.

# 7. Outline Dimension (Front View)

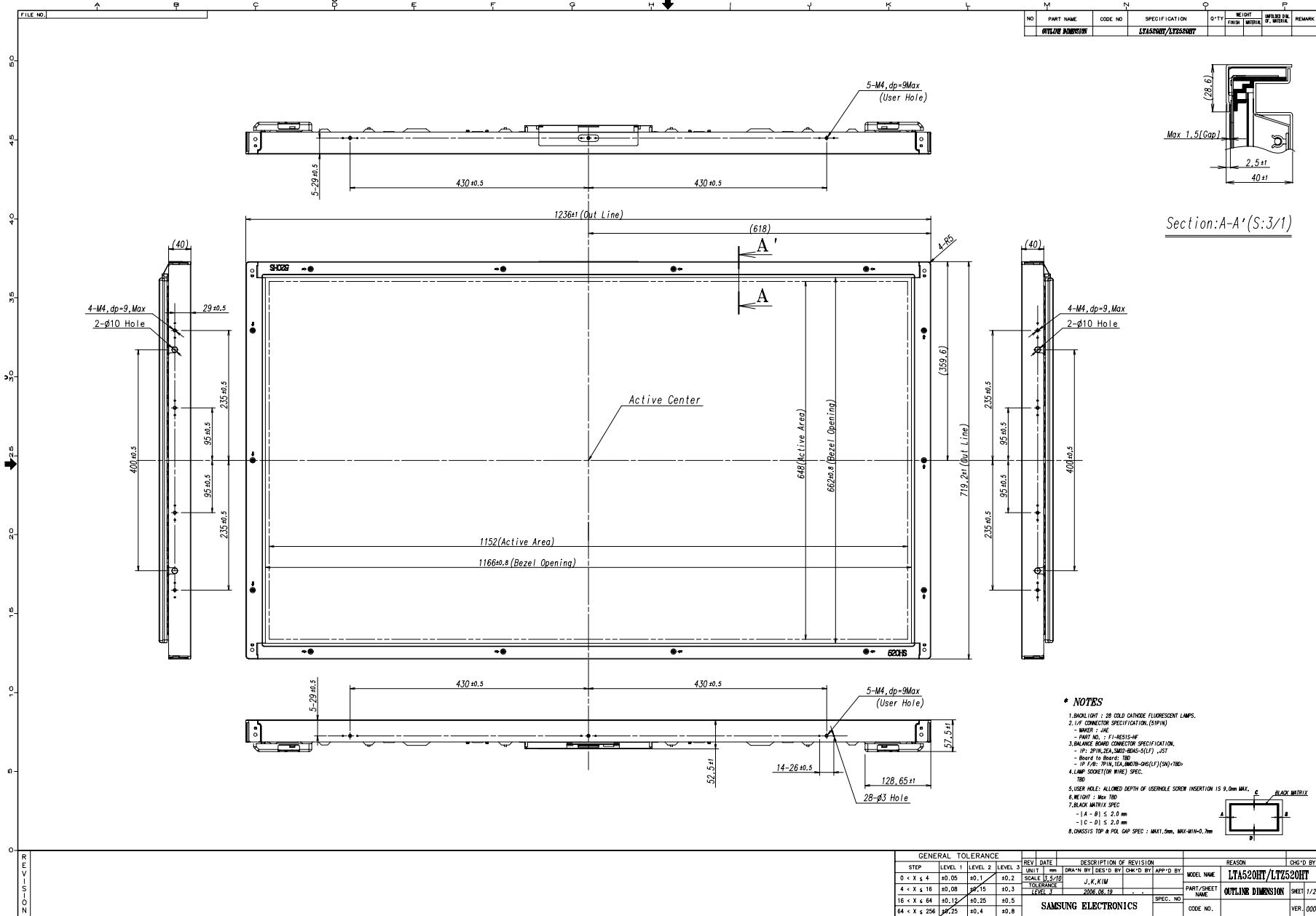

**\* NOTES**

1. BACKLIGHT : 28 GOLD OUTSIDE FLUORESCENT LAMPS.
2. I/F CONNECTOR SPECIFICATION (SMT)
  - MATE : JAE
  - PART NO. : F1-BASIC-HP
3. BALANCE BOARD CONNECTOR SPECIFICATION
  - I/F : 2P16, 2EA, SMP-20AS-5(LF) JST
  - BOARD IN BOARD : TD
  - I/F P/B : 7P16, 7EA, BMT08-20G(LF) (SN+TBD)
4. LAMP SOCKET (OR WIRE) SPEC. TBD
5. USER HOLE: ALLOWED DEPTH OF USERHOLE SCREW INSERTION IS 9.0mm MAX.
6. WEIGHT : Max TBD
7. BLACK MATRIX SPEC
  - 1A - B1 ≤ 2.0 mm
  - 1C - D1 ≤ 2.0 mm
8. CHASSIS TOP # PCB GAP SPEC : MAX1.5mm, MAX-MIN=0.7mm

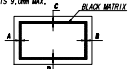

GENERAL TOLERANCE				REV	DATE	DESCRIPTION OF REVISION	REASON	CHK'D BY
STEP	LEVEL 1	LEVEL 2	LEVEL 3	UNIT	mm	DRAWN BY	DES'D BY	CHK'D BY
0 < x ≤ 4	±0.05	±0.1	±0.2	SCALE	IS 5:1/10	J.K./KJM		
4 < x ≤ 16	±0.08	±0.15	±0.3	TOLERANCE		2006.06.19		
16 < x ≤ 64	±0.12	±0.25	±0.5					
64 < x ≤ 256	±0.25	±0.4	±0.8					

PART/SHEET NAME	MODEL NAME	SHEET
OUTLINE DIMENSION	LTA520HT/LTZ520HT	1/2

SPEC. NO.	CODE NO.	VER.
		000

# 7. Outline Dimension (Rear View)

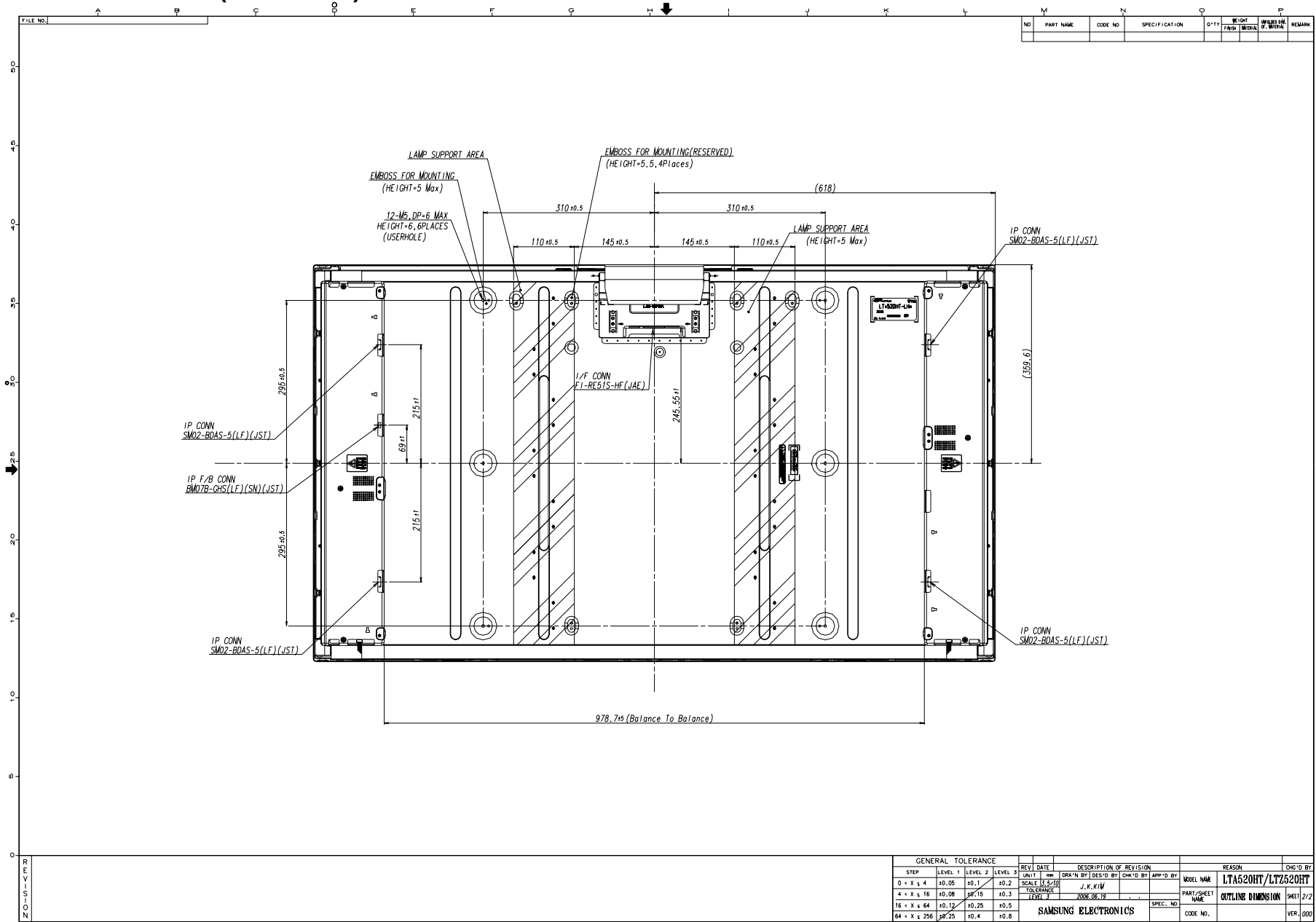

NO	PART NAME	CODE NO	SPECIFICATION	QTY	WEIGHT KGR	VOLUME CM <sup>3</sup>	REMARK

GENERAL TOLERANCE					REV	DATE	DESCRIPTION OF REVISION			REASON		CHK'D BY
STEP	LEVEL 1	LEVEL 2	LEVEL 3	LEVEL 4	UNIT	mm	DRAWN BY	DESIGN BY	CHK'D BY	APP'D BY		
0 < X ≤ 4	±0.05	±0.1	±0.2	±0.3	SCALE	1:1, 2:1	J.K.KIM				MODEL NAME	LTA520HT/LT7520HT
4 < X ≤ 16	±0.08	±0.15	±0.3	±0.5	TOLERANCE						PART/SHEET NAME	OUTLINE DIMENSION SHEET 2/2
16 < X ≤ 64	±0.12	±0.25	±0.5	±0.8	LEVEL 3						SPEC. NO.	
64 < X ≤ 256	±0.25	±0.4	±0.8	±1.2			SAMSUNG ELECTRONICS				CODE NO.	
											VER.	000

## 8. PACKING

### 8.1 CARTON (Internal Package)

(1) Packing Form

Corrugated fiberboard box and corrugated cardboard as shock absorber

(2) Packing Method

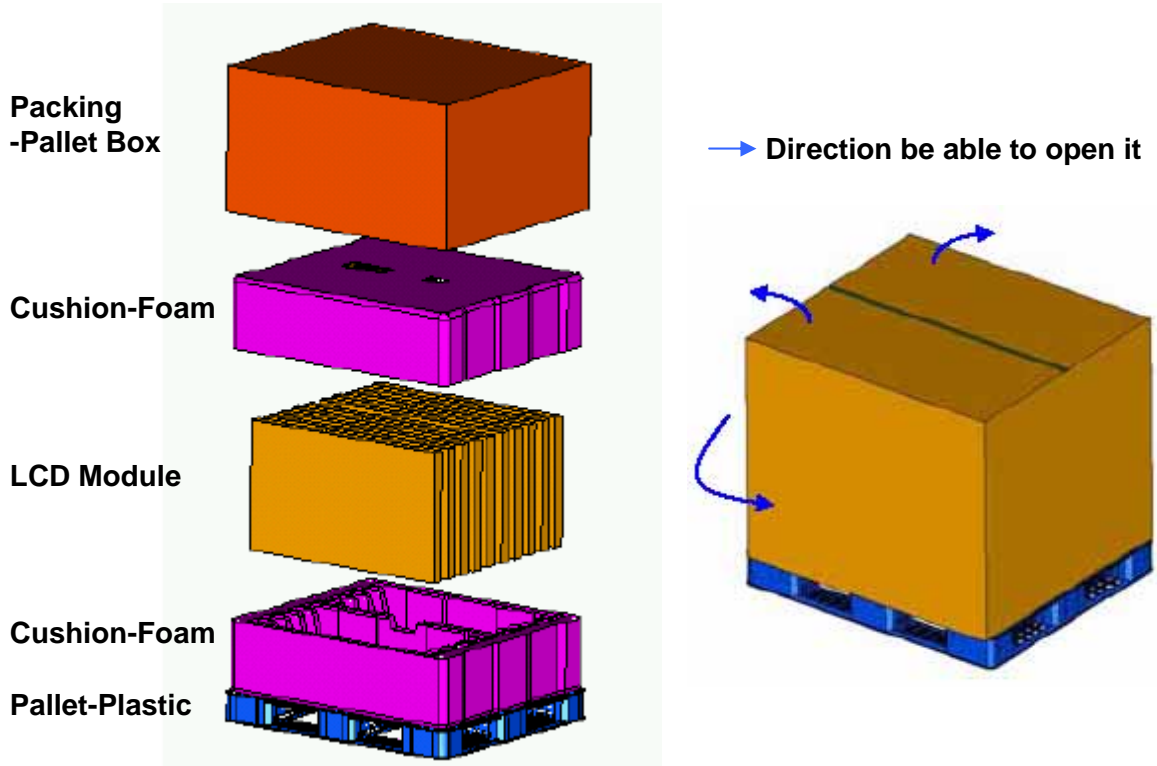

### 8.2 Packing Specification

Item	Specification	Remark
LCD Packing	9ea / (Packing-Pallet Box)	1. 207Kg / LCD (9ea) 2. 15.6 Kg / Cushion-pallet (2ea) 3. 10.5 Kg / Packing-Pallet Box (1ea) 4. Cushion-pallet Material : EPS 5. Packing-Pallet Box Material : DW4
Pallet	1Box / Pallet	1. Pallet weight = 10kg
Packing Direction	Vertical	
Total Pallet Size	H x V x height	1475mm(H) x 1150mm(V) x 995mm(height)
Total Pallet Weight	243.1kg	Pallet(10kg) + Module(23*9=207) + Cushion(up+botton=15.6kg) + Pallet-BOX(10.5kg)



## 9. MARKING & OTHERS

A nameplate bearing followed by is affixed to a shipped product at the specified location on each product.

- (1) Parts number : LTA520HT-LH3
- (2) Revision: Three letters
- (3) Lot number : X X X X XXX XX X

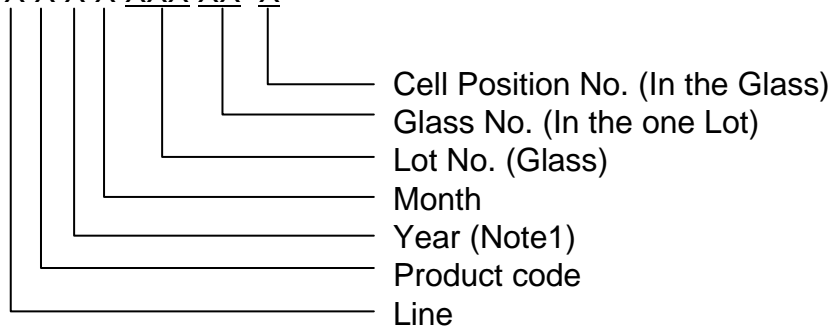

### (4) Nameplate Indication

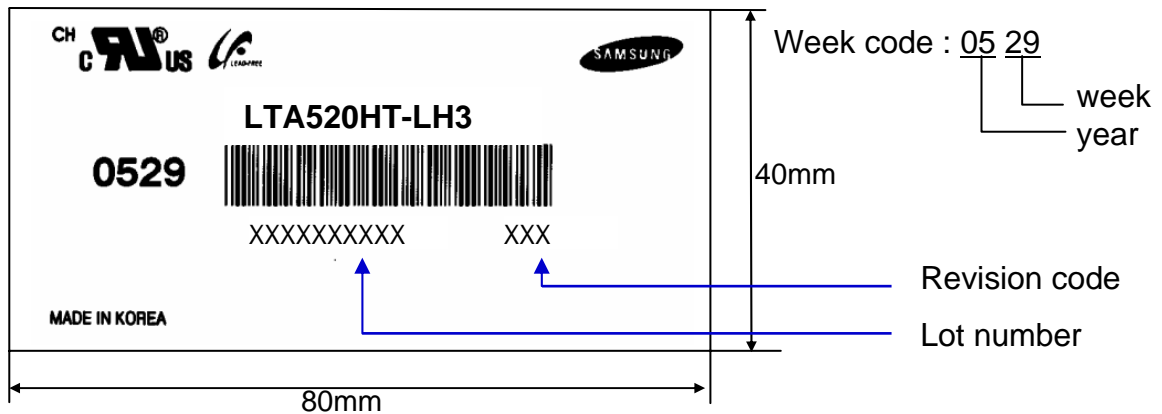

### (5) Packing box attach

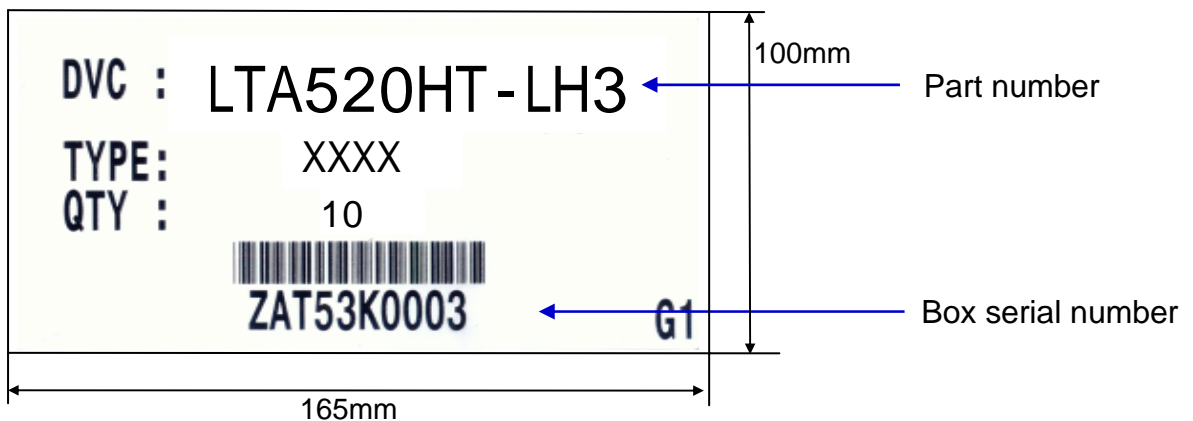

### (6) Others

- 1. After service part

Lamps cannot be replaced because of the narrow bezel structure.

MODEL	LTA520HT-LH3	Doc. No	05-000-G-060818	Page	25 / 28
-------	--------------	---------	-----------------	------	---------

## 10. General Precautions

### 10.1 Handling

- (a) When the Module is assembled, it should be attached to the system firmly using all mounting holes. Be careful not to twist and bend the Module.
- (b) Because the inverter use high voltage, it should be disconnected from power before it is assembled or disassembled.
- (c) Refrain from strong mechanical shock and / or any force to the Module.  
In addition to damage, this may cause improper operation or damage to the Module and CCFT back light.
- (d) Note that polarizers are very fragile and could be damage easily.  
Do not press or scratch the surface harder than a HB pencil lead.
- (e) Wipe off water droplets or oil immediately. If you leave the droplets for a long time, staining or discoloration may occur.
- (f) If the surface of the polarizer is dirty, clean it using absorbent cotton or soft cloth.
- (g) Desirable cleaners are water, IPA(Isopropyl Alcohol) or Hexane.  
Do not use Ketone type materials(ex. Acetone), Ethyl alcohol, Toluene, Ethyl acid or Methyl chloride. It might permanent damage to the polarizer due to chemical reaction.
- (h) If the liquid crystal material leaks from the panel, it should be kept away from the eyes or mouth . In case of contact with hands, legs or clothes, it must be washed away with soap thoroughly.
- (i) Protect the Module from static, or the CMOS Gate Array IC would be damaged.
- (j) Use finger-stalls with soft gloves in order to keep display clean during the incoming inspection and assembly process.
- (k) Do not disassemble the Module.
- (l) Do not pull or fold the lamp wire.
- (m) Do not adjust the variable resistor located on the Module.
- (n) Protection film for polarizer on the Module should be slowly peeled off just before use so that the electrostatic charge can be minimized.
- (o) Pins of I/F connector should not be touched directly with bare hands.

## 10.2 Storage

- (a) Do not leave the Module in high temperature, and high humidity for a long time. It is highly recommended to store the Module with temperature from 0 to 35 and relative humidity of less than 70%.
- (b) Do not store the TFT-LCD Module in direct sunlight.
- (c) The Module should be stored in a dark place. It is prohibited to apply sunlight or fluorescent light in storing.

## 10.3 Operation

- (a) No Connection or disconnect the Module in the "Power On" condition.
- (b) Power supply should always be turned on/off by the "Power on/off sequence"
- (c) Module has high frequency circuits. Sufficient suppression to the electromagnetic interference should be done by system manufacturers. Grounding and shielding methods may be important to minimize the interference.
- (d) The cable between the back light connector and its inverter power supply should be connected directly with a minimized length. A longer cable between the back light and the inverter may cause lower luminance of lamp(CCFT) and may require higher startup voltage(Vs).

## 10.4 Operation Condition Guide

- (a) The LCD product should be operated under normal conditions.  
Normal condition is defined as below;
  - Temperature :  $20 \pm 15$
  - Humidity :  $55 \pm 20\%$
  - Display pattern : continually changing pattern (Not stationary)
- (b) If the product will be used in extreme conditions such as high temperature, humidity, display patterns or operation time etc., It is strongly recommended to contact SEC for Application engineering advice. Otherwise, its reliability and function may not be guaranteed. Extreme conditions are commonly found at Airports, Transit Stations, Banks, Stock market, and Controlling systems.

## 10.5 Others

- (a) Ultra-violet ray filter is necessary for outdoor operation.
- (b) Avoid condensation of water. It may result in improper operation or disconnection of electrode.
- (c) Do not exceed the absolute maximum rating value. ( supply voltage variation, input voltage variation, variation in part contents and environmental temperature, and so on)  
Otherwise the Module may be damaged.
- (d) If the Module keeps displaying the same pattern for a long period of time, the image may be "sticked" to the screen.  
To avoid image sticking, it is recommended to use a screen saver.
- (e) This Module has its circuitry PCB's on the rear side and should be handled carefully in order not to be stressed.
- (f) Please contact SEC in advance when you display the same pattern for a long time.