



# NAN YA PLASTICS CORPORATION

---

SPECIFICATION OF LCD MODULE PRODUCT NO. : LTBGATH04G10CKS_
--

SPEC. NO. : LMH04-10-1

CUSTOMER
APPROVED BY
DATE:

EDITED ON : Dec. 13, 2007

LCD DEPARTMENT  
ELECTRONIC MATERIALS DIVISION  
NAN YA PLASTICS CORPORATION  
201, TUNG HWA N. ROAD, TAIPEI  
TEL:886-2-27122211 EXT. 5993~5995  
FAX:886-2-27178253  
E-mail:lcdsales@npc.com.tw

Q.C. DEPT.	DESIGN MANAGER	DESIGN CHECK	DESIGNER
			M.H.YUAN



NAN YA PLASTICS CORP. ELEC. MATERIALS DIV. LCD DEPARTMENT	SPECIFICATION	SPEC. NO. : LMH04-10 DATE : Nov. 30, 2007 SHEET NO. : 1
---	---------------	---

## 1.MECHANICAL DATA

NO.	ITEM	CONTENTS	UNIT
1	Product No.	LTBGATH04G10CKS_	—
2	Module Size	166.0 (W) x 109.0 (H) x 7.0 (D)	mm
3	Dot Size	0.345 (W) x 0.345 (H)	mm
4	Dot Pitch	0.36 (W) x 0.36 (H)	mm
5	Number of Dots	320 (W) x 240 (H)	Dot
6	Duty	1/240	—
7	LCD Display Mode	FSTN, Normally Black(Negative Image)	—
8	Rear Polarizer	Transmissive Type	—
9	Viewing Direction	6	O'clock
10	Backlight	CCFL	—
11	Controller	Excluded	—
12	DC/DC Converter	Excluded	—
13	Touch Panel	Excluded	—
14	Weight	150 (Approx.)	g

NOTE:

L T B G A T H 0 4 G 10 C K S \_  
 (1) (2) (3) (4) (5) (6) (7) (8)

NO.	ITEM	SYMBOL	DEFINITION
(1)	Backlight	B	CCFL Backlight
(2)	Reflective/Transmissive	T	Transmissive
(3)	Mode/View Angle	G	Normally Black, 6 O'clock
(4)	Option	10	Version
(5)		C	Polarizer with Anti-glare
(6)		K	High Contrast ratio LC
(7)		S	RoHS Compliance
(8)		T	Testing Sample

Nan Ya guarantees that this project doesn't include  
 RoHS Compliance. any materials (6 materials) or includes less than specified  
 quantities which are regulated by RoHS Compliance.

REV/DATE	R0/ 11.30.07'						BY M.H.YUAN
----------	------------------	--	--	--	--	--	----------------

NAN YA PLASTICS CORP. ELEC. MATERIALS DIV. LCD DEPARTMENT	SPECIFICATION	SPEC. NO. : LMH04-10 DATE : Nov. 30, 2007 SHEET NO. : 2
---	---------------	---

## 2.ABSOLUTE MAXIMUM RATINGS

### 2-1.ELECTRICAL ABSOLUTE RATINGS

VSS=0V

ITEM	SYMBOL	MIN.	MAX.	UNIT	COMMENT
Power Supply for Logic	VDD-VSS	-0.3	7.0	V	
Power Supply for LCD Driving	VEE-VSS	0	30.0	V	
Input Voltage	VI	-0.3	VDD	V	
Static Electricity	—	—	—	—	Note 1

Note 1 LCM should be grounded during handling LCM.

### 2-2.ENVIRONMENTAL ABSOLUTE MAXIMUM RATINGS

ITEM	WIDE TEMP.			
	OPERATING		STORAGE	
	MIN.	MAX.	MIN.	MAX.
Ambient Temperature(°C)	-20	70	-40	80
Humidity (Without Condensation)	Note 2,4		Note 3,4	

Note 2  $T_a \leq 70^\circ\text{C}$  : 75%RH MAX.

Note 3 Please refer to item of reliability test.

Note 4 Background color will change slightly depending on ambient temperature.  
That phenomenon is reversible.

Note 5 Operation temp not include CCFL Lamp.

REV/DATE	R0/ 11.30.07'						BY M.H.YUAN
----------	------------------	--	--	--	--	--	----------------

NAN YA PLASTICS CORP. ELEC. MATERIALS DIV. LCD DEPARTMENT	SPECIFICATION	SPEC. NO. : LMH04-10 DATE : Nov. 30, 2007 SHEET NO. : 3-1
---	---------------	---

### 3.ELECTRICAL CHARACTERISTICS

#### 3-1.ELECTRICAL CHARACTERISTICS OF LCM

ITEM	SYMBOL	CONDITION	MIN.	TYP.	MAX.	UNIT	
Power Supply for Logic	VDD-VSS	—	4.5	5.0	5.5	V	
Input Voltage	VIH	H Level	0.8VDD	—	VDD	V	
	VIL	L Level	0	—	0.2VDD		
Recommended LC Driving Voltage	VEE-VSS	Duty = 1/240	-20°C	22.3	22.8	23.3	V
			0°C	22.1	22.6	23.1	
			25°C	21.4	21.9	22.4	
			50°C	20.6	21.1	21.6	
			70°C	20.1	20.6	21.1	
Power Supply Current (Ta=25°C)	IDD	VDD-VSS=5.0V VEE-VSS=21.9V FLM=70HZ	—	2.5	5.0	mA	
	IEE	Pattern: 	—	5.0	7.5		
LCM Surface Luminance (Ta=25°C)	L	VDD-VSS = 5.0V VEE-VSS=21.9V IL=5mA	Dots All Off	—	30	—	cd/m <sup>2</sup>
			Dots All On	100	150	—	

REV/DATE	R0/ 11.30.07'	R1/ 12.13.07'					BY M.H.YUAN
----------	------------------	------------------	--	--	--	--	----------------

NAN YA PLASTICS CORP. ELEC. MATERIALS DIV. LCD DEPARTMENT	SPECIFICATION	SPEC. NO. : LMH04-10 DATE : Nov. 30, 2007 SHEET NO. : 3-2
---	---------------	---

### 3-2.ELECTRICAL CHARACTERISTICS OF BACKLIGH

Used Lamp Rating

Ta=25°C

ITEM	SYMBOL	MIN.	TYP.	MAX.	UNIT	REMARK
Lamp Voltage	VL	—	301	—	Vrms	—
Lamp Current	IL	3	5	6	mArms	—
Lamp Power Consumption	PL	—	1.51	—	W	(*1)
Starting Voltage	VS	—	—	850	Vrms	Ta=25°C
		—	—	1110	Vrms	Ta=0°C
Lamp life time	LL	20000	—	—	Hrs	at IL=5 mArms Ta=25°C(*2)

(\*1) Power consumption excluded inverter loss.

(\*2) Lamp life time is defined as follows : The final brightness is at 50% of original brightness.

(\*3) a. Please follow the table of lamp characteristics shown above if not to use the inverter tested by Nan Ya.  
 b. If customers want to design inverter by themselves, please inform Nan Ya to offer the detail lamp specification.

REV/DATE	R0/ 11.30.07'							BY	M.H.YUAN
----------	------------------	--	--	--	--	--	--	----	----------

NAN YA PLASTICS CORP. ELEC. MATERIALS DIV. LCD DEPARTMENT	<b>SPECIFICATION</b>	SPEC. NO. : LMH04-10 DATE : Nov. 30, 2007 SHEET NO. : 3-3
---	----------------------	---

### 3-3.ELECTRICAL CHARACTERISTICS OF TESTED INVERTER

TDK CXA-M10L-L

( If the inverter output "CN2" couldn't mating CCFL connector, please refer to specification "INTERNAL PIN CONNECTION" page to fit it.)

#### 3-3-1 GENERAL SPECIFICATIONS

OPERATION TEMPERATURE : -10°C ~60°C

STORAGE TEMPERATURE : -20°C ~85°C

DIMENSION : 56.0(L)mm x 29.0(W)mm x MAX. 19.5(H)mm

#### 3-3-2 PIN ASSIGNMENTS

INPUT(CN1) CONNECTOR :

OUTPUT(CN2) CONNECTOR :

NO.	FUNCTION
1	VIN
2	GND

NO.	FUNCTION
3	OUT1
4	OUT2
5	OUT GND

#### 3-3-3 RELATIONSHIP BETWEEN VIN & TUBE CURRENT

ITEM	SYMBOL	MIN.	TYP.	MAX.	UNIT	REMARK
Input Voltage	VIN	—	10.8	—	V	
Tube Current	IL	—	5	—	mA	

REV/DATE	R0/ 11.30.07'							BY	M.H.YUAN
----------	------------------	--	--	--	--	--	--	----	----------

NAN YA PLASTICS CORP. ELEC. MATERIALS DIV. LCD DEPARTMENT	SPECIFICATION	SPEC. NO. : LMH04-10 DATE : Nov. 30, 2007 SHEET NO. : 4-1
---	---------------	---

## 4.OPTICAL CHARACTERISTICS

4-1.Optical Char. of Wide Temp. Mode

at Vop

ITEM		Cr(Contrast Ratio)										$\theta$ (Viewing Angle)		$\varphi$ (Viewing Angle)	
		-20℃		0℃		25℃		50℃		70℃		25℃		25℃	
MODE		MIN.	TYP.	MIN.	TYP.	MIN.	TYP.	MIN.	TYP.	MIN.	TYP.	Viewing Direction	TYP.	Viewing Direction	TYP.
		T	G	8	12	10	15	14	20	6	8	2	3	6 O'Clock	40
												12 O'Clock	30	3 O'Clock	35
NOTE		NOTE 3,6										NOTE 3,5			

NOTE :

T : Transmissive

G : Normally Black, 6 O'clock

at  $\varphi = 0^\circ, \theta = 0^\circ$

ITEM	SYMBOL	CONDITION	MIN.	TYP.	MAX.	UNIT	NOTE
Response Time (rise)	Tr	-20℃	2100	2650	4000	ms	NOTE 2,3
		0℃	550	700	1050		
		25℃	280	350	520		
		50℃	150	190	280		
		70℃	90	110	160		
Response Time (fall)	Tf	-20℃	1200	1500	2200	ms	NOTE 2,3
		0℃	400	500	750		
		25℃	120	150	220		
		50℃	70	90	140		
		70℃	60	70	100		

REV/DATE	R0/ 11.30.07'						BY M.H.YUAN
----------	------------------	--	--	--	--	--	----------------



(NOTE 1)

Definition of Operation Voltage(Vop)

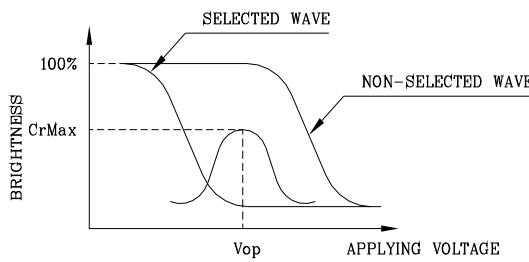

(positive type)

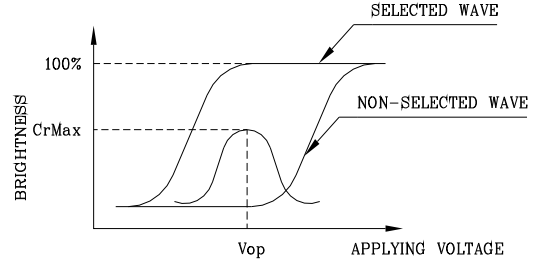

(negative type)

\*Conditions

Viewing Angle : 0  
Frame Frequency : 70Hz  
Applying Waveform : 1/N duty 1/a bias

(NOTE 2)

Definition of Response Time(Tr,Tf)

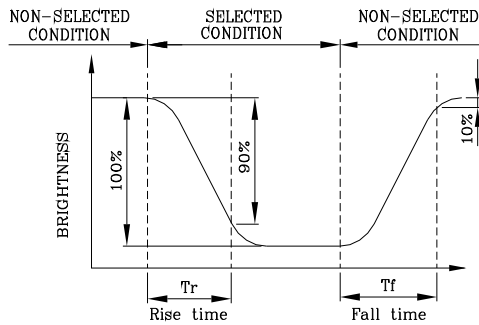

(positive type)

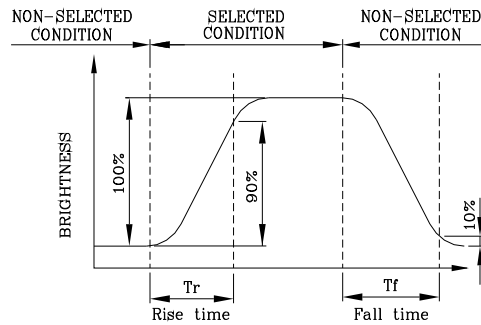

(negative type)

\*Conditions

Operating Voltage : Vop  
Viewing Angle (θ,φ) : (0,0)  
Frame Frequency : 70Hz  
Applying Waveform : 1/N duty 1/a bias

(NOTE 3)

Description of Measuring Equipment and Driving Waveforms

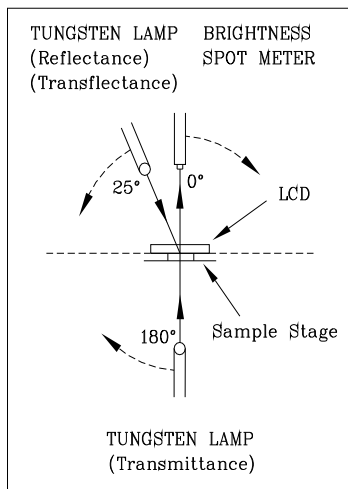

CONST.  
TEMP.  
CHAMBER

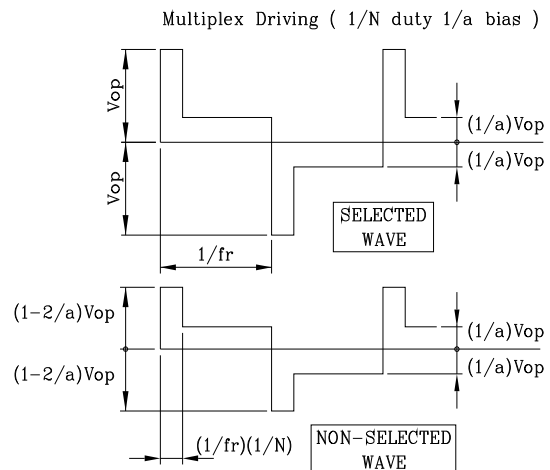

(NOTE 4)

Definition of Viewing Direction

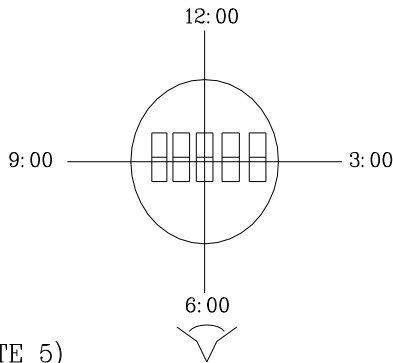

(NOTE 5)

Definition of Viewing Angle

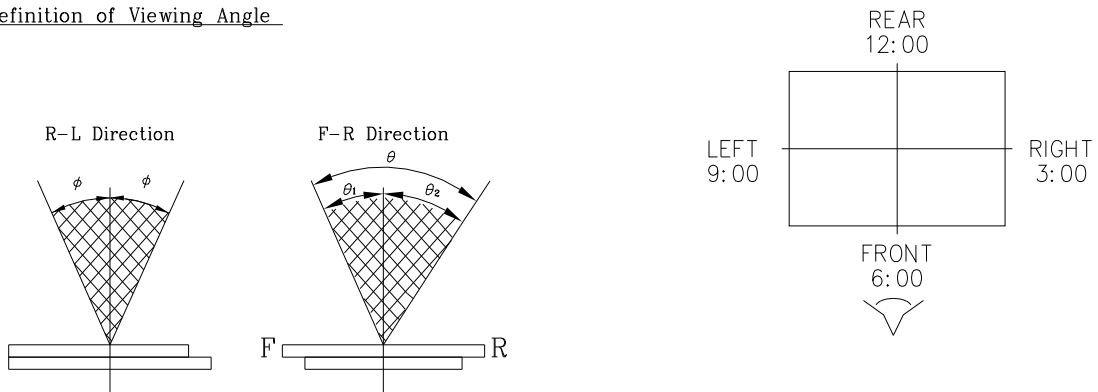

$$\theta = \theta_1 + \theta_2$$

\*Conditions

Operating Voltage :  $V_{op}$   
 Frame Frequency : 70Hz  
 Applying Waveform : 1/N duty 1/a bias  
 Contrast Ratio : larger than 2

(NOTE 6)

Definition of Contrast Ratio (Cr)

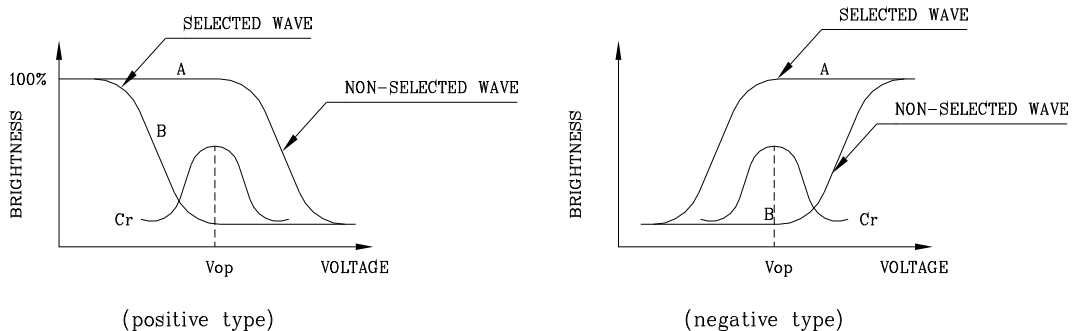

Contrast Ratio :  $Cr = A/B$

\*Conditions

Viewing Angle : 0  
 Frame Frequency : 70Hz  
 Applying Waveform : 1/N duty 1/a bias

REV/DATE	R0/ 11.30.07'						BY M.H.YUAN
----------	------------------	--	--	--	--	--	----------------

5. BLOCK DIAGRAM

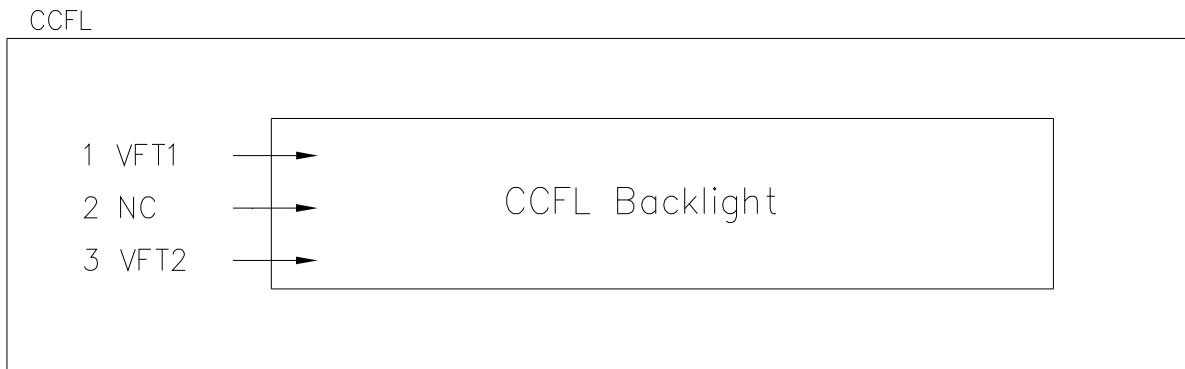
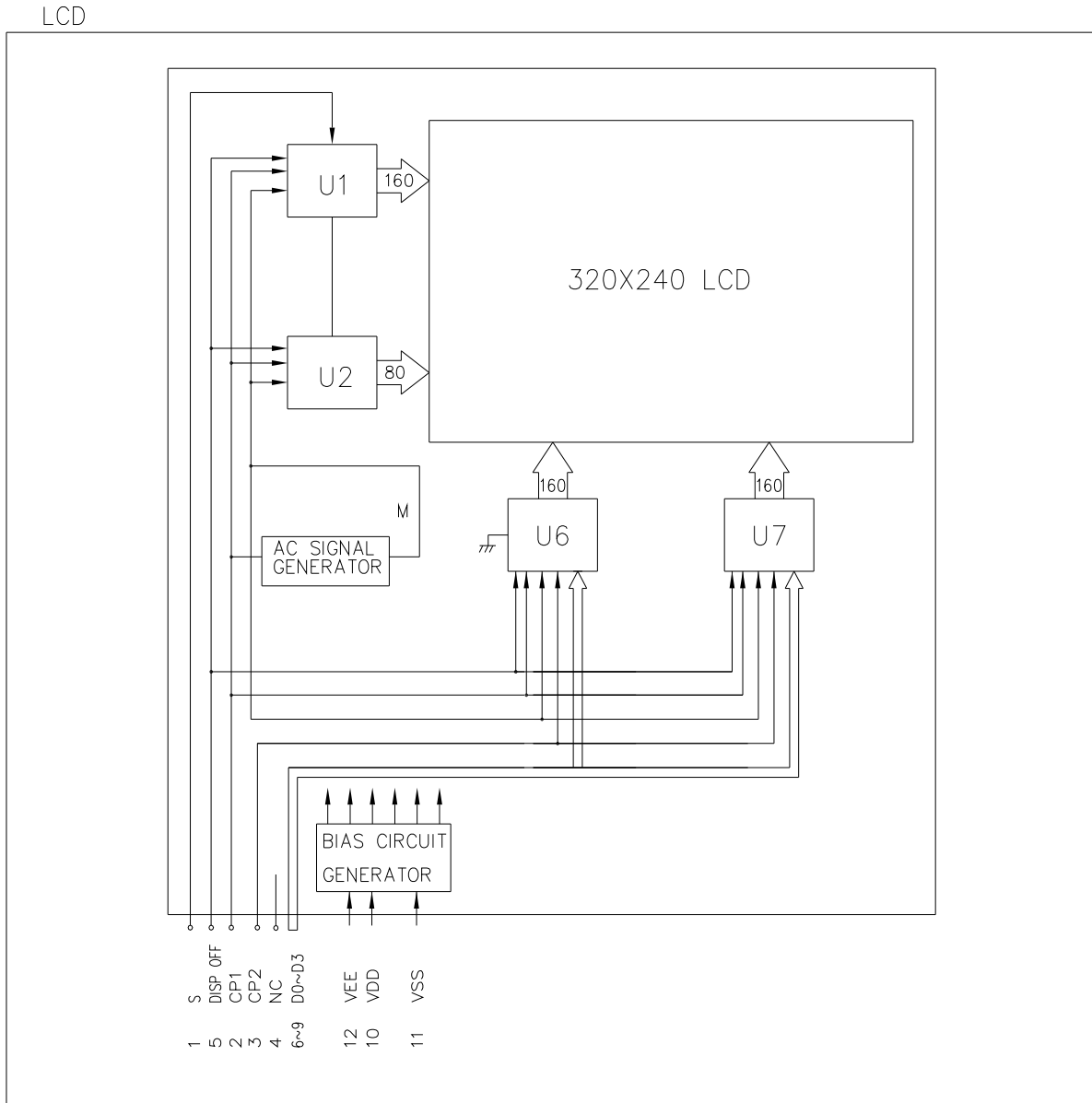

## 6.INTERNAL PIN CONNECTION

### LCD

Pin No.	Symbol	Function
1	S	Scan start-up signal
2	CP1	Input data latch signal
3	CP2	Data input clock signal
4	NC	-
5	DISP OFF	Display control signal
6	D0	Display data signal
7	D1	Display data signal
8	D2	Display data signal
9	D3	Display data signal
10	VDD	Power supply for logic
11	VSS	Ground potential
12	VEE	Power supply for LCD drive

Used connector : FFC , P1.25mm N=12

Recommended connector : 00 6207 33 20 12 000+ (ELCO) or COMPATIBLE

### CCFL

Pin No.	Symbol	Function
1	VFT1	Power supply for CCFT back light (HOT)
2	NC	-
3	VFT2	Power supply for CCFT back light (GND)

Used connector : XHP-3 (JST)

Mating connector : BH 3B-XH-2 (JST) or COMPATIBLE

REV/DATE	R0/ 11.30.07'						BY M.H.YUAN
----------	------------------	--	--	--	--	--	----------------

7.POWER SUPPLY

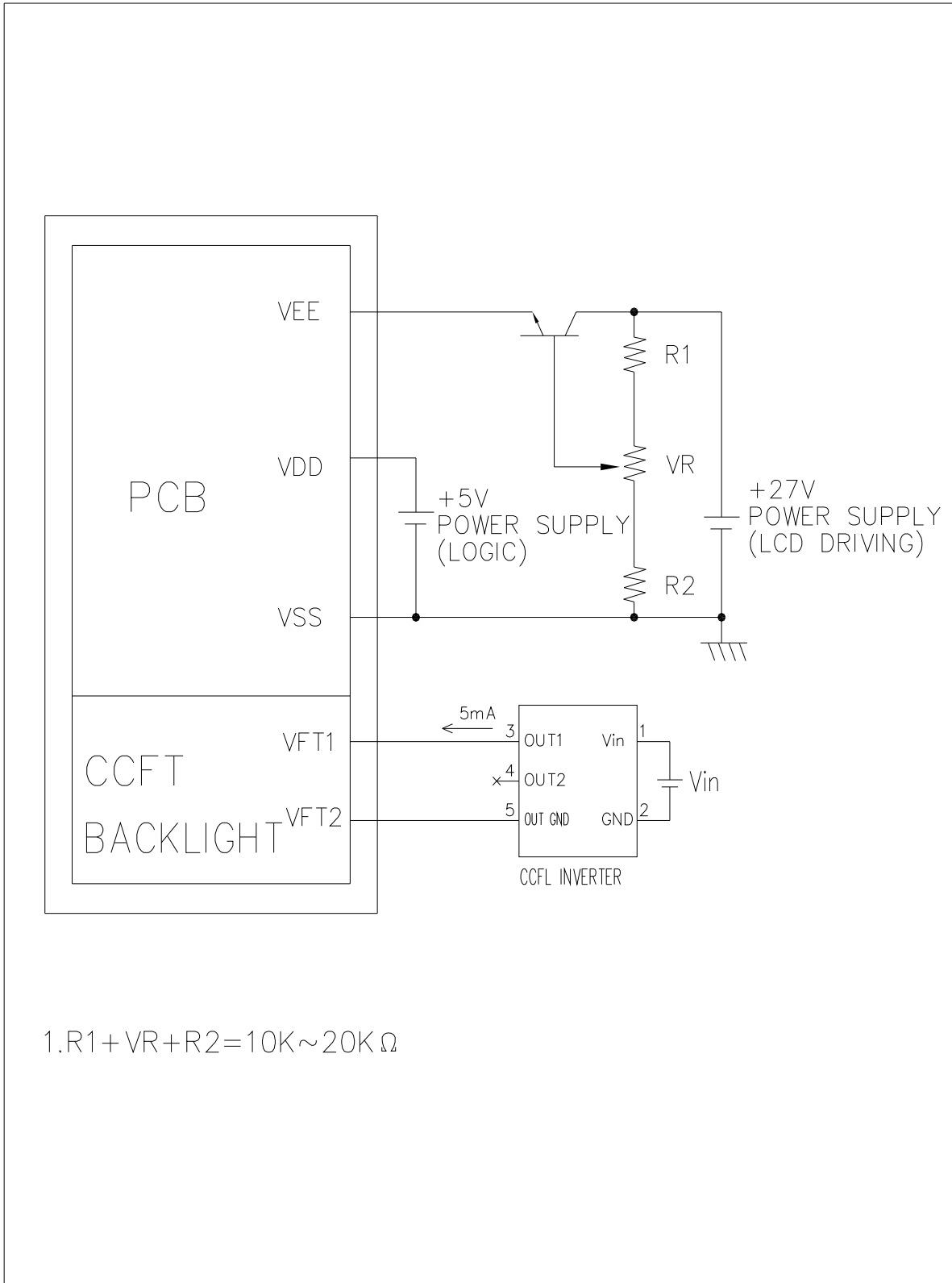

1.  $R1 + VR + R2 = 10K \sim 20K \Omega$

## 8.TIMING CHARACTERISTICS

### 8-1.INTERFACE TIMING

@VDD=2.5~5.5V

ITEM	SYMBOL	MIN.	TYP.	MAX.	UNIT
Shift Clock Period	$t_{cp}$	125	-	-	ns
"CP2" PULSE WIDTH	$t_w$	51	-	-	ns
CLOCK RISE, FALL TIME	$t_r, t_f$	-	-	20	ns
DATA SETUP TIME	$t_{dsu}$	40	-	-	ns
DATA HOLD TIME	$t_{dhd}$	30	-	-	ns
"CP2" → "CP1" FALL TIME	$t_{lsu}$	51	-	-	ns
"CP1" → "CP2" FALL TIME	$t_{lc}$	51	-	-	ns
"S" SETUP TIME	$t_{setup}$	30	-	-	ns
"S" HOLD TIME	$t_{hold}$	50	-	-	ns
"CP1" PULSE WIDTH	$t_{wc}$	51	-	-	ns

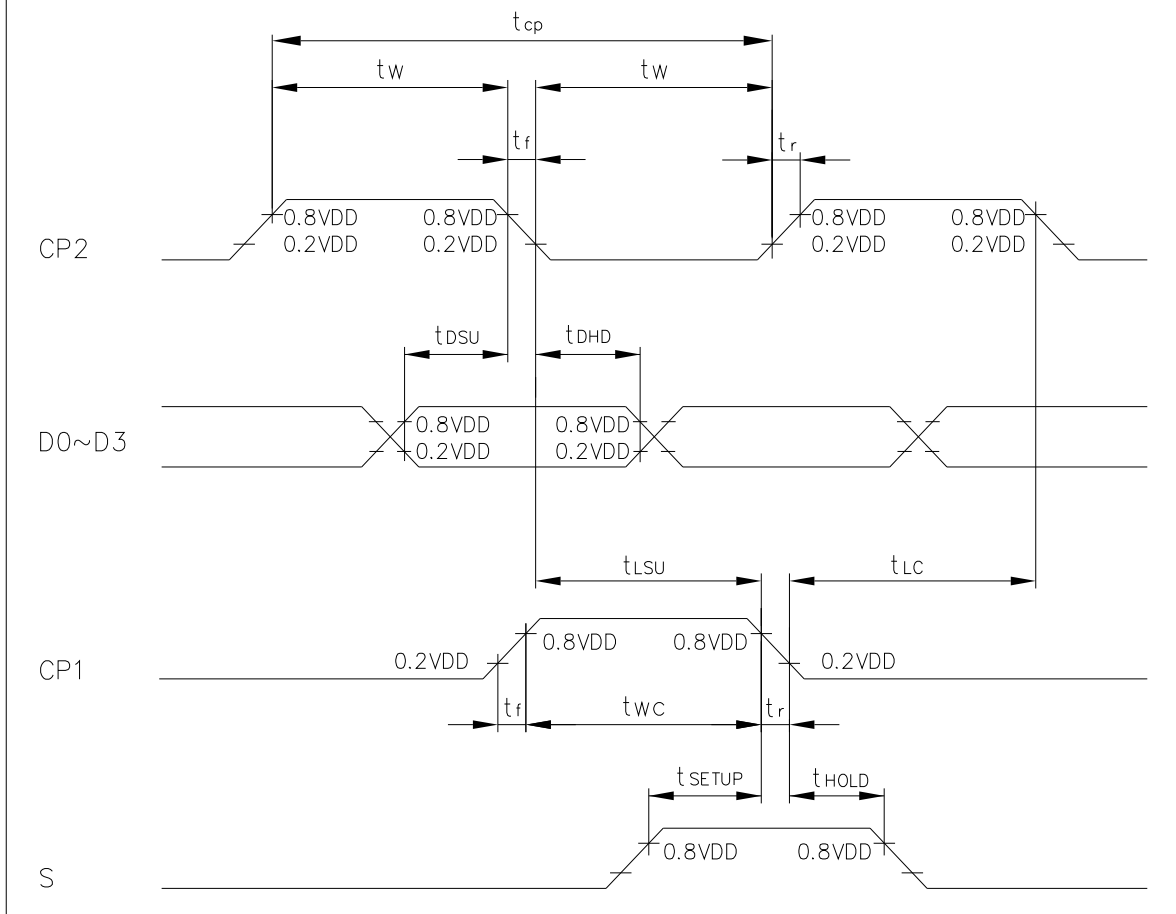

8-2.POWER ON/OFF TIMING

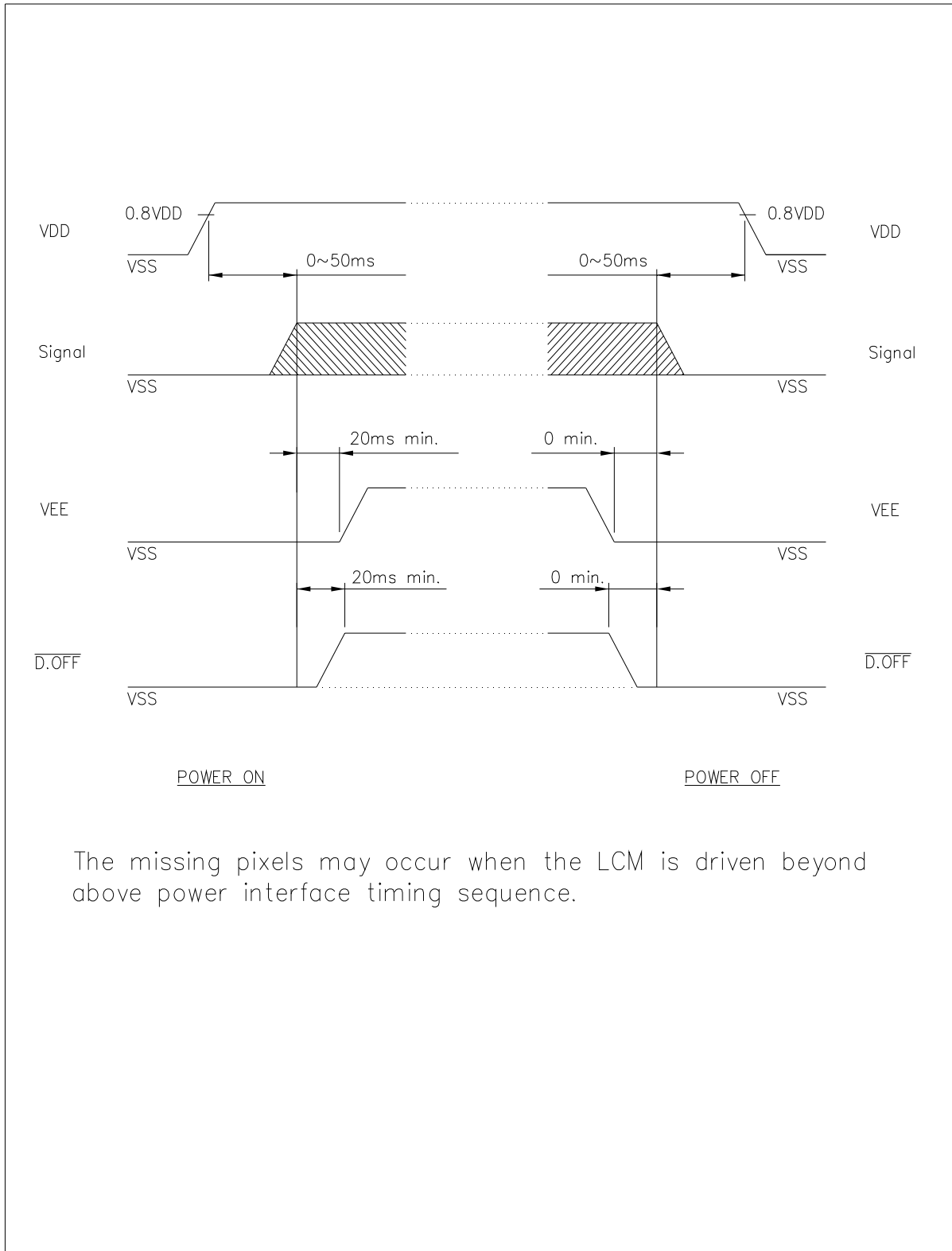

The missing pixels may occur when the LCM is driven beyond above power interface timing sequence.

REV/DATE	R0/ 11.30.07'						BY M.H.YUAN
----------	------------------	--	--	--	--	--	----------------





NAN YA PLASTICS CORP. ELEC. MATERIALS DIV. LCD DEPARTMENT	SPECIFICATION	SPEC. NO. :    LMH04-10 DATE :         Nov. 30, 2007 SHEET NO. :    9-1
---	---------------	---

## 9.RELIABILITY TEST

### WIDE TEMPERATURE RELIABILITY TEST

NO.	ITEM	CONDITION			STANDARD	NOTE
1	High Temp. Storage	80 °C	120 Hrs		Appearance without defect	
2	Low Temp. Storage	-30 °C	120 Hrs		Appearance without defect	
3	High Temp. & High Humi. Storage	60 °C 90%RH	120 Hrs		Appearance without defect	
4	High Temp. Operating Display	70 °C	120 Hrs		Appearance without defect	
5	Low Temp. Operating Display	-20 °C	120 Hrs		Appearance without defect	
6	Thermal Shock	-20 °C, 30min. → 70°C, 30min. ↑ (1cycle)			Appearance without defect	10 cycles

REV/DATE	R0/ 11.30.07'							BY	M.H.YUAN
----------	------------------	--	--	--	--	--	--	----	----------

NAN YA PLASTICS CORP. ELEC. MATERIALS DIV. LCD DEPARTMENT	<b>SPECIFICATION</b>	SPEC. NO. :    LMH04-10 DATE :         Nov. 30, 2007 SHEET NO. :    9-2
---	----------------------	---

Inspection Provision

1.Purpose

The NAN YA inspection provision provides outgoing inspection provision and its expected quality level based on our outgoing inspection of NAN YA LCD produces.

2.Applicable Scope

The NAN YA inspection provision is applicable to the arrangement in regard to outgoing inspection and quality assurance after outgoing.

3.Technical Terms

3-1 NAN YA Technical Terms



4.Outgoing Inspection

4-1 Inspection Method

MIL-STD-105E Level II Regular inspection

4-2 Inspection Standard

	Item		AQL(%)	Remarks
Major Defect	Dots	Opens	0.4	faults which substantially lower the practicality and the initial purpose difficult to achieve.
		Shorts		
	Erroneous operation			
Solder appearance	Shorts	0.4		
	Loose			
Cracks	Display surface cracks	0.4		

REV/DATE	R0/ 11.30.07'							BY	M.H.YUAN
----------	------------------	--	--	--	--	--	--	----	----------

NAN YA PLASTICS CORP. ELEC. MATERIALS DIV. LCD DEPARTMENT	<b>SPECIFICATION</b>	SPEC. NO. : LMH04-10 DATE : Nov. 30, 2007 SHEET NO. : 9-3
---	----------------------	---

	Dimensions	External from Dimensions	0.4	
Minor Defect	Inside the glass	Black spots	0.65	faults which appear to pose almost no obstacle to the practicality, effective use, and operation.
	Polarizing plate	Scratches, foreign Matter, air bubbles, and peeling		
	Dots	Pinhole, deformation		
	Color tone	Color unevenness		
	Solder appearance	Cold solder Solder projections		

4-3 Inspection Provisions

\*Viewing Area Definition

Fig. 1

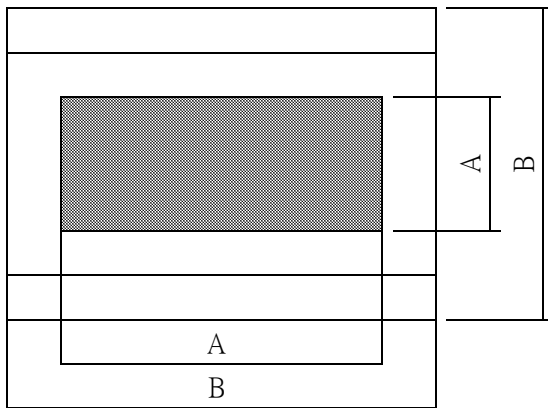

A : Zone Viewing Area  
 B : Zone Glass Plate Outline

\*Inspection place to be 500 to 1000 lux illuminance uniformly without glaring.  
 The distance between luminous source(daylight fluorescent lamp and cool white fluorescent lamp) and sample to be 30 cm to 50 cm.

REV/DATE	R0/ 11.30.07'							BY	M.H.YUAN
----------	------------------	--	--	--	--	--	--	----	----------

NAN YA PLASTICS CORP. ELEC. MATERIALS DIV. LCD DEPARTMENT	SPECIFICATION	SPEC. NO. :    LMH04-10 DATE :         Nov. 30, 2007 SHEET NO. :    9-4
---	---------------	---

\*Test and measurement are performed under the following conditions, unless otherwise specified.

Temperature         $20 \pm 15^{\circ}\text{C}$   
 Humidity             $65 \pm 20\%\text{R.H.}$   
 Pressure             860~1060hPa(mmbar)

In case of doubtful judgment, it is performed under the following conditions.

Temperature         $20 \pm 2^{\circ}\text{C}$   
 Humidity             $65 \pm 5\%\text{R.H.}$   
 Pressure             860~1060hPa(mmbar)

5.Specification for quality check

5-1 Electrical characteristics

NO.	Item	Criterion
1	Non operational	Fail
2	Miss operating	Fail
3	Missing dot	Fail
4	Contrast irregular	Fail
5	Response time	Within Specified value
6	Backlight turn on/off	Within Specified value

REV/DATE	R0/ 11.30.07'							BY	M.H.YUAN
----------	------------------	--	--	--	--	--	--	----	----------

SPECIFICATION

5-2 External Appearance Defect

NO.	Item	Criterion																							
1	Black spots, foreign matter, and white spots (Including light leakage due to pinholes of polarizing plates, etc.)	<p>(1)-1-Spots</p> <table border="1" data-bbox="812 600 1353 911"> <thead> <tr> <th>Average Diameter (mm):D</th> <th>Number of pieces permitted</th> <th>Minimum Space</th> </tr> </thead> <tbody> <tr> <td><math>D \leq 0.2</math></td> <td>Ignore</td> <td>—</td> </tr> <tr> <td><math>0.2 &lt; D \leq 0.3</math></td> <td>5</td> <td>10mm</td> </tr> <tr> <td><math>0.3 &lt; D \leq 0.4</math></td> <td>2</td> <td>30mm</td> </tr> <tr> <td><math>0.4 &lt; D</math></td> <td>0</td> <td>—</td> </tr> </tbody> </table> <p>Number of total pieces is set to within 5 pieces.</p> <p>Note that when there are 2 pieces or more, they are not to be concentrated. Set as: Average diameter = (Long diameter + Short diameter)/2</p> <p>(1)-2-Blurred Spots(At lighting condition)</p> <table border="1" data-bbox="812 1265 1353 1487"> <thead> <tr> <th>Average Diameter (mm):D</th> <th>Number of pieces permitted</th> </tr> </thead> <tbody> <tr> <td><math>D \leq 0.3</math></td> <td>Ignore</td> </tr> <tr> <td><math>0.3 &lt; D \leq 0.75</math></td> <td>5</td> </tr> <tr> <td><math>0.75 &lt; D</math></td> <td>0</td> </tr> </tbody> </table> <p>Number of total pieces is set to within 5 pieces.</p> <p>Note that when there are 2 pieces or more, they are not to be concentrated. Set as: Average diameter = (Long diameter + Short diameter)/2</p>	Average Diameter (mm):D	Number of pieces permitted	Minimum Space	$D \leq 0.2$	Ignore	—	$0.2 < D \leq 0.3$	5	10mm	$0.3 < D \leq 0.4$	2	30mm	$0.4 < D$	0	—	Average Diameter (mm):D	Number of pieces permitted	$D \leq 0.3$	Ignore	$0.3 < D \leq 0.75$	5	$0.75 < D$	0
Average Diameter (mm):D	Number of pieces permitted	Minimum Space																							
$D \leq 0.2$	Ignore	—																							
$0.2 < D \leq 0.3$	5	10mm																							
$0.3 < D \leq 0.4$	2	30mm																							
$0.4 < D$	0	—																							
Average Diameter (mm):D	Number of pieces permitted																								
$D \leq 0.3$	Ignore																								
$0.3 < D \leq 0.75$	5																								
$0.75 < D$	0																								

SPECIFICATION

1	Line	<p>(1)-1-Lines</p> <table border="1" data-bbox="813 465 1353 734"> <thead> <tr> <th>Width(mm):W</th> <th>Length(mm): L</th> <th>Number of pieces permitted</th> </tr> </thead> <tbody> <tr> <td><math>W \leq 0.03</math></td> <td>Ignore</td> <td>Ignore</td> </tr> <tr> <td><math>0.03 &lt; W \leq 0.08</math></td> <td><math>L \leq 4</math></td> <td>2</td> </tr> <tr> <td><math>0.08 &lt; W \leq 0.1</math></td> <td><math>L \leq 1</math></td> <td>1</td> </tr> </tbody> </table> <p>Object exceeding 0.1mm follow the standards of the spots form. Note that when there are 2 pieces or more, they are not to be concentrated.</p> <p>(1)-2-Blurred Lines(At lighting condition)</p> <table border="1" data-bbox="813 999 1353 1267"> <thead> <tr> <th>Width(mm):W</th> <th>Length(mm): L</th> <th>Number of pieces permitted</th> </tr> </thead> <tbody> <tr> <td><math>W \leq 0.03</math></td> <td>Ignore</td> <td>Ignore</td> </tr> <tr> <td><math>0.03 &lt; W \leq 0.08</math></td> <td><math>L \leq 3</math></td> <td>6</td> </tr> <tr> <td><math>0.08 &lt; W</math></td> <td><math>3 &lt; L</math></td> <td>None</td> </tr> </tbody> </table> <p>Object exceeding 0.1mm follow the standards of the spots form. Note that when there are 2 pieces or more, they are not to be concentrated.</p>	Width(mm):W	Length(mm): L	Number of pieces permitted	$W \leq 0.03$	Ignore	Ignore	$0.03 < W \leq 0.08$	$L \leq 4$	2	$0.08 < W \leq 0.1$	$L \leq 1$	1	Width(mm):W	Length(mm): L	Number of pieces permitted	$W \leq 0.03$	Ignore	Ignore	$0.03 < W \leq 0.08$	$L \leq 3$	6	$0.08 < W$	$3 < L$	None
Width(mm):W	Length(mm): L	Number of pieces permitted																								
$W \leq 0.03$	Ignore	Ignore																								
$0.03 < W \leq 0.08$	$L \leq 4$	2																								
$0.08 < W \leq 0.1$	$L \leq 1$	1																								
Width(mm):W	Length(mm): L	Number of pieces permitted																								
$W \leq 0.03$	Ignore	Ignore																								
$0.03 < W \leq 0.08$	$L \leq 3$	6																								
$0.08 < W$	$3 < L$	None																								
2	Scratches(Glass, reflection plates, and polarizing plates)	In accordance with black spots. (At non lighting condition)																								
3	Color irregular	Not remarkable color irregular.																								

SPECIFICATION

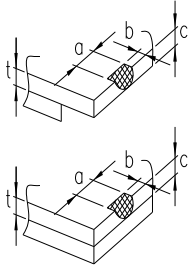
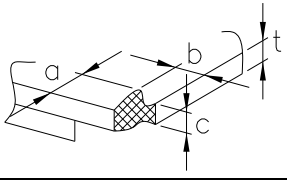
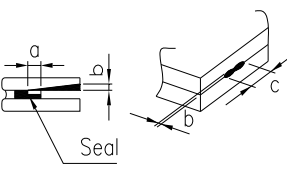
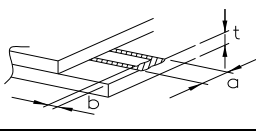
4	Air bubbles polarizing plates, and reflection plates	<table border="1" data-bbox="810 421 1193 645"> <thead> <tr> <th>Average Diameter (mm):D</th> <th>Number of pieces permitted</th> </tr> </thead> <tbody> <tr> <td><math>D \leq 0.3</math></td> <td>Ignore</td> </tr> <tr> <td><math>0.3 &lt; D</math></td> <td>0</td> </tr> </tbody> </table> <p data-bbox="1193 443 1369 627">Average diameter = (Long diameter + Short diameter)/2</p> <p data-bbox="813 658 1372 725">Note that when there are 4 pieces or more, they are not to be concentrated.</p>		Average Diameter (mm):D	Number of pieces permitted	$D \leq 0.3$	Ignore	$0.3 < D$	0
Average Diameter (mm):D	Number of pieces permitted								
$D \leq 0.3$	Ignore								
$0.3 < D$	0								
5	Cracks	<p>(1)General crack</p> 	<p><math>a \leq 5</math>  <math>b \leq 2</math>  <math>c \leq t</math></p> <p>Where, a and b are ignored when less than or equal to 0.5 . The numbers of pieces are set at up to 5 pieces.</p>						
		<p>(2)Corner crack</p> 	<p><math>a \leq 2.5</math>  <math>b \leq 2.5</math>  <math>c \leq t</math>  <math>a+b \leq 4</math></p>						
		<p>(3)Seal portion crack</p> 	<p><math>a \leq \text{The seal width} \times 1/3</math>  <math>b \leq t \times 2/3</math>  <math>c \leq 5</math></p> <p>The numbers of pieces are set at up to 5 pieces.</p>						
		<p>(4)ITO Pin crack</p> 	<p><math>a \leq 5</math>  <math>b \leq 1/3 \text{ pin length}</math>  <math>c \leq t</math></p>						
		<p>(5)Progressive cracks</p>	<p>All taken to be unacceptable.</p>						

NAN YA PLASTICS CORP. ELEC. MATERIALS DIV. LCD DEPARTMENT	<b>SPECIFICATION</b>	SPEC. NO. : LMH04-10 DATE : Nov. 30, 2007 SHEET NO. : 9-8
---	----------------------	---

6	Outer dimensions	Should be within the tolerance.
7	Newton ring(touch panel)	Orbicular of interference fringes is not allowed in the optimum contrast within the active area under viewing angle.
8	Soldering	Should be no defective soldering such as shorting, loose terminal cold solder, peeling of printed circuit board pattern, improper mounting position, etc.

5-3 Dot Appearance Defect

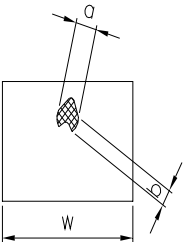
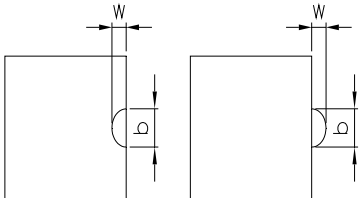
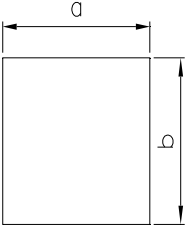
NO.	Item	Criteria
1	Pinhole	 <p>Dot display a and b are each <math>\leq 0.2\text{mm}</math>. The overall total is taken be with in 10 units. Note that they are not to be concentrated.</p>
2	Missing	 <p>Dot display a and b are each <math>\leq 0.2\text{mm}</math>. The overall total is taken to be with in 10 units.</p>
3	Thick and thin display	 <p>Taken to be within <math>\pm 1.5\%</math> of display character width(a) and height(b).</p>

REV/DATE	R0/ 11.30.07'							BY	M.H.YUAN
----------	------------------	--	--	--	--	--	--	----	----------



NAN YA PLASTICS CORP. ELEC. MATERIALS DIV. LCD DEPARTMENT	<b>SPECIFICATION</b>	SPEC. NO. :     LMH04-10 DATE :            Nov. 30, 2007 SHEET NO. :     9-9
---	----------------------	--

NOTICE:

- SAFETY

1. If the LCD panel breaks, be careful not to get the liquid crystal to touch your skin.
2. If the liquid crystal touches your skin or clothes, please wash it off immediately by using soap and water.

- HANDLING

1. Avoid static electricity which can damage the CMOS LSI.
2. Do not remove the panel or frame from the module.
3. The polarizing plate of the display is very fragile. So, please handle it very carefully.
4. Do not wipe the polarizing plate with a dry cloth, as it may easily scratch the surface of plate.
5. Do not use ketonics solvent & Aromatic solvent. Use a soft cloth soaked with a cleaning naphtha solvent.

- STORAGE

1. Store the panel or module in a dark place where the temperature is  $25\pm 5^{\circ}\text{C}$  and the humidity is below 65% RH.
2. Do not place the module near organics solvents or corrosive gases.
3. Do not crush, shake, or jolt the module.

- TERMS OF WARRANT

1. Acceptance inspection period  
The period is within one month after the arrival of contracted commodity at the buyer's factory site.
2. Applicable warrant period  
The period is within twelve months since the date of shipping out under normal using and storage conditions.

REV/DATE	R0/ 11.30.07'							BY	M.H.YUAN
----------	------------------	--	--	--	--	--	--	----	----------

10.OUTLINE DRAWING

