

Linear Phase 8th Order Lowpass Filter

FEATURES

- 8th Order, Linear Phase Filter in SO-8 Package
- Raised Cosine Amplitude Response
- -43dB Attenuation at $2 \times f_{\text{CUTOFF}}$
- Wideband Noise: $140\mu\text{V}_{\text{RMS}}$
- Operates from Single 5V Supply to $\pm 5\text{V}$ Power Supplies
- Clock-Tunable to 200kHz with $\pm 5\text{V}$ Supplies
- Clock-Tunable to 120kHz with Single 5V Supply

APPLICATIONS

- Digital Communication Filter
- Antialiasing Filter with Linear Phase
- Smoothing Filters

DESCRIPTION

The LTC[®]1069-7 is a monolithic, clock-tunable, linear phase, 8th order lowpass filter. The amplitude response of the filter approximates a raised cosine filter with an alpha of one. The gain at the cutoff frequency is -3dB and the attenuation at twice the cutoff frequency is 43dB. The

cutoff frequency of the LTC1069-7 is set by an external clock and is equal to the clock frequency divided by 25. The ratio of the internal sampling frequency to the cutoff frequency is 50:1 that is, the input signal is sampled twice per clock cycle to lower the risk of aliasing. The LTC1069-7 can be operated from a single 5V supply up to dual $\pm 5\text{V}$ supplies.

The gain and phase response of the LTC1069-7 can be used in digital communication systems where pulse shaping and channel bandwidth limiting must be carried out. Any system that requires an analog filter with linear phase and sharper roll off than conventional Bessel filters can use the LTC1069-7.

The LTC1069-7 has a wide dynamic range. With $\pm 5\text{V}$ supplies and an input range of 0.1V_{RMS} to 2V_{RMS} , the signal-to-(noise + THD) ratio is $\geq 60\text{dB}$. The wideband noise of the LTC1069-7 is $140\mu\text{V}_{\text{RMS}}$. *Unlike other LTC1069-X filters, the typical passband gain of the LTC1069-7 is equal to $-1\text{V}/\text{V}$.*

The LTC1069-7 is available in an SO-8 package.

Other filter responses with lower power/speed specifications can be obtained. Please contact LTC Marketing.

LT, LT, LTC and LTM are registered trademarks of Linear Technology Corporation.

TYPICAL APPLICATION

Single 5V Supply, Linear Phase 100kHz Lowpass Filter

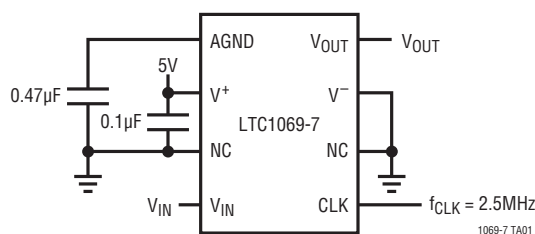

Frequency Response

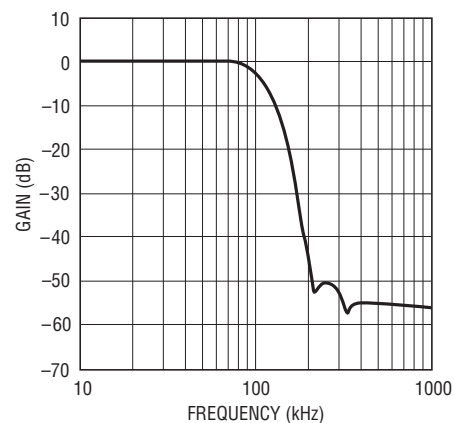

ABSOLUTE MAXIMUM RATINGS

Total Supply Voltage (V^+ to V^-)	12V
Power Dissipation	400mW
Operating Temperature Range	
LTC1069-7C	0°C to 70°C
LTC1069-7I	-40°C to 85°C
Storage Temperature.....	-65°C to 150°C
Lead Temperature (Soldering, 10 sec)	300°C

PIN CONFIGURATION

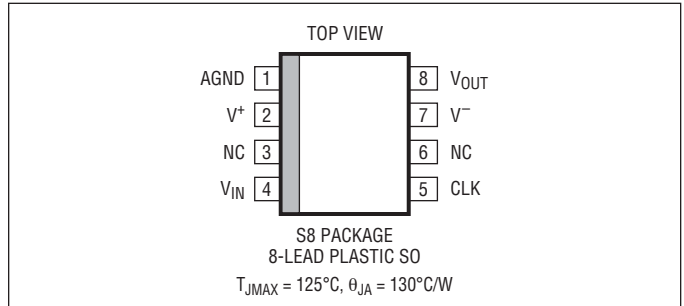

ORDER INFORMATION

LEAD FREE FINISH	TAPE AND REEL	PART MARKING	PACKAGE DESCRIPTION	TEMPERATURE RANGE
	LTC1069-7CS8#TRPBF	10697	8-Lead Plastic SO	0°C to 70°C
	LTC1069-7IS8#TRPBF	10697I	8-Lead Plastic SO	-40°C to 85°C

Consult LTC Marketing for parts specified with wider operating temperature ranges.

Consult LTC Marketing for information on non-standard lead based finish parts.

For more information on lead free part marking, go to: <http://www.linear.com/leadfree/>

For more information on tape and reel specifications, go to: <http://www.linear.com/tapeandreel/>

ELECTRICAL CHARACTERISTICS

The ● denotes specifications which apply over the full operating temperature range. f_{CUTOFF} is the filter's cutoff frequency and is equal to $f_{CLK}/25$. The f_{CLK} signal level is TTL or CMOS (max clock rise or fall time $\leq 1\mu s$), $R_L = 10k$, $T_A = 25^\circ C$, unless otherwise specified. All AC gains are measured relative to the passband gain.

SYMBOL	CONDITIONS	MIN	TYP	MAX	UNITS
Passband Gain ($f_{IN} \leq 0.2f_{CUTOFF}$)	$V_S = \pm 5V$, $f_{CLK} = 2.5MHz$ $f_{TEST} = 1kHz$, $V_{IN} = 1V_{RMS}$	●	-0.10	± 0.75 ± 0.90	dB dB
	$V_S = 4.75V$, $f_{CLK} = 500kHz$ $f_{TEST} = 1kHz$, $V_{IN} = 0.5V_{RMS}$	●	-0.10	± 0.75 ± 0.90	dB dB
Gain at $0.25f_{CUTOFF}$	$V_S = \pm 5V$, $f_{CLK} = 2.5MHz$ $f_{TEST} = 25kHz$, $V_{IN} = 1V_{RMS}$	●	-0.55	-0.30 -0.1	dB dB
	$V_S = 4.75V$, $f_{CLK} = 500kHz$ $f_{TEST} = 5kHz$, $V_{IN} = 0.5V_{RMS}$	●	-0.30	-0.05 0.15	dB dB
Gain at $0.50f_{CUTOFF}$	$V_S = \pm 5V$, $f_{CLK} = 2.5MHz$ $f_{TEST} = 50kHz$, $V_{IN} = 1V_{RMS}$	●	-1.40	-1.0 -0.35	dB dB
	$V_S = 4.75V$, $f_{CLK} = 500kHz$ $f_{TEST} = 10kHz$, $V_{IN} = 0.5V_{RMS}$	●	-0.60	-0.30 0	dB dB
Gain at $0.75f_{CUTOFF}$	$V_S = \pm 5V$, $f_{CLK} = 2.5MHz$ $f_{TEST} = 75kHz$, $V_{IN} = 1V_{RMS}$	●	-2.1	-1.65 -0.80	dB dB
	$V_S = 4.75V$, $f_{CLK} = 500kHz$ $f_{TEST} = 15kHz$, $V_{IN} = 0.5V_{RMS}$	●	-1.15	-0.75 -0.25	dB dB
Gain at f_{CUTOFF}	$V_S = \pm 5V$, $f_{CLK} = 2.5MHz$ $f_{TEST} = 100kHz$, $V_{IN} = 1V_{RMS}$	●	-4.0	-3.5 -2.7	dB dB
	$V_S = 4.75V$, $f_{CLK} = 500kHz$ $f_{TEST} = 20kHz$, $V_{IN} = 0.5V_{RMS}$	●	-3.3	-2.9 -2.4	dB dB

ELECTRICAL CHARACTERISTICS The ● denotes specifications which apply over the full operating temperature range. f_{CUTOFF} is the filter's cutoff frequency and is equal to $f_{\text{CLK}}/25$. The f_{CLK} signal level is TTL or CMOS (max clock rise or fall time $\leq 1\mu\text{s}$), $R_L = 10\text{k}$, $T_A = 25^\circ\text{C}$, unless otherwise specified. All AC gains are measured relative to the passband gain.

SYMBOL	CONDITIONS	MIN	TYP	MAX	UNITS
Gain at $1.5f_{\text{CUTOFF}}$	$V_S = \pm 5\text{V}$, $f_{\text{CLK}} = 2.5\text{MHz}$ $f_{\text{TEST}} = 150\text{kHz}$, $V_{\text{IN}} = 1V_{\text{RMS}}$	-19	-16.5	-14	dB dB
	$V_S = 4.75\text{V}$, $f_{\text{CLK}} = 500\text{kHz}$ $f_{\text{TEST}} = 30\text{kHz}$, $V_{\text{IN}} = 0.5V_{\text{RMS}}$	-20	-18.1	-17	dB dB
Gain at $2.0f_{\text{CUTOFF}}$	$V_S = \pm 5\text{V}$, $f_{\text{CLK}} = 2.5\text{MHz}$ $f_{\text{TEST}} = 200\text{kHz}$, $V_{\text{IN}} = 1V_{\text{RMS}}$	-55	-43	-38	dB dB
	$V_S = 4.75\text{V}$, $f_{\text{CLK}} = 500\text{kHz}$ $f_{\text{TEST}} = 40\text{kHz}$, $V_{\text{IN}} = 0.5V_{\text{RMS}}$	-48	-41	-39	dB dB
Gain at $5.0f_{\text{CUTOFF}}$	$V_S = 4.75\text{V}$, $f_{\text{CLK}} = 500\text{kHz}$ $f_{\text{TEST}} = 100\text{kHz}$, $V_{\text{IN}} = 0.5V_{\text{RMS}}$	-70	-59	-55	dB
Gain at f_{CUTOFF} (160kHz)	$V_S = \pm 5\text{V}$, $f_{\text{CLK}} = 4\text{MHz}$ $f_{\text{TEST}} = 160\text{kHz}$, $V_{\text{IN}} = 1V_{\text{RMS}}$		-2.1		dB
Phase at $0.5f_{\text{CUTOFF}}$	$V_S = \pm 5\text{V}$, $f_{\text{CLK}} = 2.5\text{MHz}$ $f_{\text{TEST}} = 50\text{kHz}$	-35	-30.5	-25	Deg
Phase at f_{CUTOFF}	$V_S = \pm 5\text{V}$, $f_{\text{CLK}} = 2.5\text{MHz}$ $f_{\text{TEST}} = 100\text{kHz}$	-240	-235	-230	Deg
Passband Phase Deviation from Linear Phase (Note 1)	$V_S = \pm 5\text{V}$, $f_{\text{CLK}} = 500\text{kHz}$		-3.0		Deg
Output DC Offset (Input at GND)	$V_S = \pm 5\text{V}$, $f_{\text{CLK}} = 500\text{kHz}$		50		mV
	$V_S = 4.75\text{V}$, $f_{\text{CLK}} = 400\text{kHz}$		25	125	mV
Output Voltage Swing	$V_S = \pm 5\text{V}$, $I_{\text{SOURCE}}/I_{\text{SINK}} \leq 1\text{mA}$, $R_L = 10\text{k}$	● ± 3.5	± 4.0		V
	$V_S = 4.75\text{V}$, $I_{\text{SOURCE}}/I_{\text{SINK}} \leq 1\text{mA}$, $R_L = 10\text{k}$	● 2.6	3.6		$V_{\text{P-P}}$
Power Supply Current	$V_S = \pm 5\text{V}$, $f_{\text{CLK}} = 500\text{kHz}$	●	18	26	mA
	$V_S = 4.75\text{V}$, $f_{\text{CLK}} = 400\text{kHz}$	●	13	15	mA
				16.5	mA

Note 1: Stresses beyond those listed under Absolute Maximum Ratings may cause permanent damage to the device. Exposure to any Absolute Maximum Rating condition for extended periods may affect device reliability and lifetime.

Note 2: Phase Deviation = $1/2(\text{Phase at } 0\text{Hz} - \text{Phase at } f_{\text{CUTOFF}}) - (\text{Phase at } 0\text{Hz} - \text{Phase at } 0.5f_{\text{CUTOFF}})$

Phase at 0Hz = 180° (guaranteed by design)

Example: An LTC1069-7 has Phase at $0.5f_{\text{CUTOFF}} = -30.5^\circ$ and Phase at $f_{\text{CUTOFF}} = -235^\circ$.

Passband Phase Deviation from Linear Phase

$$= 1/2[180^\circ - (-235^\circ)] - [(180^\circ - (-30.5^\circ))] = -3^\circ$$

TYPICAL PERFORMANCE CHARACTERISTICS

Passband Gain vs Frequency

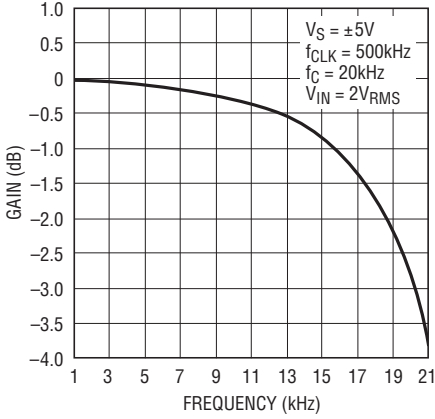

1069-7 G01

Transition Band Gain vs Frequency

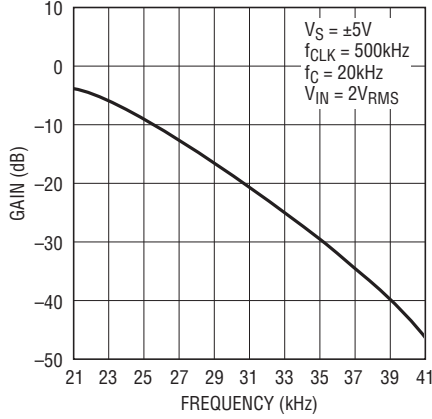

1069-7 G02

Stopband Gain vs Frequency

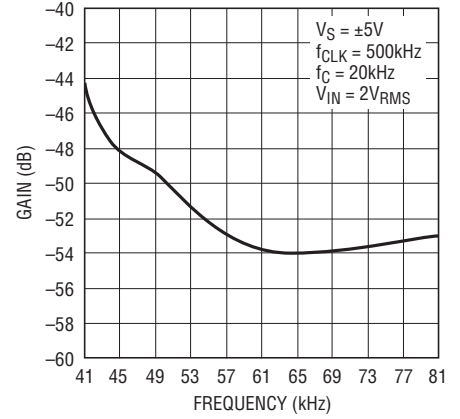

1069-7 G03

Gain vs Frequency

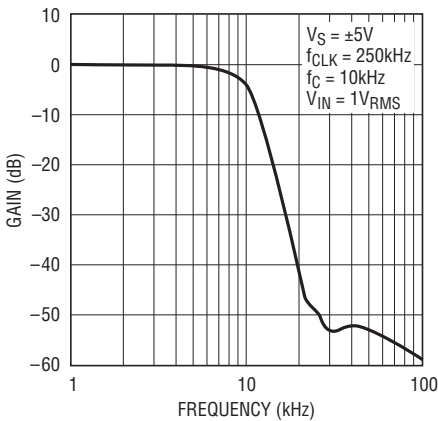

1069-7 G04

Passband Gain vs Clock Frequency

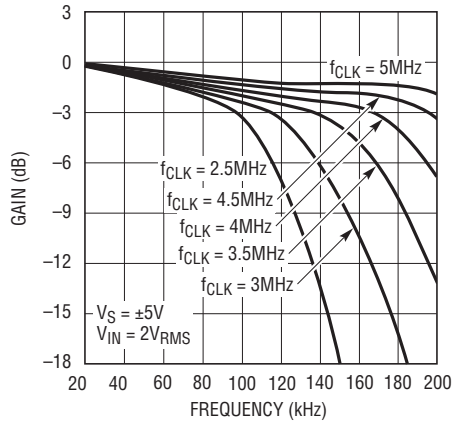

1069-7 G05

Passband Gain vs Frequency

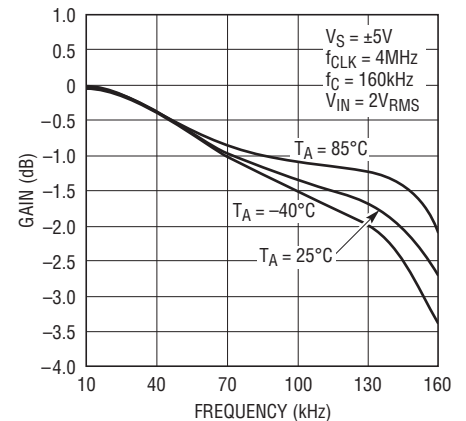

1069-7 G06

Gain vs Supply Voltage

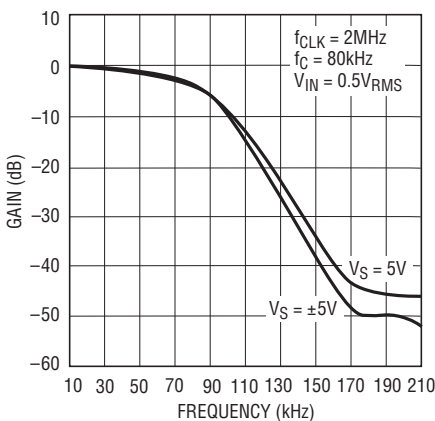

1069-7 G07

Passband Gain vs Clock Frequency

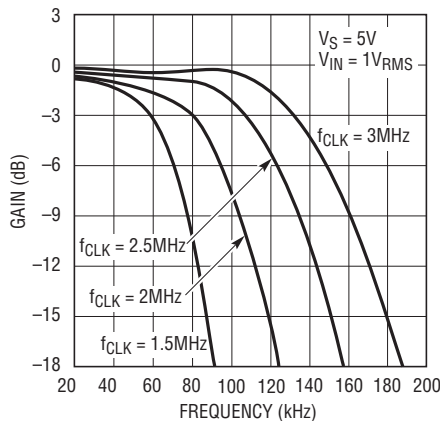

1069-7 G08

Passband Gain vs Frequency

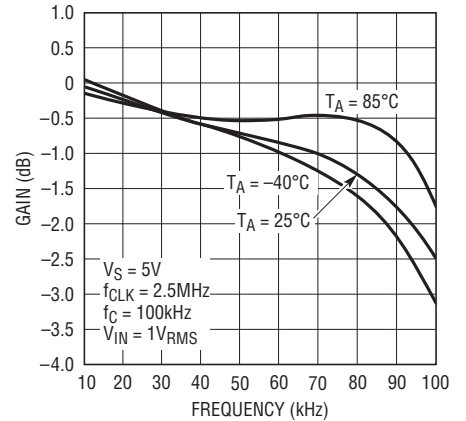

1069-7 G09

TYPICAL PERFORMANCE CHARACTERISTICS

Passband Gain and Phase vs Frequency

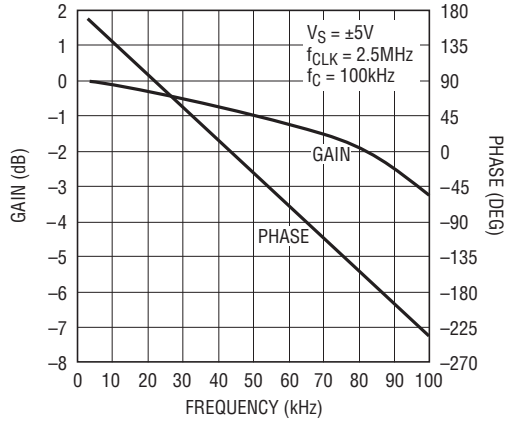

1069-7 G10

Passband Gain and Delay vs Frequency

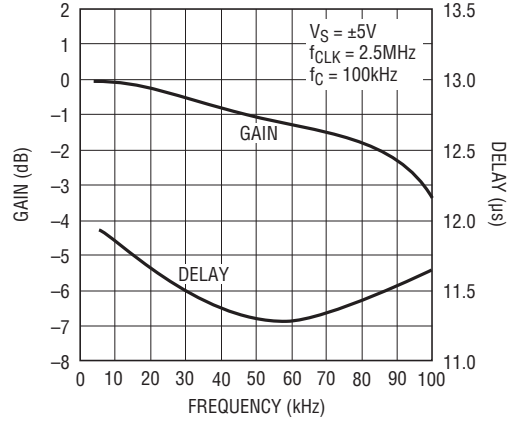

1069-7 G12

Phase Matching vs Frequency

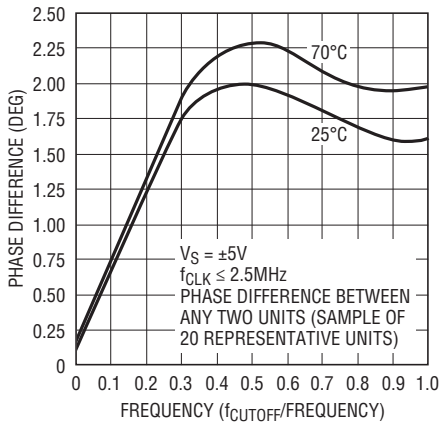

1069-7 G11

THD + Noise vs Input (Vp-p)

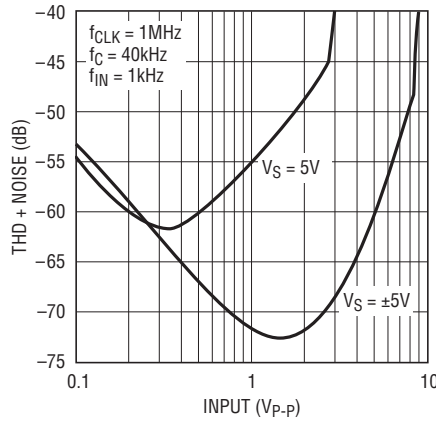

1069-7 G13

THD + Noise vs Frequency

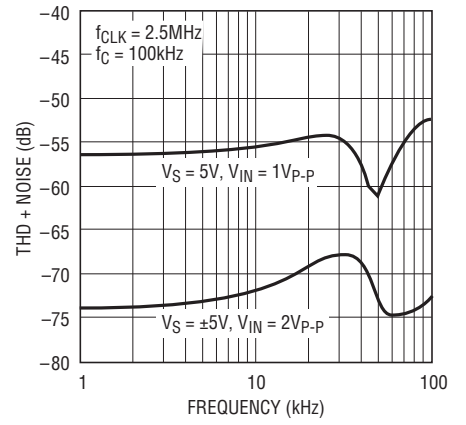

1069-7 G14

Transient Response

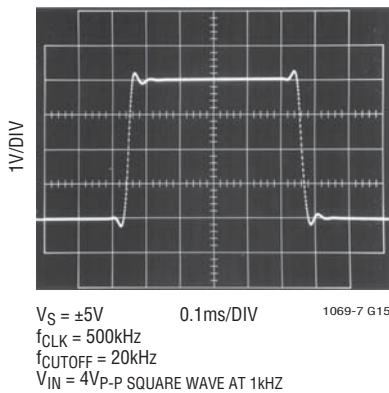

1069-7 G15

Output Offset vs Clock Frequency

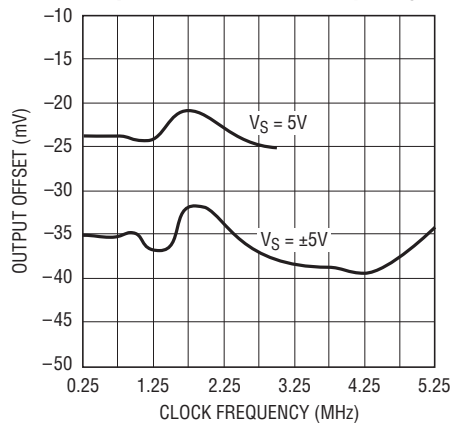

1069-7 G16

Output Voltage Swing vs Temperature

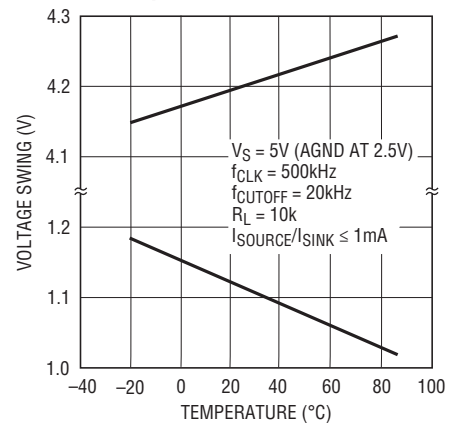

1069-7 G17

TYPICAL PERFORMANCE CHARACTERISTICS

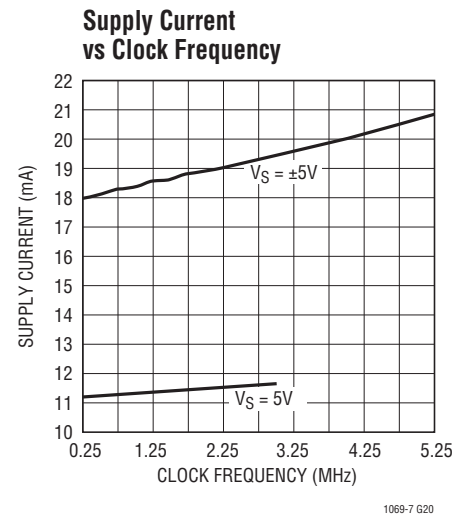
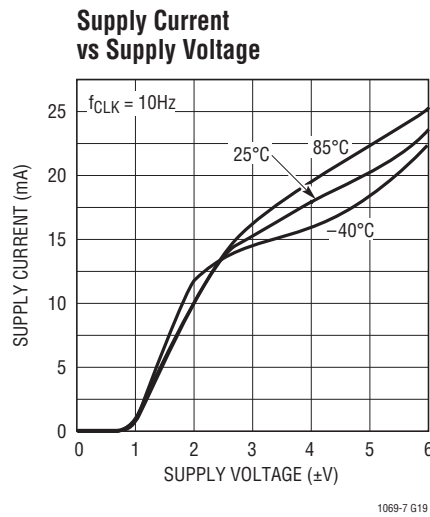
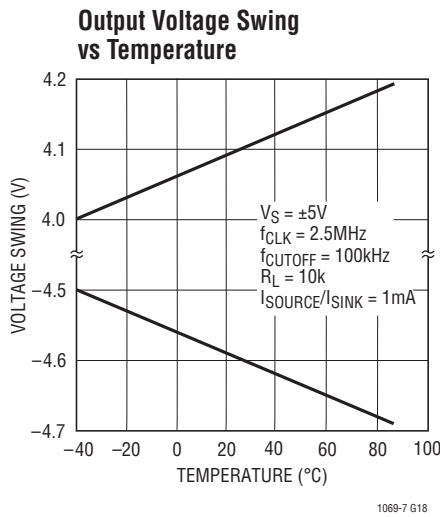

PIN FUNCTIONS

AGND (Pin 1): Analog Ground. The quality of the analog signal ground can affect the filter performance. For either single or dual supply operation, an analog ground plane surrounding the package is recommended. The analog ground plane should be connected to any digital ground at a single point. For dual supply operation, Pin 1 should be connected to the analog ground plane.

For single supply operation, Pin 1 should be bypassed to the analog ground plane with a capacitor $0.47\mu F$ or larger. An internal resistive divider biases Pin 1 to half the total power supply. Pin 1 should be buffered if used to bias other ICs. Figure 1 shows the connections for single supply operation.

V⁺, V⁻ (Pins 2, 7): Power Supplies. The V⁺ (Pin 2) and V⁻ (Pin 7) should be bypassed with a $0.1\mu F$ capacitor to an adequate analog ground. The filter's power supplies should be isolated from other digital or high voltage analog supplies. A low noise linear supply is recommended. Using switching power supplies will lower the signal-to-noise ratio of the filter. Unlike previous monolithic filters, the power supplies can be applied in any order, that is, the positive supply can be applied before the negative supply and vice versa. Figure 2 shows the connections for dual supply operation.

NC (Pins 3, 6): No Connection. Pins 3 and 6 are not connected to any internal circuitry; they should be tied to ground.

V_{IN} (Pin 4): Filter Input. The filter input pin is internally connected to the inverting inputs of two op amps through a $36k$ resistor for each op amp. This parallel combination creates an $18k$ input impedance.

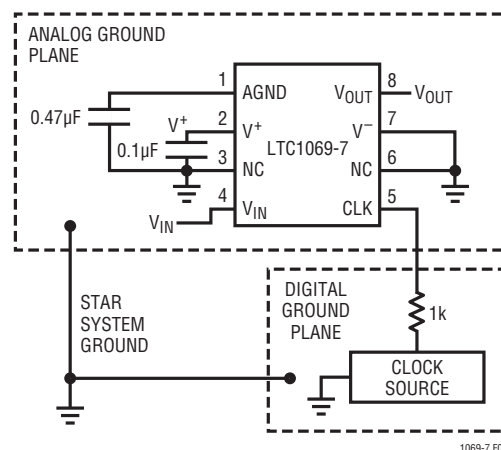

Figure 1. Connections for Single Supply Operation

PIN FUNCTIONS

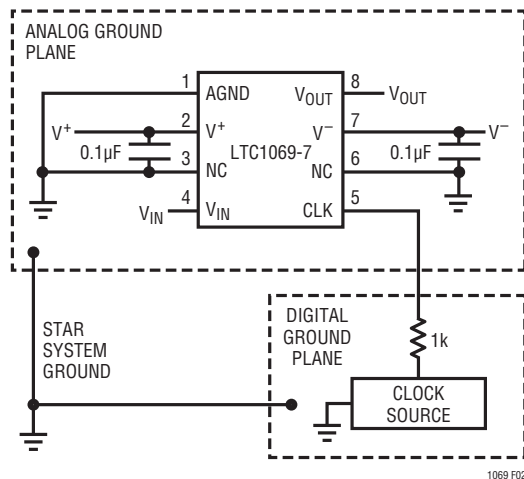

Figure 2. Connections for Dual Supply Operation

CLK (Pin 5): Clock Input. Any TTL or CMOS clock source with a square wave output and 50% duty cycle ($\pm 10\%$) is an adequate clock source for the device. The power supply for the clock source should not necessarily be the filter's power supply. The analog ground of the filter should only be connected to the clock's ground at a single point. Table 1 shows the clock's low and high level threshold value for

a dual or single supply operation. A pulse generator can be used as a clock source provided the high level on-time is greater than $0.42\mu\text{s}$ ($V_S = \pm 5\text{V}$). Sine waves less than 100kHz are not recommended for clock sources because excessive slow clock rise or fall times generate internal clock jitter. The maximum clock rise or fall time is $1\mu\text{s}$. The clock signal should be routed from the right side of the IC package to avoid coupling into any input or output analog signal path. A 1k resistor between the clock source and the clock input (Pin 5) will slow down the rise and fall times of the clock to further reduce charge coupling, Figure 1.

Table 1. Clock Source High and Low Thresholds

POWER SUPPLY	HIGH LEVEL	LOW LEVEL
Dual Supply = $\pm 5\text{V}$	1.5V	0.5V
Single Supply = 10V	6.5V	5.5V
Single Supply = 5V	1.5V	0.5V

V_{OUT} (Pin 8): Filter Output. Pin 8 is the output of the filter, and it can source 23mA or sink 16mA. The total harmonic distortion of the filter will degrade when driving coaxial cables or loads less than 20k without an output buffer.

APPLICATIONS INFORMATION

Temperature Behavior

The power supply current of the LTC1069-7 has a positive temperature coefficient. The GBW product of its internal op amps is nearly constant and the speed of the device does not degrade at high temperatures.

Clock Feedthrough

The clock feedthrough is defined as the RMS value of the clock frequency and its harmonics that are present at the filter's output (Pin 8). The clock feedthrough is tested with the input (Pin 4) shorted to the AGND pin and depends on PC board layout and on the value of the power supplies. With proper layout techniques the values of the clock feedthrough are shown on Table 2.

Table 2. Clock Feedthrough

V _S	CLOCK FEEDTHROUGH
5V	400 μV_{RMS}
$\pm 5\text{V}$	850 μV_{RMS}

Any parasitic switching transients during the rising and falling edges of the incoming clock are not part of the clock feedthrough specifications. Switching transients have frequency contents much higher than the applied clock; their amplitude strongly depends on scope probing techniques as well as grounding and power supply bypassing. The clock feedthrough can be reduced by adding a single RC lowpass filter at the output (Pin 8) of the LTC1069-7.

APPLICATIONS INFORMATION

Wideband Noise

The wideband noise of the filter is the total RMS value of the device's noise spectral density and determines the operating signal-to-noise ratio. Most of the wideband noise frequency contents lie within the filter passband. The wideband noise cannot be reduced by adding post filtering. The total wideband noise is nearly independent of the clock frequency and depends slightly on the power supply voltage (see Table 3). The clock feedthrough specifications are not part of the wideband noise.

Table 3. Wideband Noise

V_S	CLOCK FEEDTHROUGH
4.75V	125 μ V _{RMS}
± 5 V	140 μ V _{RMS}

Aliasing

Aliasing is an inherent phenomenon of sampled data systems and it occurs for input frequencies approaching the sampling frequency. The internal sampling frequency of the LTC1069-7 is 50 times its f_{CUTOFF} frequency. For instance if a 48kHz, 100mV_{RMS} signal is applied at the

input of an LTC1069-7 operating with a 50% duty cycle 25kHz clock, a 2kHz, 741 μ V_{RMS} alias signal will appear at the filter output. Table 4 shows details.

Table 4. Aliasing

INPUT FREQUENCY $V_{IN} = 1V_{RMS}$	OUTPUT LEVEL Relative to Input	OUTPUT FREQUENCY Aliased Frequency
$f_{CLK}/f_C = 25:1$, $f_{CUTOFF} = 1kHz$		
40kHz (or 60kHz)	-59.9dB	10kHz
47kHz (or 53kHz)	-54.2dB	3kHz
48kHz (or 52kHz)	-42.6dB	2kHz
48.5kHz (or 51.5kHz)	-18.3dB	1.5kHz
49kHz (or 52kHz)	-2.9dB	1.0kHz
49.5kHz (or 50.5kHz)	-0.65dB	0.5kHz

Speed Limitations

To avoid op amp slew rate limiting, the signal amplitude should be kept below a specified level as shown in Table 5.

Table 5. Maximum V_{IN} vs V_S and Clock

V_S	MAXIMUM CLOCK	MAXIMUM V_{IN}
5V	$\geq 2.5MHz$	340mV _{RMS} ($f_{IN} \geq 200kHz$)
± 5 V	$\geq 4.5MHz$	1.2V _{RMS} ($f_{IN} \geq 400kHz$)

PACKAGE DESCRIPTION

S8 Package 8-Lead Plastic Small Outline (Narrow 0.150) (LTC DWG # 05-08-1610)

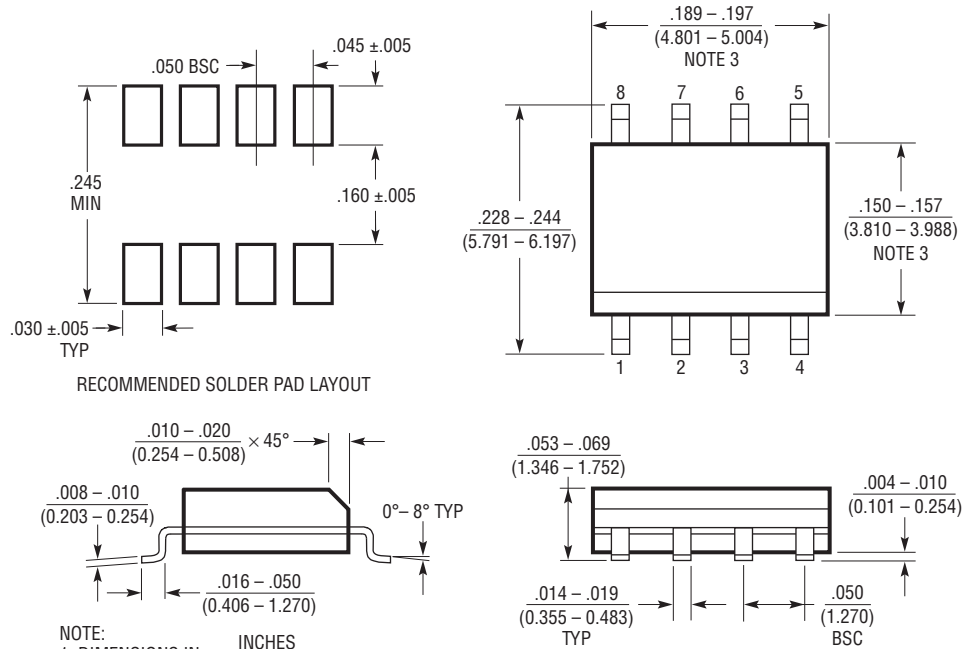

RECOMMENDED SOLDER PAD LAYOUT

- NOTE:
 1. DIMENSIONS IN $\frac{\text{INCHES}}{\text{(MILLIMETERS)}}$
 2. DRAWING NOT TO SCALE
 3. THESE DIMENSIONS DO NOT INCLUDE MOLD FLASH OR PROTRUSIONS.
 MOLD FLASH OR PROTRUSIONS SHALL NOT EXCEED $.006"$ (0.15mm)

S08 0303

TYPICAL APPLICATION

Clock Tunable, Noninverting, Linear Phase 8th Order Filter to 200kHz f_{CUTOFF}

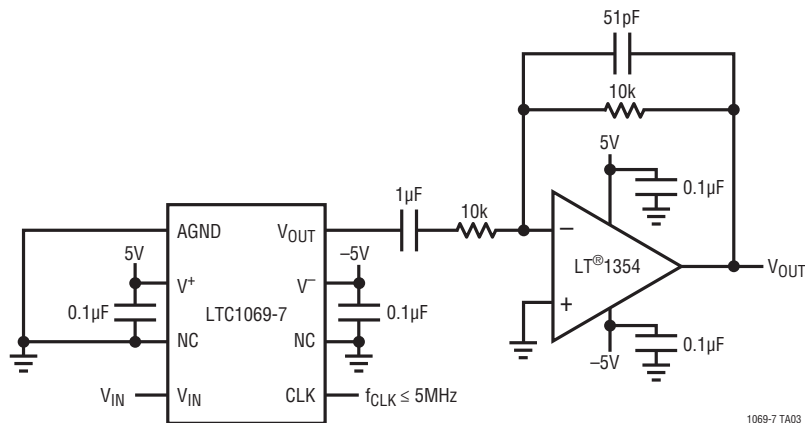

1069-7 TA03

RELATED PARTS

PART NUMBER	DESCRIPTION	COMMENTS
LTC1064-3	Linear Phase, Bessel 8th Order Filter	$f_{CLK}/f_C = 75/1$ or $150/1$, Very Low Noise
LTC1064-7	Linear Phase, 8th Order Lowpass Filter	$f_{CLK}/f_C = 50/1$ or $100/1$, $f_{C(MAX)} = 100kHz$
LTC1164-7	Low Power, Linear Phase Lowpass Filter	$f_{CLK}/f_C = 50/1$ or $100/1$, $I_S = 2.5mA$, $V_S = 5V$
LTC1264-7	Linear Phase 8th Order Lowpass Filter	$f_{CLK}/f_C = 25/1$ or $50/1$, $f_{C(MAX)} = 200kHz$