

OBSOLETE:
FOR INFORMATION PURPOSES ONLY
 Contact Linear Technology for Potential Replacement

FEATURES

- **Single Chip 5V LocalTalk Port**
- **Low Power: $I_{CC} = 1\text{mA Typ}$**
- Shutdown Pin Reduces I_{CC} to $1\mu\text{A Typ}$
- **Digitally Selectable Low Slew Rate Mode for Reduced EMI Emissions**
- Drivers Maintain High Impedance in Three-State or with Power Off
- Thermal Shutdown Protection
- Drivers Are Short-Circuit Protected

APPLICATIONS

- LocalTalk Peripherals
- Notebook and Palmtop Computers
- Battery-Powered Systems

DESCRIPTION

The LTC[®]1324 is a single 5V line transceiver designed to operate on Apple[®]LocalTalk networks. The driver features a digitally selectable low slew rate mode for reduced EMI emissions. The chip draws only 1mA quiescent current when active and 1 μ A in shutdown. The differential driver outputs three-state when disabled, during shutdown or when the power is off. The driver outputs will maintain high impedance even with output common mode voltages beyond the power supply rails. Both the driver outputs and receiver inputs are protected against ESD damage to $\pm 10\text{kV}$.

The LTC1324 is available in a 16-pin SO Wide package.

LT, LTC, and LT are registered trademarks of Linear Technology Corporation.
 Apple and LocalTalk are registered trademarks of Apple Computer, Inc.

TYPICAL APPLICATION

Typical LocalTalk Connection for Low EMI

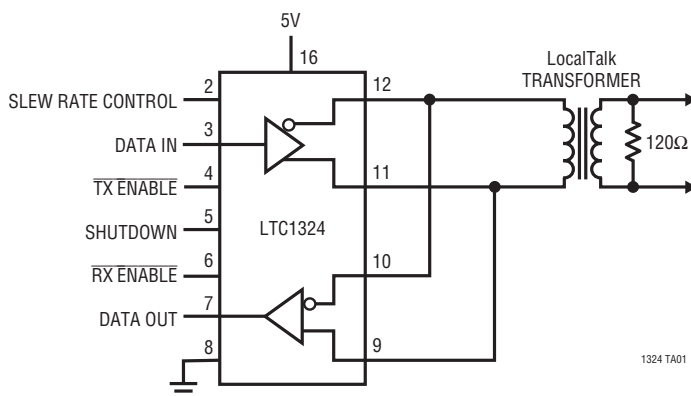

Waveform of Driver

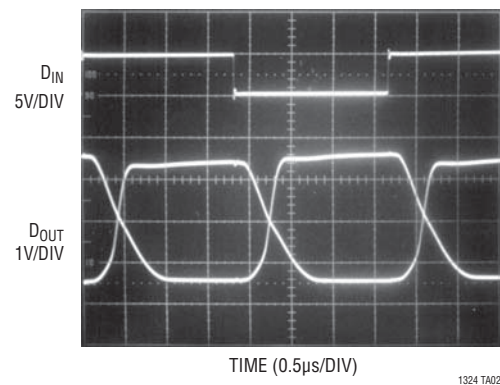

LTC1324

ABSOLUTE MAXIMUM RATINGS

(Note 1)

Supply Voltage (V_{CC})	7V
Input Voltage (Logic Inputs)	-0.3V to ($V_{CC} + 0.3V$)
Input Voltage (Receiver Inputs)	$\pm 1.5V$
Driver Output Voltage (Forced)	$\pm 1.5V$
Driver Short-Circuit Duration	Indefinite
Operating Temperature Range	0°C to 70°C
Storage Temperature Range	-65°C to 150°C
Lead Temperature (Soldering, 10 sec)	300°C

PACKAGE/ORDER INFORMATION

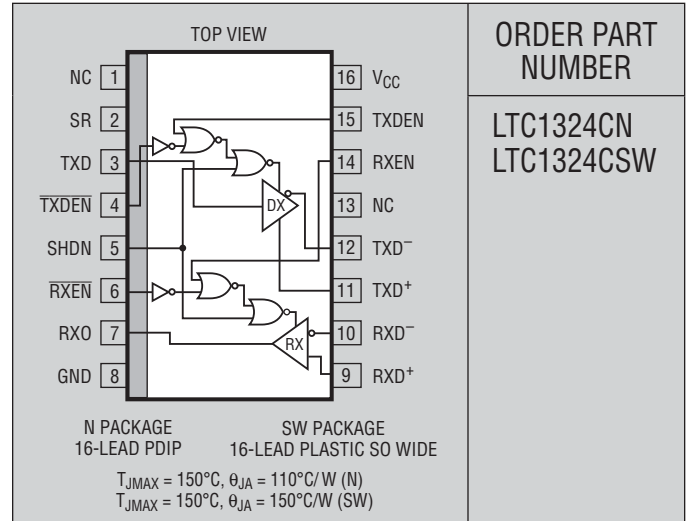

ORDER PART NUMBER

LTC1324CN
LTC1324CSW

Consult factory for Industrial and Military grade parts.

ELECTRICAL CHARACTERISTICS

$V_{CC} = 5V, T_A = 0^{\circ}C$ to $70^{\circ}C$ (Notes 2, 3), unless otherwise noted.

SYMBOL	PARAMETER	CONDITIONS	MIN	TYP	MAX	UNITS	
Supplies							
I_{CC}	Normal Operation Supply Current	No Load, SHDN = 0V, $\overline{TXDEN} = 0V, \overline{RXEN} = 0V$	●	1	2	mA	
	Shutdown Supply Current	No Load, SHDN = V_{CC}	●	1	10	μA	
Differential Driver							
V_{OD}	Differential Output Voltage	No Load	●	± 4.0		V	
		$R_L = 50\Omega$ (Figure 1)	●	± 2.0		V	
ΔV_{OD}	Change in Magnitude of Differential Output Voltage	$R_L = 50\Omega$ (Figure 1)		0.2		V	
V_{OC}	Differential Common Mode Output Voltage	$R_L = 50\Omega$ (Figure 1)		3.0		V	
I_{SS}	Short-Circuit Current	$0V \leq V_O \leq 5V$	●	35	120	250	mA
I_{OZ}	Three-State Output Current	($\overline{TXDEN} = V_{CC}$ and TXDEN = GND) or SHDN = V_{CC} or Power Off, $-10V \leq V_O \leq 10V$	●	± 2	± 200	μA	
Logic Inputs							
V_{IH}	Input High Voltage	All Logic Input Pins	●	2.4		V	
V_{IL}	Input Low Voltage	All Logic Input Pins	●		0.8	V	
I_{IN}	Input Current	SHDN, $\overline{TXDEN}, \overline{RXDEN}, V = 0V$ to V_{CC}	●	± 1	± 20	μA	
I_{DN}	Pull-Down Current	RXDEN, TXDEN, SR, $V = 0V$ to V_{CC}	●	15	60	μA	
Receiver							
R_{IN}	Input Resistance	$-7V \leq V_{IN} \leq 7V$		12		k Ω	
	Receiver Threshold Voltage	$-7V \leq V_{CM} \leq 7V$	●	-200	200	mV	
	Receiver Input Hysteresis	$-7V \leq V_{CM} \leq 7V$		70		mV	
V_{OH}	Output High Voltage	$I_O = -4mA$	●	3.5		V	
V_{OL}	Output Low Voltage	$I_O = 4mA$	●		0.4	V	
I_{SS}	Output Short-Circuit Current	$0V \leq V_O \leq 5V$	●	7	85	mA	
I_{OZ}	Output Three-State Current	$0V \leq V_O \leq 5V, \overline{RXEN} = V_{CC}, \overline{RXEN} = GND$	●	± 2	± 100	μA	

1324fa

ELECTRICAL CHARACTERISTICS $V_{CC} = 5V, T_A = 0^{\circ}C$ to $70^{\circ}C$ (Notes 2, 3), unless otherwise noted.

SYMBOL	PARAMETER	CONDITIONS	MIN	TYP	MAX	UNITS
Switching Characteristics						
t_{PLH}, t_{PHL}	Driver Propagation Delay Without Slew Rate Control	$R_L = 100\Omega, C_L = 100pF$ (Figures 2, 4) SR = GND	●	40	120	ns
	Driver Propagation Delay with Slew Rate Control	$R_L = 100\Omega, C_L = 100pF$ (Figures 2, 4) SR = V_{CC}	●	0.4	1.2	μs
	Receiver Propagation Delay	$C_L = 15pF$ (Figures 2, 6)	●	40	120	ns
t_{SKEW}	Driver Output to Output Without Slew Rate Control	$R_L = 100\Omega, C_L = 100pF$ (Figures 2, 4) SR = GND	●	10	35	ns
	Driver Output to Output with Slew Rate Control	$R_L = 100\Omega, C_L = 100pF$ (Figures 2, 4) SR = V_{CC}	●	25	100	ns
t_r, t_f	Driver Rise/Fall Time Without Slew Rate Control	$R_L = 100\Omega, C_L = 100pF$ (Figures 2,4) SR = GND	●	20	50	ns
	Driver Rise/Fall Time with Slew Rate Control	$R_L = 100\Omega, C_L = 100pF$ (Figures 2, 4) SR = V_{CC}	●	0.4	1.2	μs
t_{Hdis}, t_{Ldis}	Driver Output Active to Disable Without Slew Rate Control	$C_L = 15pF$ (Figures 3, 5) SR = GND	●	50	150	ns
	Driver Output Active to Disable with Slew Rate Control	$C_L = 15pF$ (Figures 3, 5) SR = V_{CC}	●	0.7	2	μs
	Receiver Output Active to Disable	$C_L = 15pF$ (Figures 3, 7)	●	30	100	ns
t_{ENH}, t_{ENL}	Driver Enable to Output Active Without Slew Rate Control	$C_L = 15pF$ (Figures 3, 5) SR = GND	●	50	150	ns
	Driver Enable to Output Active with Slew Rate Control	$C_L = 15pF$ (Figures 3, 5) SR = V_{CC}	●	250	750	ns
	Receiver Enable to Output Active	$C_L = 15pF$ (Figures 3, 7)	●	30	100	ns

The ● denotes specifications which apply over the full operating temperature range.

Note 1: Absolute Maximum Ratings are those values beyond which the life of a device may be impaired.

Note 2: All currents into device pins are positive and all currents out of device pins are negative. All voltages are reference to ground unless otherwise specified.

Note 3: All typicals are given at $V_{CC} = 5V, T_A = 25^{\circ}C$.

TYPICAL PERFORMANCE CHARACTERISTICS

Driver Differential Output Voltage vs Output Current

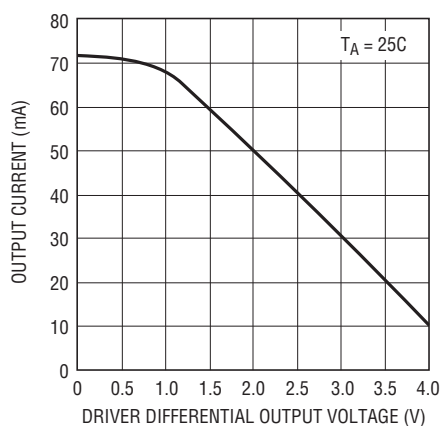

1324 G01

Driver Output Low Voltage vs Output Current

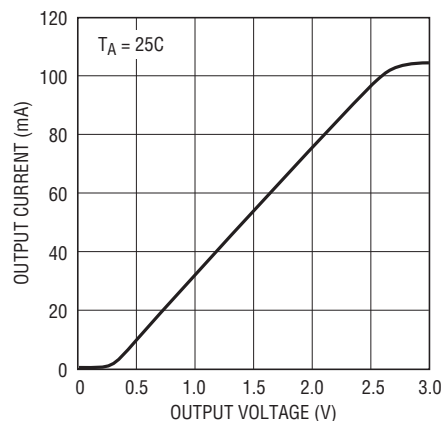

1324 G02

Driver Output High Voltage vs Output Current

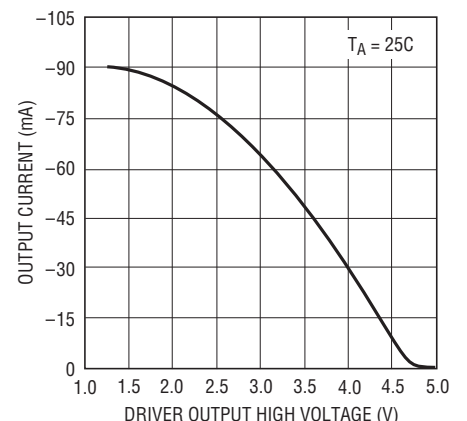

1324 G03

1324fa

TYPICAL PERFORMANCE CHARACTERISTICS

Receiver Output Low Voltage vs Output Current

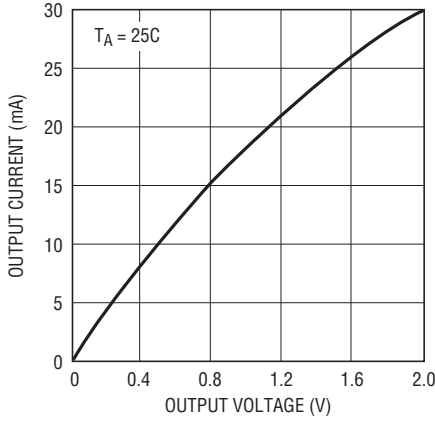

1324 G04

Receiver Output High Voltage vs Output Current

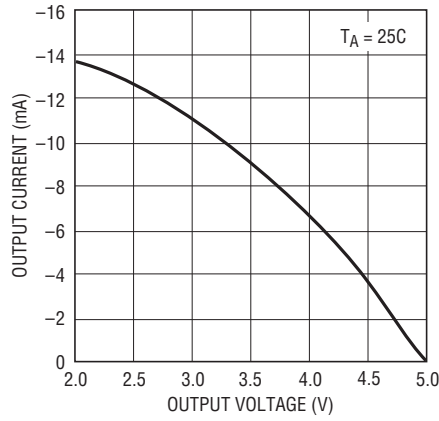

1324 G05

Driver Short-Circuit Current vs Temperature

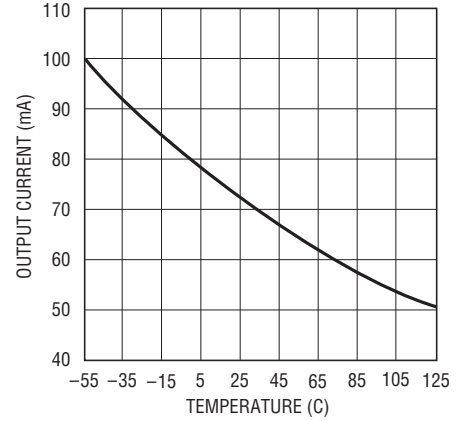

1324 G06

Receiver Short-Circuit Current vs Temperature

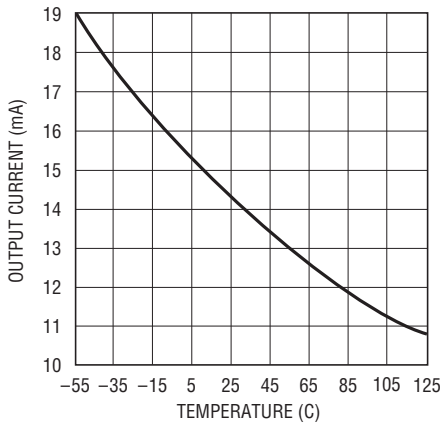

1324 G07

Supply Current (Driver and Receiver Enabled) vs Temperature

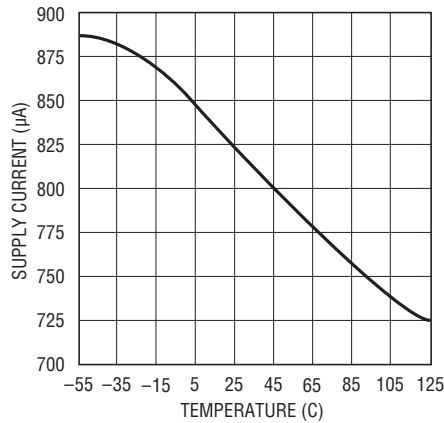

1324 G08

Driver Skew vs Temperature

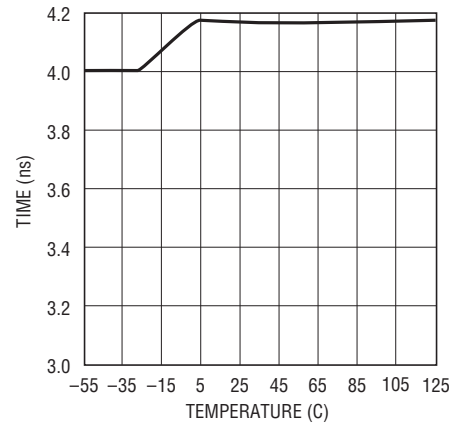

1324 G09

Receiver Output Low Voltage vs Temperature

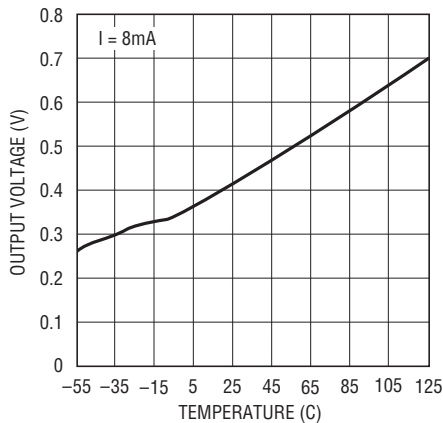

1324 G10

Receiver Output High Voltage vs Temperature

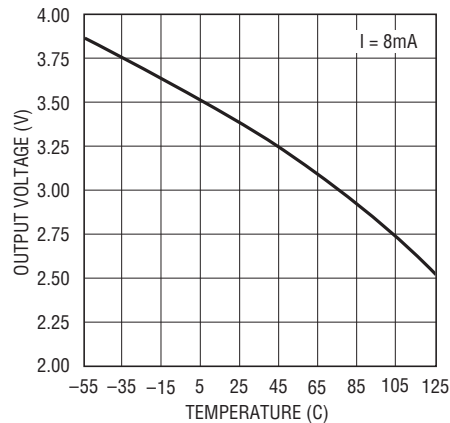

1324 G11

TYPICAL PERFORMANCE CHARACTERISTICS

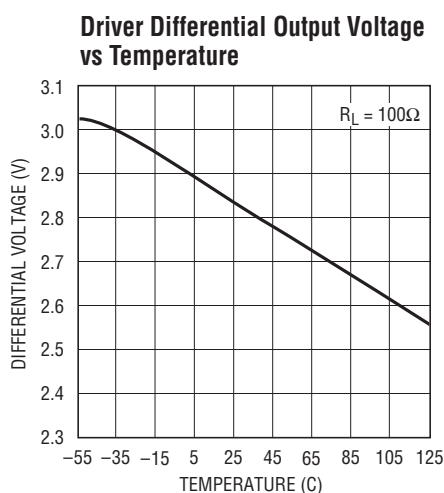

1324 G12

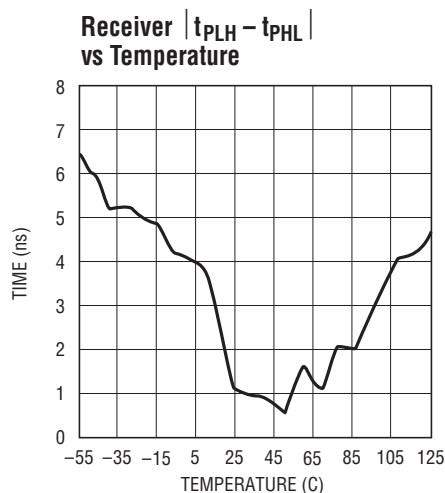

1324 G13

PIN FUNCTIONS

NC (Pins 1, 13): No Internal Connection.

SR (Pin 2): Slew Rate Control (TTL Compatible). A high level on this pin forces the RS485 driver into the low slew rate mode. A low level forces the driver into the high slew rate or normal mode. Connected to an internal pull-down.

TXD (Pin 3): RS485 Driver Input (TTL Compatible).

$\overline{\text{TXDEN}}$ (Pin 4): Driver Output Enable (TTL Compatible). A high level on this pin and a low level on TXDEN (Pin 15) forces the RS485 driver into three-state. A low level enables the driver.

SHDN (Pin 5): Shutdown Input (TTL Compatible). When this pin is high, the chip is shut down; the driver and receiver outputs three-state; and the supply current drops to 1 μ A. A low level on this pin allows normal operation.

$\overline{\text{RXEN}}$ (Pin 6): Receiver Enable (TTL Compatible). A high level on this pin and a low level on RXEN (Pin 14) disables the receiver and three-states the logic outputs. A low level allows normal operation.

RXDO (Pin 7): RS485 Receiver Output.

GND (Pin 8): Ground.

RXD⁺ (Pin 9): RS485 Receiver Noninverting Input. When this pin is $\geq 200\text{mV}$ above RXD⁻, RXDO will be high. When this pin is $\geq 200\text{mV}$ below RXD⁻, RXDO will be low.

RXD⁻ (Pin 10): RS485 Receiver Inverting Input.

TXD⁺ (Pin 11): RS485 Driver Noninverting Output.

TXD⁻ (Pin 12): RS485 Driver Inverting Output.

RXEN (Pin 14): Receiver Enable (TTL Compatible). A low level on this pin and a high level on $\overline{\text{RXEN}}$ (Pin 6) disables the receiver and three-states the logic outputs. A high level allows normal operation. Connected to an internal pull-down.

TXDEN (Pin 15): Driver Output Enable (TTL Compatible). A low level on this pin and a high level on $\overline{\text{TXDEN}}$ (Pin 4) forces the RS485 driver into three-state. A high level enables the driver. Connected to an internal pull-down.

V_{CC} (Pin 16): The Positive Supply Input. $4.75\text{V} \leq V_{CC} \leq 5.25\text{V}$. Requires a 1 μ F bypass capacitor to ground.

TEST CIRCUIT

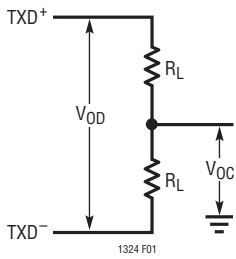

Figure 1

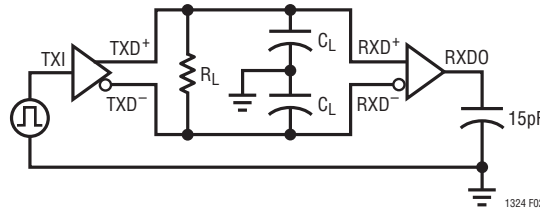

Figure 2

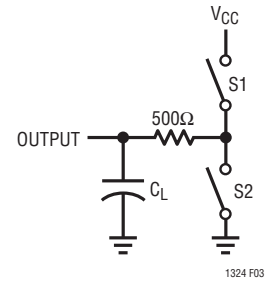

Figure 3

SWITCHING WAVEFORMS

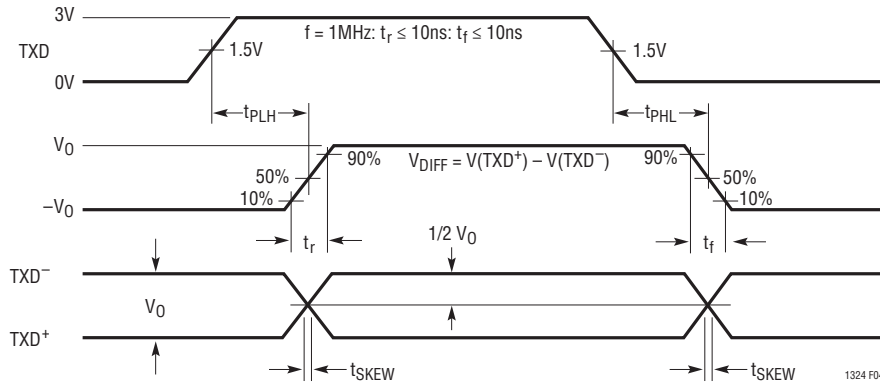

Figure 4. Differential Driver

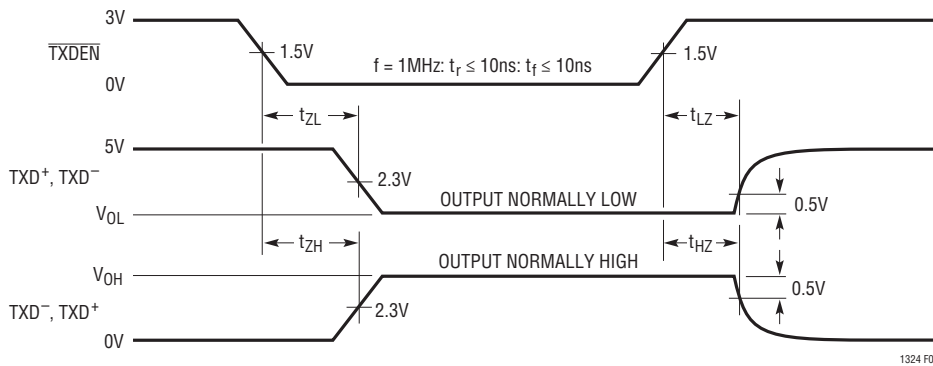

Figure 5. Differential Driver Enable and Disable

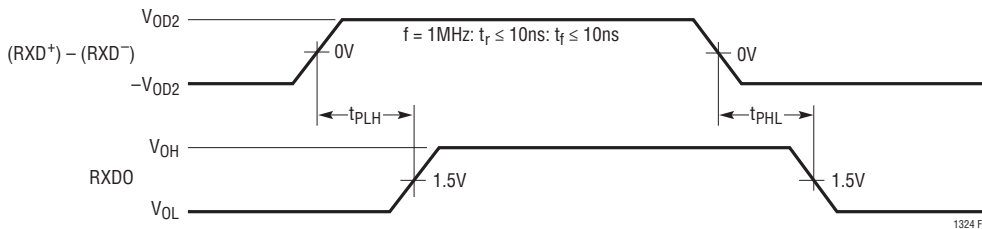

Figure 6. Differential Receiver

SWITCHING WAVEFORMS

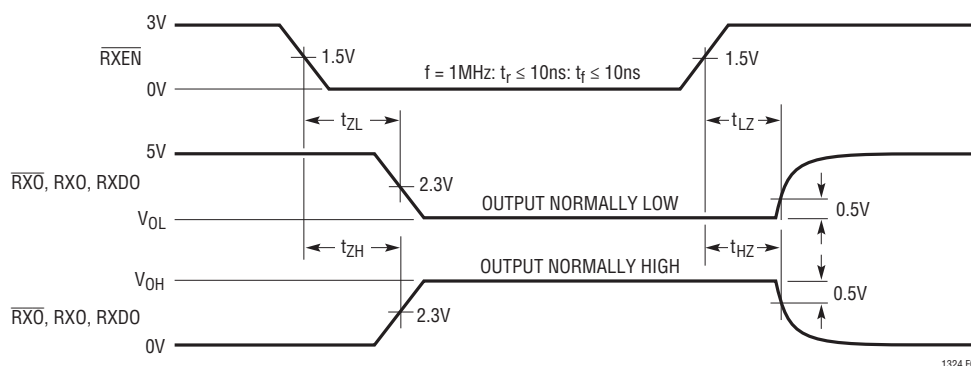

Figure 7. Receiver Enable and Disable

APPLICATIONS INFORMATION

Thermal Shutdown Protection

The LTC1324 includes a thermal shutdown circuit which protects against prolonged shorts at the driver outputs. If a driver output is shorted to another output, ground or to the power supply, the current will be initially limited to a maximum of 250mA. When the die temperature rises above 150°C, the thermal shutdown circuit turns off the driver outputs. When the die cools to about 130°C, the outputs turn on. If the short still exists, the part will heat again and the cycle will repeat. This oscillation occurs at about 10Hz and prevents the part from being damaged by excessive power dissipation. When the short is removed, the part will return to normal operation.

Power Shutdown

The power shutdown feature of the LTC1324 is designed for battery-powered systems. When SHDN is forced high, the part enters shutdown mode. In shutdown, the supply current typically drops from 1mA to 1μA and the driver and receiver outputs are three-stated.

Supply Bypassing

The LTC1324 requires V_{CC} be bypassed to prevent data errors. A 1μF capacitor from V_{CC} to ground is adequate.

EMI Filters and Slew Rate Control

Most LocalTalk applications need to use an electromagnetic interference (EMI) filter consisting of a resistor-

capacitor T network between each driver, receiver and the connector. Unfortunately, the resistors will attenuate the driver's output signal applied to the cable. Because the LTC1324 uses a single 5V supply, the resistors' values should be reduced to 5.1Ω to ensure enough voltage swing on the cable (Figure 8). Another way to get maximum swing and EMI immunity is to use a ferrite bead and capacitor as the T network (Figure 9). For data rates below 250kbps, the LTC1324 features a low EMI mode which limits the rise time of the drivers to 400ns. With a lower rise time, the EMI network can be eliminated, allowing more signal voltage to reach the cable. Figures 10 and 11 show the output signals of the driver with different slew rates.

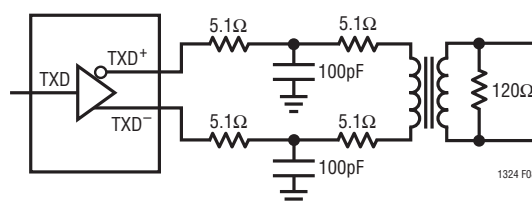

Figure 8

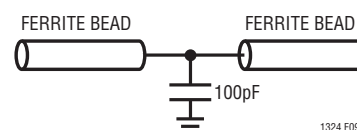

Figure 9

APPLICATIONS INFORMATION

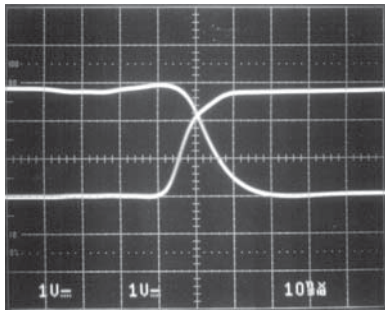

Figure 10. High Slew Rate Mode

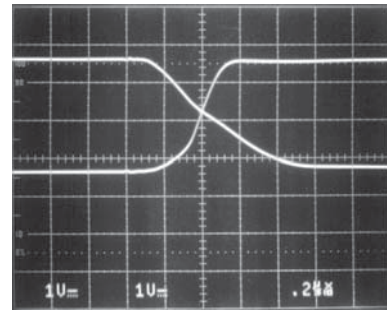
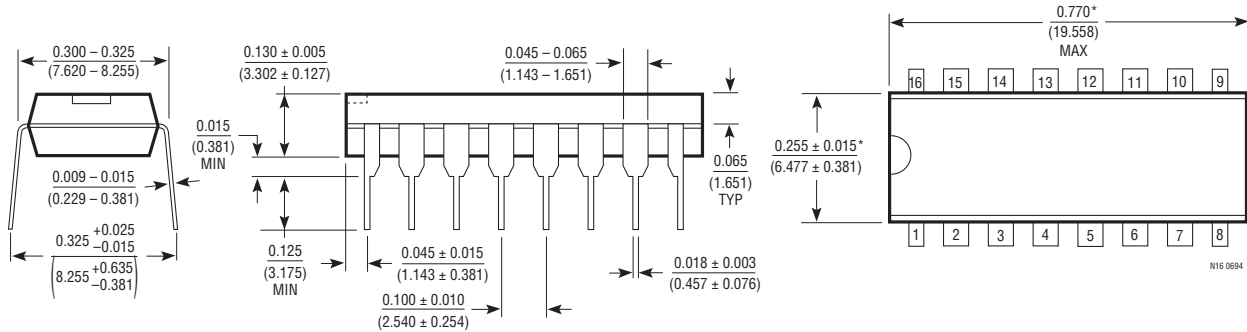

Figure 11. Low Slew Rate Mode

PACKAGE DESCRIPTION

Dimensions in inches (millimeters) unless otherwise noted.

N Package 16-Lead PDIP (Narrow 0.300) (LTC DWG # 05-08-1510)



*THESE DIMENSIONS DO NOT INCLUDE MOLD FLASH OR PROTRUSIONS.
MOLD FLASH OR PROTRUSIONS SHALL NOT EXCEED 0.010 INCH (0.254mm).

SW Package 16-Lead Plastic Small Outline (Wide 0.300) (LTC DWG # 05-08-1620)

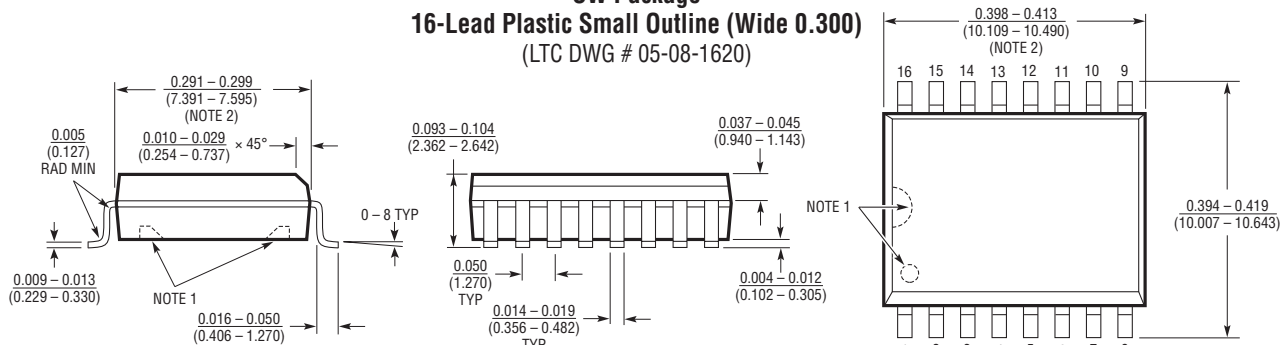

NOTE:
1. PIN 1 IDENT, NOTCH ON TOP AND CAVITIES ON THE BOTTOM OF PACKAGES ARE THE MANUFACTURING OPTIONS.
THE PART MAY BE SUPPLIED WITH OR WITHOUT ANY OF THE OPTIONS.
2. THESE DIMENSIONS DO NOT INCLUDE MOLD FLASH OR PROTRUSIONS.
MOLD FLASH OR PROTRUSIONS SHALL NOT EXCEED 0.006 INCH (0.15mm).

RELATED PARTS

PART NUMBER	DESCRIPTION	COMMENTS
LTC1318	Single 5V Powered RS232/RS422 Transceiver	Pin Selectable RS232/RS422 Receiver. Available in 24-Pin SO Wide Package
LTC1320	RS422/RS562 Transceiver	Available in 18-Pin SO Wide Package
LTC1323	Single 5V Powered RS422/RS562 Transceiver	Available in 16-Pin and 24-Pin SO Wide Packages

1324fa