

5V Low Power RS232 3-Driver/5-Receiver Transceiver with 5 Receivers Active in Shutdown

FEATURES

- **Low Supply Current: 300 μ A**
- **Five Receivers Kept Alive in Shutdown**
- ESD Protection Over ± 10 kV
- Operates from a Single 5V Supply
- Uses Small Capacitors: 0.1 μ F
- Operates to 120kBaud
- Three-State Outputs Are High Impedance When Off
- Output Overvoltage Does Not Force Current Back into Supplies
- RS232 I/O Lines Can Be Forced to ± 25 V Without Damage
- Pin Compatible with LT1137 and LT1237
- Flowthrough Architecture

APPLICATIONS

- Notebook Computers
- Palmtop Computers

DESCRIPTION

The LTC1347 is a 3-driver/5-receiver RS232 transceiver with very low supply current. In the no load condition, the supply current is only 300 μ A. The charge pump only requires four 0.1 μ F capacitors.

In Shutdown mode, all five receivers are kept alive and the supply current is 80 μ A. All RS232 outputs assume a high impedance state in Shutdown and with the power off.

The LTC1347 is fully compliant with all data rate and overvoltage RS232 specifications. The transceiver can operate up to 120kbaud with a 2500pF, 3k Ω load. Both driver outputs and receiver inputs can be forced to ± 25 V without damage, and can survive multiple ± 10 kV ESD strikes.

TYPICAL APPLICATION

3-Drivers/5-Receivers with SHUTDOWN

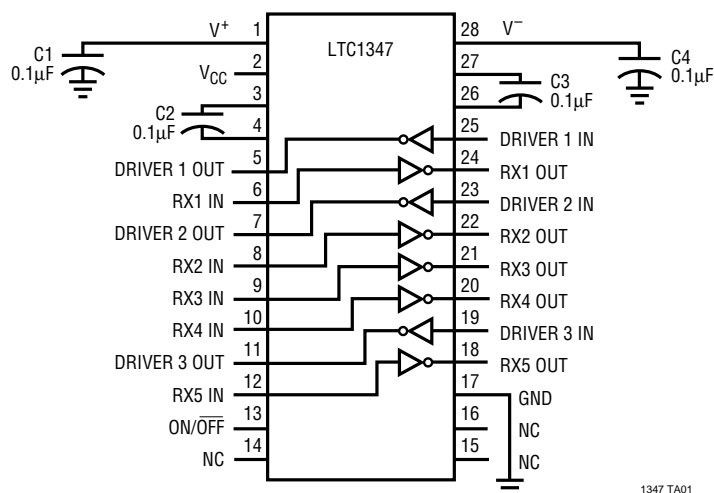

1347 TA01

Quiescent and Shutdown Supply Current vs Temperature

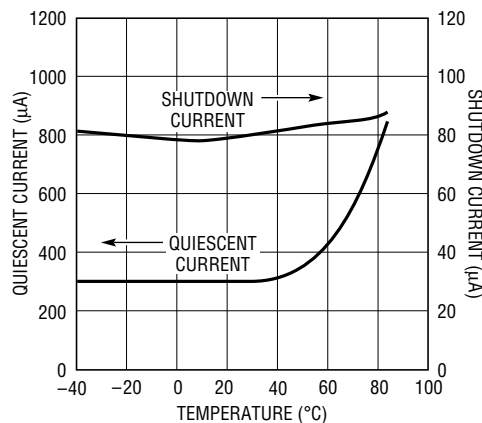

TEST CONDITION:
V_{CC} = 5V, ALL DRIVER INPUTS TIED TO V_{CC}.

1347 TA02

ABSOLUTE MAXIMUM RATINGS

Supply Voltage (V_{CC})	6V
Input Voltage	
Driver	-0.3V to $V_{CC} + 0.3V$
Receiver	-25V to 25V
On/Off Pin	-0.3V to $V_{CC} + 0.3V$
Output Voltage	
Driver	-25V to 25V
Receiver	-0.3V to $V_{CC} + 0.3V$
Short-Circuit Duration	
V^+	30 sec
V^-	30 sec
Driver Output	Indefinite
Receiver Output	Indefinite
Operating Temperature Range	0°C to 70°C
Storage Temperature Range	-65°C to 150°C
Lead Temperature (Soldering, 10 sec)	300°C

PACKAGE/ORDER INFORMATION

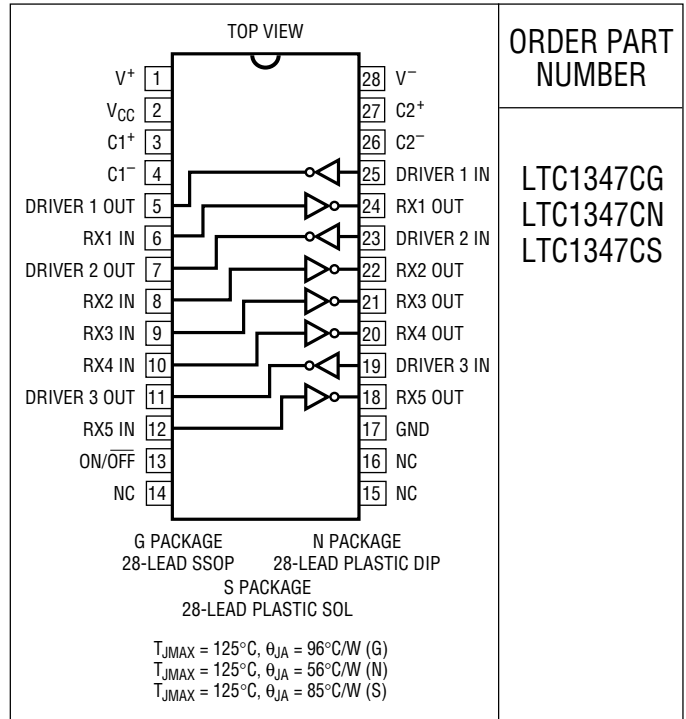

ORDER PART NUMBER

LTC1347CG
LTC1347CN
LTC1347CS

Consult factory for Industrial and Military grade parts.

DC ELECTRICAL CHARACTERISTICS $V_{CC} = 5V$, $C1 = C2 = C3 = C4 = 0.1\mu F$, unless otherwise noted.

PARAMETER	CONDITIONS	MIN	TYP	MAX	UNITS		
Any Driver							
Output Voltage Swing	3k to GND	Positive Negative	● ●	5.0 -5.0	7.0 -6.5	V V	
Logic Input Voltage Level	Input Low Level ($V_{OUT} = \text{High}$) Input High Level ($V_{OUT} = \text{Low}$)	● ●	● ●	2.0	1.4 1.4	0.8 V V	
Logic Input Current	$V_{IN} = 5V$ $V_{IN} = 0V$	● ●			5 -5	μA μA	
Output Short-Circuit Current	$V_{OUT} = 0V$				± 12	mA	
Output Leakage Current	Shutdown, $V_{OUT} = \pm 20V$ (Note 3)				± 10 ± 500	μA	
Any Receiver							
Input Voltage Thresholds	Input Low Threshold Input High Threshold	● ●	● ●	0.8	1.3 1.7	2.4 V V	
Hysteresis		●	●	0.1	0.4	1.0	V
Input Resistance	$V_{IN} = \pm 10V$			3	5	7	k Ω
Output Voltage	Output Low, $I_{OUT} = -1.6mA$ ($V_{CC} = 5V$) Output High, $I_{OUT} = 160\mu A$ ($V_{CC} = 5V$)	● ●	● ●	3.5	0.2 4.8	0.4 V V	
Output Short-Circuit Current	Sinking Current, $V_{OUT} = V_{CC}$ Sourcing Current, $V_{OUT} = 0V$			-15	-40	mA mA	
				10	20		

DC ELECTRICAL CHARACTERISTICS $V_{CC} = 5V, C1 = C2 = C3 = C4 = 0.1\mu F$, unless otherwise noted.

PARAMETER	CONDITIONS	MIN	TYP	MAX	UNITS
Power Supply Generator					
V ⁺ Output Voltage	$I_{OUT} = 0mA$		8.0		V
	$I_{OUT} = 12mA$		7.5		V
V ⁻ Output Voltage	$I_{OUT} = 0mA$		-8.0		V
	$I_{OUT} = -12mA$		-7.0		V
Supply Rise Time	Shutdown to Turn-On		0.2		ms
Power Supply					
V _{CC} Supply Current	No Load (All Drivers V _{IN} = 5V) (Note 2)	●	0.6	1.1	mA
	No Load (All Drivers V _{IN} = 0V) (Note 2)	●	0.8	1.3	mA
	Shutdown (Note 3)	●	80.0	120.0	μA
On/Off Threshold Low		●	1.4	0.8	V
On/Off Threshold High		●	2.0	1.4	V

AC CHARACTERISTICS $V_{CC} = 5V, C1 = C2 = C3 = C4 = 0.1\mu F$, unless otherwise noted.

PARAMETER	CONDITIONS	MIN	TYP	MAX	UNITS
Slew Rate	$R_L = 3k, C_L = 51pF$		8	30	V/μs
	$R_L = 3k, C_L = 2500pF$	3	5		V/μs
Driver Propagation Delay (TTL to RS232)	t_{HLD} (Figure 1)	●	2	3.5	μs
	t_{LHD} (Figure 1)	●	2	3.5	μs
Receiver Propagation Delay (RS232 to TTL)	t_{HLR} (Figure 2)	●	0.3	0.8	μs
	t_{LHR} (Figure 2)	●	0.2	0.8	μs

The ● denotes specifications which apply over the operating temperature range ($0^{\circ}C \leq T_A \leq 70^{\circ}C$ for commercial grade).

Note 1: Absolute maximum ratings are those values beyond which the life of the device may be impaired.

Note 2: Supply current is measured with driver and receiver outputs unloaded.

Note 3: Supply current and leakage current measurements in Shutdown are performed with $V_{ON/OFF} = 0V$.

TYPICAL PERFORMANCE CHARACTERISTICS

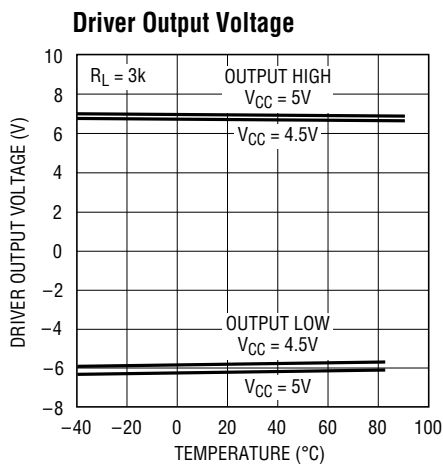

1347 G01

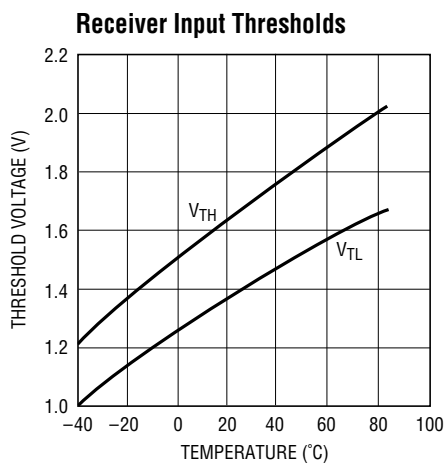

1347 G02

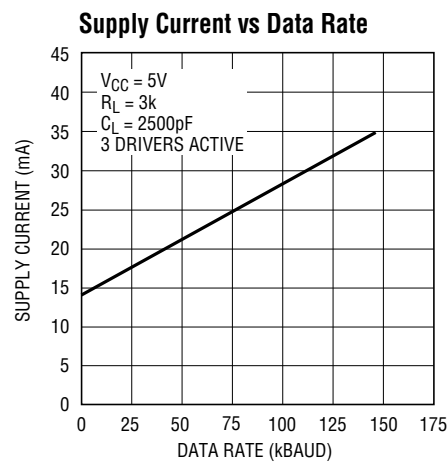

1347 G03

TYPICAL PERFORMANCE CHARACTERISTICS

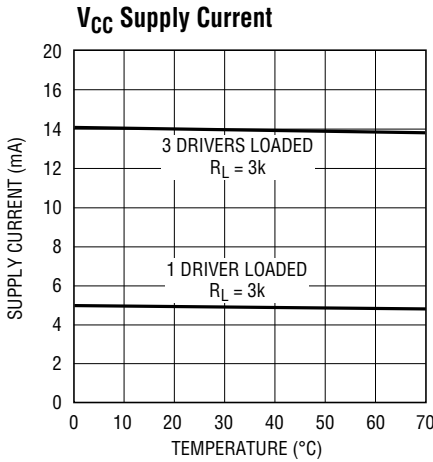

1347 G04

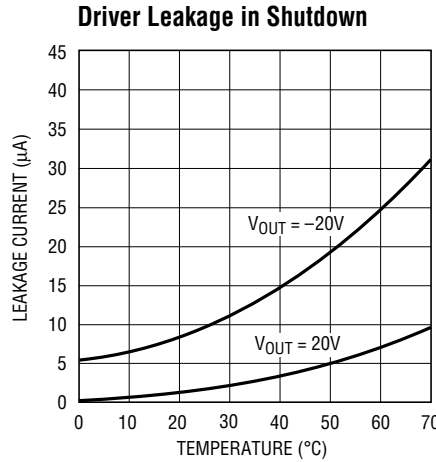

1347 G05

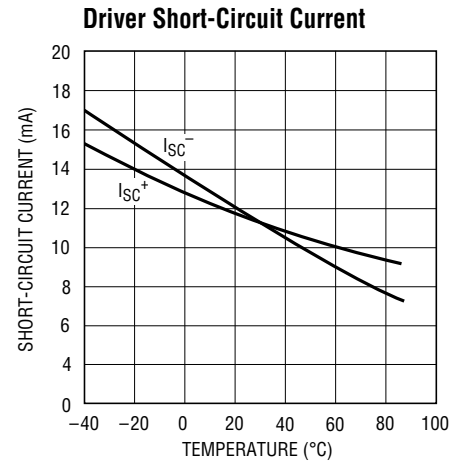

1347 G06

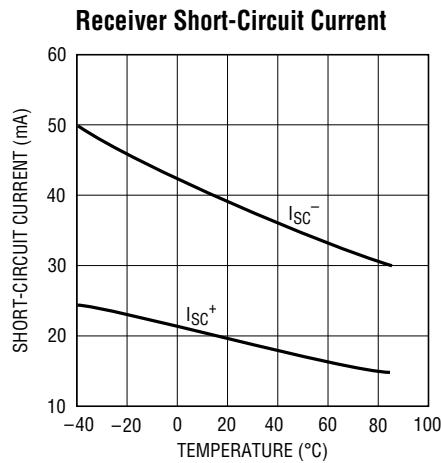

1347 G07

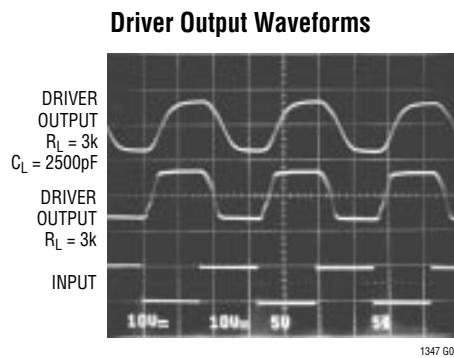

1347 G08

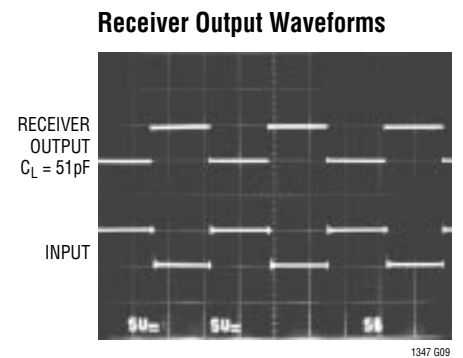

1347 G09

PIN FUNCTIONS

V_{CC}: 5V Input Supply Pin. Supply current is typically 80µA in the Shutdown mode. This pin should be decoupled with a 0.1µF ceramic capacitor.

GND: Ground Pin.

ON/OFF: TTL/CMOS Compatible Shutdown Pin. A logic low puts the device in the shutdown mode with all receivers kept alive, and the supply current is 80µA. All driver outputs are in high impedance state. This pin cannot float.

V⁺: Positive Supply Output (RS232 Drivers). V⁺ ≅ 2V_{CC} - 1V. This pin requires an external capacitor C

= 0.1µF for charge storage. The capacitor may be tied to ground or V_{CC}. With multiple devices, the V⁺ and V⁻ pins may be paralleled into common capacitors. For large numbers of devices, increasing the size of the shared common storage capacitors is recommended to reduce ripple.

V⁻: Negative Supply Output (RS232 Drivers). V⁻ ≅ -(2V_{CC} - 1.5V). This pin requires an external capacitor C = 0.1µF for charge storage.

PIN FUNCTIONS

C1⁺, C1⁻, C2⁺, C2⁻: Commutating Capacitor Inputs. These pins require two external capacitors $C = 0.1\mu\text{F}$: one from C1⁺ to C1⁻, and another from C2⁺ to C2⁻. To maintain charge pump efficiency, the capacitor's effective series resistance should be less than 2Ω .

DRIVER IN: RS232 Driver Input Pins. Inputs are TTL/CMOS compatible. Inputs should not be allowed to float. Tie unused inputs to V_{CC} .

DRIVER OUT: Driver Outputs at RS232 Voltage Levels. Outputs are in a high impedance state when in shutdown

mode or $V_{CC} = 0\text{V}$. The driver outputs are protected against ESD to $\pm 10\text{kV}$ for human body model discharges.

RX IN: Receiver Inputs. These pins can be forced to $\pm 25\text{V}$ without damage. The receiver inputs are protected against ESD to $\pm 10\text{kV}$ for human body model discharges. Each receiver provides 0.4V of hysteresis for noise immunity.

RX OUT: Receiver Outputs with TTL/CMOS Voltage Levels. All receivers are kept alive in shutdown.

SWITCHING TIME WAVEFORMS

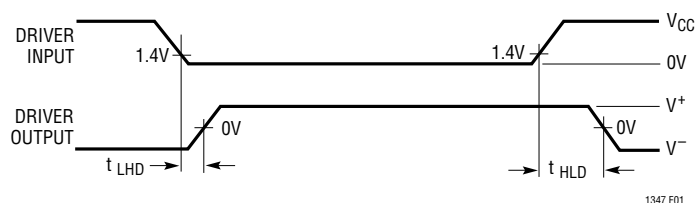

Figure 1. Driver Propagation Delay Timing

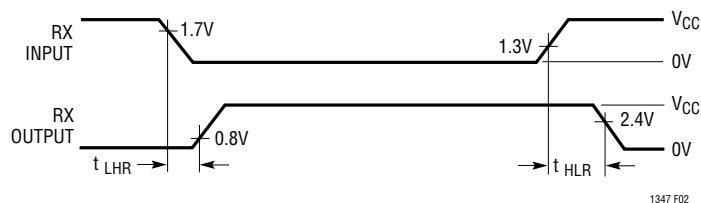

Figure 2. Receiver Propagation Delay Timing

TEST CIRCUITS

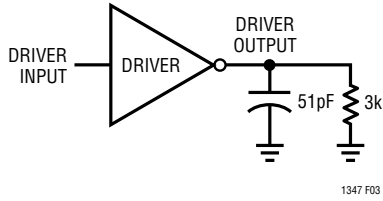

Figure 3. Driver Timing Test Load

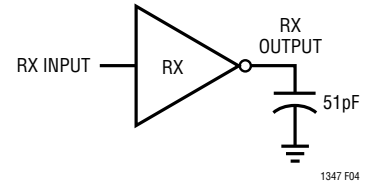

Figure 4. Receiver Timing Test Load

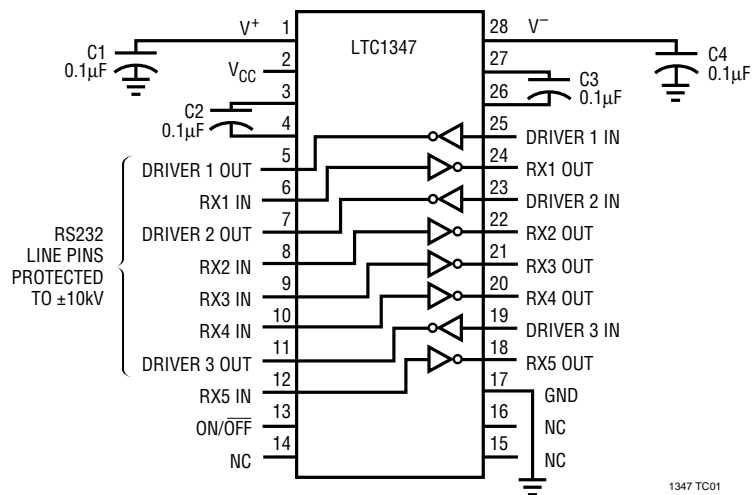
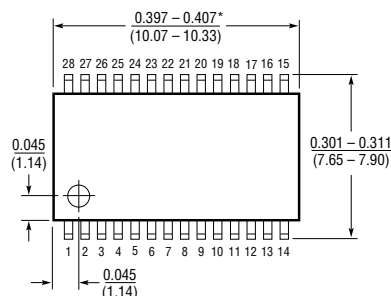
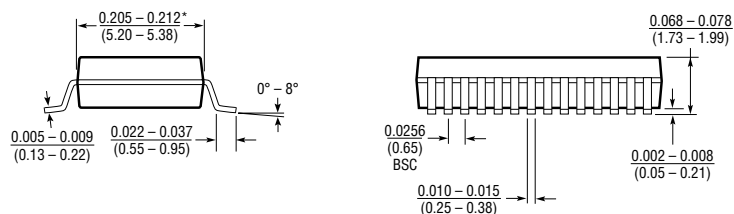

Figure 5. ESD Test Circuit

PACKAGE DESCRIPTION Dimensions in inches (millimeters) unless otherwise noted.

**G Package
28-Lead SSOP**



*THESE DIMENSIONS DO NOT INCLUDE MOLD FLASH OR PROTRUSIONS.
MOLD FLASH OR PROTRUSIONS SHALL NOT EXCEED 0.006 INCH (0.15mm).

**N Package
28-Lead Plastic DIP**

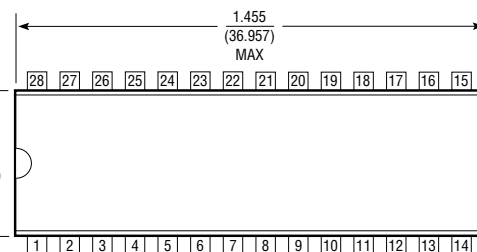
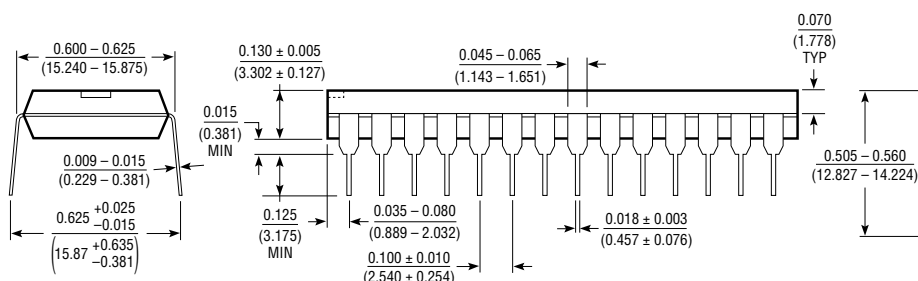

**S Package
28-Lead Plastic SOL**

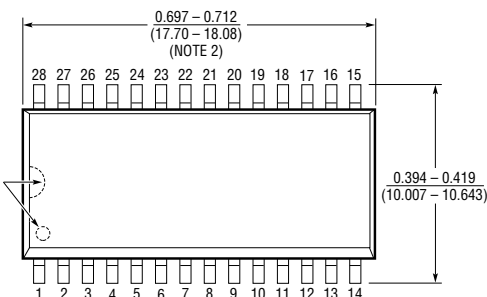
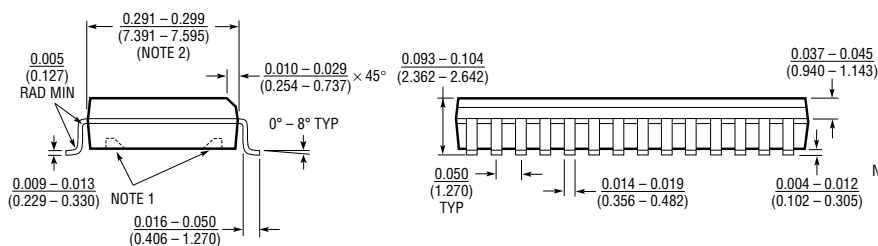

- NOTE:
- PIN 1 IDENT, NOTCH ON TOP AND CAVITIES ON THE BOTTOM OF PACKAGES ARE THE MANUFACTURING OPTIONS. THE PART MAY BE SUPPLIED WITH OR WITHOUT ANY OF THE OPTIONS.
 - THESE DIMENSIONS DO NOT INCLUDE MOLD FLASH OR PROTRUSIONS. MOLD FLASH OR PROTRUSIONS SHALL NOT EXCEED 0.006 INCH (0.15mm).

U.S. Area Sales Offices**NORTHEAST REGION****Linear Technology Corporation**

One Oxford Valley
2300 E. Lincoln Hwy., Suite 306
Langhorne, PA 19047
Phone: (215) 757-8578
FAX: (215) 757-5631

Linear Technology Corporation

266 Lowell St., Suite B-8
Wilmington, MA 01887
Phone: (508) 658-3881
FAX: (508) 658-2701

SOUTHEAST REGION**Linear Technology Corporation**

17060 Dallas Parkway
Suite 208
Dallas, TX 75248
Phone: (214) 733-3071
FAX: (214) 380-5138

CENTRAL REGION**Linear Technology Corporation**

Chesapeake Square
229 Mitchell Court, Suite A-25
Addison, IL 60101
Phone: (708) 620-6910
FAX: (708) 620-6977

SOUTHWEST REGION**Linear Technology Corporation**

22141 Ventura Blvd.
Suite 206
Woodland Hills, CA 91364
Phone: (818) 703-0835
FAX: (818) 703-0517

NORTHWEST REGION**Linear Technology Corporation**

782 Sycamore Dr.
Milpitas, CA 95035
Phone: (408) 428-2050
FAX: (408) 432-6331

International Sales Offices**FRANCE****Linear Technology S.A.R.L.**

Immeuble "Le Quartz"
58 Chemin de la Justice
92290 Chatenay Malabry
France
Phone: 33-1-41079555
FAX: 33-1-46314613

GERMANY**Linear Technolgy GmbH**

Untere Hauptstr. 9
D-85386 Eching
Germany
Phone: 49-89-3197410
FAX: 49-89-3194821

JAPAN**Linear Technology KK**

5F YZ Bldg.
4-4-12 Iidabashi, Chiyoda-Ku
Tokyo, 102 Japan
Phone: 81-3-3237-7891
FAX: 81-3-3237-8010

KOREA**Linear Technology Korea Branch**

Namsong Building, #505
Itaewon-Dong 260-199
Yongsan-Ku, Seoul
Korea
Phone: 82-2-792-1617
FAX: 82-2-792-1619

SINGAPORE**Linear Technology Pte. Ltd.**

101 Boon Keng Road
#02-15 Kallang Ind. Estates
Singapore 1233
Phone: 65-293-5322
FAX: 65-292-0398

TAIWAN**Linear Technology Corporation**

Rm. 801, No. 46, Sec. 2
Chung Shan N. Rd.
Taipei, Taiwan, R.O.C.
Phone: 886-2-521-7575
FAX: 886-2-562-2285

UNITED KINGDOM**Linear Technology (UK) Ltd.**

The Coliseum, Riverside Way
Camberley, Surrey GU15 3YL
United Kingdom
Phone: 44-276-677676
FAX: 44-276-64851

World Headquarters**Linear Technology Corporation**

1630 McCarthy Blvd.
Milpitas, CA 95035-7487
Phone: (408) 432-1900
FAX: (408) 434-0507