

# 16-Bit $\Delta\Sigma$ ADC with Easy Drive Input Current Cancellation and I<sup>2</sup>C Interface

## FEATURES

- Easy Drive Technology Enables Rail-to-Rail Inputs with Zero Differential Input Current
- Directly Digitizes High Impedance Sensors with Full Accuracy
- 600nV RMS Noise, Independent of V<sub>REF</sub>
- GND to V<sub>CC</sub> Input/Reference Common Mode Range
- 2-Wire I<sup>2</sup>C Interface
- Simultaneous 50Hz/60Hz Rejection
- 2ppm (0.25LSB) INL, No Missing Codes
- 1ppm Offset and 15ppm Full-Scale Error
- No Latency: Digital Filter Settles in a Single Cycle
- Single Supply 2.7V to 5.5V Operation
- Internal Oscillator
- Six Addresses Available and One Global Address for Synchronization
- Available in a Tiny (3mm × 3mm) 10-Lead DFN Package

## APPLICATIONS

- Direct Sensor Digitizer
- Weight Scales
- Direct Temperature Measurement
- Strain Gauge Transducers
- Instrumentation
- Industrial Process Control
- DVMs and Meters

## DESCRIPTION

The LTC<sup>®</sup>2483 combines a 16-bit plus sign No Latency  $\Delta\Sigma$ <sup>™</sup> analog-to-digital converter with patented Easy Drive<sup>™</sup> technology and I<sup>2</sup>C digital interface. The patented sampling scheme eliminates dynamic input current errors and the shortcomings of on-chip buffering through automatic cancellation of differential input current. This allows large external source impedances and input signals, with rail-to-rail input range to be directly digitized while maintaining exceptional DC accuracy.

The LTC2483 allows a wide common mode input range (0V to V<sub>CC</sub>) independent of the reference voltage. The reference can be as low as 100mV or can be tied directly to V<sub>CC</sub>. The noise level is 600nV RMS independent of V<sub>REF</sub>. This allows direct digitization of low level signals with 16-bit accuracy. The LTC2483 includes an on-chip trimmed oscillator, eliminating the need for external crystals or oscillators and provides 87dB rejection of 50Hz and 60Hz line frequency noise. Absolute accuracy and low drift are automatically maintained through continuous, transparent, offset and full-scale calibration.

**LT**, LTC and LT are registered trademarks of Linear Technology Corporation. No Latency  $\Delta\Sigma$  and Easy Drive are trademarks of Linear Technology Corporation. All other trademarks are the property of their respective owners. Patent Pending.

## TYPICAL APPLICATION

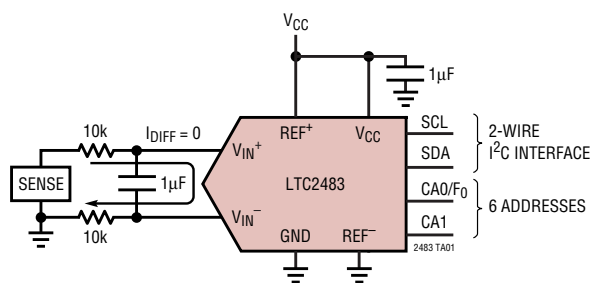

**+FS Error vs R<sub>SOURCE</sub> at IN<sup>+</sup> and IN<sup>-</sup>**

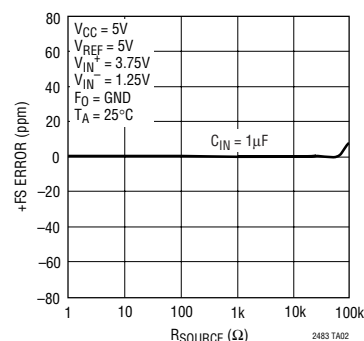

## ABSOLUTE MAXIMUM RATINGS

(Notes 1, 2)

Supply Voltage ( $V_{CC}$ ) to GND .....	-0.3V to 6V
Analog Input Voltage to GND .....	-0.3V to ( $V_{CC} + 0.3V$ )
Reference Input Voltage to GND ..	-0.3V to ( $V_{CC} + 0.3V$ )
Digital Input Voltage to GND .....	-0.3V to ( $V_{CC} + 0.3V$ )
Digital Output Voltage to GND .....	-0.3V to ( $V_{CC} + 0.3V$ )
Operating Temperature Range	
LTC2483C .....	0°C to 70°C
LTC2483I .....	-40°C to 85°C
Storage Temperature Range .....	-65°C to 125°C

## PACKAGE/ORDER INFORMATION

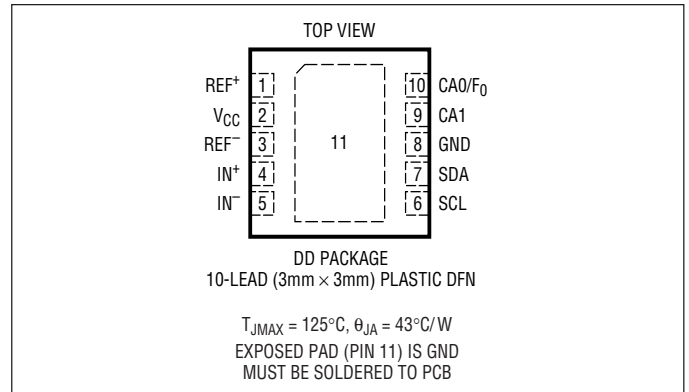

ORDER PART NUMBER	DD PART MARKING*
-------------------	------------------

LTC2483CDD LTC2483IDD	LBSR
--------------------------	------

**Order Options** Tape and Reel: Add #TR

Lead Free: Add #PBF Lead Free Tape and Reel: Add #TRPBF

Lead Free Part Marking: <http://www.linear.com/leadfree/>

Consult LTC Marketing for parts specified with wider operating temperature ranges.

\*The temperature grade is identified by a label on the shipping container.

## ELECTRICAL CHARACTERISTICS

The ● denotes the specifications which apply over the full operating temperature range, otherwise specifications are at  $T_A = 25^\circ\text{C}$ . (Notes 3, 4)

PARAMETER	CONDITIONS	MIN	TYP	MAX	UNITS
Resolution (No Missing Codes)	$0.1 \leq V_{REF} \leq V_{CC}$ , $-FS \leq V_{IN} \leq +FS$ (Note 5)	●	16		Bits
Integral Nonlinearity	$5V \leq V_{CC} \leq 5.5V$ , $V_{REF} = 5V$ , $V_{IN(CM)} = 2.5V$ (Note 6)	●	2	10	ppm of $V_{REF}$
	$2.7V \leq V_{CC} \leq 5.5V$ , $V_{REF} = 2.5V$ , $V_{IN(CM)} = 1.25V$ (Note 6)		1		ppm of $V_{REF}$
Offset Error	$2.5V \leq V_{REF} \leq V_{CC}$ , $GND \leq IN^+ = IN^- \leq V_{CC}$ (Note 13)	●	0.5	2.5	$\mu\text{V}$
Offset Error Drift	$2.5V \leq V_{REF} \leq V_{CC}$ , $GND \leq IN^+ = IN^- \leq V_{CC}$		10		$\text{nV}/^\circ\text{C}$
Positive Full-Scale Error	$2.5V \leq V_{REF} \leq V_{CC}$ , $IN^+ = 0.75V_{REF}$ , $IN^- = 0.25V_{REF}$	●		25	ppm of $V_{REF}$
Positive Full-Scale Error Drift	$2.5V \leq V_{REF} \leq V_{CC}$ , $IN^+ = 0.75V_{REF}$ , $IN^- = 0.25V_{REF}$		0.1		ppm of $V_{REF}/^\circ\text{C}$
Negative Full-Scale Error	$2.5V \leq V_{REF} \leq V_{CC}$ , $IN^- = 0.75V_{REF}$ , $IN^+ = 0.25V_{REF}$	●		25	ppm of $V_{REF}$
Negative Full-Scale Error Drift	$2.5V \leq V_{REF} \leq V_{CC}$ , $IN^- = 0.75V_{REF}$ , $IN^+ = 0.25V_{REF}$		0.1		ppm of $V_{REF}/^\circ\text{C}$
Total Unadjusted Error	$5V \leq V_{CC} \leq 5.5V$ , $V_{REF} = 2.5V$ , $V_{IN(CM)} = 1.25V$ (Note 6)		15		ppm of $V_{REF}$
	$5V \leq V_{CC} \leq 5.5V$ , $V_{REF} = 5V$ , $V_{IN(CM)} = 2.5V$ (Note 6)		15		ppm of $V_{REF}$
	$2.7V \leq V_{CC} \leq 5.5V$ , $V_{REF} = 2.5V$ , $V_{IN(CM)} = 1.25V$ (Note 6)		15		ppm of $V_{REF}$
Output Noise	$5V \leq V_{CC} \leq 5.5V$ , $V_{REF} = 5V$ , $GND \leq IN^- = IN^+ \leq V_{CC}$ (Note 12)		0.6		$\mu\text{V}_{RMS}$

## CONVERTER CHARACTERISTICS

The ● denotes the specifications which apply over the full operating temperature range, otherwise specifications are at  $T_A = 25^\circ\text{C}$ . (Notes 3, 4)

PARAMETER	CONDITIONS		MIN	TYP	MAX	UNITS
Input Common Mode Rejection DC	$2.5V \leq V_{REF} \leq V_{CC}$ , $GND \leq IN^- = IN^+ \leq V_{CC}$ (Note 5)	●	140			dB
Input Common Mode Rejection 50Hz $\pm 2\%$	$2.5V \leq V_{REF} \leq V_{CC}$ , $GND \leq IN^- = IN^+ \leq V_{CC}$ (Note 5)	●	140			dB
Input Common Mode Rejection 60Hz $\pm 2\%$	$2.5V \leq V_{REF} \leq V_{CC}$ , $GND \leq IN^- = IN^+ \leq V_{CC}$ (Note 5)	●	140			dB
Input Normal Mode Rejection 50Hz $\pm 2\%$	$2.5V \leq V_{REF} \leq V_{CC}$ , $GND \leq IN^- = IN^+ \leq V_{CC}$ (Notes 5, 7)	●	110	120		dB
Input Normal Mode Rejection 60Hz $\pm 2\%$	$2.5V \leq V_{REF} \leq V_{CC}$ , $GND \leq IN^- = IN^+ \leq V_{CC}$ (Notes 5, 8)	●	110	120		dB
Input Normal Mode Rejection 50Hz/60Hz $\pm 2\%$	$2.5V \leq V_{REF} \leq V_{CC}$ , $GND \leq IN^- = IN^+ \leq V_{CC}$ (Notes 5, 9)	●	87			dB
Reference Common Mode Rejection DC	$2.5V \leq V_{REF} \leq V_{CC}$ , $GND \leq IN^- = IN^+ \leq V_{CC}$ (Note 5)	●	120	140		dB
Power Supply Rejection DC	$V_{REF} = 2.5V$ , $IN^- = IN^+ = GND$			120		dB
Power Supply Rejection, 50Hz $\pm 2\%$	$V_{REF} = 2.5V$ , $IN^- = IN^+ = GND$ (Notes 7, 9)			120		dB
Power Supply Rejection, 60Hz $\pm 2\%$	$V_{REF} = 2.5V$ , $IN^- = IN^+ = GND$ (Notes 8, 9)			120		dB

## ANALOG INPUT AND REFERENCE

The ● denotes the specifications which apply over the full operating temperature range, otherwise specifications are at  $T_A = 25^\circ\text{C}$ . (Note 3)

SYMBOL	PARAMETER	CONDITIONS		MIN	TYP	MAX	UNITS
$IN^+$	Absolute/Common Mode $IN^+$ Voltage			$GND - 0.3V$		$V_{CC} + 0.3V$	V
$IN^-$	Absolute/Common Mode $IN^-$ Voltage			$GND - 0.3V$		$V_{CC} + 0.3V$	V
FS	Full Scale of the Differential Input ( $IN^+ - IN^-$ )		●	$0.5V_{REF}$			V
LSB	Least Significant Bit of the Output Code		●	$FS/2^{16}$			
$V_{IN}$	Input Differential Voltage Range ( $IN^+ - IN^-$ )		●	-FS		+FS	V
$V_{REF}$	Reference Voltage Range ( $REF^+ - REF^-$ )		●	0.1		$V_{CC}$	V
$C_S (IN^+)$	$IN^+$ Sampling Capacitance				11		pF
$C_S (IN^-)$	$IN^-$ Sampling Capacitance				11		pF
$C_S (V_{REF})$	$V_{REF}$ Sampling Capacitance				11		pF
$I_{DC\_LEAK} (IN^+)$	$IN^+$ DC Leakage Current	Sleep Mode, $IN^+ = GND$	●	-10	1	10	nA
$I_{DC\_LEAK} (IN^-)$	$IN^-$ DC Leakage Current	Sleep Mode, $IN^- = GND$	●	-10	1	10	nA
$I_{DC\_LEAK} (V_{REF})$	$REF^+$ , $REF^-$ DC Leakage Current	Sleep Mode, $V_{REF} = V_{CC}$	●	-100	1	100	nA

## I<sup>2</sup>C DIGITAL INPUTS AND DIGITAL OUTPUTS

The ● denotes the specifications which apply over the full operating temperature range, otherwise specifications are at T<sub>A</sub> = 25°C. (Note 3)

SYMBOL	PARAMETER	CONDITIONS	MIN	TYP	MAX	UNITS
V <sub>IH</sub>	High Level Input Voltage		●	0.7V <sub>CC</sub>		V
V <sub>IL</sub>	Low Level Input Voltage		●		0.3V <sub>CC</sub>	V
V <sub>IL(CA1)</sub>	Low Level Input Voltage for Address Pin		●		0.05V <sub>CC</sub>	V
V <sub>IH(CA0/F0,CA1)</sub>	High Level Input Voltage for Address Pins		●	0.95V <sub>CC</sub>		V
R <sub>INH</sub>	Resistance from CA0/F <sub>0</sub> ,CA1 to V <sub>CC</sub> to Set Chip Address Bit to 1		●		10	kΩ
R <sub>INL</sub>	Resistance from CA1 to GND to Set Chip Address Bit to 0		●		10	kΩ
R <sub>INF</sub>	Resistance from CA0/F <sub>0</sub> , CA1 to V <sub>CC</sub> or GND to Set Chip Address Bit to Float		●	2		MΩ
I <sub>I</sub>	Digital Input Current		●	-10	10	μA
V <sub>HYS</sub>	Hysteresis of Schmitt Trigger Inputs	(Note 5)		0.05V <sub>CC</sub>		V
V <sub>OL</sub>	Low Level Output Voltage SDA	I = 3mA	●		0.4	V
t <sub>OF</sub>	Output Fall Time from V <sub>IHMIN</sub> to V <sub>ILMAX</sub>	Bus Load C <sub>B</sub> 10pF to 400pF (Note 14)	●	20+0.1C <sub>B</sub>	250	ns
t <sub>SP</sub>	Input Spike Suppression		●		50	ns
I <sub>IN</sub>	Input Leakage	0.1V <sub>CC</sub> ≤ V <sub>IN</sub> ≤ V <sub>CC</sub>	●		1	μA
C <sub>I</sub>	Capacitance for Each I/O Pin		●	10		pF
C <sub>B</sub>	Capacitance Load for Each Bus Line		●		400	pF
C <sub>CAX</sub>	External Capacitive Load on Chip Address Pins (CA0/F <sub>0</sub> ,CA1) for Valid Float		●		10	pF
V <sub>IH(EXT,OSC)</sub>	High Level CA0/F <sub>0</sub> External Oscillator	2.7V ≤ V <sub>CC</sub> < 5.5V	●	V <sub>CC</sub> - 0.5V		V
V <sub>IL(EXT,OSC)</sub>	Low Level CA0/F <sub>0</sub> External Oscillator	2.7V ≤ V <sub>CC</sub> < 5.5V	●		0.5	V

## POWER REQUIREMENTS

The ● denotes the specifications which apply over the full operating temperature range, otherwise specifications are at T<sub>A</sub> = 25°C. (Note 3)

SYMBOL	PARAMETER	CONDITIONS	MIN	TYP	MAX	UNITS
V <sub>CC</sub>	Supply Voltage		●	2.7	5.5	V
I <sub>CC</sub>	Supply Current	Conversion Mode (Note 11)	●	160	250	μA
		Sleep Mode (Note 11)	●	1	2	μA

## TIMING CHARACTERISTICS

The ● denotes the specifications which apply over the full operating temperature range, otherwise specifications are at  $T_A = 25^\circ\text{C}$ . (Note 3)

SYMBOL	PARAMETER	CONDITIONS	MIN	TYP	MAX	UNITS
$f_{\text{EOSC}}$	External Oscillator Frequency Range	●	10		4000	kHz
$t_{\text{HEO}}$	External Oscillator High Period	●	0.125		100	$\mu\text{s}$
$t_{\text{LEO}}$	External Oscillator Low Period	●	0.125		100	$\mu\text{s}$
$t_{\text{CONV}_1}$	Conversion Time	Simultaneous 50Hz/60Hz External Oscillator (Note 10) ●	144.1	146.9 41036/ $f_{\text{EOSC}}$	149.9	ms ms

## I<sup>2</sup>C TIMING CHARACTERISTICS

The ● denotes the specifications which apply over the full operating temperature range, otherwise specifications are at  $T_A = 25^\circ\text{C}$ . (Notes 3, 15)

SYMBOL	PARAMETER	CONDITIONS	MIN	TYP	MAX	UNITS
$f_{\text{SCL}}$	SCL Clock Frequency	●	0		400	kHz
$t_{\text{HD(SDA)}}$	Hold Time (Repeated) START Condition	●	0.6			$\mu\text{s}$
$t_{\text{LOW}}$	LOW Period of the SCL Clock Pin	●	1.3			$\mu\text{s}$
$t_{\text{HIGH}}$	HIGH Period of the SCL Clock Pin	●	0.6			$\mu\text{s}$
$t_{\text{SU(STA)}}$	Set-Up Time for a Repeated START Condition	●	0.6			$\mu\text{s}$
$t_{\text{HD(DAT)}}$	Data Hold Time	●	0		0.9	$\mu\text{s}$
$t_{\text{SU(DAT)}}$	Data Set-Up Time	●	100			ns
$t_r$	Rise Time for Both SDA and SCL Signals	(Note 14) ●	$20+0.1C_B$		300	ns
$t_f$	Fall Time for Both SDA and SCL Signals	(Note 14) ●	$20+0.1C_B$		300	ns
$t_{\text{SU(STO)}}$	Set-Up Time for STOP Condition	●	0.6			$\mu\text{s}$

**Note 1:** Absolute Maximum Ratings are those values beyond which the life of the device may be impaired.

**Note 2:** All voltage values are with respect to GND.

**Note 3:**  $V_{\text{CC}} = 2.7\text{V}$  to  $5.5\text{V}$  unless otherwise specified.

$$V_{\text{REF}} = \text{REF}^+ - \text{REF}^-, V_{\text{REFCM}} = (\text{REF}^+ + \text{REF}^-)/2, \text{FS} = 0.5V_{\text{REF}}$$

$$V_{\text{IN}} = \text{IN}^+ - \text{IN}^-, V_{\text{INCM}} = (\text{IN}^+ + \text{IN}^-)/2.$$

**Note 4:** Use internal conversion clock or external conversion clock source with  $f_{\text{EOSC}} = 307.2\text{kHz}$  unless otherwise specified.

**Note 5:** Guaranteed by design, not subject to test.

**Note 6:** Integral nonlinearity is defined as the deviation of a code from a straight line passing through the actual endpoints of the transfer curve. The deviation is measured from the center of the quantization band.

**Note 7:**  $50\text{Hz } f_{\text{EOSC}} = 256\text{kHz} \pm 2\%$  (external oscillator).

**Note 8:**  $60\text{Hz } f_{\text{EOSC}} = 307.2\text{kHz} \pm 2\%$  (external oscillator).

**Note 9:** Simultaneous 50Hz/60Hz (internal oscillator) or  $f_{\text{EOSC}} = 280\text{kHz} \pm 2\%$  (external oscillator).

**Note 10:** The external oscillator is connected to the CA0/F<sub>0</sub> pin. The external oscillator frequency,  $f_{\text{EOSC}}$ , is expressed in kHz.

**Note 11:** The converter uses the internal oscillator.

**Note 12:** The output noise includes the contribution of the internal calibration operations.

**Note 13:** Guaranteed by design and test correlation.

**Note 14:**  $C_B$  = capacitance of one bus line in pF.

**Note 15:** All values refer to  $V_{\text{IH(MIN)}}$  and  $V_{\text{IL(MAX)}}$  levels.

# TYPICAL PERFORMANCE CHARACTERISTICS

**Integral Nonlinearity**  
( $V_{CC} = 5V$ ,  $V_{REF} = 5V$ )

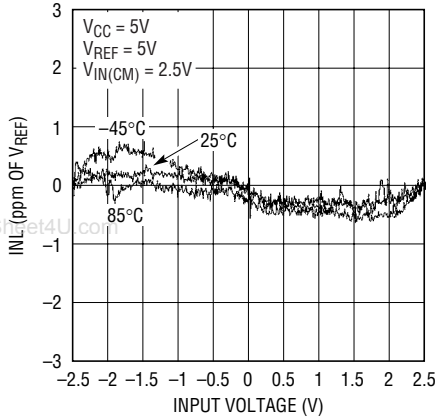

2483 G01

**Integral Nonlinearity**  
( $V_{CC} = 5V$ ,  $V_{REF} = 2.5V$ )

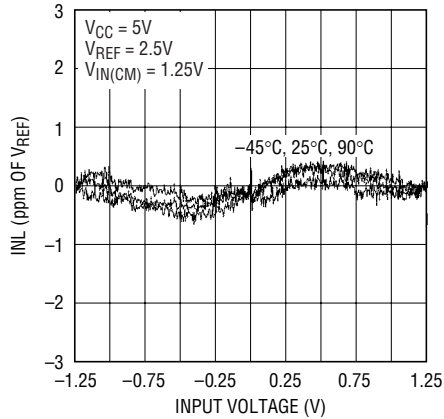

2483 G02

**Integral Nonlinearity**  
( $V_{CC} = 2.7V$ ,  $V_{REF} = 2.5V$ )

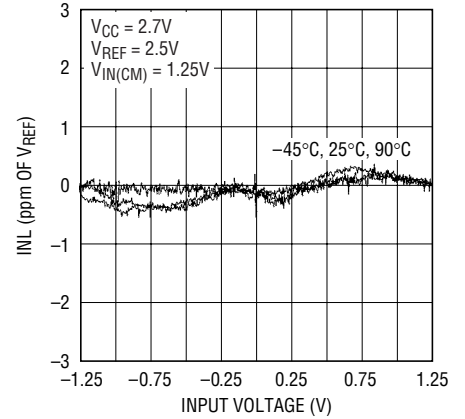

2483 G03

**Total Unadjusted Error**  
( $V_{CC} = 5V$ ,  $V_{REF} = 5V$ )

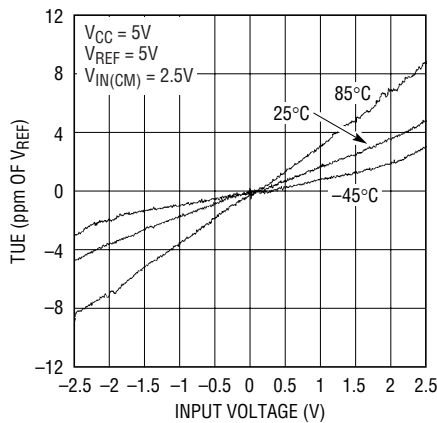

2483 G04

**Total Unadjusted Error**  
( $V_{CC} = 5V$ ,  $V_{REF} = 2.5V$ )

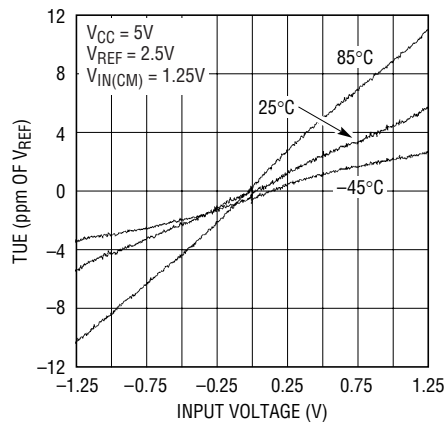

2483 G05

**Total Unadjusted Error**  
( $V_{CC} = 2.7V$ ,  $V_{REF} = 2.5V$ )

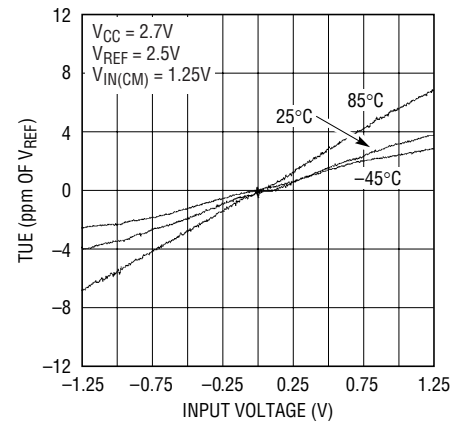

2483 G06

**Noise Histogram (6.8sps)**

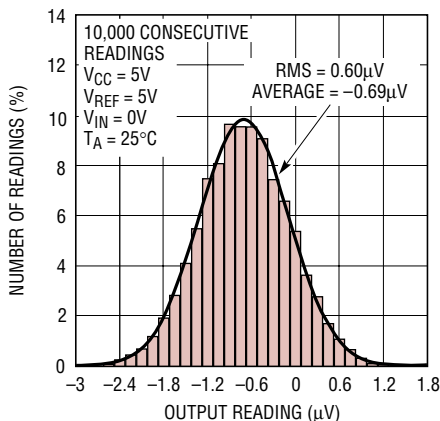

2483 G07

**Noise Histogram (7.5sps)**

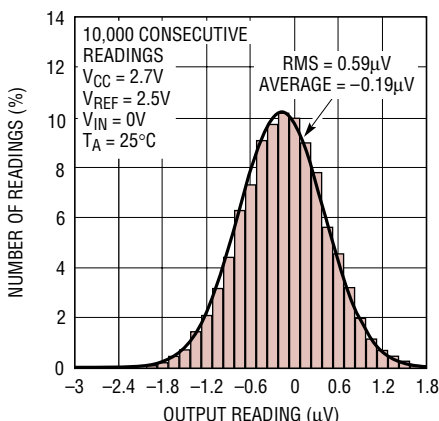

2483 G08

**Long-Term ADC Readings**

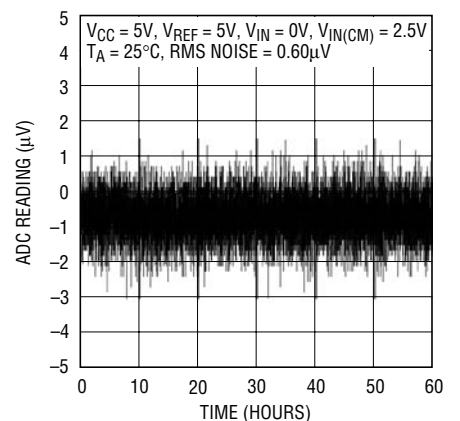

2483 G09

2483f

# TYPICAL PERFORMANCE CHARACTERISTICS

**RMS Noise vs Input Differential Voltage**

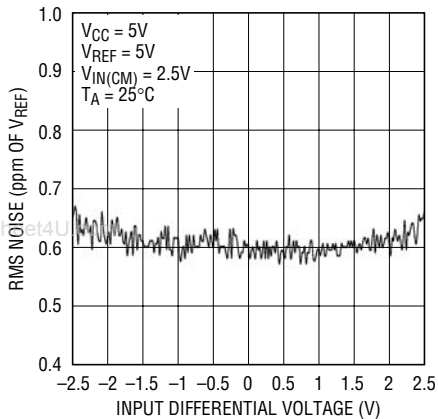

2483 G10

**RMS Noise vs  $V_{IN(CM)}$**

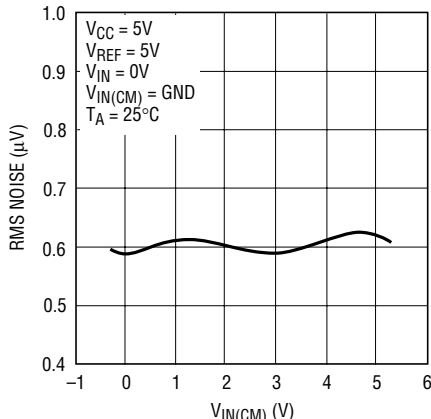

2483 G11

**RMS Noise vs Temperature ( $T_A$ )**

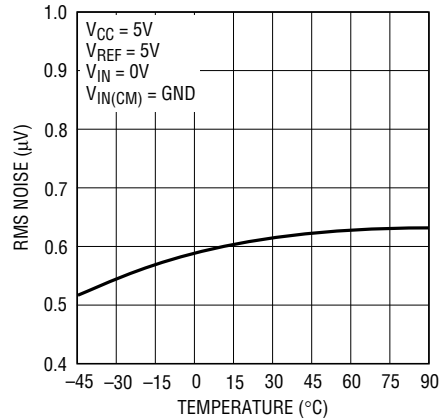

2483 G12

**RMS Noise vs  $V_{CC}$**

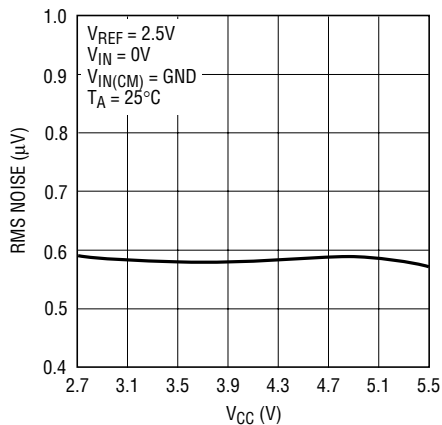

2483 G13

**RMS Noise vs  $V_{REF}$**

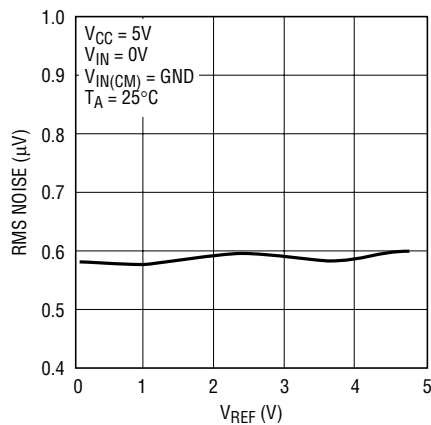

2483 G14

**Offset Error vs  $V_{IN(CM)}$**

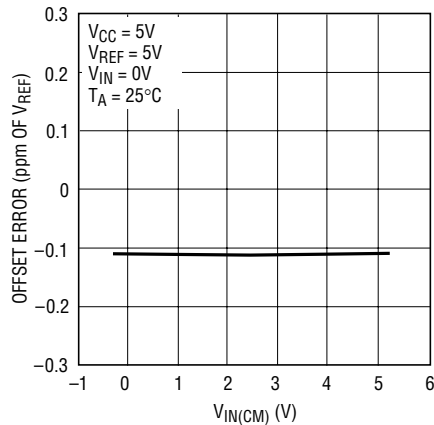

2483 G15

**Offset Error vs Temperature**

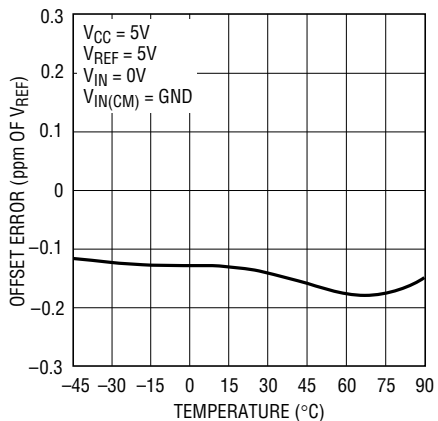

2483 G16

**Offset Error vs  $V_{CC}$**

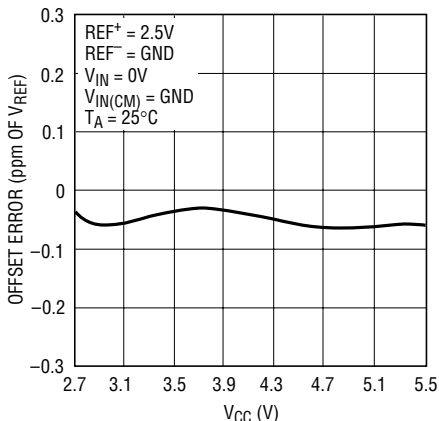

2483 G17

**Offset Error vs  $V_{REF}$**

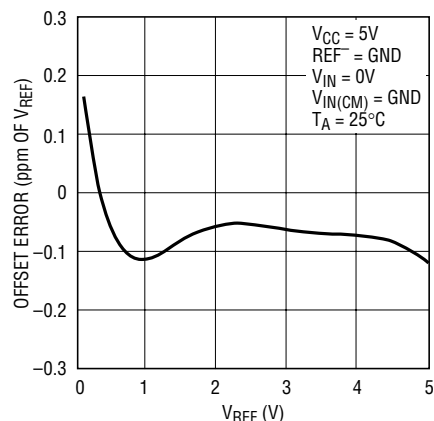

2483 G18

2483f

# TYPICAL PERFORMANCE CHARACTERISTICS

**On-Chip Oscillator Frequency vs Temperature**

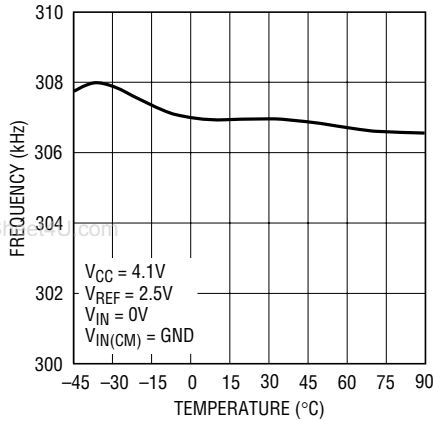

2483 G21

**On-Chip Oscillator Frequency vs VCC**

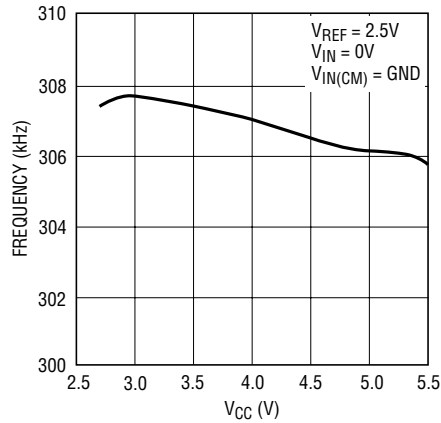

2483 G22

**PSRR vs Frequency at VCC**

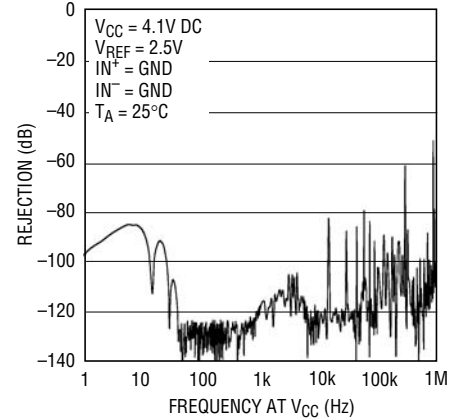

2483 G23

**PSRR vs Frequency at VCC**

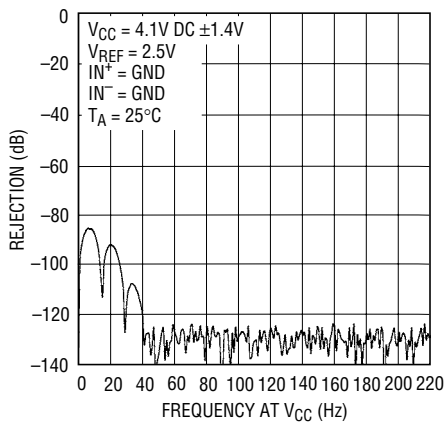

2483 G24

**PSRR vs Frequency at VCC**

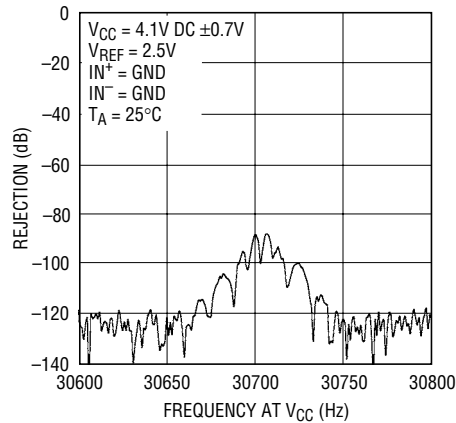

2483 G25

**Conversion Current vs Temperature**

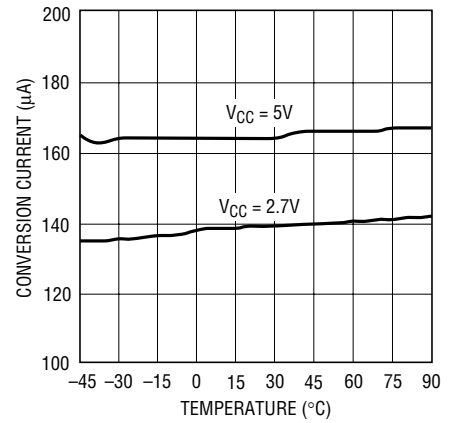

2483 G26

**Sleep Mode Current vs Temperature**

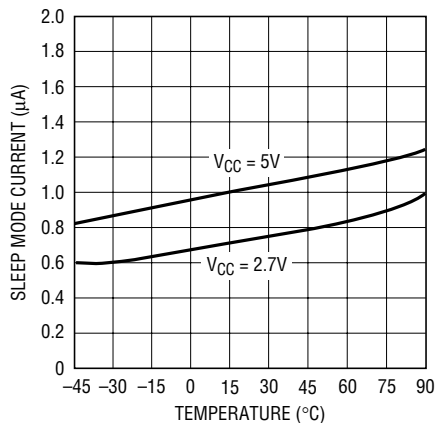

2483 G27

**Conversion Current vs Output Data Rate**

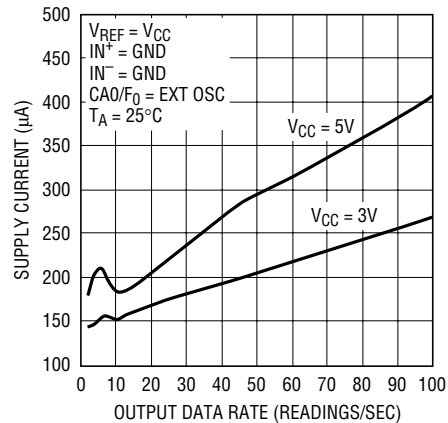

2483 G28



## PIN FUNCTIONS

**REF<sup>+</sup> (Pin 1), REF<sup>-</sup> (Pin 3):** Differential Reference Input. The voltage on these pins can have any value between GND and  $V_{CC}$  as long as the reference positive input, REF<sup>+</sup>, is more positive than the reference negative input, REF<sup>-</sup>, by at least 0.1V.

**V<sub>CC</sub> (Pin 2):** Positive Supply Voltage. Bypass to GND (Pin 8) with a 1 $\mu$ F tantalum capacitor in parallel with 0.1 $\mu$ F ceramic capacitor as close to the part as possible.

**IN<sup>+</sup> (Pin 4), IN<sup>-</sup> (Pin 5):** Differential Analog Input. The voltage on these pins can have any value between  $GND - 0.3V$  and  $V_{CC} + 0.3V$ . Within these limits the converter bipolar input range ( $V_{IN} = IN^+ - IN^-$ ) extends from  $-0.5 \cdot V_{REF}$  to  $0.5 \cdot V_{REF}$ . Outside this input range the converter produces unique overrange and underrange output codes.

**SCL (Pin 6):** Serial Clock Pin of the I<sup>2</sup>C Interface. The LTC2483 can only act as a slave and the SCL pin only accepts external serial clock. Data is shifted out the SDA pin on the falling edges of the SCL clock.

**SDA (Pin 7):** Serial Data Output Line of the I<sup>2</sup>C Interface. In the transmitter mode (Read), the conversion result is output through the SDA pin. It is an open-drain N-channel driver and therefore an external pull-up resistor or current source to  $V_{CC}$  is needed.

**GND (Pin 8):** Ground. Connect this pin to a ground plane through a low impedance connection.

**CA1 (Pin 9):** Chip Address Control Pin. The CA1 pin is configured as a three state (LOW, HIGH, or Floating) address control bit for the device I<sup>2</sup>C address.

**CA0/F<sub>0</sub> (Pin 10):** Chip Address Control Pin/External Clock Input Pin. When no transition is detected on the CA0/F<sub>0</sub> pin, it is a two state (HIGH or Floating) address control bit for the device I<sup>2</sup>C address. When the pin is driven by an external clock signal with a frequency  $f_{EOSC}$  of at least 10kHz, the converter uses this signal as its system clock and the fundamental digital filter rejection null is located at a frequency  $f_{EOSC}/5120$  and sets the Chip Address CA0 internally to a HIGH.

# FUNCTIONAL BLOCK DIAGRAM

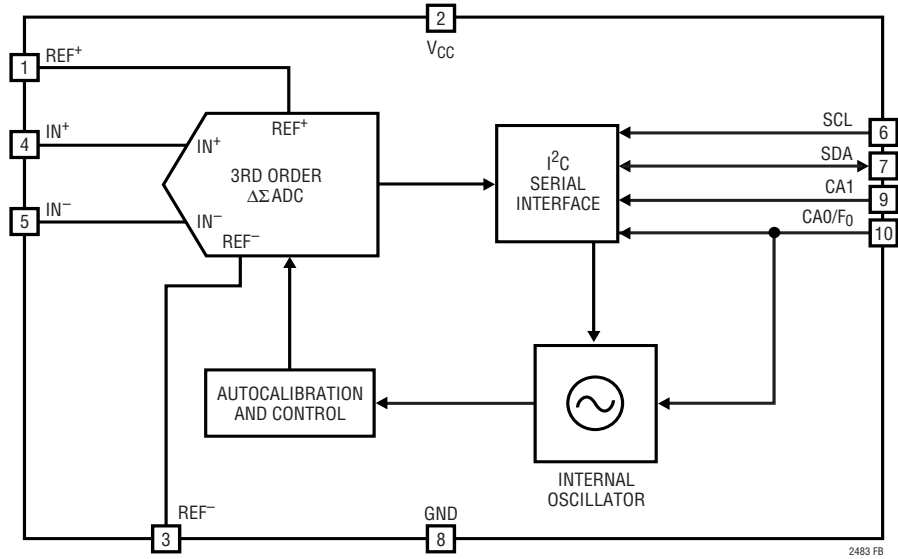

www.DataSheet4U.com

## APPLICATIONS INFORMATION

### CONVERTER OPERATION

#### Converter Operation Cycle

The LTC2483 is a low power,  $\Delta\Sigma$  analog-to-digital converter with an I<sup>2</sup>C interface. After power on reset, its operation is made up of three states. The converter operating cycle begins with the conversion, followed by the low power sleep state and ends with the data output (see Figure 1).

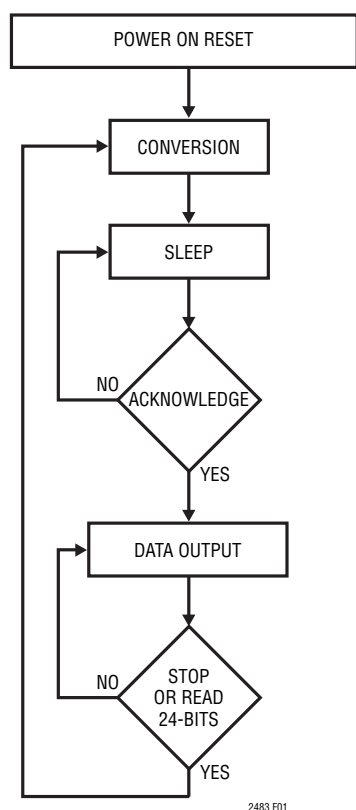

Figure 1. LTC2483 State Transition Diagram

Initially, the LTC2483 performs a conversion. Once the conversion is complete, the device enters the sleep state. While in this sleep state, power consumption is reduced by two orders of magnitude. The part remains in the sleep state as long as it is not addressed for a read operation. The conversion result is held indefinitely in a static shift register while the converter is in the sleep state.

The device will not acknowledge an external request during the conversion state. After a conversion is finished, the device is ready to accept a read request. Once the

LTC2483 is addressed for a read operation, the device begins outputting the conversion result under control of the serial clock (SCL). There is no latency in the conversion result. The data output is 24 bits long and contains a 16-bit plus sign conversion result. This result is shifted out on the SDA pin under the control of the SCL. Data is updated on the falling edges of SCL allowing the user to reliably latch data on the rising edge of SCL. A new conversion is initiated at the conclusion of a data read operation (read out all 24 bits).

### I<sup>2</sup>C INTERFACE

The LTC2483 communicates through an I<sup>2</sup>C interface. The I<sup>2</sup>C interface is a 2-wire open-drain interface supporting multiple devices and masters on a single bus. The connected devices can only pull the bus wires LOW and they never drive the bus HIGH. The bus wires are externally connected to a positive supply voltage via a current-source or pull-up resistor. When the bus is free, both lines are HIGH. Data on the I<sup>2</sup>C-bus can be transferred at rates of up to 100kbit/s in the Standard-mode and up to 400kbit/s in the Fast-mode.

Each device on the I<sup>2</sup>C bus is recognized by a unique address stored in that device and can operate as either a transmitter or receiver, depending on the function of the device. In addition to transmitters and receivers, devices can also be considered as masters or slaves when performing data transfers. A master is the device which initiates a data transfer on the bus and generates the clock signals to permit that transfer. At the same time any device addressed is considered a slave.

The LTC2483 can only be addressed as a slave. Once addressed, it can transmit the last conversion result. Therefore the serial clock line SCL is an input only and the data line SDA is bidirectional (data out/address in). The device supports the Standard-mode and the Fast-mode for data transfer speeds up to 400kbit/s. Figure 2 shows the definition of timing for Fast/Standard-mode devices on the I<sup>2</sup>C-bus.

## APPLICATIONS INFORMATION

### The START and STOP Conditions

A START condition is generated by transitioning SDA from HIGH to LOW while SCL is HIGH. The bus is considered to be busy after the START condition. When the data transfer is finished, a STOP condition is generated by transitioning SDA from LOW to HIGH while SCL is HIGH. The bus is free again a certain time after the STOP condition. START and STOP conditions are always generated by the master.

When the bus is in use, it stays busy if a repeated START (Sr) is generated instead of a STOP condition. The repeated START (Sr) conditions are functionally identical to the START (S).

### Data Transferring

After the START condition, the I<sup>2</sup>C bus is busy and data transfer is set between a master and a slave. Data is transferred over I<sup>2</sup>C in groups of nine bits (one byte) followed by an acknowledge bit, therefore each group takes nine SCL cycles. The transmitter releases the SDA line during the acknowledge clock pulse and the receiver issues an Acknowledge (ACK) by pulling SDA LOW or leaves SDA HIGH to indicate a Not Acknowledge (NAK) condition. Change of data state can only happen while SCL is LOW.

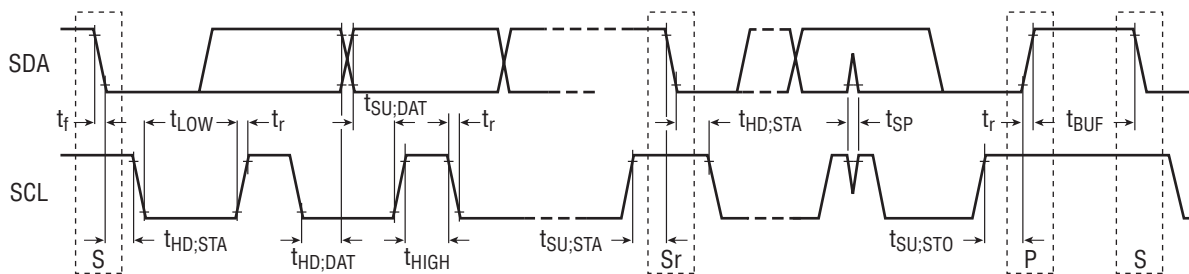

Figure 2. Definition of Timing for F/S-Mode Devices on the I<sup>2</sup>C-Bus

2483 F02

## APPLICATIONS INFORMATION

### LTC2483 Data Format

After a START condition, the master sends a 7-bit address followed by a R/W bit. The bit R/W is 1 for a Read request and 0 for a Write request. If the 7-bit address agrees with an LTC2483's address, that device is selected. When the device is in the conversion state, it does not accept the request and issues a Not-Acknowledge (NAK) by leaving SDA HIGH. A write operation will also generate an NAK signal. If the conversion is complete, it issues an acknowledge (ACK) by pulling SDA LOW.

The output register contains the last conversion result. After each conversion is completed, the device automatically enters the sleep state where the supply current is reduced to  $1\mu\text{A}$ . When the LTC2483 is addressed for a Read operation, it acknowledges (by pulling SDA LOW) and acts as a transmitter. The master and receiver can read up to three bytes from the LTC2483. After a complete Read operation (3 bytes), the output register is emptied, a new conversion is initiated, and a following Read request in the same output phase will be NAKed. The LTC2483 output data stream is 24 bits long, shifted out on the falling edges of SCL. The first bit is the conversion result sign bit (SIG), see Tables 1 and 2. This bit is HIGH if  $V_{\text{IN}} \geq 0$ . It is LOW if  $V_{\text{IN}} < 0$ . The second bit is the most significant bit (MSB) of the result. The first two bits (SIG and MSB) can be used to

indicate over range conditions. If both bits are HIGH, the differential input voltage is above +FS and the following 16 bits are set to LOW to indicate an overrange condition. If both bits are LOW, the input voltage is below -FS and the following 16 bits are set to HIGH to indicate an underrange condition. The function of these two bits is summarized in Table 1. The next 16 bits contain the conversion results in binary two's complement format. The remaining six bits are LOW.

**Table 1. LTC2483 Status Bits**

INPUT RANGE	BIT 23 SIG	BIT 22 MSB
$V_{\text{IN}} \geq 0.5 \cdot V_{\text{REF}}$	1	1
$0\text{V} \leq V_{\text{IN}} < 0.5 \cdot V_{\text{REF}}$	1	0
$-0.5 \cdot V_{\text{REF}} \leq V_{\text{IN}} < 0\text{V}$	0	1
$V_{\text{IN}} < -0.5 \cdot V_{\text{REF}}$	0	0

As long as the voltage on the  $\text{IN}^+$  and  $\text{IN}^-$  pins is maintained within the  $-0.3\text{V}$  to  $(V_{\text{CC}} + 0.3\text{V})$  absolute maximum operating range, a conversion result is generated for any differential input voltage  $V_{\text{IN}}$  from  $-\text{FS} = -0.5 \cdot V_{\text{REF}}$  to  $+\text{FS} = 0.5 \cdot V_{\text{REF}}$ . For differential input voltages greater than +FS, the conversion result is clamped to the value corresponding to the  $+\text{FS} + 1\text{LSB}$ . For differential input voltages below -FS, the conversion result is clamped to the value corresponding to  $-\text{FS} - 1\text{LSB}$ .

**Table 2. LTC2483 Output Data Format**

DIFFERENTIAL INPUT VOLTAGE $V_{\text{IN}}^*$	BIT 23 SIG	BIT 22 MSB	BIT 21	BIT 20	BIT 19	...	BIT 6
$V_{\text{IN}}^* \geq \text{FS}^{**}$	1	1	0	0	0	...	0
$\text{FS}^{**} - 1\text{LSB}$	1	0	1	1	1	...	1
$0.5 \cdot \text{FS}^{**}$	1	0	1	0	0	...	0
$0.5 \cdot \text{FS}^{**} - 1\text{LSB}$	1	0	0	1	1	...	1
0	1	0	0	0	0	...	0
-1LSB	0	1	1	1	1	...	1
$-0.5 \cdot \text{FS}^{**}$	0	1	1	0	0	...	0
$-0.5 \cdot \text{FS}^{**} - 1\text{LSB}$	0	1	0	1	1	...	1
$-\text{FS}^{**}$	0	1	0	0	0	...	0
$V_{\text{IN}}^* < -\text{FS}^{**}$	0	0	1	1	1	...	1

\*The differential input voltage  $V_{\text{IN}} = \text{IN}^+ - \text{IN}^-$ . \*\*The full-scale voltage  $\text{FS} = 0.5 \cdot V_{\text{REF}}$ .

## APPLICATIONS INFORMATION

### Initiating a New Conversion

When the LTC2483 finishes a conversion, it automatically enters the sleep state. Once in the sleep state, the device is ready for a Read operation. After the device acknowledges a Read request, the device exits the sleep state and enters the data output state. The data output state concludes and the LTC2483 starts a new conversion once a STOP condition is issued by the master or all 24-bits of data are read out of the device.

During the data read cycle, a stop command may be issued by the master controller in order to start a new conversion and abort the data transfer. This stop command must be issued during the 9th clock cycle of a byte read when the bus is free (the ACK/NAK cycle).

### LTC2483 Address

The LTC2483 has two address pins, enabling one in 6 possible addresses, as shown in Table 3.

**Table 3. LTC2483 Address Assignment**

CA1	CA0/F <sub>0</sub> *	Address
LOW	HIGH	001 01 00
LOW	Floating	001 01 01
Floating	HIGH	001 01 11
Floating	Floating	010 01 00
HIGH	HIGH	010 01 10
HIGH	Floating	010 01 11

\* CA0/F<sub>0</sub> is treated as HIGH when driven by a valid external clock.

### Data Read

The data read operation sequence is shown in Figure 5. When the conversion is finished, the device may be addressed for a read operation. At the end of a read operation, a new conversion begins. At the conclusion of the conversion cycle, the next result may be read using the method described above. If the conversion cycle is not concluded and a valid address selects the device, the LTC2483 generates a NAK signal indicating the conversion cycle is in progress.

### Easy Drive Input Current Cancellation

The LTC2483 combines a high precision delta-sigma ADC with an automatic differential input current cancellation front end. A proprietary front-end passive sampling network transparently removes the differential input current. This enables external RC networks and high impedance sensors to directly interface to the LTC2483 without external amplifiers. The remaining common mode input current is eliminated by either balancing the differential input impedances or setting the common mode input equal to the common mode reference (see Automatic Input Current Cancellation section). This unique architecture does not require on-chip buffers enabling input signals to swing all the way to ground and up to V<sub>CC</sub>. Furthermore, the cancellation does not interfere with the transparent offset and full-scale auto-calibration and the absolute accuracy (full scale + offset + linearity) is maintained even with external RC networks.

### Conversion Clock

A major advantage the delta-sigma converter offers over conventional type converters is an on-chip digital filter (commonly implemented as a SINC or Comb filter). For high resolution, low frequency applications, this filter is typically designed to reject line frequencies of 50Hz and 60Hz plus their harmonics. The filter rejection performance is directly related to the accuracy of the converter system clock. The LTC2483 incorporates a highly accurate on-chip oscillator. This eliminates the need for external frequency setting components such as crystals or oscillators.

## APPLICATIONS INFORMATION

### Frequency Rejection Selection (CA0/F<sub>0</sub>)

The LTC2483 internal oscillator provides better than 87dB normal mode rejection at line frequencies of 50Hz and 60Hz and all of their harmonics (up to the 255th) from 48Hz to 62.4Hz.

When a fundamental rejection frequency different from 50Hz/60Hz is required or when the converter must be synchronized with an outside source, the LTC2483 can operate with an external conversion clock.

automatically detects the presence of an external clock signal at the CA0/F<sub>0</sub> pin and turns off the internal oscillator. The chip address for CA0 is internally set HIGH. The frequency  $f_{EOSC}$  of the external signal must be at least 10kHz to be detected. The external clock signal duty cycle is not significant as long as the minimum and maximum specifications for the high and low periods  $t_{HEO}$  and  $t_{LEO}$  are observed.

While operating with an external conversion clock of a frequency  $f_{EOSC}$ , the LTC2483 provides better than 110dB

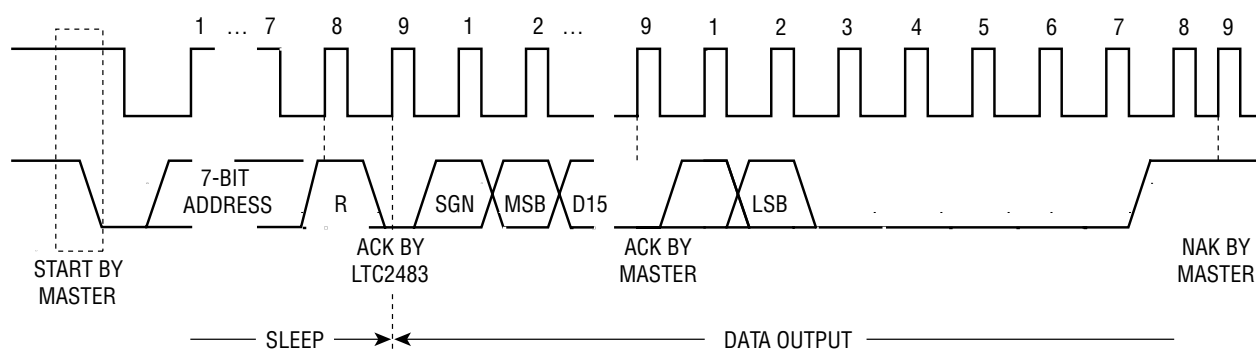

Figure 3. Timing Diagram for Reading from the LTC2483

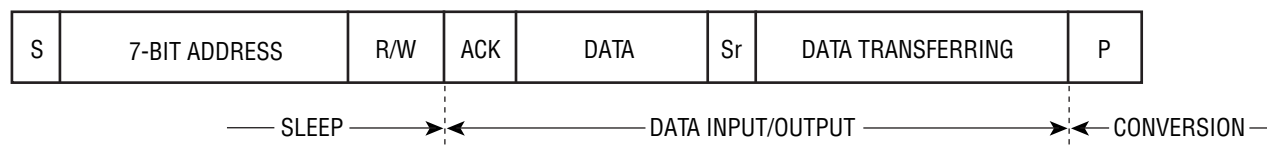

Figure 4. The LTC2483 Conversion Sequence

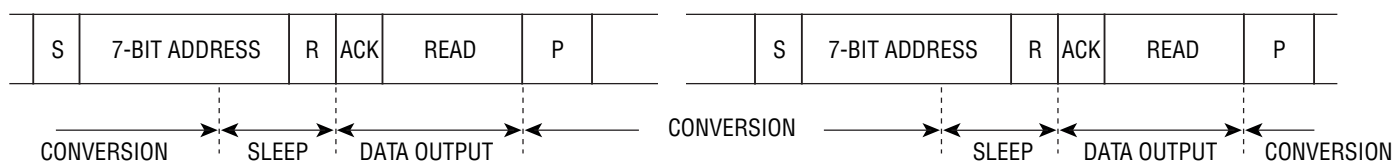
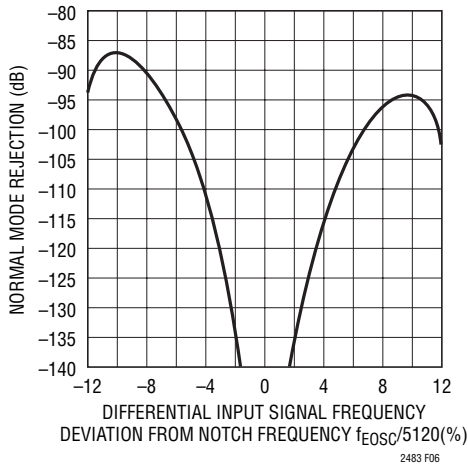

Figure 5. Consecutive Reading at the Same Configuration

## APPLICATIONS INFORMATION

normal mode rejection in a frequency range of  $f_{EOSC}/5120 \pm 4\%$  and its harmonics. The normal mode rejection as a function of the input frequency deviation from  $f_{EOSC}/5120$  is shown in Figure 6.



**Figure 6. LTC2483 Normal Mode Rejection When Using an External Oscillator**

Whenever an external clock is not present at the CA0/F<sub>0</sub> pin, the converter automatically activates its internal oscillator and enters the Internal Conversion Clock mode. CA0/F<sub>0</sub> may be tied HIGH or left floating in order to set the chip address. The LTC2483 operation will not be disturbed if the change of conversion clock source occurs during the sleep state or during the data output state while the converter uses an external serial clock. If the change occurs during the conversion state, the result of the conversion in progress may be outside specifications but the following conversions will not be affected.

Table 4 summarizes the duration of the conversion state of each state and the achievable output data rate as a function of  $f_{EOSC}$ .

**Table 4. LTC2483 State Duration**

STATE	OPERATING MODE		DURATION
CONVERSION	Internal Oscillator	50Hz/60Hz Rejection	147ms, Output Data Rate $\leq 6.8$ Readings/s
	External Oscillator	CA0/F <sub>0</sub> = External Oscillator with Frequency $f_{EOSC}$ Hz ( $f_{EOSC}/5120$ Rejection)	$41036/f_{EOSC}$ s, Output Data Rate $\leq f_{EOSC}/41036$ Readings/s

### Ease of Use

The LTC2483 data output has no latency, filter settling delay or redundant data associated with the conversion cycle. There is a one-to-one correspondence between the conversion and the output data. Therefore, multiplexing multiple analog voltages is easy.

The LTC2483 performs offset and full-scale calibrations every conversion cycle. This calibration is transparent to the user and has no effect on the cyclic operation described above. The advantage of continuous calibration is extreme stability of offset and full-scale readings with respect to time, supply voltage change and temperature drift.

### Power-Up Sequence

The LTC2483 automatically enters an internal reset state when the power supply voltage  $V_{CC}$  drops below approximately 2V. This feature guarantees the integrity of the conversion result.

When the  $V_{CC}$  voltage rises above this critical threshold, the converter creates an internal power-on-reset (POR) signal with a duration of approximately 4ms. The POR signal clears all internal registers. Following the POR signal, the LTC2483 starts a normal conversion cycle and follows the succession of states described in Figure 1. The first conversion result following POR is accurate within the specifications of the device if the power supply voltage is restored within the operating range (2.7V to 5.5V) before the end of the POR time interval.

### Reference Voltage Range

The LTC2483 external reference voltage range is 0.1V to  $V_{CC}$ . The converter output noise is determined by the



## APPLICATIONS INFORMATION

thermal noise of the front-end circuits, and as such, its value in nanovolts is nearly constant with reference voltage. Since the transition noise (600nV) is much less than the quantization noise ( $V_{REF}/2^{17}$ ), a decrease in the reference voltage will increase the converter resolution. A reduced reference voltage will also improve the converter performance when operated with an external conversion clock (external  $F_0$  signal) at substantially higher output data rates (see the Output Data Rate section).

The reference input is differential. The differential reference input range ( $V_{REF} = REF^+ - REF^-$ ) is 100mV to  $V_{CC}$  and the common mode reference input range is 0V to  $V_{CC}$ .

### Input Voltage Range

The analog input is truly differential with an absolute/common mode range for the  $IN^+$  and  $IN^-$  input pins extending from  $GND - 0.3V$  to  $V_{CC} + 0.3V$ . Outside these limits, the ESD protection devices begin to turn on and the errors due to input leakage current increase rapidly. Within these limits, the LTC2483 converts the bipolar differential input signal,  $V_{IN} = IN^+ - IN^-$ , from  $-FS$  to  $+FS$  where  $FS = 0.5 \cdot V_{REF}$ . Beyond this range, the converter indicates the overrange or the underrange condition using distinct output codes. Since the differential input current cancellation does not rely on an on-chip buffer, current cancellation and DC performance is maintained rail-to-rail.

Input signals applied to  $IN^+$  and  $IN^-$  pins may extend by 300mV below ground and above  $V_{CC}$ . In order to limit any fault current, resistors of up to 5k may be added in series with the  $IN^+$  and  $IN^-$  pins without affecting the performance of the devices. The effect of the series resistance on the converter accuracy can be evaluated from the curves presented in the Input Current/Reference Current sections. In addition, series resistors will introduce a temperature dependent offset error due to the input leakage current. A 1nA input leakage current will develop a 1ppm offset error on a 5k resistor if  $V_{REF} = 5V$ . This error has a very strong temperature dependency.

### Driving the Input and Reference

The input and reference pins of the LTC2483 converter are directly connected to a network of sampling capacitors. Depending upon the relation between the differential input voltage and the differential reference voltage, these capacitors are switching between these four pins transferring small amounts of charge in the process. A simplified equivalent circuit is shown in Figure 7.

For a simple approximation, the source impedance  $R_S$  driving an analog input pin ( $IN^+$ ,  $IN^-$ ,  $REF^+$  or  $REF^-$ ) can be considered to form, together with  $R_{SW}$  and  $C_{EQ}$  (see Figure 7), a first order passive network with a time constant  $\tau = (R_S + R_{SW}) \cdot C_{EQ}$ . The converter is able to sample the

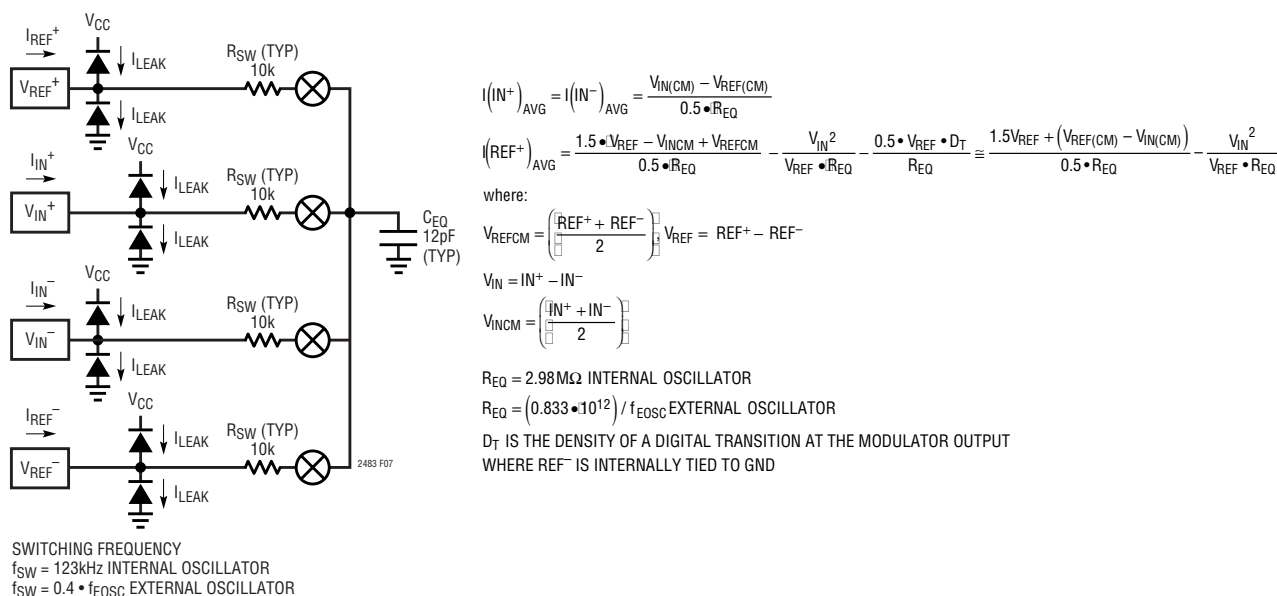

Figure 7. LTC2483 Equivalent Analog Input Circuit

## APPLICATIONS INFORMATION

input signal with better than 1ppm accuracy if the sampling period is at least 14 times greater than the input circuit time constant  $\tau$ . The sampling process on the four input analog pins is quasi-independent so each time constant should be considered by itself and, under worst-case circumstances, the errors may add.

When using the internal oscillator, the LTC2483's front-end switched-capacitor network is clocked at 123kHz corresponding to an 8.1 $\mu$ s sampling period. Thus, for settling errors of less than 1ppm, the driving source impedance should be chosen such that  $\tau \leq 8.1\mu\text{s}/14 = 580\text{ns}$ . When an external oscillator of frequency  $f_{\text{EOSC}}$  is used, the sampling period is  $2.5/f_{\text{EOSC}}$  and, for a settling error of less than 1ppm,  $\tau \leq 0.178/f_{\text{EOSC}}$ .

### Automatic Differential Input Current Cancellation

In applications where the sensor output impedance is low (up to 10k $\Omega$  with no external bypass capacitor or up to 500 $\Omega$  with 0.001 $\mu$ F bypass), complete settling of the input occurs. In this case, no errors are introduced and direct digitization of the sensor is possible.

For many applications, the sensor output impedance combined with external bypass capacitors produces RC time constants much greater than the 580ns required for 1ppm accuracy. For example, a 10k $\Omega$  bridge driving a 0.1 $\mu$ F bypass capacitor has a time constant an order of magnitude greater than the required maximum. Historically, settling issues were solved using buffers. These buffers led to increased noise, reduced DC performance (Offset/Drift), limited input/output swing (cannot digitize signals near ground or  $V_{\text{CC}}$ ), added system cost and increased power. The LTC2483 uses a proprietary switching algorithm that forces the average differential input current to zero independent of external settling errors. This allows accurate direct digitization of high impedance sensors without the need of buffers (see Figures 8 to 10). Additional errors resulting from mismatched leakage currents must also be taken into account.

The switching algorithm forces the average input current on the positive input ( $I_{\text{IN}^+}$ ) to be equal to the average input current on the negative input ( $I_{\text{IN}^-}$ ). Over the complete conversion cycle, the average differential input current ( $I_{\text{IN}^+} - I_{\text{IN}^-}$ ) is zero. While the differential input current is

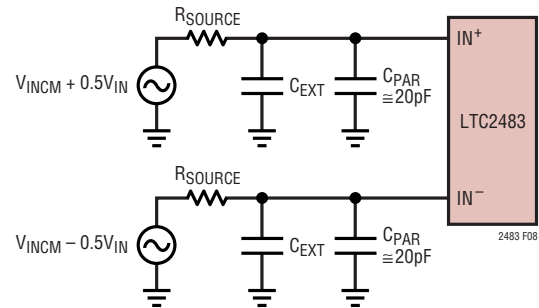

Figure 8. An RC Network at IN<sup>+</sup> and IN<sup>-</sup>

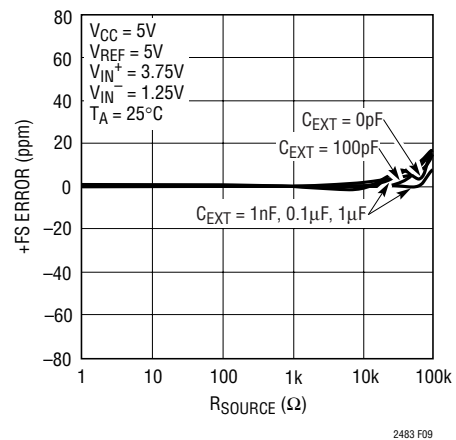

Figure 9. +FS Error vs  $R_{\text{SOURCE}}$  at IN<sup>+</sup> and IN<sup>-</sup>

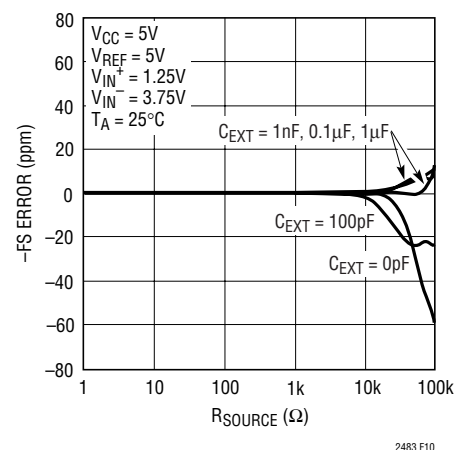

Figure 10. -FS Error vs  $R_{\text{SOURCE}}$  at IN<sup>+</sup> and IN<sup>-</sup>

## APPLICATIONS INFORMATION

zero, the common mode input current  $(I_{IN^+} + I_{IN^-})/2$  is proportional to the difference between the common mode input voltage ( $V_{INCM}$ ) and the common mode reference voltage ( $V_{REFCM}$ ).

In applications where the input common mode voltage is equal to the reference common mode voltage, as in the case of a balance bridge type application, both the differential and common mode input current are zero. The accuracy of the converter is unaffected by settling errors. Mismatches in source impedances between  $IN^+$  and  $IN^-$  also do not affect the accuracy.

In applications where the input common mode voltage is constant but different from the reference common mode voltage, the differential input current remains zero while the common mode input current is proportional to the difference between  $V_{INCM}$  and  $V_{REFCM}$ . For a reference common mode of 2.5V and an input common mode of 1.5V, the common mode input current is approximately 0.74 $\mu$ A. This common mode input current has no effect on the accuracy if the external source impedances tied to  $IN^+$  and  $IN^-$  are matched. Mismatches in these source impedances lead to a fixed offset error but do not affect the linearity or full-scale reading. A 1% mismatch in 1k $\Omega$  source resistances leads to a 15ppm shift (74 $\mu$ V) in offset voltage.

In applications where the common mode input voltage varies as a function of input signal level (single-ended input, RTDs, half bridges, current sensors, etc.), the common mode input current varies proportionally with input voltage. For the case of balanced input impedances, the common mode input current effects are rejected by the large CMRR of the LTC2483 leading to little degradation in accuracy. Mismatches in source impedances lead to gain errors proportional to the difference between the common mode input voltage and the common mode reference voltage. 1% mismatches in 1k $\Omega$  source resistances lead to worst-case gain errors on the order of 15ppm or 1LSB (for 1V differences in reference and input common mode voltage). Table 5 summarizes the effects of mismatched source impedance and differences in reference/input common mode voltages.

**Table 5. Suggested Input Configuration for LTC2483**

	BALANCED INPUT RESISTANCES	UNBALANCED INPUT RESISTANCES
Constant $V_{IN(CM)} - V_{REF(CM)}$	$C_{EXT} > 1nF$ at Both $IN^+$ and $IN^-$ . Can Take Large Source Resistance with Negligible Error	$C_{EXT} > 1nF$ at Both $IN^+$ and $IN^-$ . Can Take Large Source Resistance. Unbalanced Resistance Results in an Offset Which Can be Calibrated
Varying $V_{IN(CM)} - V_{REF(CM)}$	$C_{EXT} > 1nF$ at Both $IN^+$ and $IN^-$ . Can Take Large Source Resistance with Negligible Error	Minimize $IN^+$ and $IN^-$ Capacitors and Avoid Large Source Impedance (<5k Recommended)

The magnitude of the dynamic input current depends upon the size of the very stable internal sampling capacitors and upon the accuracy of the converter sampling clock. The accuracy of the internal clock over the entire temperature and power supply range is typically better than 0.5%. Such a specification can also be easily achieved by an external clock. When relatively stable resistors (50ppm/ $^{\circ}$ C) are used for the external source impedance seen by  $IN^+$  and  $IN^-$ , the expected drift of the dynamic current and offset will be insignificant (about 1% of their respective values over the entire temperature and voltage range). Even for the most stringent applications, a one-time calibration operation may be sufficient.

In addition to the input sampling charge, the input ESD protection diodes have a temperature dependent leakage current. This current, nominally 1nA ( $\pm 10nA$  max), results in a small offset shift. A 1k source resistance will create a 1 $\mu$ V typical and 10 $\mu$ V maximum offset voltage.

### Reference Current

In a similar fashion, the LTC2483 samples the differential reference pins  $REF^+$  and  $REF^-$  transferring small amount of charge to and from the external driving circuits thus producing a dynamic reference current. This current does not change the converter offset, but it may degrade the gain and INL performance. The effect of this current can be analyzed in two distinct situations.

For relatively small values of the external reference capacitors ( $C_{REF} < 1nF$ ), the voltage on the sampling capacitor settles almost completely and relatively large values for the source impedance result in only small errors. Such values for  $C_{REF}$  will deteriorate the converter offset and gain

2483f

## APPLICATIONS INFORMATION

performance without significant benefits of reference filtering and the user is advised to avoid them.

Larger values of reference capacitors ( $C_{REF} > 1\text{nF}$ ) may be required as reference filters in certain configurations. Such capacitors will average the reference sampling charge and the external source resistance will see a quasi constant reference differential impedance.

In the following discussion, it is assumed the input and reference common mode are the same. For the internal oscillator, the related difference resistance is  $1.1\text{M}\Omega$  and

the resulting full-scale error is  $0.46\text{ppm}$  for each ohm of source resistance driving the  $REF^+$  and  $REF^-$  pins. When  $CAO/F_0$  is driven by an external oscillator with a frequency  $f_{EOSC}$  (external conversion clock operation), the typical differential reference resistance is  $0.30 \cdot 10^{12}/f_{EOSC} \Omega$  and each ohm of source resistance driving the  $REF^+$  or  $REF^-$  pins will result in  $1.67 \cdot 10^{-6} \cdot f_{EOSC}\text{ppm}$  gain error. The typical +FS and -FS errors for various combinations of source resistance seen by the  $REF^+$  or  $REF^-$  pins and external capacitance connected to that pin are shown in Figures 11-14.

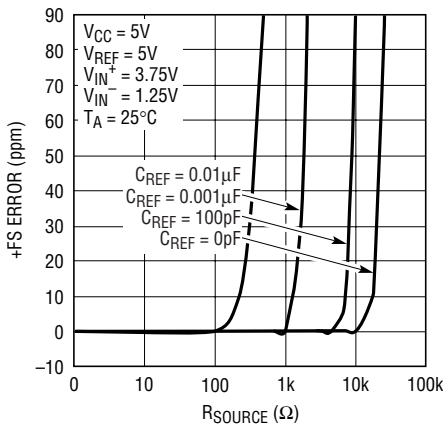

Figure 11. +FS Error vs  $R_{SOURCE}$  at  $REF^+$  or  $REF^-$  (Small  $C_{REF}$ )

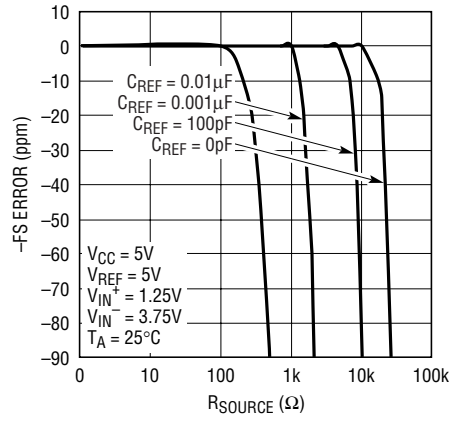

Figure 12. -FS Error vs  $R_{SOURCE}$  at  $REF^+$  or  $REF^-$  (Small  $C_{REF}$ )

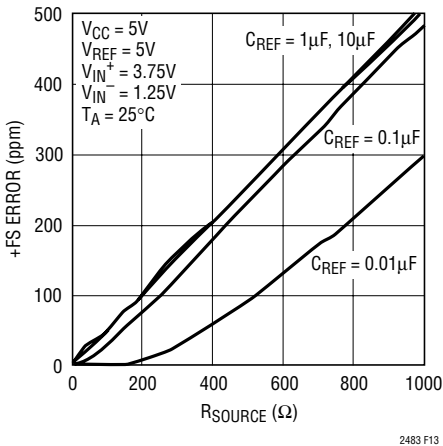

Figure 13. +FS Error vs  $R_{SOURCE}$  at  $REF^+$  or  $REF^-$  (Large  $C_{REF}$ )

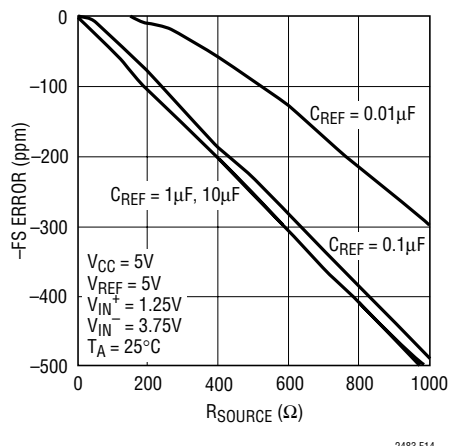

Figure 14. -FS Error vs  $R_{SOURCE}$  at  $REF^+$  or  $REF^-$  (Large  $C_{REF}$ )

## APPLICATIONS INFORMATION

In addition to this gain error, the converter INL performance is degraded by the reference source impedance. The INL is caused by the input dependent terms  $-V_{IN}^2/(V_{REF} \cdot R_{EQ}) - (0.5 \cdot V_{REF} \cdot D_T)/R_{EQ}$  in the reference pin current as expressed in Figure 7. When using internal oscillator, every  $100\Omega$  of reference source resistance translates into about 0.61ppm additional INL error. When  $CAO/F_0$  is driven by an external oscillator with a frequency  $f_{EOSC}$ , every  $100\Omega$  of source resistance driving  $REF^+$  or  $REF^-$  translates into about  $2.18 \cdot 10^{-6} \cdot f_{EOSC}$ ppm additional INL error. Figure 15 shows the typical INL error due to the source resistance driving the  $REF^+$  or  $REF^-$  pins when large  $C_{REF}$  values are used. The user is advised to minimize the source impedance driving the  $REF^+$  and  $REF^-$  pins.

In applications where the reference and input common mode voltages are different, extra errors are introduced. For every 1V of the reference and input common mode voltage difference ( $V_{REFCM} - V_{INCM}$ ) and a 5V reference, each Ohm of reference source resistance introduces an extra  $(V_{REFCM} - V_{INCM})/(V_{REF} \cdot R_{EQ})$  full-scale gain error, which is 0.067ppm when using internal oscillator. If an

external clock is used, the corresponding extra gain error is  $0.24 \cdot 10^{-6} \cdot f_{EOSC}$ ppm.

The magnitude of the dynamic reference current depends upon the size of the very stable internal sampling capacitors and upon the accuracy of the converter sampling clock. The accuracy of the internal clock over the entire temperature and power supply range is typically better than 0.5%. Such a specification can also be easily achieved by an external clock. When relatively stable resistors (50ppm/°C) are used for the external source impedance seen by  $REF^+$  and  $REF^-$ , the expected drift of the dynamic current gain error will be insignificant (about 1% of its value over the entire temperature and voltage range). Even for the most stringent applications a one-time calibration operation may be sufficient.

In addition to the reference sampling charge, the reference pins ESD protection diodes have a temperature dependent leakage current. This leakage current, nominally 1nA ( $\pm 10$ nA max), results in a small gain error. A  $100\Omega$  source resistance will create a  $0.05\mu V$  typical and  $0.5\mu V$  maximum full-scale error.

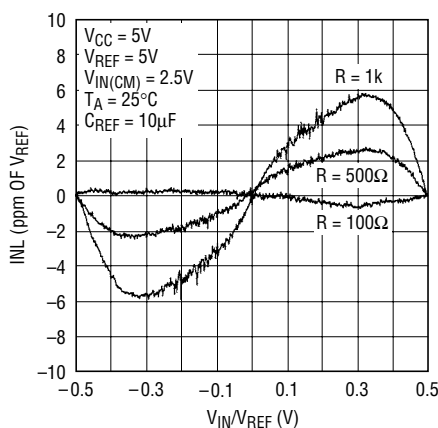

2483 F15

**Figure 15. INL vs DIFFERENTIAL Input Voltage and Reference Source Resistance for  $C_{REF} > 1\mu F$**

# APPLICATIONS INFORMATION

## Output Data Rate

When using its internal oscillator, the LTC2483 produces up to 6.82sps with simultaneous 50Hz/60Hz rejection. The actual output data rate will depend upon the length of the sleep and data output phases which are controlled by the user and which can be made insignificantly short. When operated with an external conversion clock (CA0/F<sub>0</sub> connected to an external oscillator), the LTC2483 output data rate can be increased as desired. The duration of the conversion phase is  $41036/f_{EOSC}$ . If  $f_{EOSC} = 307.2\text{kHz}$ , the converter notch is set at 60Hz.

An increase in  $f_{EOSC}$  over the nominal 307.2kHz will translate into a proportional increase in the maximum

output data rate. The increase in output rate is nevertheless accompanied by three potential effects, which must be carefully considered.

First, a change in  $f_{EOSC}$  will result in a proportional change in the internal notch position and in a reduction of the converter differential mode rejection at the power line frequency. In many applications, the subsequent performance degradation can be substantially reduced by relying upon the LTC2483's exceptional common mode rejection and by carefully eliminating common mode to differential mode conversion sources in the input circuit. The user should avoid single-ended input filters and should maintain a very high degree of matching and symmetry in the circuits driving the IN<sup>+</sup> and IN<sup>-</sup> pins.

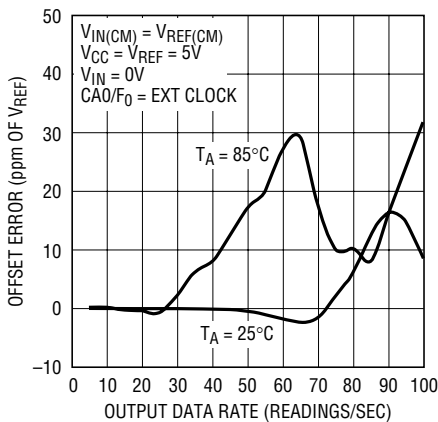

Figure 16. Offset Error vs Output Data Rate and Temperature

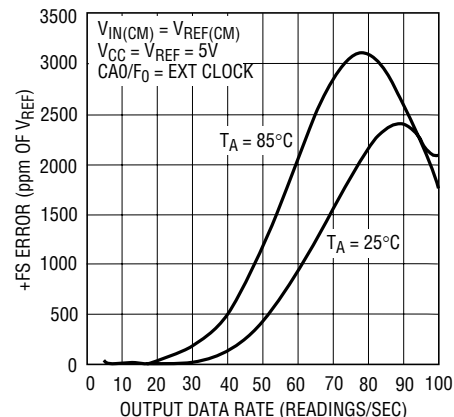

Figure 17. +FS Error vs Output Data Rate and Temperature

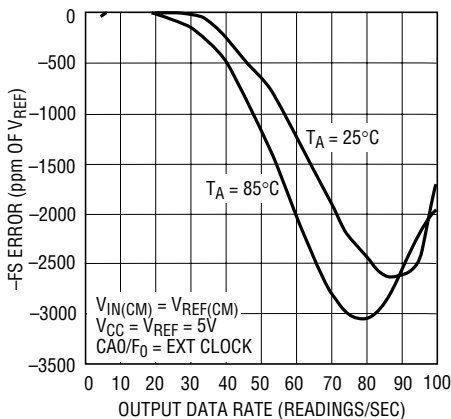

Figure 18. -FS Error vs Output Data Rate and Temperature

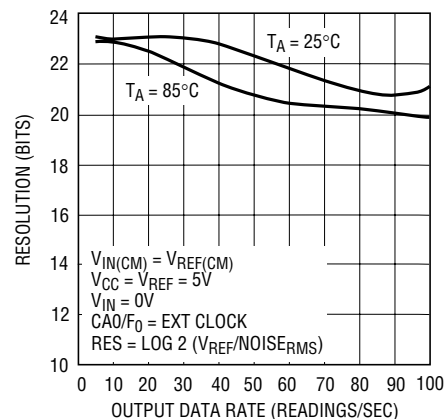

Figure 19. Resolution (Noise<sub>RMS</sub> ≤ 1LSB) vs Output Data Rate and Temperature

## APPLICATIONS INFORMATION

Second, the increase in clock frequency will increase proportionally the amount of sampling charge transferred through the input and the reference pins. If large external input and/or reference capacitors ( $C_{IN}$ ,  $C_{REF}$ ) are used, the previous section provides formulae for evaluating the effect of the source resistance upon the converter performance for any value of  $f_{EOSC}$ . If small external input and/or reference capacitors ( $C_{IN}$ ,  $C_{REF}$ ) are used, the effect of the external source resistance upon the LTC2483 typical performance can be inferred from Figures 9, 10, 11 and 12 in which the horizontal axis is scaled by  $307200/f_{EOSC}$ .

Third, an increase in the frequency of the external oscillator above 1MHz (a more than 3+ increase in the output data rate) will start to decrease the effectiveness of the internal autocalibration circuits. This will result in a progressive degradation in the converter accuracy and linearity. Typical measured performance curves for output data rates up to 100 readings per second are shown in Figures 16 to 23. In order to obtain the highest possible level of accuracy from this converter at output data rates above 20 readings per second, the user is advised to maximize the power supply voltage used and to limit the maximum ambient operating temperature. In certain circumstances, a reduction of the differential reference voltage may be beneficial.

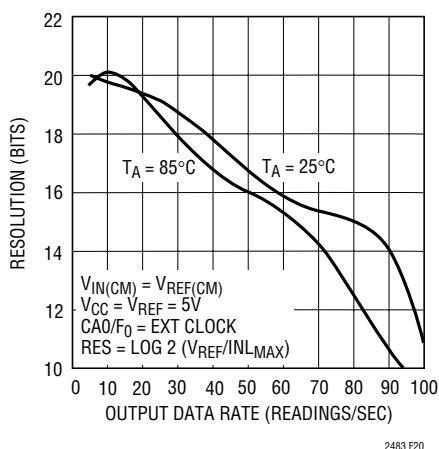

Figure 20. Resolution ( $INL_{MAX} \leq 1LSB$ ) vs Output Data Rate and Temperature

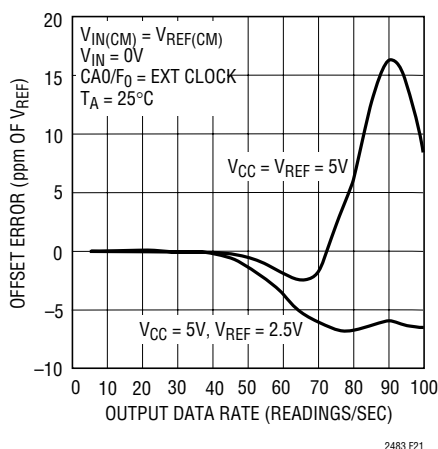

Figure 21. Offset Error vs Output Data Rate and Reference Voltage

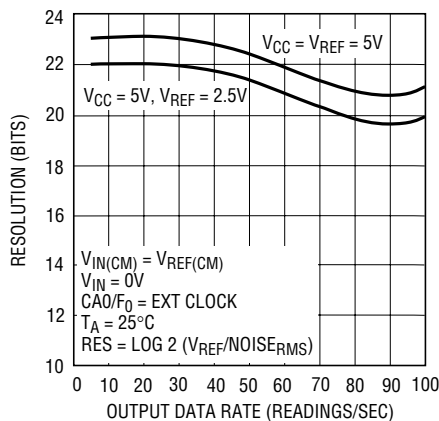

Figure 22. Resolution ( $Noise_{RMS} \leq 1LSB$ ) vs Output Data Rate and Reference Voltage

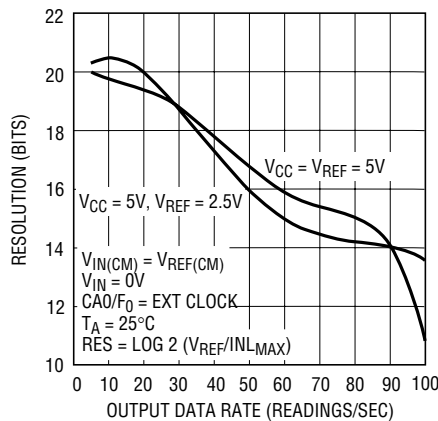

Figure 23. Resolution ( $INL_{MAX} \leq 1LSB$ ) vs Output Data Rate and Reference Voltage

## APPLICATIONS INFORMATION

### Input Bandwidth

The combined effect of the internal SINC<sup>4</sup> digital filter and of the analog and digital autocalibration circuits determines the LTC2483 input bandwidth. When the internal oscillator is used, the 3dB input bandwidth is 3.3Hz. If an external conversion clock generator of frequency  $f_{\text{EOSC}}$  is connected to the CA0/F<sub>0</sub> pin, the 3dB input bandwidth is  $11.8 \cdot 10^{-6} \cdot f_{\text{EOSC}}$ .

Due to the complex filtering and calibration algorithms utilized, the converter input bandwidth is not modeled very accurately by a first order filter with the pole located at the 3dB frequency. When the internal oscillator is used, the shape of the LTC2483 input bandwidth is shown in Figure 24. When an external oscillator of frequency  $f_{\text{EOSC}}$  is used, the shape of the LTC2483 input bandwidth can be derived from Figure 24, in which the horizontal axis is scaled by  $f_{\text{EOSC}}/279.2\text{kHz}$ .

The conversion noise ( $600\text{nV}_{\text{RMS}}$  typical for  $V_{\text{REF}} = 5\text{V}$ ) can be modeled by a white noise source connected to a noise free converter. The noise spectral density is  $47\text{nV}\sqrt{\text{Hz}}$  for an infinite bandwidth source and  $64\text{nV}\sqrt{\text{Hz}}$  for a single 0.5MHz pole source. From these numbers, it is clear that particular attention must be given to the design of external amplification circuits. Such circuits face the simultaneous requirements of very low bandwidth (just a few Hz) in order to reduce the output referred noise and relatively high bandwidth (at least 500kHz) necessary to drive the input switched-capacitor network. A possible solution is a high gain, low bandwidth amplifier stage followed by a high bandwidth unity-gain buffer.

When external amplifiers are driving the LTC2483, the ADC input referred system noise calculation can be simplified by Figure 25. The noise of an amplifier driving the LTC2483 input pin can be modeled as a band limited white noise source. Its bandwidth can be approximated by the bandwidth of a single pole lowpass filter with a corner frequency  $f_i$ . The amplifier noise spectral density is  $n_i$ . From Figure 25, using  $f_i$  as the x-axis selector, we can find on the y-axis the noise equivalent bandwidth  $\text{freq}_i$  of the input driving amplifier. This bandwidth includes the band limiting effects of the ADC internal calibration and filtering. The noise of the driving amplifier referred to the converter input and including all these

effects can be calculated as  $N = n_i \cdot \sqrt{\text{freq}_i}$ . The total system noise (referred to the LTC2483 input) can now be obtained by summing as square root of sum of squares the three ADC input referred noise sources: the LTC2483 internal noise, the noise of the IN<sup>+</sup> driving amplifier and the noise of the IN<sup>-</sup> driving amplifier.

If the CA0/F<sub>0</sub> pin is driven by an external oscillator of frequency  $f_{\text{EOSC}}$ , Figure 25 can still be used for noise calculation if the x-axis is scaled by  $f_{\text{EOSC}}/307200$ . For large values of the ratio  $f_{\text{EOSC}}/307200$ , the Figure 25 plot accuracy begins to decrease, but at the same time the LTC2483 noise floor rises and the noise contribution of the driving amplifiers lose significance.

### Normal Mode Rejection and Antialiasing

One of the advantages delta-sigma ADCs offer over conventional ADCs is on-chip digital filtering. Combined with a large oversampling ratio, the LTC2483 significantly simplifies antialiasing filter requirements. Additionally, the input current cancellation feature of the LTC2483 allows external lowpass filtering without degrading the DC performance of the device.

The SINC<sup>4</sup> digital filter provides greater than 120dB normal mode rejection at all frequencies except DC and integer multiples of the modulator sampling frequency ( $f_s$ ). The LTC2483's autocalibration circuits further simplify the antialiasing requirements by additional normal mode signal filtering both in the analog and digital domain. Independent of the operating mode,  $f_s = 256 \cdot f_N = 2048 \cdot f_{\text{OUTMAX}}$  where  $f_N$  is the notch frequency and  $f_{\text{OUTMAX}}$  is the maximum output data rate. In the internal oscillator mode,  $f_s = 13960\text{Hz}$ . In the external oscillator mode,  $f_s = f_{\text{EOSC}}/20$ . The performance of the normal mode rejection is shown in Figures 26 and 27.

The regions of low rejection occurring at integer multiples of  $f_s$  have a very narrow bandwidth. Magnified details of the normal mode rejection curves are shown in Figure 28 (rejection near DC) and Figure 29 (rejection at  $f_s = 256f_N$ ) where  $f_N$  represents the notch frequency. These curves have been derived for the external oscillator mode but they can be used in all operating modes by appropriately selecting the  $f_N$  value.



# APPLICATIONS INFORMATION

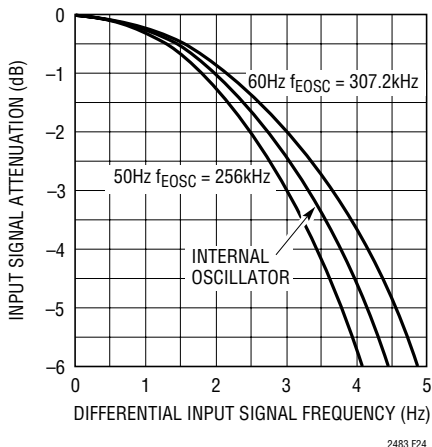

Figure 24. Input Signal Using the Internal Oscillator

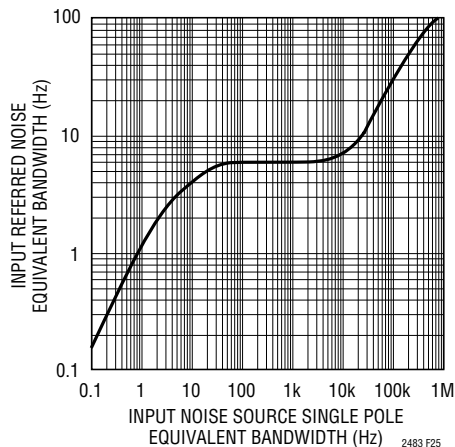

Figure 25. Input Referred Noise Equivalent Bandwidth of an Input Connected White Noise Source

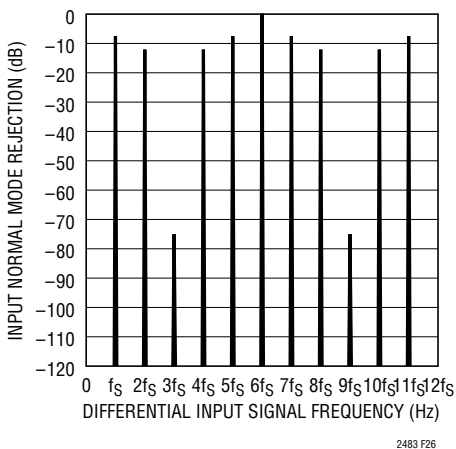

Figure 26. Input Normal Mode Rejection, External Oscillator ( $f_{EOSC} = 256\text{kHz}$ ) 50Hz Rejection

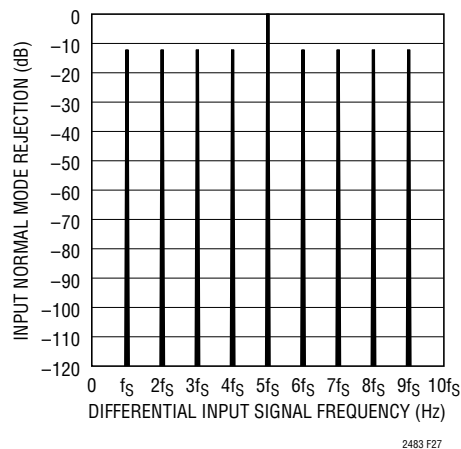

Figure 27. Input Normal Mode Rejection at DC (Internal Oscillator)

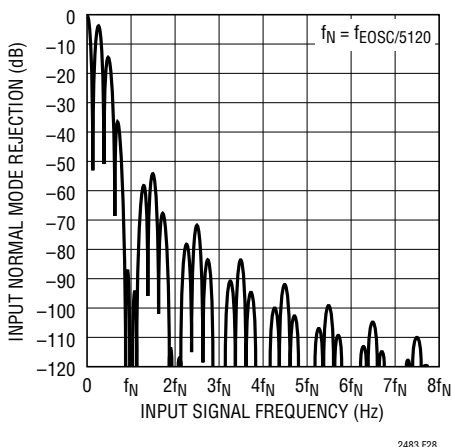

Figure 28. Input Normal Mode Rejection at DC

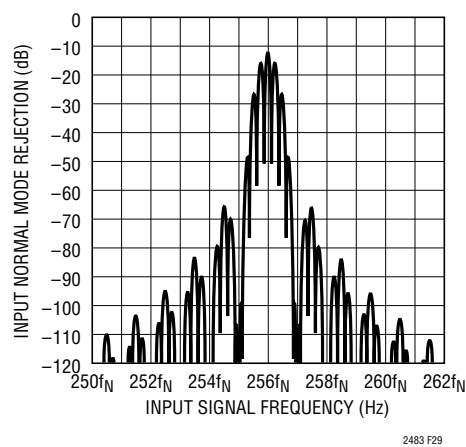

Figure 29. Input Normal Mode Rejection at  $f_S = 256f_N$

## APPLICATIONS INFORMATION

The user can expect to achieve this level of performance using the internal oscillator as it is demonstrated by Figures 30, 31 and 32. Typical measured values of the normal mode rejection of the LTC2483 operating with an external oscillator and a 60Hz notch setting are shown in Figure 30 superimposed over the theoretical calculated curve. Similarly, the measured normal rejection of the LTC2483 for 50Hz rejection ( $f_{\text{EOSC}} = 256\text{kHz}$ ) and 50Hz/60Hz rejection (internal oscillator) are shown in Figures 31 and 32.

As a result of these remarkable normal mode specifications, minimal (if any) antialias filtering is required in front of the LTC2483. If passive RC components are placed in front of the LTC2483, the input dynamic current should be considered (see Input Current section). In this case, the differential input current cancellation feature of the LTC2483 allows external RC networks without significant degradation in DC performance.

Traditional high order delta-sigma modulators, while providing very good linearity and resolution, suffer from potential instabilities at large input signal levels. The proprietary architecture used for the LTC2483 third order modu-

lator resolves this problem and guarantees a predictable stable behavior at input signal levels of up to 150% of full scale. In many industrial applications, it is not uncommon to have to measure microvolt level signals superimposed on volt level perturbations and the LTC2483 is eminently suited for such tasks. When the perturbation is differential, the specification of interest is the normal mode rejection for large input signal levels. With a reference voltage  $V_{\text{REF}} = 5\text{V}$ , the LTC2483 has a full-scale differential input range of 5V peak-to-peak. Figures 33 and 34 show measurement results for the LTC2483 normal mode rejection ratio with a 7.5V peak-to-peak (150% of full scale) input signal superimposed over the more traditional normal mode rejection ratio results obtained with a 5V peak-to-peak (full scale) input signal. In Figure 33, the LTC2483 uses the external oscillator with the notch set at 60Hz and in Figure 34 it uses the external oscillator with the notch set at 50Hz. It is clear that the LTC2483 rejection performance is maintained with no compromises in this extreme situation. When operating with large input signal levels, the user must observe that such signals do not violate the device absolute maximum ratings.

# APPLICATIONS INFORMATION

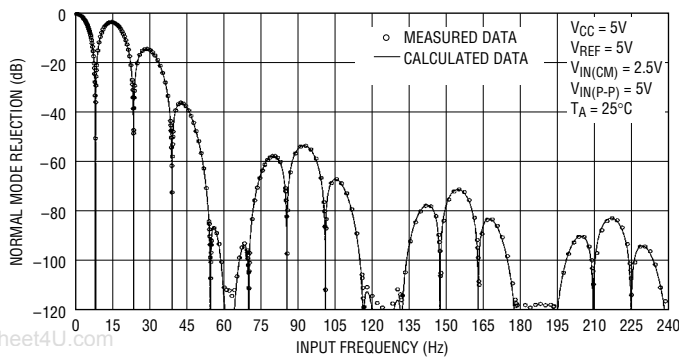

**Figure 30. Input Normal Mode Rejection vs Input Frequency with Input Perturbation of 100% Full Scale (60Hz Notch  $f_{EOSC} = 307.2\text{kHz}$ )**

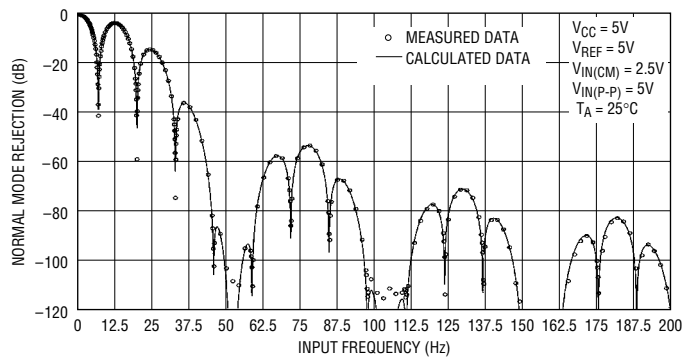

**Figure 31. Input Normal Mode Rejection vs Input Frequency with Input Perturbation of 100% Full Scale (50Hz Notch  $f_{EOSC} = 256\text{kHz}$ )**

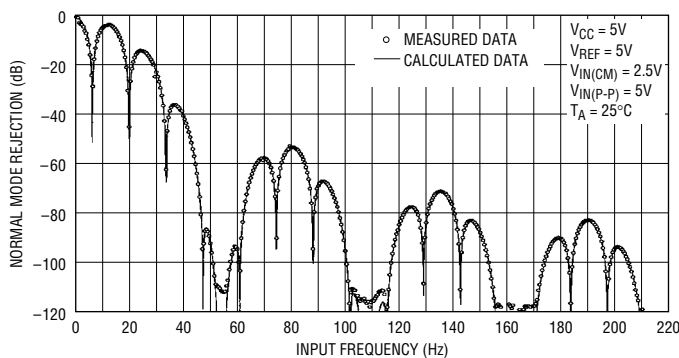

**Figure 32. Input Normal Mode Rejection vs Input Frequency with Input Perturbation of 100% Full Scale (Internal Oscillator)**

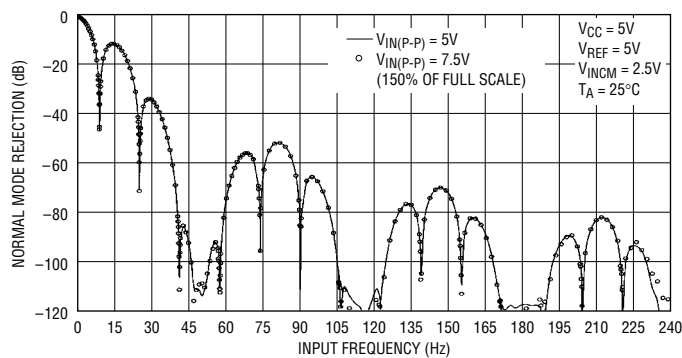

**Figure 33. Measured Input Normal Mode Rejection vs Input Frequency with Input Perturbation of 150% Full Scale (60Hz Notch  $f_{EOSC} = 307.2\text{kHz}$ )**

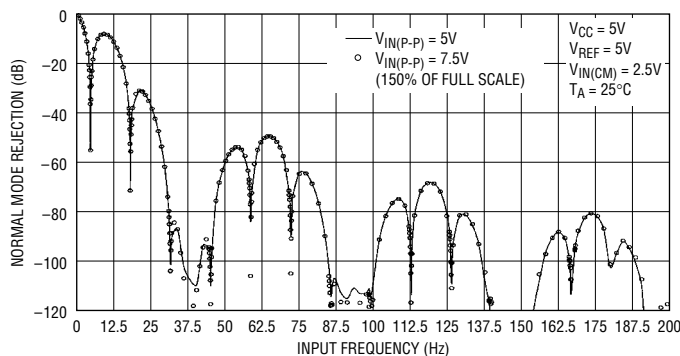

**Figure 34. Measured Input Normal Mode Rejection vs Input Frequency with Input Perturbation of 150% Full Scale (50Hz Notch  $f_{EOSC} = 256\text{kHz}$ )**

## APPLICATIONS INFORMATION

```

/*
LTC248X.h
Processor setup and
Lots of useful defines for configuring the LTC2481, LTC2483, and LTC2485.
*/

#include <16F73.h> // Device
#include <delay.h> // 6MHz clock
#include <fuses.h> // Configuration fuses
#include <rom.h> // Equivalent and more reliable fuse config.

#include <I2C.h> // Set up i2c port
#include "PCM73A.h" // Various defines
#include "lcd.c" // LCD driver functions

#define READ 0x01 // bitwise OR with address for read or write
#define WRITE 0x00
#define LTC248XADDR 0b01001000 // The one and only LTC248X in this circuit,
// with both address lines floating.

// Useful defines for the LTC2481 and LTC2485 - OR them together to make the
// 8 bit config word.
// These do NOT apply to the LTC2483.

// Select gain - 1 to 256 (also depends on speed setting)
// Does NOT apply to LTC2485.
#define GAIN1 0b00000000 // G = 1 (SPD = 0), G = 1 (SPD = 1)
#define GAIN2 0b00100000 // G = 4 (SPD = 0), G = 2 (SPD = 1)
#define GAIN3 0b01000000 // G = 8 (SPD = 0), G = 4 (SPD = 1)
#define GAIN4 0b01100000 // G = 16 (SPD = 0), G = 8 (SPD = 1)
#define GAIN5 0b10000000 // G = 32 (SPD = 0), G = 16 (SPD = 1)
#define GAIN6 0b10100000 // G = 64 (SPD = 0), G = 32 (SPD = 1)
#define GAIN7 0b11000000 // G = 128 (SPD = 0), G = 64 (SPD = 1)
#define GAIN8 0b11100000 // G = 256 (SPD = 0), G = 128 (SPD = 1)

// Select ADC source - differential input or PTAT circuit
#define VIN 0b00000000
#define PTAT 0b00001000

// Select rejection frequency - 50, 55, or 60Hz
#define R50 0b00000010
#define R55 0b00000000
#define R60 0b00000100

// Select speed mode
#define SLOW 0b00000000 // slow output rate with autozero
#define FAST 0b00000001 // fast output rate with no autozero

```

## APPLICATIONS INFORMATION

```
/*
LTC2483.c
Basic voltmeter test program for LTC2483
Reads LTC2483, converts result to volts,
and prints voltage to a 2 line by 16 character LCD display.
```

```
Mark Thoren
Linear Technonlgy Corporation
June 23, 2005
```

```
Written for CCS PCM compiler, Version 3.182
```

```
*/
```

```
#include "LTC248X.h"
/**** read_LTC2483() ****
This is the functiton that actually does all the work of talking to the LTC2483.
```

```
Arguments:  addr - device address
```

```
Returns:    zero if conversion is in progress,
            32 bit signed integer with lower 8 bits clear, 24 bit LTC2483
            output word in the upper 24 bits. Data is left-justified for
            compatibility with the 24 bit LTC2485.
```

the i2c\_xxxx() functions do the following:

```
void i2c_start(void): generate an i2c start or repeat start condition
void i2c_stop(void): generate an i2c stop condition
char i2c_read(boolean): return 8 bit i2c data while generating an ack or nack
boolean i2c_write(): send 8 bit i2c data and return ack or nack from slave device
```

These functions are very compiler specific, and can use either a hardware i2c port or software emulation of an i2c port. This example uses software emulation.

A good starting point when porting to other processors is to write your own i2c functions. Note that each processor has its own way of configuring the i2c port, and different compilers may or may not have built-in functions for the i2c port.

When in doubt, you can always write a "bit bang" function for troubleshooting purposes.

The "fourbytes" structure allows byte access to the 32 bit return value:

```
struct fourbytes // Define structure of four consecutive bytes
{
    // To allow byte access to a 32 bit int or float.
    int8 te0; //
    int8 te1; // The make32() function in this compiler will
    int8 te2; // also work, but a union of 4 bytes and a 32 bit int
    int8 te3; // is probably more portable.
};
*****/
signed int32 read_LTC2483(char addr)
{
    struct fourbytes // Define structure of four consecutive bytes
    {
        // To allow byte access to a 32 bit int or float.
        int8 te0; //
        int8 te1; // The make32() function in this compiler will
        int8 te2; // also work, but a union of 4 bytes and a 32 bit int
        int8 te3; // is probably more portable.
    };
```

## APPLICATIONS INFORMATION

```

union          // adc_code.bits32    all 32 bits
{
    signed int32 bits32; // adc_code.by.te0    byte 0
    struct fourbytes by; // adc_code.by.te1    byte 1
    } adc_code; // adc_code.by.te2    byte 2
                // adc_code.by.te3    byte 3

// Start communication with LTC2483:
i2c_start();
if(i2c_write(addr | READ))// If no acknowledge, return zero
{
    i2c_stop();
    return 0;
}
adc_code.by.te3 = i2c_read();
adc_code.by.te2 = i2c_read();
adc_code.by.te1 = i2c_read();
adc_code.by.te0 = 0;
i2c_stop();
return adc_code.bits32;
} // End of read_LTC2483()

/** initialize() ****
Basic hardware initialization of controller and LCD, send Hello message to LCD
*****/
void initialize(void)
{
    // General initialization stuff.
    setup_adc_ports(NO_ANALOGS);
    setup_adc(ADC_OFF);
    setup_counters(RTCC_INTERNAL,RTCC_DIV_1);
    setup_timer_1(T1_DISABLED);
    setup_timer_2(T2_DISABLED,0,1);

// This is the important part - configuring the SPI port
setup_spi(SPI_MASTER|SPI_L_TO_H|SPI_CLK_DIV_16|SPI_SS_DISABLED); // fast SPI clock
CKP = 0; // Set up clock edges - clock idles low, data changes on
CKE = 1; // falling edges, valid on rising edges.

    lcd_init(); // Initialize LCD
    delay_ms(6);
    printf(lcd_putc, "Hello!"); // Obligatory hello message
    delay_ms(500); // for half a second
} // End of initialize()

/** main() ****
Main program initializes microcontroller registers, then reads the LTC2483
repeatedly
*****/
void main()
{
    signed int32 x; // Integer result from LTC2481
    float voltage; // Variable for floating point math
    int16 timeout;
    initialize(); // Hardware initialization
    while(1)
    {
        delay_ms(1); // Pace the main loop to something more than 1 ms
// This is a basic error detection scheme. The LTC2483 will never take more than
// 149.9ms to complete a conversion in the 55Hz
// rejection mode.

```

## APPLICATIONS INFORMATION

```
// If read_LTC2483() does not return non-zero within this time period, something
// is wrong, such as an incorrect i2c address or bus conflict.
```

```
if((x = read_LTC2483(LTC248XADDR)) != 0)
{
  // No timeout, everything is okay
  timeout = 0;           // reset timer
  x ^= 0x80000000;      // Invert MSB, result is 2's complement
  voltage = (float) x;  // convert to float
  voltage = voltage * 5.0 / 2147483648.0; // Multiply by Vref, divide by 2^31
  lcd_putc('\f');      // Clear screen
  lcd_gotoxy(1,1);    // Goto home position
  printf(lcd_putc, "V %01.4f", voltage); // Display voltage
}
else
{
  ++timeout;
}
if(timeout > 200)
{
  timeout = 200;      // Prevent rollover
  lcd_gotoxy(1,1);
  printf(lcd_putc, "ERROR - TIMEOUT");
  delay_ms(500);
}
} // End of main loop
} // End of main()
```

## PACKAGE DESCRIPTION

**DD Package**  
**10-Lead Plastic DFN (3mm × 3mm)**  
 (Reference LTC DWG # 05-08-1698)

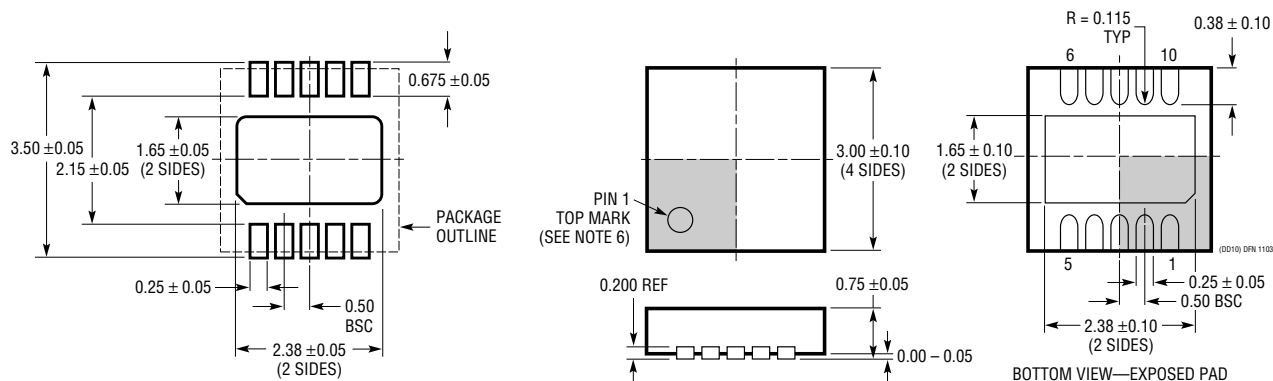

**RECOMMENDED SOLDER PAD PITCH AND DIMENSIONS**

**NOTE:**

- DRAWING TO BE MADE A JEDEC PACKAGE OUTLINE M0-229 VARIATION OF (WEED-2). CHECK THE LTC WEBSITE DATA SHEET FOR CURRENT STATUS OF VARIATION ASSIGNMENT
- DRAWING NOT TO SCALE
- ALL DIMENSIONS ARE IN MILLIMETERS
- DIMENSIONS OF EXPOSED PAD ON BOTTOM OF PACKAGE DO NOT INCLUDE MOLD FLASH. MOLD FLASH, IF PRESENT, SHALL NOT EXCEED 0.15mm ON ANY SIDE
- EXPOSED PAD SHALL BE SOLDER PLATED
- SHADED AREA IS ONLY A REFERENCE FOR PIN 1 LOCATION ON THE TOP AND BOTTOM OF PACKAGE

TYPICAL APPLICATION

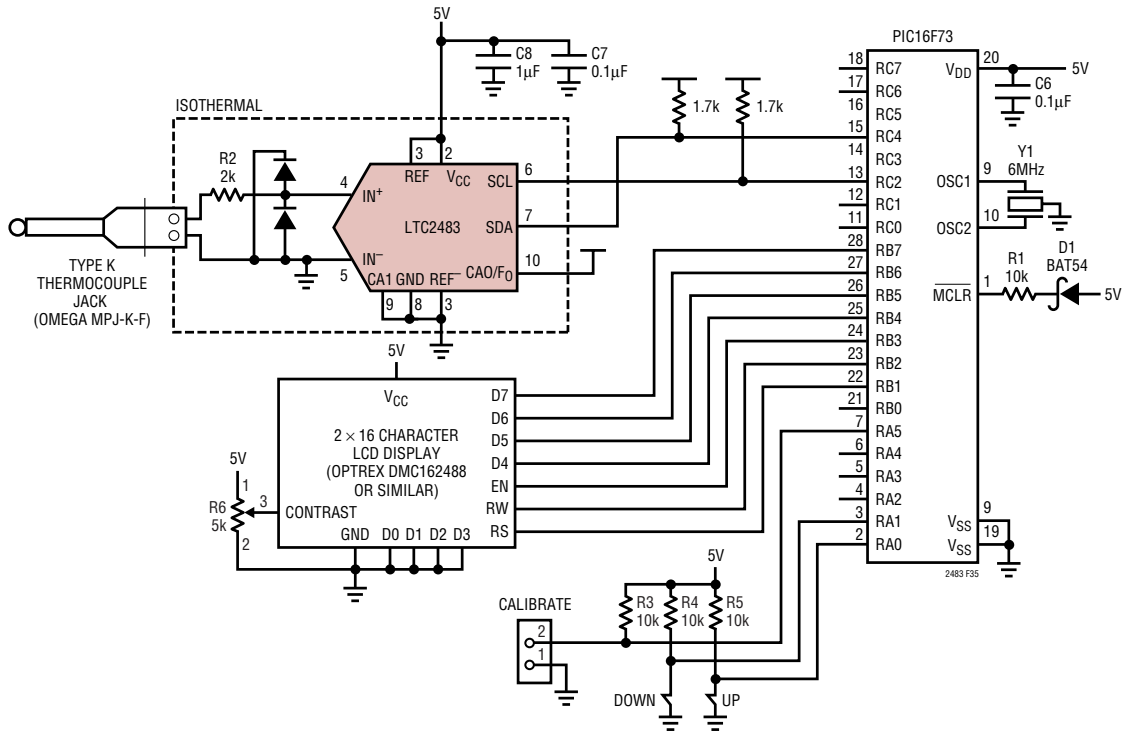

Figure 35. Voltage Measurement Circuit

RELATED PARTS

PART NUMBER	DESCRIPTION	COMMENTS
LT1236A-5	Precision Bandgap Reference, 5V	0.05% Max Initial Accuracy, 5ppm/°C Drift
LT1460	Micropower Series Reference	0.075% Max Initial Accuracy, 10ppm/°C Max Drift
LT1790	Micropower SOT-23 Low Dropout Reference Family	0.05% Max Initial Accuracy, 10ppm/°C Max Drift
LTC2400	24-Bit, No Latency $\Delta\Sigma$ ADC in SO-8	0.3ppm Noise, 4ppm INL, 10ppm Total Unadjusted Error, 200 $\mu$ A
LTC2410	24-Bit, No Latency $\Delta\Sigma$ ADC with Differential Inputs	0.8 $\mu$ V <sub>RMS</sub> Noise, 2ppm INL
LTC2411/LTC2411-1	24-Bit, No Latency $\Delta\Sigma$ ADCs with Differential Inputs in MSOP	1.45 $\mu$ V <sub>RMS</sub> Noise, 4ppm INL, Simultaneous 50Hz/60Hz Rejection (LTC2411-1)
LTC2413	24-Bit, No Latency $\Delta\Sigma$ ADC with Differential Inputs	Simultaneous 50Hz/60Hz Rejection, 800nV <sub>RMS</sub> Noise
LTC2415/LTC2415-1	24-Bit, No Latency $\Delta\Sigma$ ADCs with 15Hz Output Rate	Pin Compatible with the LTC2410
LTC2414/LTC2418	8-/16-Channel 24-Bit, No Latency $\Delta\Sigma$ ADCs	0.2ppm Noise, 2ppm INL, 3ppm Total Unadjusted Errors 200 $\mu$ A
LTC2440	High Speed, Low Noise 24-Bit $\Delta\Sigma$ ADC	3.5kHz Output Rate, 200nV Noise, 24.6 ENOBs
LTC2480	16-Bit $\Delta\Sigma$ ADC with Easy Drive Inputs, 600nV Noise, Programmable Gain, and Temperature Sensor	Pin Compatible with LTC2482/LTC2484
LTC2481	16-Bit $\Delta\Sigma$ ADC with Easy Drive Inputs, 600nV Noise, I <sup>2</sup> C Interface, Programmable Gain, and Temperature Sensor	Pin Compatible with LTC2483/LTC2485
LTC2482	16-Bit $\Delta\Sigma$ ADC with Easy Drive Inputs	Pin Compatible with LTC2480/LTC2484
LTC2484	24-Bit $\Delta\Sigma$ ADC with Easy Drive Inputs	Pin Compatible with LTC2480/LTC2482
LTC2485	24-Bit $\Delta\Sigma$ ADC with Easy Drive Inputs, I <sup>2</sup> C Interface and Temperature Sensor	Pin Compatible with LTC2481/LTC2483